

AUTOMATIONBOOK

ifm electronic



ifm – close to you!

visit our website:

www.ifm.com

Over 70 locations worldwide – at a glance at www.ifm.com



ifm electronic gmbh
Friedrichstraße 1
45128 Essen
Tel. +49 / 201 / 24 22-0
Fax +49 / 201 / 24 22-1200
E-Mail: info@ifm.com





<i>ifm – the company</i>	6 - 7	
<i>General information</i>	8 - 9	
<i>Standards and approvals / list of articles</i>	10 - 56	
<i>Sensors for special applications</i>	57 - 61	
<i>Position sensors</i>	62 - 328	
<i>Sensors for motion control</i>	330 - 365	
<i>Industrial imaging</i>	366 - 386	
<i>Safety technology</i>	388 - 433	
<i>Process sensors</i>	434 - 583	
<i>Industrial communication</i>	584 - 634	
<i>Identification systems</i>	636 - 660	
<i>Condition monitoring systems</i>	662 - 680	
<i>Systems for mobile machines</i>	682 - 735	
<i>Connection technology</i>	736 - 828	
<i>Power supplies</i>	830 - 840	
<i>ifm – worldwide addresses</i>	842 - 845	

The company in your vicinity.



State-of-the-art communication.

With the right address – www.ifm.com – only a mouse click separates you from the world of automation technology. See the power of our products in interactive representations. Gain an impression with 3-dimensional views of our units. Download CAD drawings for direct integration in your applications. Or order online in ifm's e-shop – fast, convenient and reliable.

We are there for you.

Close contact with our customers is part of our success. Therefore we have consistently developed our sales network right from the start. Today the ifm group of companies is represented in more than 70 countries – close to you! With application advice and service at the heart of our operation. For the introduction of new products and technologies we support you with workshops and seminars in our training centres or in your plant.

Security by success.

Since its foundation in 1969 ifm has constantly grown, now having more than 5500 employees worldwide, and achieved a turnover of more than EUR 720 million in 2015. This success gives you the security of having a reliable partner for the implementation of your automation projects. Comprehensive service and a warranty of 5 years on standard units are just two examples of this reliability.

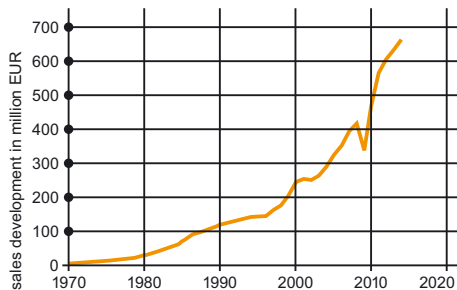

Turnover development since 1970.



Not only components.

ifm stands for a large range of different sensors and systems for automation. Our range of more than 7,800 articles guarantees flexibility and compatibility. So there is always a reliable solution for your automation projects – from the individual sensor with practical accessories to the complete system.

Availability guaranteed.

Your deadlines matter to us. That is why we are constantly optimising our production processes in order to be able to quickly and flexibly produce large quantities at a constantly high quality – and to continue to shorten delivery times. Your order is dispatched via our centralised logistics centre reliably and on time.

Quality as part of our philosophy.

The quality standard of our products is an integral part of our company philosophy. And we guarantee it! So we provide you, the users, with a maximum degree of security: By means of our own production technology, ifm film technology, as well as by means of extensive quality assurance measures such as 100 % final testing. By quality we understand, for example, ecologically conscious production – Made in Germany!



The development of innovative products is one of our core competences. From high-quality standard solutions to products specially tailored to the requirements of the individual industries – from mobile machines to the food industry.

www.ifm.com Information around the clock and around the globe in 23 languages on the internet.

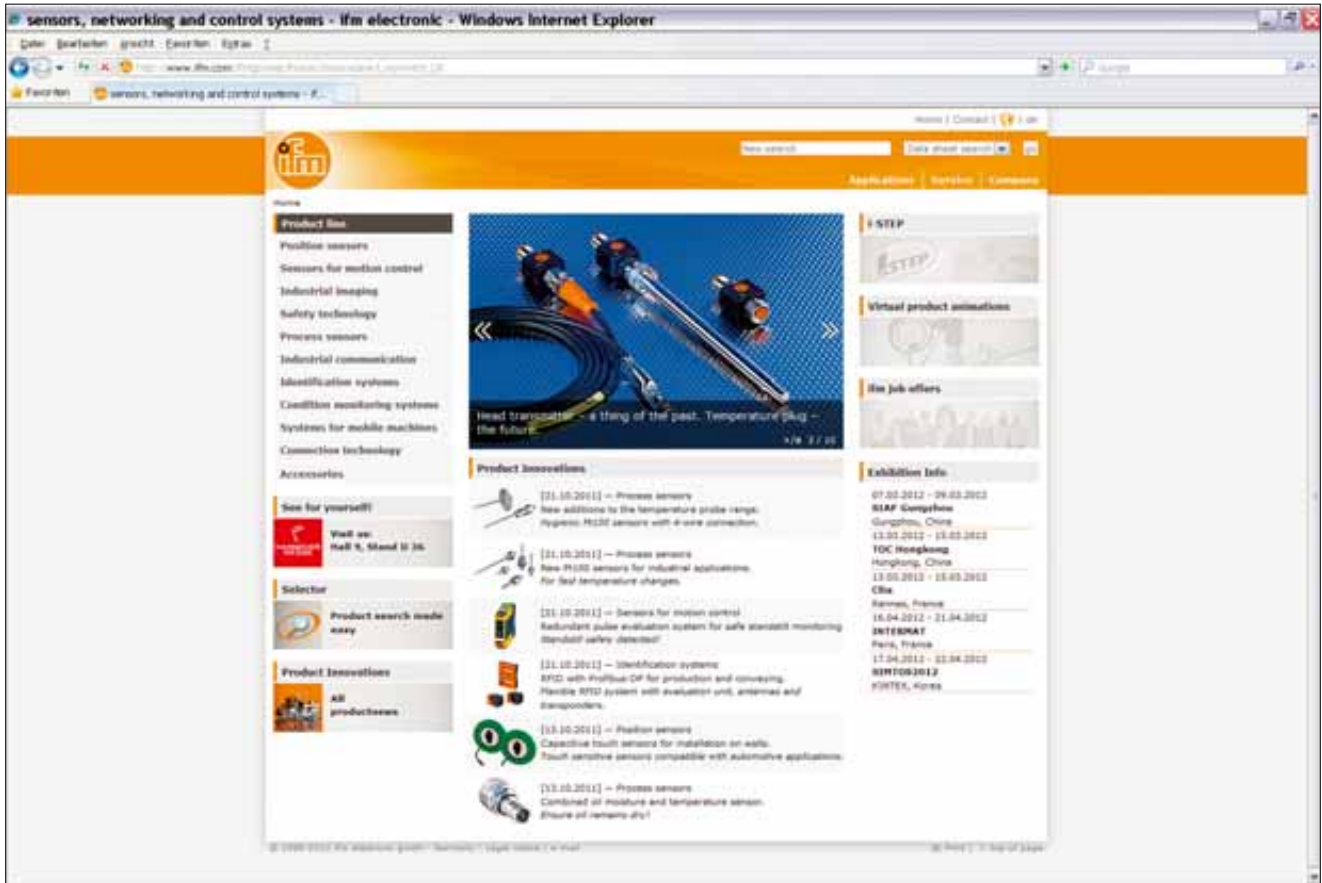

• **Information**

- product innovations
- company news
- exhibition info
- locations
- jobs

• **Documentation**

- data sheets
- operating instructions
- manuals
- approvals
- CAD data

• **Communication***

- request for documents
- recall service
- live advice
- newsletter

• **Selection**

- interactive product selection aids
- configuration tools
- data sheet direct

• **Animation**

- virtual product animations
- flash movies (video sequences)

• **Application**

- applications
- product recommendations
- calculation aids

• **Transaction***

- e-shop processing
- e-procurement catalogues

*Some offered information is available country-specific

Convenient order processing via the e-shop** on the internet.

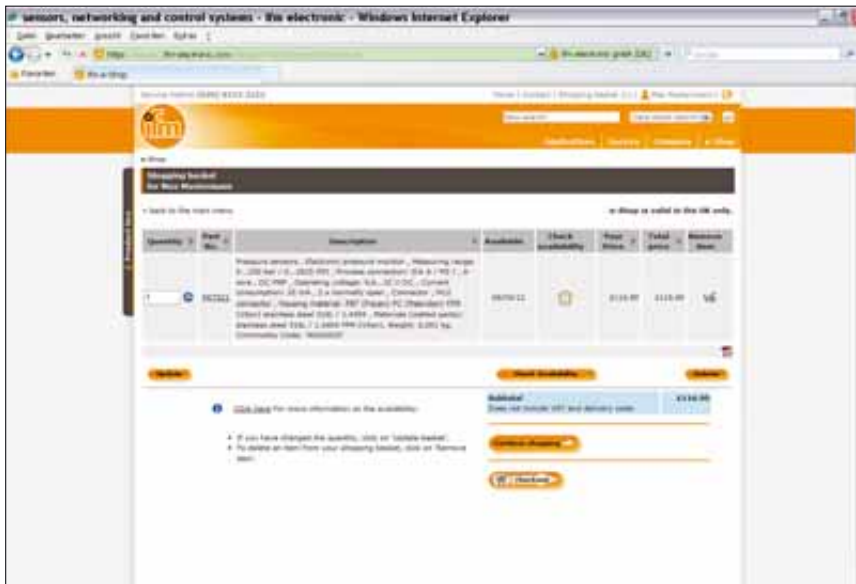

Secured authentication

Customer-related price indication

Real time availability check

Personal product favourites

Online parcel tracking

Individual order history

Convenient quick input form

Simple order processing

Management of shipping addresses

Confirmations by e-mail



ifm application database

ifm's automation technology is used to for applications in many different types of plant in almost all industries. Learn how ifm can improve your production.

Application examples can be found on our website at:

www.ifm.com/gb/applications

** Already available in many countries.

3A



3A Sanitary Standards, Inc. (3-A SSI) is an independent, not-for-profit corporation dedicated to advancing hygienic equipment design for the food, beverage, and pharmaceutical industries.

AS-i



Actuator-Sensor Interface. Bus system for the first binary field level.

ATEX



Atmosphère Explosible. ATEX comprises the directives of the European Union in the field of explosion protection. On the one hand there is the 94/9/EC ATEX product directive and on the other hand the 1999/92/EC ATEX operation directive.

CCC



CCC (China Compulsory Certification) is a compulsory Chinese certification for certain products put on the market in China. Which products are concerned is specified in a catalogue created by the Chinese authorities.

cCSAus



Testing of a product by CSA according to the safety standards applicable in Canada and the USA.

CE



Conformité Européenne. By affixing the CE marking to a product, the manufacturer declares that it meets EU safety, health and environmental requirements.

cRUus



Testing of components by UL according to the safety standards applicable in Canada and the USA. Components can be used when the "condition of acceptability" is complied with for the final product.

CSA



Canadian Standards Association. A non-governmental Canadian organisation that sets standards and tests and certifies products for their reliability. By now it is active worldwide.

cULus



Testing of components by UL according to the safety standards applicable in Canada and the USA.

DIBt (WHG)



Deutsches Institut für Bautechnik (Federal Water Act). The Federal Water Act (WHG) is the essential part of the German law relating to water. It contains provisions for the protection and use of surface water and ground water and also regulations about the expansion of waters, water planning and flood protection.

DKD



The Deutscher Kalibrierdienst (DKD) is an association of calibration laboratories of industrial firms, research institutes, technical authorities, inspection and testing institutes. The DKD calibration certificates prove traceability to national standards as required in ISO 9000 and ISO / IEC 17025. They also serve as a metrological basis for the control of measurement and test equipment within the framework of quality management.

E1



Approval by the Kraftfahrt-Bundesamt (German Federal Motor Transport Authority). The E1 type approval by the German Federal Motor Transport Authority certifies that the units comply with the automotive standards. Units with this marking are allowed to be mounted on vehicles without expiry of their operating permit.

EG 1935/2004

The Regulation EC 1935/2004 has been taken into account for process sensors from ifm which are intended for use in contact with food. You can obtain a list of the corresponding products and detailed information on request.

EHEDG



European Hygienic Engineering & Design Group. European supervisory authority for food and drugs. This authority grants approvals for products and materials used in the food and pharmaceutical industries.

FDA



Food and Drug Administration. US-American supervisory authority for food and drugs. This authority grants approvals for products and materials used in the food and pharmaceutical industries.

FM



Factory Mutual Research. A US-based insurance company that specializes in loss prevention services in the property insurance market sector. They provide material research, material testing and certifications in the field of fire and explosion protection.

PROFIBUS



Process Field Bus. Fieldbus system for important data quantities. It is available in several versions such as Profibus FMS, DP or PA. Profibus DP can be used over longer distances, e.g. as fieldbus for AS-i.

TÜV



Technischer Überwachungs Verein (technical inspection association). The German TÜV is a private-sector body carrying out technical safety tests that are stipulated by government laws or instructions.

UL



Underwriters Laboratories. An organisation founded in the USA for testing and certifying products and their safety.

Order no.	Approvals	Catalogue page	Order no.	Approvals	Catalogue page
AC0017	CE	318, 576	AC1366	CE, CUL	586
AC0019	CE	318, 576	AC1375	CE, CUL	587
AC0015	CE, CUL	428, 628	AC1376	CE, CUL	587
AC0020	CE	318, 576	AC1401	CE, CUL, PI	587
AC0021	CE	318, 576	AC1402	CE, CUL, PI	587
AC0022	CE	318, 576	AC1411	CE, CUL, PI	587
AC0023	CE	318, 576	AC1412	CE, CUL, PI	587
AC0025	CE, CUL	428, 628	AC1421	CE, CUL	587
AC0035	CE, CUL	428, 628	AC1422	CE, CUL	588
AC0045	CE, CUL	428, 628	AC2032	CE	602
AC0065	CE	429, 629	AC2035	CE	602
AC0075	CE, CUL	428, 628	AC2055	CE, CUL	616
AC0095	CE, CRUUS	428, 628	AC2057	CE	616
AC0105	CE, CUL	429, 629	AC2086	CE	598
AC0115	CE	431, 588	AC2087	CE	598
AC0116	CE	431, 588	AC2088	CE	598
AC0115	CE, CUL	429, 629	AC2211	CE	592
AC0125	CE, CUL	429, 629	AC2212	CE	592
AC0155	CE, CRUUS	429, 629	AC2216	CE, CUL	595
AC0165	CE, CUL	429, 629	AC2217	CE, CUL	595
AC0305	CE, CUL	428, 628	AC2218	CE, CUL	596
AC0325	CE, CUL	428, 628	AC2219	CE, CUL	596
AC0340		587	AC2220	CE, CUL	596
AC0350		631	AC2225	CE, CUL	626
AC0351		631	AC2250	CE, CRUUS	595
AC0352		631	AC2251	CE, CRUUS	595
AC0415	CE, CUL	428, 628	AC2252	CE, CRUUS	595
AC1145	CE	626	AC2254	CE, CRUUS	595
AC1146	CE, CUL	626	AC2255	CE, CRUUS	595
AC1147	CE, CUL	626	AC2256	CE, CRUUS	595
AC1154	CE	606	AC2257	CE, CRUUS	595
AC1220	CE, CRUUS, CUL	838	AC2258	CE, CRUUS	596
AC1221	CE, CRUUS, CUL	838	AC2259	CE, CRUUS	596
AC1250	CE, CRUUS	588	AC2264	CE, CRUUS	595
AC1253	CE, CRUUS, CUL	592, 839	AC2267	CE, CRUUS	595
AC1254	CE, CRUUS, CUL	592, 838	AC2310	CE, CUL	622
AC1256	CE, CRUUS, CUL	592, 838	AC2315	CE, CUL	315, 573
AC1257	CE, CUL	592, 839	AC2316	CE, CUL	315, 573
AC1258	CE, CRUUS, CUL	592, 838	AC2317	CE, CUL	315, 573
AC1318	CE, CUL	586	AC2402	CE, CUL	600
AC1324	CE, CUL	586	AC2403	CE, CUL	600
AC1327	CE, CUL	586	AC2410	CE, CUL	600
AC1331	CE, CUL	586	AC2411	CE, CUL	600
AC1332	CE, CUL	587	AC2412	CE, CUL	600
AC1337	CE, CUL	586	AC2413	CE, CUL	600
AC1355	CE, CUL	586	AC2417	CE, CUL	600
AC1356	CE, CUL	586	AC2451	CE, CUL	600
AC1357	CE, CUL	587	AC2452	CE, CUL	601
AC1358	CE, CUL	587	AC2457	CE, CUL	600
AC1365	CE, CUL	586	AC2458	CE, CUL	600

Order no.	Approvals	Catalogue page	Order no.	Approvals	Catalogue page
AC2459	CE, CUL	600	AC5007		606
AC2464	CE, CUL	601	AC5010	CUL	603
AC2465	CE, CUL	601	AC5011	CUL	603
AC2466	CE, CUL	601	AC5014	CUL	603
AC246A	CE	615	AC5015		603
AC2471	CE, CUL	601	AC505A	CE	599
AC2482	CE, CUL	601	AC5055	CE, CUL	429, 629
AC2484	CE, CUL	601	AC5065	CE, CUL	429, 629
AC2488	CE, CUL	601	AC507A	CE	599
AC2516	CE, CUL	598	AC508A	CE	599
AC2517	CE, CUL	598	AC514A	CE	599
AC2616	CE	602	AC515A	CE	599
AC2617	CE	602	AC5200	CE, CUL	597
AC2618	CE	602	AC5203	CE, CUL	597
AC2619	CE	602	AC5204	CE, CUL	598
AC2620	CE	602	AC5205	CE, CUL	597
AC2625	CE	601	AC5208	CE, CUL	597
AC2630	CE	601	AC5209	CE, CUL	598
AC2631	CE	602	AC5210	CE, CUL	598
AC2634	CE	602	AC5211	CE, CUL	597
AC2636	CE	602	AC5212	CE, CUL	598
AC2637	CE	602	AC5213	CE, CUL	597
AC2638	CE	602	AC5214	CE, CUL	597
AC2709	CE, CRUUS	596	AC5215	CE, CUL	597
AC2729	CE, CRUUS	596	AC5216	CE, CUL	597
AC2731	CE	596	AC5222	CE, CUL	598
AC2739	CE, CRUUS	596	AC5223	CE, CUL	599
AC2750	CE, CRUUS	596	AC5224	CE, CUL	597
AC2751	CE, CRUUS	596	AC5225	CE, CUL	599
AC2752	CE, CRUUS	596	AC5226	CE, CUL	599
AC2753	CE, CRUUS	596	AC5227	CE, CUL	614
AC2900	CE, CUL	603	AC5228	CE, CUL	614
AC2904	CE, CUL	603	AC522A	CE	599
AC2910	CE, CUL	603	AC5230	CE, CUL	599
AC2916	CE, CUL	603	AC5235	CE, CUL	598
AC2923	CE, CUL	603	AC5236	CE, CUL	598
AC3000		606	AC5243	CE, CUL	614
AC315A	CE	575	AC5246	CE, CUL	614
AC316A	CE	575	AC5249	CE, CUL	614
AC317A	CE	575	AC5251	CE, CUL	614
AC3200	CE, CUL	596	AC5253	CE, CUL	615
AC3201	CE, CUL	596	AC5270	CE, CUL	615
AC3220	CE, CUL	596	AC5271	CE, CUL	615
AC3221	CE, CUL	596	AC528A	CE	615
AC326A	CE, (CCC)	317, 575	AC5292	CE, CUL	597
AC327A	CE	317, 622	AC535A		599
AC336A	CE	317, 622	AC542A	CE	615
AC5000	CUL	603	AC546A	CE	615
AC5003	CUL	603	AC551A	CE	615
AC5005	CUL	604	AC570A	CE	615

Order no.	Approvals	Catalogue page	Order no.	Approvals	Catalogue page
AC901S	CE, CUL	429, 629	CR1083	CE, E1R	704
AC902S	CE, CUL	429, 629	CR1084	CE, E1R	705
AC903S	CE, CUL	429, 629	CR1085	CE, E1R	705
AC904S	CE, CUL	430, 630	CR1087	CE, E1R	704
AL1000	CE, PI	594	CR1200	CE, E1R	705
AL1010	CE, PI	594	CR1201	CE, E1R	705
AL1020	CE	594	CR1500	CE	699
AL1030	CE	594	CR2011	CE	698
AL2400	CE	594	CR2012	CE, E1R	699
AL2401	CE	595	CR2013	CE	699
ANT410	CE, CUL	645	CR2014	CE, E1R	699
ANT411	CE, CUL	645	CR2016	CE, E1R	699
ANT430	CE, CUL	645	CR2031	CE, E1R	698
ANT431	CE, CUL	645	CR2032	CE, E1R	698
ANT512	CE, CUL	641	CR2033	CE, E1R	698
ANT513	CE, CUL	645	CR2500	CE, E1R	691
ANT805		651	CR2512	CE, E1R	699
ANT810		651	CR2513	CE	699
ANT815		651	CR2520	CE, E1R	699
ANT820		651	CR2530	CE, E1R	691
ANT830		651	CR2532	CE, E1R	691
ANT910		651	CR3001	CE	718
ANT930		651	CR3002	CE	718
AY1000	CE, CUL	595	CR3003	CE	718
AY1020	CE, CUL	595	CR3004	CE	718
CP9006		426, 688	CR3101	CE	714
CP9008		426, 688	CR3114	CE	714
CR0020	CE, E1R	690	CR7021	CE, E1R	426, 691
CR0032	CE, E1R	692	CR7032	CE, E1R	692
CR0033	CE, E1R	692	CR7132	CE, E1R	692
CR0133	CE, E1R	692	CR7201	CE, E1R	426, 691
CR0200	CE, E1R	691	CR7506	CE, E1R	426, 691
CR0234	CE, E1R	692	DA101S	CE, CUL	361, 423
CR0235	CE, E1R	692	DA102S	CE, CUL	361
CR0301	CE, E1R	693	DD0203	CE, CUL	359
CR0302	CE, E1R	693	DD0296	CE, CUL	359
CR0303	CE, E1R	693	DD110S	CE	361
CR0401	CE, E1R	684	DD111S	CE	361
CR0403	CE, CUL, E1R	684	DD2503	CE, CUL	358
CR0411	CE, E1R	684	DD2505	CE, CUL	358
CR0421	CE	685	DD2603	CE, CUL	358
CR0431	CE, E1R	684	DD2605	CE, CUL	358
CR0451	CE, E1R	679, 685	DI0001	CE	346
CR0452	CE, E1R	647, 685	DI0002	CE	346
CR0505	CE, E1R	690	DI0004	CE	346
CR1070	CE, E1R	704	DI003A	CE	347
CR1071	CE, E1R	704	DI004A	CE	347
CR1080	CE, E1R	705	DI5001	CE	346
CR1081	CE, E1R	705	DI5003	CE	346
CR1082	CE, E1R	705	DI5004	CE	346

Order no.	Approvals	Catalogue page	Order no.	Approvals	Catalogue page
DI5005	CE	346	DTM425	CE, CUL	646, 721
DI5007	CE	346	DTM434	CE, (CCC)	646
DI5009	CE	346	DTM435	CE, (CCC)	646
DI5011	CE	346	DU110S	CE	361
DI504A	CE	347	DW2503	CE, CUL	361
DI505A	CE	347	DX2001	CE	362
DI506A	CE	347	DX2002	CE	362
DI6001	CE, CUL	346	DX2003	CE	362
DI602A	CE	347	DX2011	CE	362
DL0201	CE, CUL	359	DX2012	CE	362
DL0203	CE, CUL	359	E10013		746
DL2503	CE, CUL	362	E10014		120
DN0210	CE	348, 832	E10015		121
DN0220	CE	832	E10016		120
DN1022	CE, CUL	833	E10017		120, 458
DN1030	CE, CRUUS, CUL	833	E10024		122
DN1031	CE, CRUUS, CUL	833	E10025		122
DN2035	CE, CUL	834	E10027		122
DN2036	CE, CUL	834	E10028		123
DN4011	CE, CRUUS, CUL	833	E10030		123
DN4012	CE, CRUUS, CUL	833	E10031		123
DN4013	CE, CRUUS, CUL	833	E10058		748
DN4014	CE, CRUUS, CUL	833	E10076		122, 162
DN4032	CE, CRUUS, CUL	833	E10077		123, 162
DN4033	CE, CRUUS, CUL	834	E10136		741
DN4034	CE, CRUUS, CUL	834	E10137		746
DR2503	CE, CUL	360	E10154		121
DR2505	CE, CUL	360	E10155		120
DS2503	CE, CUL	359	E10189		747
DS2505	CE, CUL	360	E10190		747
DS2506	CE, CUL	360	E10191		747
DS2603	CE, CUL	360	E10192		120
DS2605	CE, CUL	360	E10193		120, 458
DT0001	CE	363, 833	E10200		747
DTA100	CE, CUL	619, 638	E10204		120
DTA101	CE, CUL	619, 638	E10221		121, 176
DTA200	CE, CUL	619, 638	E10261		747
DTA201	CE, CUL	619, 639	E10437		806
DTA300	CE, CUL	619, 639	E10447		746
DTA301	CE, CUL	619, 639	E10448		746
DTE100	CE, CUL, PI	641, 644	E10579		320, 578
DTE101	CE, CUL, PI	640, 644	E10584		320, 578
DTE102	CE, CUL	641, 645	E10585		320, 578
DTE104	CE, CUL	641, 645	E10597		320, 579
DTE800	CE	650	E10661		318, 577
DTE810	CE	650	E10730		123, 640
DTE820		650	E10734		121, 176
DTE900	CUL	650	E10735		121, 162
DTE910	CUL	650	E10736		122, 162
DTM424	CE, (CCC)	646	E10737		123, 162

(CCC) = CCC approval is not required

Order no.	Approvals	Catalogue page	Order no.	Approvals	Catalogue page
E10741		121	E11416		785
E10742		122	E11417		785
E10743		123	E11418		785
E10749		175	E11419		785
E10750		175	E11420		785
E10751		175	E11421		785
E10752		175	E11422		785
E10753		176	E11423		785
E10754		176	E11424		785
E10802		605	E11425		785
E10803		605	E11426		786
E10806		121	E11427		786
E10807		122	E11428		786
E10808		123	E11429		786
E10848		121	E11430		786
E10849		121	E11431		785
E10865		740	E11432		785
E10866		740	E11433		785
E10867		740	E11434		786
E10868		741	E11435		786
E10880		162	E11436		786
E10886		747	E11437		786
E10887		747	E11438		786
E10976		742	E11439		786
E10977		742	E11440		786
E11027		161	E11504	CRUUS	702, 767
E11030		161	E11505	CRUUS	702, 767
E11032		161	E11506	CRUUS	701, 767
E11034		161	E11507	CRUUS	702, 767
E11036		161	E11508	CRUUS	741
E11037		162	E11509	CRUUS	741
E11043		749	E11510		741
E11047		121, 176	E11511	CRUUS	702, 716
E11048		122, 176	E11512	CRUUS	742
E11049		123, 237	E11521		121
E11078		162	E11530		120
E11114		122	E11531		120
E11115		122	E11533		121
E11226		745	E11534		122
E11227		745	E11550		766
E11231		380, 743	E11551		766
E11232		380, 743	E11552		739
E11243		321, 579	E11553		740
E11248		748	E11569		392
E11249	CRUUS	748	E11589		701, 731
E11250		748	E11590		701, 731
E11251		748	E11591		701, 731
E11278		319, 577	E11592		701, 731
E11310		320, 579	E11593		701, 731
E11311		380, 743	E11594		701, 731

Order no.	Approvals	Catalogue page	Order no.	Approvals	Catalogue page
E11596		701, 730	E11894		194
E11597		701, 731	E11895		194
E11598		701, 731	E11898		379, 642
E11599		701, 731	E11900		321, 579
E11645		745	E11912		193
E11697		745	E11913		193
E11736		746	E11914		195
E11737		746	E11928		195
E11738		746	E11930		423
E11739		746	E11950		380, 743
E11740		746	E11957		194
E11741		746	E11958		192
E11742		747	E11959		193
E11743		747	E11960		193
E11744		747	E11961		192
E11745		746	E11975		192
E11746		747	E11976		192
E11747		747	E11977		192
E11775		812	E11978		192
E11796		194	E11979		192
E11797		193	E11980		192
E11798		195	E11981		192
E11799		193	E11982		192
E11801		193	E11984		320, 579
E11803		176	E11988		194
E11807		380, 743	E11989		321, 579
E11816		191	E11994	CE	121
E11817		191	E11995	CE	122
E11818		191	E11996	CE	123
E11819		191	E12004		195
E11820		191	E12009		321, 579
E11821		191	E12010		321, 579
E11822		192	E12015		193
E11823		192	E12017		193
E11846		192	E12042		321, 579
E11847		605	E12043		321, 579
E11857		768	E12090		379, 642
E11858		768	E12123		321, 579
E11859		768	E12153		162
E11860		702, 768	E12163		162
E11861		755	E12164		194
E11862		754	E12166		743
E11863		755	E12167		743
E11864		752	E12168		743
E11865		752	E12169		743
E11872		194	E12170		321, 579
E11877		192	E12204		380, 642
E11890		194	E12205		380, 642
E11891		194	E12208		320, 578
E11892		194	E12209		320, 578

Order no.	Approvals	Catalogue page	Order no.	Approvals	Catalogue page
E12212		320, 578	E20054		292
E12215		701, 731	E20055		292
E12218		194	E20056		292
E12231		193	E20057		293
E12232		193	E20058		292
E12233		193	E20059		291
E12234		193	E20060		291
E12259		194	E20061		291
E12274		280	E20062		291
E12291		175	E20078		293
E12315		642, 647	E20102		294
E12317		642, 647	E20103		294
E12319		642, 647	E20104		294
E12321		642, 647	E20105		294
E12355		707	E20106		294
E12375		194	E20107		294
E12377		161	E20127		292
E12378		161	E20128		291
E12379		161	E20129		291
E12380		161	E20130		291
E12386		161	E20211		293
E12402		339	E20215		293
E12432		340	E20228		291
E17105		318, 577	E20230		292
E17118		319, 577	E20249		292
E17148		319, 577	E20353		294
E17205		319, 577	E20428		748
E17294		319, 577	E20430		748
E17295		320, 578	E20452		235
E17296		320, 578	E20453		235
E17320		319, 577	E20454		235
E17321		319, 577	E20489		293
E17322		319, 577	E20492		292
E17323		319, 577	E20493		292
E17324		319, 577	E20494		293
E17325		319, 577	E20495		293
E17326		319, 577	E20505		292
E17327		319, 578	E20506		292
E17328		319, 578	E20507		293
E17329		319, 578	E20590		236
E17330		320, 578	E20593		293
E17331		320, 578	E20600		294
E19503		122	E20603		287
E1D100		274, 279	E20606		287
E20003		235	E20609		287
E20004		235	E20612		287
E20005		235	E20615		287
E20051		292	E20633		288
E20052		292	E20639		288
E20053		292	E20645		288

Order no.	Approvals	Catalogue page	Order no.	Approvals	Catalogue page
E20648		288	E20856		124
E20651		288	E20857		124
E20654		288	E20860		124
E20679		293	E20861		124
E20680		293	E20864		124
E20689		287	E20865		124
E20711		288	E20866		124, 177
E20712		288	E20867		124, 177
E20714		287	E20869		124, 176
E20715		289	E20870		125, 177
E20716		243	E20873		125, 238
E20717		243	E20874		125, 238
E20718		124, 176	E20875		125, 238
E20719		124, 176	E20877		242
E20720		237, 272	E20901		640
E20721		237, 272	E20903		236
E20722		272, 307	E20907		236
E20724		236	E20911		236
E20737		272	E20914		236
E20738		742	E20915		236
E20744		235	E20938		238, 243
E20748		288	E20939		371, 375
E20749		289	E20940		243, 274
E20750		287	E20941		371, 658
E20751		287	E20946		371, 657
E20752		287	E20948		371, 657
E20753		287	E20950		244
E20754		293	E20951		238, 244
E20755		293	E20952		371
E20756		288	E20953		235
E20757		287	E20954		235
E20758		288	E20956		235
E20762		293	E20964		239, 307
E20765		289	E20965		239, 307
E20767		289	E20966		239, 308
E20772		289	E20968		239, 307
E20773		290	E20969		239, 308
E20774		290	E20970		240, 308
E20788		241	E20973		239, 308
E20789		241	E20974		239, 307
E20792		242	E20984		239, 307
E20793		242	E20988		272
E20794		273	E20989		271
E20796		243	E20990		271
E20811		124	E20991		271
E20813		123, 124	E20992		271
E20814		124	E20993		271
E20838		742	E20994		272
E20843		243	E21007		236
E20844		243	E21012		242

Order no.	Approvals	Catalogue page	Order no.	Approvals	Catalogue page
E21015		236	E21200		237
E21056		238	E21201		237
E21057		238	E21202		237
E21076		371, 658	E21203		237
E21079		274, 279	E21204		244, 274
E21081		243, 274	E21205		244
E21083		241, 273	E21206		237, 272
E21084		241, 273	E21207		237, 272
E21085		240, 272	E21208		244, 275
E21086		240, 273	E21209		244, 275
E21087		240, 272	E21210		241, 273
E21088		240, 242	E21211		241, 273
E21095		239, 308	E21212		241, 273
E21101		288	E21213		244, 309
E21102		288	E21214		244, 309
E21103		287	E21215	CUL	242
E21104		288	E21216		242
E21105		289	E21217		242
E21106		289	E21218		242
E21107		289	E21219		272
E21109		371, 657	E21220		272
E21110		243, 370	E21221		240, 308
E21111		371	E21222		239, 308
E21112		371, 657	E21223		241, 273
E21113		371, 657	E21224		274
E21114		241, 273	E21228		375, 379
E21115		235	E21229		375, 379
E21116		242	E21232		375, 379
E21117		242	E21236		274
E21118		243	E21237	CE	238
E21119		243	E21238	CE	239
E21120		242, 274	E21239	CE	239
E21122		240, 242	E21240	CE	239
E21125		244	E21248		280
E21126		244	E21267		235
E21133		274, 279	E21268		236
E21137		380, 711	E21269		236
E21138		379, 711	E21270		236
E21139		380, 711	E21271		240
E21140		380	E21272		240
E21142		241, 273	E21273		240
E21144		236	E21277		240
E21145		237	E21280		240
E21159		274, 279	E2D106		372
E21165		372, 658	E2D107		370
E21166		372, 658	E2D108		370
E21168		372, 658	E2D109		370
E21169		658	E2D110		370, 657
E21171		274, 279	E2D112		370, 657
E21172		372	E2D114		384, 657

Order no.	Approvals	Catalogue page	Order no.	Approvals	Catalogue page
E2D115		384	E30078		546
E2D116		384, 657	E30079		546
E2D200		370	E30080	CE	666
E2D201		384, 657	E30091		550
E2D202		384	E30094		458, 552
E2D400		370, 375	E30108		551
E2D401		370, 375	E30110		517
E2D402		370, 375	E30112		380, 666
E2I200		656	E30115		667
E2I210		656	E30116		460
E2I211		656	E30122	EC 19352004, EHEDG, FDA	463, 492
E2I212		656	E30123	EC 19352004, FDA	461
E2I213		656	E30124	EC 19352004, FDA	461
E2M200		710	E30128	EC 19352004, EHEDG, FDA	463, 554
E2M201		710	E30130	CRN, EC 19352004, EHEDG, FDA	463
E2M203		710	E30132		667
E2M205		710	E30135		461
E2M206		710	E30136		665
E2M210		711	E30137		665
E2M211		710	E30140		459
E2M212		710	E30141		459
E2M213		711	E30143		460
E2V100		370	E30144		551
E30000		460	E30390	CE	459, 518
E30003		460	E30393	EC 19352004, EHEDG, FDA	548
E30006		546	E30396	CE	160, 238
E30009		464	E30397		548
E30010		460	E30398	CE, CUL	160, 238
E30013	EC 19352004, EHEDG, FDA	463	E30399		459, 524
E30016		551	E30400		459, 524
E30017		550	E30401		459, 524
E30018		551	E30402		459, 524
E30024	CRN	551	E30403	EC 19352004, EHEDG, FDA	548
E30025		551	E30405	CE	458, 547
E30047		551	E30407	EC 19352004, EHEDG, FDA	551
E30049		551	E30420		458
E30050		460	E30421		458, 546
E30055	EC 19352004, EHEDG, FDA	518, 555	E33201	CRN, EC 19352004, EHEDG, FDA	461, 491
E30056	EC 19352004, EHEDG, FDA	518, 555	E33202	CRN, EC 19352004, EHEDG, FDA	461, 491
E30057		461	E33208	CRN, EC 19352004, EHEDG, FDA	461
E30058	CRN	460	E33209	CRN, EC 19352004, EHEDG, FDA	461
E30059		460	E33211	EC 19352004, EHEDG, FDA	462, 491
E30063		460	E33212	EC 19352004, EHEDG, FDA	462, 491
E30065		460	E33213	EC 19352004, EHEDG, FDA	462, 491
E30070		463	E33221	EC 19352004, EHEDG, FDA	461, 492
E30071		464	E33222	EC 19352004, EHEDG, FDA	462, 492
E30072	EC 19352004, FDA	463	E33228	EC 19352004, EHEDG, FDA	461
E30073		551	E33229	EC 19352004, EHEDG, FDA	462
E30076		459	E33242	EC 19352004, FDA	463, 492
E30077		459	E33340	EC 19352004, FDA	463

Order no.	Approvals	Catalogue page	Order no.	Approvals	Catalogue page
E33401	EC 19352004, EHEDG, FDA	518, 554	E37643		549
E33402	EC 19352004, EHEDG, FDA	518, 554	E37663		550
E33430	EC 19352004, EHEDG, FDA	519, 554	E37810	EC 19352004, EHEDG, FDA	549
E33431		551	E37820	EC 19352004, EHEDG, FDA	549
E33601	EC 19352004, EHEDG, FDA	463	E37830	EC 19352004, EHEDG, FDA	549
E33612	EC 19352004, EHEDG, FDA	463	E37850	EC 19352004, EHEDG, FDA	549
E33701	EC 19352004, EHEDG, FDA	461, 491	E37910	EC 19352004, EHEDG, FDA	549
E33702	EC 19352004, EHEDG, FDA	461, 491	E37920	EC 19352004, EHEDG, FDA	549
E33711	EC 19352004, EHEDG, FDA	462, 491	E37930	EC 19352004, EHEDG, FDA	549
E33712	EC 19352004, EHEDG, FDA	462, 491	E37950	EC 19352004, EHEDG, FDA	549
E33713	EC 19352004, EHEDG, FDA	462, 491	E3D103		375, 379
E33721	EC 19352004, EHEDG, FDA	462, 492	E3D200		375
E33722	EC 19352004, EHEDG, FDA	462, 492	E3D201		379
E33731	EC 19352004, EHEDG, FDA	462, 492	E3D300		375, 379
E33732	EC 19352004, EHEDG, FDA	462, 492	E3D301		375, 379
E35010		548	E3M100		709
E35020		548	E3M103		709
E35030		548	E3M121		709
E35050		548	E3M122		709
E35060		546	E3M123		709
E35061		546	E3M131		709
E35062		546	E3M132		709
E35063		547	E3M133		709
E35065		547	E40048		492
E35066		547	E40078		489
E35067		547	E40079		489
E35068		547	E40083		489
E37210		548	E40096		490, 552
E37211		548	E40097		490, 552
E37220		549	E40098		490, 552
E37221		549	E40099	CRN	490, 552
E37230		549	E40100		490, 552
E37250		549	E40101		490, 552
E37340		459	E40104		490, 552
E37350		460	E40106		490
E37360		460	E40107	CRN	552
E37411	EC 19352004, FDA	550	E40114		490, 551
E37421	EC 19352004, FDA	550	E40115		490
E37430	EC 19352004, FDA	550	E40124		490, 551
E37431	EC 19352004, FDA	550	E40128		552
E37450	EC 19352004, FDA	550	E40129		490
E37511	EC 19352004, EHEDG, FDA	550	E40136		489
E37521	EC 19352004, EHEDG, FDA	550	E40138		490
E37600		550	E40148		551
E37603		549	E40151		493, 674
E37610		550	E40153		493, 674
E37613		549	E40161		489
E37620		550	E40162		490
E37623		549	E40171		491, 567
E37640		550	E40178		492, 673

Order no.	Approvals	Catalogue page	Order no.	Approvals	Catalogue page
E40179		493, 673	E43211		522
E40180		493, 673	E43212		522
E40189		492, 673	E43213		522
E40195	CRN	490	E43214		522
E40199		492, 673	E43215		522
E40203		491	E43216		522
E40205		493, 674	E43217		522
E40213		493, 674	E43218		522
E40214		493, 674	E43219		522
E40215		493, 674	E43220		523
E40216		493, 674	E43221		523
E40217		493, 674	E43223		523
E40227		493, 674	E43224		523
E40228		493, 674	E43225		520
E40229		493, 674	E43226		520
E40230		493, 674	E43227		520
E40231		493, 674	E43228		522
E40234		494, 675	E43229		522
E40240		494, 675	E43230		522
E40249		491	E43300	EC19352004, EHEDG, FDA	518, 554
E40250		494	E43301	EC19352004, EHEDG, FDA	518, 554
E40251		494	E43302	EC19352004, EHEDG, FDA	518
E43000		517	E43303	CRN, EC19352004, EHEDG, FDA	519
E43001		516	E43304	EC19352004, EHEDG, FDA	519, 554
E43002		517	E43305	EC19352004, EHEDG, FDA	519, 554
E43003		516	E43306	EC19352004, EHEDG, FDA	519, 555
E43004		517	E43307	EC19352004, EHEDG, FDA	519, 555
E43006		516	E43308	EC19352004, EHEDG	519, 555
E43007		516	E43309	CRN, EC19352004, EHEDG, FDA	519, 555
E43008		516	E43310	EC19352004, EHEDG, FDA	519, 555
E43009		517	E43311	EC19352004, EHEDG, FDA	519, 555
E43012		516	E43312	EC19352004, EHEDG, FDA	520, 555
E43013		517	E43313	EC19352004	519
E43014		516	E43314		519, 555
E43016		517	E43315	EC19352004, EHEDG, FDA	519, 556
E43019		516	E43319	EC19352004, FDA	556
E43100		517	E43330		679
E43101		517	E43331		679
E43102		517	E43332		679
E43103		517	E43333		523
E43201		520	E43334		523
E43202		520	E43340	EC19352004, FDA	521
E43203		520	E43341	EC19352004, FDA	521
E43204		520	E43342	EC19352004, FDA	521
E43205		520	E43345	EC19352004, FDA	521
E43206		520	E43346	EC19352004, FDA	521
E43207		521	E43347	EC19352004, FDA	521
E43208		521	E43348	EC19352004, FDA	521
E43209		521	E43351		520
E43210		521	E43352		520

Order no.	Approvals	Catalogue page	Order no.	Approvals	Catalogue page
E43353		521	E70075	CE	429, 629
E43354		522	E70096		604
E43355		522	E70113		607
E43356		522	E70142		748
E43400		679	E70188		604
E43900		161	E70200		604
E43902		161	E70211		606
E43904		161	E70213		606
E43910		517	E70230		604
E43911		551	E70231		604
E60006		339	E70232		604
E60022		338	E70233		604
E60027		338	E70236		604
E60028		338	E70271		604
E60033		337	E70297		605
E60034		337	E70299		607
E60035		337	E70320		606
E60036		337	E70354	CUL	603
E60041		337	E70377	CUL	603
E60062		338	E70381		604
E60063		338	E70390		607
E60064		338	E70399		607
E60065		338	E70405		430, 630
E60066		338	E70413		607
E60067		338	E70423		606
E60076		339	E70424		700
E60095		339	E70454	CUL	603
E60098		339	E70481		605
E60110		339	E70483		605
E60111		339	E70498		605
E60112		339	E70499		605
E60117		338	E70505		430, 630
E60118		338	E70515		430, 630
E60119		338	E70525		430, 630
E60120		338	E70535	CE, CUL	430, 630
E60121		338	E73004		605
E60137		339	E73005		605
E60138		339	E7354A	CE	604
E60193		338	E7377A	CE	604
E60302		337	E74000		606
E60303		348	E74010		606
E7000A		606	E74100		606
E7001S		430, 630	E74110		606
E7002S		430, 630	E74200	CRUUS, CSA	606
E7003S		430, 630	E74210	CRUUS, CSA	606
E7004S		430, 630	E74300	CSA, CRUUS	607
E7005S		430, 630	E74310	CSA, CRUUS	607
E70062		607	E75222		605
E70067		607	E75227		616
E7006S	CE	430, 630	E75228		616

Order no.	Approvals	Catalogue page	Order no.	Approvals	Catalogue page
E75229		616	E80382		646
E75231		616	E89005	CE	362
E75232		616	E89010		348, 364
E7901S		630	E89013		348, 364
E7902S		631	E89150	CE	363
E7903S		631	EBC001	CUL	809
E7904S		631	EBC002	CUL	809
E7905S		631	EBC003	CUL	811
E7906S		631	EBC004	CUL	811
E79995		605	EBC005	CUL	809
E79998		605	EBC006	CUL	809
E80100	CE	363	EBC007	CUL	811
E80102	CE	363	EBC008	CUL	811
E80110	CE	363	EBC009	CUL	809
E80301		639	EBC010	CUL	809
E80302		639	EBC011	CUL	811
E80304		640	EBC012	CUL	811
E80310		243, 274	EBC013	CUL	808
E80311		639	EBC014	CUL	810
E80312		639	EBC015	CUL	808
E80317		639	EBC016	CUL	810
E80318		639	EBC017	CUL	808
E80319		639	EBC018	CUL	810
E80320		639	EBC019	CUL	808
E80321	CE	640	EBC020	CUL	810
E80322		639	EBC021	CUL	809
E80323	CE	640	EBC022	CUL	810
E80324	CE	640	EBC023	CUL	809
E80330		652	EBC024	CUL	810
E80331		652	EBC025	CUL	808
E80332		652	EBC026	CUL	810
E80333		652	EBC027	CUL	808
E80340		652	EBC028	CUL	810
E80350		651	EBC029	CUL	808
E80351		651	EBC030	CUL	810
E80353		651	EBC031	CUL	808
E80354		651	EBC032	CUL	810
E80360		641	EBC033	CUL	809
E80361		641	EBC034	CUL	810
E80370		646	EBC035	CUL	809
E80371		646	EBC036	CUL	810
E80372		160	EBC048	CUL	806
E80373		160	EBC049		806
E80374		160	EBC050	CUL	806
E80375		160	EBC051	CUL	806
E80376		161	EBC052		806
E80377		646	EBC053	CUL	807
E80379		646	EBC054	CUL	807
E80380		646	EBC055	CUL	807
E80381		646	EBC056	CUL	807

Order no.	Approvals	Catalogue page	Order no.	Approvals	Catalogue page
EBC057		807	EC1411		706
EBC058	CUL	807	EC1412		706
EBC059		807	EC1413		706
EBC060	CUL	807	EC1414		706
EBC061	CUL	807	EC1450		706
EBC062		807	EC1452		705
EBC063	CUL	807	EC1453		705
EBC064	CUL	808	EC1520		694, 700
EBC065	CUL	808	EC1521		694, 700
EBC066	CUL	808	EC1522		694, 700
EBC067		808	EC1523		694, 700
EBC113	CE	811	EC1524		694, 701
EBC114	CE	811	EC1533		694, 701
EBC115	CE	811	EC2013		426, 693
EBC116	CE	811	EC2015	CE	694, 702
EBC117	CE	812	EC2016	CE	694, 702
EBC118	CE	812	EC2019	CE	354, 721
EC0400	CE, E1R	685	EC2025		718
EC0401		685	EC2032		695
EC0402		685	EC2034		715
EC0403		686	EC2045	CE	354, 721
EC0404		686	EC2046		427, 693
EC0405		686	EC2049		718
EC0406		686	EC2050		715
EC0407		686	EC2053		694, 700
EC0408		686	EC2056		702
EC0409		686	EC2058		716
EC0410		686	EC2059		706
EC0451		686	EC2060	CE	354, 721
EC0452		686	EC2061	CE	354, 722
EC0453		686	EC2062		702, 715
EC0454		686	EC2063		695, 716
EC0455		686	EC2074		693
EC0456		687	EC2075		694
EC0457		687	EC2076		694
EC0458		686	EC2080		380, 667
EC0459		687	EC2082	CE	354, 721
EC0460		687	EC2084		427, 693
EC0461		687	EC2086		427, 693
EC0462		687	EC2088		702
EC0463		687	EC2089		694, 700
EC0464		687	EC2090		694, 700
EC0465		687	EC2091		694
EC0466		687	EC2092		715
EC0467		687	EC2093		715
EC0468		687	EC2095	CE, E1	711
EC0469		687	EC2096		694
EC0470		687	EC2097		427, 693
EC1021		715	EC2098		700
EC1410		705	EC2099		707

Order no.	Approvals	Catalogue page	Order no.	Approvals	Catalogue page
EC2110		706	EVC030	CE, CUL	783
EC2112	CE	687, 709	EVC031	CE, CUL	783
EC2113		688, 715	EVC032	CE, CUL	783
EC2114		688, 709	EVC033	CE, CUL	783
EC2115		706	EVC034	CE, CUL	783
EC2116		715	EVC035	CUL	783
EC2117		706	EVC036	CUL	783
ENC01A	IEC	756	EVC037	CUL	783
ENC02A	IEC	756	EVC038	CUL	783
ENC03A	IEC	756	EVC039	CUL	647, 783
ENC04A	IEC	756	EVC040	CE, CUL	781
ENC05A	IEC	756	EVC041	CE, CUL	781
ENC06A	IEC	756	EVC042	CE, CUL	781
ENC07A	IEC	757	EVC043	CE, CUL	781
ENC08A	IEC	757	EVC044	CE, CUL	781
ENC09A	IEC	757	EVC045	CE, CUL	780
ENC10A	IEC	756	EVC046	CE, CUL	781
ENC11A	IEC	756	EVC047	CE, CUL	781
ENC12A	IEC	756	EVC048	CE, CUL	781
ENC13A	IEC	757	EVC049	CE, CUL	781
ENC14A	IEC	757	EVC04A	CE, IEC	756
EVC001	CE, CUL	729, 741	EVC050	CUL	781
EVC002	CE, CUL	729, 741	EVC051	CUL	781
EVC003	CE, CUL	729, 741	EVC052	CUL	781
EVC004	CE, CUL	729, 741	EVC053	CUL	781
EVC005	CE, CUL	729, 741	EVC054	CUL	781
EVC006	CE, CUL	729, 741	EVC055	CE, CUL	784
EVC007	CUL	741	EVC056	CE, CUL	784
EVC008	CUL	741	EVC057	CE, CUL	784
EVC009	CUL	742	EVC058	CE, CUL	784
EVC010	CE, CUL	728, 782	EVC059	CE, CUL	784
EVC011	CE, CUL	782	EVC05A	CE, IEC	756
EVC012	CE, CUL	729, 782	EVC060	CE, CUL	784
EVC013	CE, CUL	782	EVC061	CE, CUL	784
EVC014	CE, CUL	782	EVC062	CE, CUL	784
EVC015	CE, CUL	782	EVC063	CE, CUL	784
EVC016	CE, CUL	782	EVC064	CE, CUL	784
EVC017	CE, CUL	782	EVC065	CE, CUL	784
EVC018	CE, CUL	782	EVC066	CE, CUL	784
EVC019	CE, CUL	782	EVC067	CE, CUL	784
EVC020	CUL	782	EVC068	CE, CUL	784
EVC021	CUL	782	EVC069	CE, CUL	647, 784
EVC022	CUL	782	EVC06A	CE, IEC	756
EVC023	CUL	782	EVC070	CE, CUL	742
EVC024	CUL	782	EVC071	CE, CUL	742
EVC025	CE, CUL	783	EVC072	CE, CUL	742
EVC026	CE, CUL	783	EVC073	CE, CUL	742
EVC027	CE, CUL	783	EVC074	CE, CUL	742
EVC028	CE, CUL	783	EVC075	CE, CUL	742
EVC029	CE, CUL	783	EVC076	CE, CUL	767

Order no.	Approvals	Catalogue page	Order no.	Approvals	Catalogue page
EVC077	CE, CUL	767	EVC225	CUL	776
EVC078	CE, CUL	767	EVC226	CUL	776
EVC079	CE, CUL	766	EVC227	CUL	776
EVC07A	CE, IEC	798	EVC228	CUL	776
EVC080	CE, CUL	766	EVC229	CUL	777
EVC081	CE, CUL	767	EVC230	CUL	776
EVC094	CE, CUL	767	EVC231	CUL	776
EVC095	CE, CUL	767	EVC232	CUL	776
EVC09A	CE, IEC	798	EVC233	CUL	776
EVC10A	CE, IEC	798	EVC234	CUL	776
EVC11A	CE, IEC	798	EVC235	CUL	777
EVC12A	CE, IEC	798	EVC236	CUL	777
EVC13A	CE, IEC	798	EVC237	CUL	777
EVC141	CUL	738	EVC238	CUL	778
EVC142	CUL	739	EVC239	CUL	778
EVC143	CUL	739	EVC240	CUL	778
EVC144	CUL	739	EVC241	CUL	778
EVC145	CUL	739	EVC242	CUL	778
EVC146	CUL	739	EVC243	CUL	778
EVC147	CUL	739	EVC244	CUL	778
EVC148	CUL	739	EVC245	CUL	778
EVC149	CUL	739	EVC246	CUL	778
EVC14A	CE, CUL	756	EVC247	CUL	778
EVC150	CUL	739	EVC248	CUL	778
EVC151	CUL	739	EVC249	CUL	778
EVC152	CUL	739	EVC250	CUL	779
EVC153	CUL	739	EVC251	CUL	779
EVC154	CUL	740	EVC252	CUL	779
EVC155	CUL	740	EVC253	CUL	779
EVC161	CE, CUL	740	EVC254	CUL	779
EVC162	CE, CUL	740	EVC255	CUL	779
EVC163	CE, CUL	740	EVC256	CUL	779
EVC164	CE, CUL	740	EVC257	CUL	779
EVC165	CE, CUL	740	EVC258	CUL	779
EVC166	CE, CUL	740	EVC259	CUL	779
EVC210	CUL	777	EVC260	CUL	774
EVC211	CUL	777	EVC261	CUL	774
EVC212	CUL	777	EVC262	CUL	774
EVC213	CUL	777	EVC263	CUL	774
EVC214	CUL	777	EVC264	CUL	774
EVC215	CUL	776	EVC265	CUL	773
EVC216	CUL	776	EVC266	CUL	773
EVC217	CUL	776	EVC267	CUL	773
EVC218	CUL	776	EVC268	CUL	773
EVC219	CUL	776	EVC269	CUL	773
EVC220	CUL	777	EVC270	CUL	774
EVC221	CUL	777	EVC271	CUL	774
EVC222	CUL	777	EVC272	CUL	774
EVC223	CUL	777	EVC273	CUL	775
EVC224	CUL	777	EVC274	CUL	775

Order no.	Approvals	Catalogue page	Order no.	Approvals	Catalogue page
EVC275	CUL	772	EVC436	CE, CUL	826
EVC276	CUL	772	EVC437	CUL	826
EVC277	CUL	772	EVC438	CUL	827
EVC278	CUL	772	EVC439	CUL	827
EVC279	CUL	773	EVC492		339, 647
EVC280	CUL	773	EVC526	CUL	729, 743
EVC281	CUL	773	EVC527	CUL	729, 743
EVC282	CUL	773	EVC528	CUL	729, 743
EVC283	CUL	773	EVC529	CUL	729, 744
EVC284	CUL	773	EVC530	CUL	729, 744
EVC285	CUL	779	EVC531	CUL	729, 744
EVC286	CUL	779	EVC532	CUL	729, 744
EVC287	CUL	779	EVC533	CUL	729, 744
EVC288	CUL	779	EVC534	CUL	729, 744
EVC289	CUL	780	EVC535	CUL	730, 744
EVC290	CUL	780	EVC536	CUL	730, 744
EVC291	CUL	780	EVC537	CUL	730, 744
EVC292	CUL	780	EVC538	CUL	730, 744
EVC293	CUL	780	EVC539	CUL	730, 744
EVC294	CUL	780	EVC540	CUL	730, 744
EVC295	CUL	780	EVC541	CUL	730, 744
EVC296	CUL	780	EVC542	CUL	730, 744
EVC297	CUL	780	EVC543	CUL	730, 745
EVC298	CUL	780	EVC544	CUL	730, 745
EVC299	CUL	780	EVC545	CUL	730, 745
EVC300	CUL	775	EVC546	CUL	730, 745
EVC301	CUL	775	EVC547	CUL	730, 745
EVC302	CUL	775	EVC548	CUL	730, 745
EVC303	CUL	775	EVC549	CUL	730, 745
EVC304	CUL	775	EVM001	CE, CUL	757
EVC305	CUL	773	EVM002	CE, CUL	757
EVC306	CUL	773	EVM003	CE, CUL	757
EVC307	CUL	773	EVM004	CE, CUL	757
EVC308	CUL	774	EVM005	CE, CUL	757
EVC309	CUL	774	EVM006	CE, CUL	757
EVC310	CUL	775	EVM007	CUL	758
EVC311	CUL	775	EVM008	CUL	758
EVC312	CUL	775	EVM009	CUL	758
EVC313	CUL	775	EVM010	CE, CUL	757
EVC314	CUL	775	EVM012	CE, CUL	757
EVC315	CUL	774	EVM014	CE, CUL	758
EVC316	CUL	774	EVM036	CE, CUL	339, 647
EVC317	CUL	774	EVM037	CE, CUL	758
EVC318	CUL	774	EVM038	CE, CUL	647, 758
EVC319	CUL	774	EVM039	CE, CUL	339, 758
EVC431	CE, CUL	826	EVM040	CE, CUL	758
EVC432	CE, CUL	826	EVM041	CE, CUL	758
EVC433	CE, CUL	826	EVT001	CE, CUL	754
EVC434	CE, CUL	826	EVT002	CE, CUL	754
EVC435	CE, CUL	826	EVT003	CE, CUL	754

Order no.	Approvals	Catalogue page	Order no.	Approvals	Catalogue page
EVT004	CE, CUL	754	EVT060	CE, CUL	798
EVT005	CE, CUL	754	EVT061	CE, CUL	798
EVT006	CE, CUL	754	EVT062	CE, CUL	798
EVT007	CUL	755	EVT063	CE, CUL	798
EVT008	CUL	755	EVT064	CE, CUL	754
EVT009	CUL	755	EVT067	CE, CUL	754
EVT010	CE, CUL	755	EVT069	CUL	755
EVT011	CE, CUL	755	EVT071	CE, CUL	767
EVT012	CE, CUL	755	EVT072	CE, CUL	768
EVT013	CE, CUL	755	EVT073	CE, CUL	768
EVT014	CE, CUL	755	EVT074	CE, CUL	768
EVT015	CE, CUL	755	EVT122	CUL	752
EVT022	CE, CUL	795	EVT123	CUL	753
EVT023	CE, CUL	795	EVT124	CUL	753
EVT024	CE, CUL	795	EVT125	CUL	753
EVT025	CE, CUL	795	EVT126	CUL	753
EVT026	CE, CUL	795	EVT127	CUL	753
EVT027	CE, CUL	795	EVT128	CUL	753
EVT028	CE, CUL	794	EVT129	CUL	753
EVT029	CE, CUL	795	EVT130	CUL	753
EVT030	CE, CUL	795	EVT131	CUL	753
EVT031	CE, CUL	795	EVT132	CUL	753
EVT032	CE, CUL	795	EVT133	CUL	753
EVT033	CE, CUL	795	EVT134	CUL	753
EVT034	CUL	795	EVT135	CUL	753
EVT035	CUL	795	EVT136	CUL	753
EVT036	CUL	795	EVT137	CUL	754
EVT037	CUL	795	EVT138	CUL	754
EVT038	CUL	796	EVT139	CUL	754
EVT039	CUL	796	EVT140	CUL	754
EVT040	CE, CUL	797	EVT141	CUL	754
EVT041	CE, CUL	797	EVT142	CUL	788
EVT042	CE, CUL	797	EVT143	CUL	788
EVT043	CE, CUL	797	EVT144	CUL	788
EVT044	CE, CUL	797	EVT145	CUL	788
EVT045	CE, CUL	797	EVT146	CUL	788
EVT046	CE, CUL	796	EVT147	CUL	789
EVT047	CE, CUL	796	EVT148	CUL	789
EVT048	CE, CUL	796	EVT149	CUL	789
EVT049	CE, CUL	797	EVT150	CUL	789
EVT050	CE, CUL	797	EVT151	CUL	789
EVT051	CE, CUL	797	EVT152	CUL	789
EVT052	CUL	797	EVT153	CUL	789
EVT053	CUL	797	EVT154	CUL	789
EVT054	CUL	797	EVT155	CUL	789
EVT055	CUL	797	EVT156	CUL	789
EVT056	CUL	797	EVT157	CUL	789
EVT057	CUL	797	EVT158	CUL	789
EVT058	CE, CUL	798	EVT159	CUL	789
EVT059	CE, CUL	798	EVT160	CUL	789

Order no.	Approvals	Catalogue page	Order no.	Approvals	Catalogue page
EVT161	CUL	790	EVT243	CUL	794
EVT162	CUL	790	EVT244	CUL	794
EVT163	CUL	790	EVT245	CUL	794
EVT164	CUL	790	EVT246	CUL	794
EVT165	CUL	790	EVT248	CUL	796
EVT166	CUL	790	EVT249	CUL	796
EVT167	CUL	790	EVT250	CUL	796
EVT168	CUL	790	EVT251	CUL	796
EVT169	CUL	790	EVT253	CUL	796
EVT170	CUL	790	EVT254	CUL	796
EVT171	CUL	790	EVT255	CUL	796
EVT172	CUL	790	EVT256	CUL	796
EVT173	CUL	790	EVT257	CUL	796
EVT174	CUL	790	EVT260	CUL	791
EVT175	CUL	790	EVT261	CUL	791
EVT176	CUL	791	EVT262	CUL	792
EVT177	CUL	791	EVT263	CUL	792
EVT178	CUL	792	EVT265	CUL	792
EVT179	CUL	792	EVT266	CUL	792
EVT180	CUL	792	EVT267	CUL	792
EVT181	CUL	792	EVT268	CUL	792
EVT182	CUL	792	EVT269	CUL	792
EVT183	CUL	792	EVT279	CUL	791
EVT184	CUL	792	EVT280	CUL	791
EVT185	CUL	792	EVT281	CUL	791
EVT186	CUL	793	EVT283	CUL	791
EVT187	CUL	793	EVT284	CUL	791
EVT188	CUL	793	EVT285	CUL	791
EVT189	CUL	793	EVT286	CUL	791
EVT190	CUL	793	EVT329	CE, CUL	827
EVT191	CUL	793	EVT330	CE, CUL	827
EVT192	CUL	793	EVT331	CE, CUL	827
EVT193	CUL	793	EVT332	CE, CUL	827
EVT194	CUL	793	EVT333	CE, CUL	827
EVT195	CUL	793	EVT334	CE, CUL	827
EVT196	CUL	793	EVT335	CUL	827
EVT197	CUL	793	EVT336	CUL	827
EVT198	CUL	793	EVT337	CUL	827
EVT199	CUL	793	EVT381	CUL	750
EVT200	CUL	793	EVT382	CUL	750
EVT201	CUL	794	EVT383	CUL	750
EVT203	CUL	791	EVT384	CUL	750
EVT204	CUL	791	EVT385	CUL	750
EVT211	CUL	791	EVT386	CUL	750
EVT236	CUL	794	EVT387	CUL	750
EVT237	CUL	794	EVT388	CUL	750
EVT238	CUL	794	EVT389	CUL	751
EVT239	CUL	794	EVT390	CUL	751
EVT240	CUL	794	EVT391	CUL	751
EVT242	CUL	794	EVT392	CUL	751

Order no.	Approvals	Catalogue page	Order no.	Approvals	Catalogue page
EVT393	CUL	751	EVW053	CE, CUL	788
EVT394	CUL	751	EVW054	CE, CUL	787
EVT395	CUL	751	EVW055	CE, CUL	787
EVT396	CUL	751	EVW056	CE, CUL	787
EVT397	CUL	751	EVW057	CE, CUL	787
EVT398	CUL	751	EVW058	CE, CUL	788
EVT399	CUL	751	EVW059	CE, CUL	788
EVT400	CUL	751	EY1001	CE	408
EVT401	CUL	751	EY1002	CE	408
EVT402	CUL	751	EY1003	CE	408
EVT403	CUL	751	EY1004	CE	408, 417
EVT404	CUL	752	EY1005	CE	408
EVT405	CUL	752	EY1006	CE	408, 417
EVT406	CUL	752	EY1007	CE	408, 417
EVT407	CUL	752	EY1008	CE	408
EVT408	CUL	752	EY1009	CE	408
EVT409	CUL	752	EY1010	CE	408
EVT410	CUL	752	EY1011	CE	410, 418
EVT411	CUL	752	EY1013	CE	410, 418
EVT412	CUL	752	EY1014	CE	410
EVW001	CE, CUL	749	EY1015	CE	410
EVW002	CE, CUL	749	EY2001	CE	409, 418
EVW003	CE, CUL	749	EY2002	CE	410, 418
EVW004	CE, CUL	749	EY2003	CE	410
EVW005	CE, CUL	749	EY2004	CE	410
EVW006	CE, CUL	749	EY2005	CE	410, 418
EVW007	CUL	749	EY3001	CE	408, 417
EVW008	CUL	749	EY3002	CE	408, 417
EVW009	CUL	749	EY3004	CE	409, 417
EVW010	CE, CUL	750	EY3005	CE	409, 417
EVW011	CE, CUL	750	EY3006		409
EVW012	CE, CUL	750	EY3007		409
EVW013	CE, CUL	749	EY3008		409
EVW014	CE, CUL	749	EY3009		409
EVW015	CE, CUL	750	EY3010		409
EVW022	CE, CUL	787	EY3011		409, 417
EVW023	CE, CUL	787	EY3090		409, 417
EVW024	CE, CUL	787	EY3091		409, 417
EVW025	CE, CUL	787	EY3092		409, 417
EVW028	CE, CUL	787	EY3098	CE	409, 417
EVW030	CE, CUL	787	EY3099	CE	409, 417
EVW031	CE, CUL	787	G1501S	CE, CUL, TÜV Nord	422
EVW034	CE, CUL	787	G1502S	CE, CUL, TÜV Nord	422
EVW036	CE, CUL	787	G1503S	CE, CUL, TÜV Nord	422
EVW037	CE, CUL	787	G2001S	CE	423
EVW048	CE, CUL	788	GF711S	CE, CUL, TÜV Nord	391
EVW049	CE, CUL	788	GG505S	CE, CUL, TÜV Nord	390, 429
EVW050	CE, CUL	788	GG507S	CE, CUL, TÜV Nord	390
EVW051	CE, CUL	788	GG711S	CE, CUL, TÜV Nord	391
EVW052	CE, CUL	788	GG712S	CE, CUL, TÜV Nord	391

Order no.	Approvals	Catalogue page	Order no.	Approvals	Catalogue page
GG851S	CE, CUL	391	IA5108	CCC, CE	77
GI505S	CE, CUL, TÜV Nord	390, 429	IA5122	CCC, CE, CUL	78
GI506S	CE, CUL, TÜV Nord	390	IA5127	CE, CUL, (CCC)	77
GI701S	CE, CUL, TÜV Nord	391	IB0004	CCC, CE	83
GI711S	CE, CUL, TÜV Nord	391	IB0016	CCC, CE, CUL	85
GI712S	CE, CUL, TÜV Nord	391	IB0017	CE, CCC	84
GM504S	CE, CUL, TÜV Nord	390, 429	IB0026	CCC, CE	83
GM505S	CE, CUL, TÜV Nord	390, 429	IB0027	CE, CCC	84
GM701S	CE, CUL, TÜV Nord	391	IB5063	CE, CUL, (CCC)	78
GM705S	CE, CUL, TÜV Nord	391	IB5096	CE, (CCC)	76
I12001	CE	69	IB5124	CCC, CE, CUL	78
I12003	CE	69	IB5133	CE, (CCC)	78
I17001	CE, (CCC)	70	IC0003	CCC, CE, CUL	84
I17003	CE, (CCC)	70	IC5005	CE, CUL, (CCC)	82
I22001	CE	69	ID0013	CCC, CE, CUL	85
I22003	CE	69	ID0014	CE, CCC	83
I22006	CE	70	ID002A	CE	118
I27001	CE, (CCC)	70	ID0049	CCC, CE	84
I7R201	CE, CUL, (CCC)	88	ID5005	CE, CUL, (CCC)	82
I7R202	CE, CUL, (CCC)	87	ID5026	CE, (CCC)	78
I7R203	CE, CUL, (CCC)	88	ID502A	CE	118
I7R204	CE, CUL, (CCC)	87	ID503A	CE, IEC	119
I7R205	CE, CUL, (CCC)	88	ID5046	CE, CUL, (CCC)	80
I7R206	CE, CUL, (CCC)	87	ID5055	CE, CUL, (CCC)	79
I7R207	CE, CUL, (CCC)	88	ID5058	CE, (CCC)	80
I7R208	CE, CUL, (CCC)	87	ID5059	CE, CUL, (CCC)	104
I7R209	CE, CUL, (CCC)	88	IE5072	CE, (CCC)	71
I7R210	CE, CUL, (CCC)	87	IE5090	CE, CUL, (CCC)	74
I7R211	CE, CUL, (CCC)	88	IE5099	CE, (CCC)	71
I7R212	CE, CUL, (CCC)	87	IE5121	CE, (CCC)	71
I7R213	CE, CUL, (CCC)	88	IE5129	CE, (CCC)	71
I7R214	CE, CUL, (CCC)	88	IE5202	CE, (CCC)	72
I7R215	CE, CUL, (CCC)	88	IE5203	CE, CUL, (CCC)	74
I7R216	CE, CUL, (CCC)	88	IE5215	CE, (CCC)	112
I7R217	CE, CUL, (CCC)	88	IE5222	CE, (CCC)	72
I85000	CE, CUL, (CCC)	89	IE5238	CE, (CCC)	73
I85001	CE, CUL, (CCC)	89	IE5258	CE, CUL, (CCC)	76
I85002	CE, CUL, (CCC)	89	IE5287	CE, CUL, (CCC)	75
I85003	CE, CUL, (CCC)	88	IE5288	CE, CUL, (CCC)	74
I85004	CE, CUL, (CCC)	89	IE5295	CE, (CCC)	112
I85005	CE, CUL, (CCC)	89	IE5312	CE, (CCC)	74
I85006	CE, CUL, (CCC)	89	IE5327	CE, CUL, (CCC)	74
I85007	CE, CUL, (CCC)	88	IE5338	CE, CUL, (CCC)	75
I95045	CE	87	IE5340	CE, CUL, (CCC)	75
IA0004	CCC, CE	83	IE5343	CE, CUL, (CCC)	70
IA0027	CCC, CE	84	IE5344	CE, CUL, (CCC)	70
IA0032	CCC, CE, CUL	85	IE5345	CE, CUL, (CCC)	70
IA5062	CE, CUL, (CCC)	77	IE5346	CE, CUL, (CCC)	70
IA5063	CE, CUL, (CCC)	77	IE5348	CE, CUL, (CCC)	71
IA5082	CE, (CCC)	76	IE5349	CE, CUL, (CCC)	75

Order no.	Approvals	Catalogue page	Order no.	Approvals	Catalogue page
IE5350	CE, CUL, (CCC)	75	IF5759	CCC, CE	113
IE5351	CE, CUL, (CCC)	70	IF5760	CCC, CE, CUL	113
IE5352	CE, CUL, (CCC)	70	IF5796	CE, (CCC)	112
IE5366	CE, CUL, (CCC)	75	IF5813	CE, (CCC)	113
IE5367	CE, CUL, (CCC)	75	IF5815	CE, (CCC)	113
IE5368	CE, CUL, (CCC)	71	IF5851	CE, CUL, (CCC)	113
IE5369	CE, CUL, (CCC)	71	IF6028	CE, (CCC)	85
IE5379	CE, (CCC)	74	IF6029	CE, (CCC)	86
IE5381	CE, (CCC)	97	IF6030	CE, (CCC)	85
IE5382	CE, (CCC)	97	IF6031	CE, (CCC)	86
IE5390	CE, (CCC)	101	IF6074	CE	87
IE5391	CE, (CCC)	101	IF9222	CCC, CE	99
IE9203	CCC, CE	99	IF9920	CCC, CE	99
IE9902	CCC, CE	99	IF9924	CCC, CE	99
IE9940	CE, (CCC)	99	IFC200	CE, CUL, (CCC)	95
IEC200	CE, CUL, (CCC)	105	IFC201	CE, CUL, (CCC)	96
IEC201	CE, CUL, (CCC)	105	IFC202	CE, CUL, (CCC)	95
IEC202	CE, CUL, (CCC)	105	IFC204	CE, CUL, (CCC)	96
IEC203	CE, CUL, (CCC)	105	IFC205	CE, CUL, (CCC)	96
IER200	CE, CUL, (CCC)	108	IFC206	CE, CUL, (CCC)	102, 96
IER201	CE, CUL, (CCC)	107	IFC207	CE, CUL, (CCC)	98
IER203	CE, CUL, (CCC)	106	IFC208	CE, CUL, (CCC)	98
IER204	CE, CUL, (CCC)	107	IFC209	CE, CUL, (CCC)	102, 98
IER205	CE, CUL, (CCC)	107	IFC210	CE, CUL, (CCC)	101, 96
IER206	CE, CUL, (CCC)	106	IFC229	CE, (CCC)	96
IF0001	CCC, CE	83	IFC230	CE, (CCC)	96
IF0003	CCC, CE	83	IFC234	CE, (CCC)	98
IF0005	CCC, CE	83	IFC235	CE, (CCC)	98
IF0007	CCC, CE	83	IFC237	CE, CUL, (CCC)	96
IF503A	CE	116	IFC238	CE, CUL, (CCC)	96
IF504A	CE	117	IFC239	CE, CUL, (CCC)	99
IF505A	CE	116	IFC241	CE, CUL, (CCC)	99
IF5188	CE, (CCC)	71	IFC243	CE, CUL, (CCC)	100
IF5249	CE, (CCC)	71	IFC246	CE, CUL, (CCC)	101
IF5297	CE, (CCC)	71	IFC247	CE, CUL, (CCC)	102, 618
IF5313	CE, CCC	71	IFC248	CE, CUL, (CCC)	618
IF5329	CE, (CCC)	71	IFC258	CE, CUL, (CCC)	105
IF5345	CE, (CCC)	71	IFC259	CE, CUL, (CCC)	101
IF5514	CE, (CCC)	112	IFC263	CE, CUL, (CCC)	106
IF5594	CE, (CCC)	112	IFC264	CE, CUL, (CCC)	106
IF5597	CE, CCC	73	IFC266	CE, CUL, (CCC)	105
IF5598	CCC, CE, CUL	74	IFM203	CE, CUL, E1, (CCC)	723
IF5644	CE, CCC	73	IFM204	CE, E1, (CCC)	723
IF5645	CCC, CE	73	IFM205	CCC, CE, CUL, E1	723
IF5646	CCC, CE	73	IFM206	CCC, CE, CUL, E1	723
IF5647	CCC, CE, CUL	74	IFM207	CE, CUL, E1, (CCC)	722
IF5670	CE, CUL, (CCC)	104	IFM208	CE, CUL, E1, (CCC)	723
IF5675	CE, CUL, (CCC)	104	IFM209	CCC, CE, CUL, E1	722
IF5750	CE, CUL, (CCC)	104	IFM210	CCC, CE, CUL, E1	722
IF5751	CE, CUL, (CCC)	104	IFR200	CE, CUL, (CCC)	108

Order no.	Approvals	Catalogue page	Order no.	Approvals	Catalogue page
IFR202	CE, CUL, (CCC)	107	IFT201	CE, CUL, (CCC)	112
IFR203	CE, CUL, (CCC)	106	IFT202	CE, CUL, (CCC)	110
IFR204	CE, CUL, (CCC)	107	IFT203	CE, CUL, (CCC)	111
IFR205	CE, CUL, (CCC)	107	IFT204	CE, CUL, (CCC)	112
IFR206	CE, (CCC)	106	IFT205	CE, CUL, (CCC)	110
IFS200	CE, CUL, (CCC)	67	IFT206	CE, CUL, (CCC)	110
IFS201	CE, CUL, (CCC)	67	IFT207	CE, CUL, (CCC)	109
IFS204	CE, CUL, (CCC)	67	IFT208	CE, CUL, (CCC)	110
IFS205	CE, CUL, (CCC)	67	IFT209	CE, CUL, (CCC)	109
IFS206	CE, CUL, (CCC)	68	IFT210	CE, CUL, (CCC)	110
IFS207	CE, CUL, (CCC)	68	IFT216	CE, CUL, (CCC)	111
IFS208	CE, CUL, (CCC)	67	IFT217	CE, CUL, (CCC)	111
IFS209	CE, CUL, (CCC)	67	IFT240	CE, CUL, (CCC)	109
IFS210	CE, CUL, (CCC)	69	IFT243	CE, (CCC)	109
IFS211	CE, CUL, (CCC)	69	IFT244	CE, CUL, (CCC)	108
IFS212	CE, CUL, (CCC)	67	IFT245	CE, CUL, (CCC)	108
IFS213	CE, CUL, (CCC)	68	IFT246	CE, CUL, (CCC)	108
IFS214	CE, CUL, (CCC)	73	IFW200	CE, CUL, (CCC)	103
IFS215	CE, CUL, (CCC)	74	IFW201	CE, CUL, (CCC)	103
IFS216	CE, CUL, (CCC)	74	IG0005	CE, CUL, CCC	83
IFS217	CE, CUL, (CCC)	74	IG0006	CE, CUL, CCC	83
IFS240	CE, CUL, (CCC)	93	IG0011	CCC, CE, CUL	83
IFS241	CE, CUL, (CCC)	93	IG0012	CCC, CE	83
IFS242	CE, CUL, (CCC)	92	IG001A	CCC, CE	117
IFS243	CE, CUL, (CCC)	92	IG510A	CE	116
IFS244	CE, CUL	93	IG511A	CE	116
IFS245	CE, CUL	93	IG512A	CE	117
IFS246	CE, CUL	92	IG513A	CE	117
IFS247	CE, CUL	92	IG514A	CE	117
IFS248	CE, CUL	94	IG515A	CE	117
IFS249	CE, CUL	93	IG5202	CE, (CCC)	112
IFS250	CE, CUL	94	IG5221	CE, (CCC)	71
IFS251	CE, CUL	94	IG5285	CE, (CCC)	71
IFS252	CE, UL	91	IG5397	CE, (CCC)	71
IFS253	CE, UL	91	IG5398	CE, (CCC)	72
IFS254	CE, UL	89	IG5399	CE, (CCC)	72
IFS255	CE, UL	89	IG5401	CE, (CCC)	72
IFS256	CE, UL	91	IG5533	CCC, CE	73
IFS257	CE, UL	91	IG5593	CE, CCC	73
IFS258	CE, UL	89	IG5594	CCC, CE	73
IFS259	CE, UL	89	IG5595	CCC, CE, CUL	75
IFS260	CE, CUL	94	IG5596	CCC, CE	73
IFS261	CE, CUL	94	IG5597	CCC, CE	75
IFS262	CE, CUL	94	IG5602	CE, (CCC)	113
IFS263	CE, CUL	94	IG5647	CE, CUL, (CCC)	104
IFS280	CE, UL, (CCC)	89	IG5667	CE, CUL, (CCC)	104
IFS281	CE, UL, (CCC)	90	IG5682	CCC, CE	99
IFS282	CE, UL, (CCC)	90	IG5718	CCC, CE	76
IFS283	CE, UL, (CCC)	90	IG5719	CCC, CE	76
IFT200	CE, CUL, (CCC)	111	IG5772	CCC, CE, CUL	113

(CCC) = CCC approval is not required

Order no.	Approvals	Catalogue page	Order no.	Approvals	Catalogue page
IG5806	CCC, CE	113	IGR205	CE, CUL, (CCC)	107
IG5813	CE, (CCC)	113	IGR206	CE, (CCC)	106
IG5846	CE, (CCC)	114	IGS200	CE, CUL, (CCC)	67
IG5953	CE, (CCC)	69	IGS201	CE, CUL, (CCC)	67
IG5954	CE, (CCC)	69	IGS204	CE, CUL, (CCC)	68
IG6083	CE, (CCC)	85	IGS205	CE, CUL, (CCC)	68
IG6084	CE, (CCC)	86	IGS206	CE, CUL, (CCC)	68
IG6086	CE, (CCC)	85	IGS207	CE, CUL, (CCC)	69
IG6087	CE, (CCC)	86	IGS208	CE, CUL, (CCC)	67
IG6119	CE	87	IGS209	CE, CUL, (CCC)	67
IG6614	CE	87	IGS210	CE, CUL, (CCC)	69
IG9983	CCC, CE	99	IGS212	CE, CUL, (CCC)	68
IG9984	CCC, CE	99	IGS213	CE, CUL, (CCC)	68
IGC200	CE, CUL, (CCC)	96	IGS214	CE, CUL, (CCC)	74
IGC201	CE, CUL, (CCC)	96	IGS216	CE, CUL, (CCC)	74
IGC202	CE, CUL, (CCC)	95	IGS217	CE, CUL, (CCC)	74
IGC203	CE, CUL, (CCC)	95	IGS232	CE, CUL, (CCC)	93
IGC204	CE, CUL, (CCC)	97	IGS233	CE, CUL, (CCC)	93
IGC205	CE, CUL, (CCC)	97	IGS234	CE, CUL, (CCC)	92
IGC206	CE, CUL, (CCC)	97	IGS235	CE, CUL, (CCC)	92
IGC207	CE, CUL, (CCC)	98	IGS236	CE, CUL	93
IGC208	CE, CUL, (CCC)	98	IGS237	CE, CUL	93
IGC209	CE, CUL, (CCC)	102, 98	IGS238	CE, CUL	92
IGC210	CE, CUL, (CCC)	101, 96	IGS239	CE, CUL	92
IGC220	CE, CUL, (CCC)	97	IGS240	CE, CUL	95
IGC221	CE, CUL, (CCC)	97	IGS241	CE, CUL	94
IGC222	CE, (CCC)	98	IGS242	CE, CUL	95
IGC223	CE, (CCC)	98	IGS243	CE, CUL	94
IGC224	CE, CUL, (CCC)	97	IGS244	CE, UL	91
IGC225	CE, CUL, (CCC)	97	IGS245	CE, UL	91
IGC232	CE, CUL, (CCC)	101	IGS246	CE, UL	90
IGC233	CE, CUL, (CCC)	101	IGS247	CE, UL	90
IGC234	CE, CUL, (CCC)	102, 618	IGS248	CE, UL	91
IGC235	CE, CUL, (CCC)	102, 618	IGS249	CE, UL	91
IGC248	CE, CUL, (CCC)	105	IGS250	CE, UL	90
IGC249	CE, CUL, (CCC)	106	IGS251	CE, UL	90
IGC250	CE, CUL, (CCC)	106	IGS252	CE, CUL	95
IGC252	CE, CUL, (CCC)	105	IGS253	CE, CUL	95
IGM200	CE, CUL, E1, (CCC)	724	IGS254	CE, CUL	94
IGM201	CE, CUL, E1, (CCC)	724	IGS255	CE, CUL	94
IGM202	CE, CUL, E1, (CCC)	723	IGS269	CE, UL, (CCC)	90
IGM203	CE, CUL, E1, (CCC)	723	IGS270	CE, UL, (CCC)	90
IGM204	CCC, CE, CUL, E1	723	IGS271	CE, UL, (CCC)	90
IGM205	CCC, CE, CUL, E1	723	IGS272	CE, UL, (CCC)	90
IGM206	CCC, CE, CUL, E1	722	IGT200	CE, CUL, (CCC)	111
IGM207	CCC, CE, CUL, E1	722	IGT201	CE, CUL, (CCC)	112
IGR200	CE, CUL, (CCC)	108	IGT202	CE, CUL, (CCC)	110
IGR202	CE, CUL, (CCC)	107	IGT203	CE, CUL, (CCC)	111
IGR203	CE, CUL, (CCC)	106	IGT204	CE, CUL, (CCC)	112
IGR204	CE, CUL, (CCC)	107	IGT205	CE, CUL, (CCC)	110

Order no.	Approvals	Catalogue page	Order no.	Approvals	Catalogue page
IGT206	CE, CUL, (CCC)	110	IIC209	CE, (CCC)	98
IGT207	CE, CUL, (CCC)	109	IIC210	CE, CUL, (CCC)	97
IGT208	CE, CUL, (CCC)	110	IIC211	CE, CUL, (CCC)	97
IGT209	CE, CUL, (CCC)	109	IIC213	CE, CUL, (CCC)	100
IGT219	CE, CUL, (CCC)	111	IIC218	CE, CUL, (CCC)	101
IGT220	CE, CUL, (CCC)	111	IIC219	CE, CUL, (CCC)	101
IGT240	CE, CUL, (CCC)	112	IIC220	CE, CUL, (CCC)	102, 618
IGT247	CE, CUL, (CCC)	109	IIC221	CE, CUL, (CCC)	102, 618
IGT248	CE, CUL, (CCC)	108	IIC224	CE, CUL, (CCC)	105
IGT249	CE, CUL, (CCC)	109	IIC226	CE, CUL, (CCC)	105
IGT250	CE, CUL, (CCC)	108	IIM200	CE, CUL, E1, (CCC)	724
IGW200	CE, CUL, (CCC)	103	IIM201	CE, CUL, E1, (CCC)	724
IGW201	CE, CUL, (CCC)	103	IIM202	CE, CUL, E1, (CCC)	723
IIO005	CE, CCC	83	IIM203	CE, CUL, E1, (CCC)	723
IIO006	CE, CCC	84	IIM208	CCC, CE, CUL, E1	723
IIO011	CE, CUL, CCC	84	IIM209	CCC, CE, CUL, E1	723
IIO012	CE, CUL, CCC	84	IIM210	CCC, CE, CUL, E1	722
IIO01A	CCC, CE	117	IIM211	CCC, CE, CUL, E1	722
IIS02A	CE	116	IIR200	CE, CUL, (CCC)	108
IIS03A	CE	116	IIR202	CE, CUL, (CCC)	107
IIS04A	CE, IEC	119	IIR203	CE, CUL, (CCC)	106
IIS166	CE, (CCC)	72	IIR204	CE, CUL, (CCC)	107
IIS256	CE, (CCC)	72	IIR205	CE, CUL, (CCC)	107
IIS284	CE, (CCC)	72	IIR206	CE, (CCC)	107
IIS300	CE, (CCC)	72	IIS204	CE, CUL, (CCC)	68
IIS346	CE, (CCC)	72	IIS205	CE, CUL, (CCC)	68
IIS369	CE, (CCC)	72	IIS206	CE, CUL, (CCC)	67
IIS436	CCC, CE	73	IIS207	CE, CUL, (CCC)	67
IIS488	CE, CCC	73	IIS208	CE, CUL, (CCC)	69
IIS489	CE, CCC	73	IIS209	CE, CUL, (CCC)	69
IIS490	CE, CCC	75	IIS210	CE, CUL, (CCC)	68
IIS491	CCC, CE	73	IIS211	CE, CUL, (CCC)	68
IIS492	CE, CCC	75	IIS226	CE, CUL, (CCC)	93
IIS493	CE, CCC	73	IIS227	CE, CUL, (CCC)	93
IIS503	CE, CUL, (CCC)	104	IIS228	CE, CUL, (CCC)	92
IIS689	CE, CUL, (CCC)	113	IIS229	CE, CUL, (CCC)	92
IIS733	CCC, CE	113	IIS230	CE, CUL	93
IIS751	CCC, CE	113	IIS231	CE, CUL	93
IIS776	CE, (CCC)	113	IIS232	CE, CUL	92
IIS913	CE, (CCC)	85	IIS233	CE, CUL	93
IIS914	CE, (CCC)	86	IIS234	CE, CUL	95
IIS916	CE, (CCC)	86	IIS235	CE, CUL	94
IIS917	CE, (CCC)	86	IIS236	CE, CUL	95
IIS930	CE, (CCC)	87	IIS237	CE, CUL	94
IIS961	CE	87	IIS238	CE, UL	92
IIC200	CE, CUL, (CCC)	97	IIS239	CE, UL	92
IIC201	CE, CUL, (CCC)	97	IIS240	CE, UL	90
IIC206	CE, CUL, (CCC)	102, 97	IIS241	CE, UL	90
IIC207	CE, CUL, (CCC)	97	IIS242	CE, UL	92
IIC208	CE, (CCC)	98	IIS243	CE, UL	92

Order no.	Approvals	Catalogue page	Order no.	Approvals	Catalogue page
IIS244	CE, UL	91	IM5115	CE, CUL, (CCC)	79
IIS245	CE, UL	91	IM5116	CE, CUL, (CCC)	79
IIS246	CE, CUL	95	IM5117	CE, CUL, (CCC)	80
IIS247	CE, CUL	95	IM5118	CE	618, 79
IIS248	CE, CUL	94	IM5119	CE, CUL, (CCC)	103, 80
IIS249	CE, CUL	94	IM511A	CE	116
IIS263	CE, UL, (CCC)	91	IM5120	CE, CUL, (CCC)	103, 80
IIS264	CE, UL, (CCC)	91	IM5123	CE, CUL, (CCC)	81
IIS265	CE, UL, (CCC)	91	IM5124	CE, CUL, (CCC)	103, 80
IIS266	CE, UL, (CCC)	91	IM5125	CE, CUL, (CCC)	103, 80
IIT002	CCC, CE, CUL	109	IM5126	CE, CUL, (CCC)	103, 80
IIT200	CE, CUL, (CCC)	111	IM5127	CE, (CCC)	100
IIT202	CE, CUL, (CCC)	110	IM5128	CE, CUL, (CCC)	80
IIT204	CE, CUL, (CCC)	111	IM5129	CE, CUL, (CCC)	103, 80
IIT205	CE, CUL, (CCC)	111	IM512A	CE	116
IIT206	CE, CUL, (CCC)	110	IM5130	CE, CUL, (CCC)	80
IIT207	CE, CUL, (CCC)	110	IM5131	CE, CUL, (CCC)	80
IIT208	CE, CUL, (CCC)	110	IM5132	CE, CUL, (CCC)	103, 81
IIT209	CE, CUL, (CCC)	110	IM5133	CE, CUL, (CCC)	104, 81
IIT212	CE, CUL, (CCC)	111	IM5134	CE, CUL, (CCC)	81
IIT213	CE, CUL, (CCC)	111	IM5135	CE, CUL, (CCC)	104, 81
IIT228	CE, CUL, (CCC)	109	IM5136	CE, CUL, (CCC)	81
IIT230	CE, CUL, (CCC)	108	IM5137	CE, (CCC)	100
IIT231	CE, CUL, (CCC)	109	IM5138	CE, (CCC)	100
IIT232	CE, CUL, (CCC)	108	IM5139	CE, CUL, (CCC)	86
IIW200	CE, CUL, (CCC)	103	IM513A	CE	116
IIW201	CE, CUL, (CCC)	103	IM5140	CE, CUL, (CCC)	86
IL5002	CE, CUL, (CCC)	78	IM5141	CE, CUL, (CCC)	86
IL5003	CE, CUL, (CCC)	78	IM5142	CE, CUL, (CCC)	86
IL5004	CE, CUL, (CCC)	81	IN0073	CCC, CE	84
IL5005	CE, CUL, (CCC)	81	IN0077	CCC, CE	84
IL5020	CE, CUL, (CCC)	78	IN0081	CCC, CE	84
IL5022	CE, CUL, (CCC)	78	IN0085	CCC, CE	84
IM0010	CCC, CE, CUL	85	IN0108	CCC, CE, CUL	315, 573
IM0011	CCC, CE, CUL	85	IN0110	CCC, CE	314, 572
IM001A	CE	118	IN507A	CE	317, 575
IM002A	CE	118	IN508A	CE	575
IM0049	CCC, CE	83	IN509A	CE	575
IM0053	CCC, CE	84	IN5121	CE, (CCC)	78
IM0054	CCC, CE	84	IN5129	CE, (CCC)	78
IM5019	CE, CUL, (CCC)	82	IN512A	CE	317
IM5020	CE, CUL, (CCC)	82	IN5186	CE, (CCC)	79
IM5037	CCC, CE	82	IN5188	CE, (CCC)	79
IM5038	CCC, CE	82	IN5207	CE, CCC	79
IM5046	CE, (CCC)	82	IN5208	CCC, CE, CUL	79
IM506A	CE	118	IN5212	CE, CUL, (CCC)	81
IM507A	CE	118	IN5224	CE, (CCC)	314, 572
IM508A	CE	118	IN5225	CE, CUL, (CCC)	314, 572
IM509A	CE	117	IN5230	CE, CUL, (CCC)	81
IM510A	CE	117	IN5251	CE, (CCC)	314, 572

Order no.	Approvals	Catalogue page	Order no.	Approvals	Catalogue page
IN5281	CE, E1, (CCC)	722	JAC201	CE, (CCC)	204
IN5282	CE, E1, (CCC)	722	JAT201	CE, (CCC)	204
IN5285	CE, CUL, (CCC)	314, 572	JN2100	CE	354, 721
IN5304	CE, (CCC)	314, 572	JN2101	CE	354, 721
IN5323	CE, (CCC)	314, 572	JN2200	CE	354
IN5327	CE, CUL, (CCC)	314, 572	JN2201	CE	354
IN5331	CE, (CCC)	314, 572	JN2300	CE	354
IN5334	CE, CUL, (CCC)	315, 573	JN2301	CE	354
IN5409	CE, (CCC)	315, 573	KD0009	CCC, CE	155
IO5016	CE, (CCC)	100	KD0012	CCC, CE	154
IO5017	CE, (CCC)	100	KD001A	CE	157
IO5018	CE, (CCC)	100	KD5018	CE, (CCC)	154
IS5001	CE, CUL, (CCC)	78	KD501A	CE	157
IS5026	CE, CUL, (CCC)	79	KD5022	CE, (CCC)	152
IS5031	CE, CUL, (CCC)	79	KD5039	CE, (CCC)	153
IS5035	CE, CUL, (CCC)	81	KF5001	CE, CUL	153
IS5070	CE, (CCC)	79	KF5002	CE, CUL	153
IS5071	CE, CUL, (CCC)	81	KF5013	CE, CUL	153
IT5001	CE, (CCC)	76	KF5014	CE, UL	152
IT5021	CE, CUL, (CCC)	77	KF5015	CE, UL	152
IT5034	CE, CUL, (CCC)	77	KG0008	CCC, CE	155
IT5039	CE, CUL, (CCC)	76	KG0009	CCC, CE	154
IT5040	CE, CUL, (CCC)	77	KG0010	CCC, CE	154
IT5042	CE, CUL, (CCC)	76	KG0016	CCC, CE	154
IT5044	CE, CUL, (CCC)	77	KG5040	CCC, CE	154
IV5003	CE	82	KG5041	CE	153
IV5004	CE	82	KG5043	CE, UL, (CCC)	152
IV5025	CE	104	KG5047	CCC, CE	152
IW5051	CE, (CCC)	79	KG5057	CE, (CCC)	153
IW5053	CE, (CCC)	79	KG5066	CE, CUL	153
IW5058	CE, (CCC)	79	KG5069	CE, CUL	152
IW5062	CE, (CCC)	82	KG5071	CE, CUL	153
IW5064	CE, CUL, (CCC)	82	KI000A	CE	157
IX5002	CE, (CCC)	317, 575	KI0016	CCC, CE, CUL	154
IX5006	CE, (CCC)	317, 575	KI001A	CE	157
IX5010	CE, (CCC)	317, 576	KI0020	CCC, CE, CUL	154
IX5030	CE, (CCC)	318, 576	KI0024	CCC, CE, CUL	155
IY5029	CE, (CCC)	72	KI0054	CCC, CE, CUL	155
IY5036	CE, CUL, (CCC)	75	KI5002	CE, CUL, (CCC)	152
IY5048	CE, CUL, (CCC)	75	KI5015	CE, CUL, (CCC)	152
IY5049	CE, CUL, (CCC)	72	KI5019	CE, CUL, (CCC)	152
IY5051	CE, (CCC)	72	KI5023	CCC, CE, CUL	154
IY5052	CE, (CCC)	72	KI5024	CE, CUL, (CCC)	154
IZ5026	CE, CUL, (CCC)	76	KI5030	CCSAUS, CE, FM, IEC	156
IZ5035	CE, CUL, (CCC)	77	KI5031	CCSAUS, CE, FM	156
IZ5046	CE, CUL, (CCC)	77	KI503A	CE	157
IZ5047	CE, CUL, (CCC)	76	KI505A	CE	157
IZ5048	CE, CUL, (CCC)	76	KI5082	CE, CUL	153
IZ5051	CE, (CCC)	76	KI5083	CE, CUL	153
IZ5052	CE, (CCC)	77	KI5085	CE, CUL	153

(CCC) = CCC approval is not required

Order no.	Approvals	Catalogue page	Order no.	Approvals	Catalogue page
KI5087	CE, CUL	153	LK3122	CE, CUL	508
KI5207	CE, CSA, CUL, (CCC)	152	LK3123	CE, CUL	508
KN5121	CE, (CCC)	152	LK3124	CE, CUL	508
KQ5100	CE, UL	155	LK7022	CE, CUL	508
KQ5101	CE, UL	156	LK7023	CE, CUL	508
KQ5102	CE, UL	156	LK7024	CE, CUL	509
KQ6001	CE, CUL	155	LK8122	CE, CUL	509
KQ6002	CE, CUL	155	LK8123	CE, CUL	509
KQ6003	CE, CUL	156	LK8124	CE, CUL	509
KQ6004	CE, CUL	156	LL8022	CE, CUL	513
KQ6005	CE, CUL	156	LL8023	CE, CUL	513
KQ6006	CE, UL	155	LL8024	CE, CUL	513
KQ6007	CE, CUL	156	LMT100	CE, CUL, EC19352004, EHEDG, FDA	511
KT5010	CE	158	LMT102	CE, CRN, CUL, EC19352004, EHEDG, FDA	511
KT5011	CE	158	LMT104	CE, CUL, EC19352004, EHEDG, FDA	511
KT5012	CE	159	LMT105	CE, CUL, EC19352004, EHEDG, FDA	511
KT5013	CE	159	LMT110	CE, CUL, EC19352004, EHEDG, FDA	511
KT5050	CE	159	LMT121	CE, CRN, CUL, EC19352004, EHEDG, FDA	511
KT5102	CE	158	LMT191	CE, CUL, WHG	510
KT5106	CE	159	LMT192	CE, CUL, WHG	510
KT5110	CE	159	LMT194	CE, CUL, WHG	510
KT5111	CE	159	LMT195	CE, CUL, WHG	510
KT5112	CE	159	LMT202	CE, CUL, EC19352004, FDA	511
KT5150	CE	160	LMT292	CE, CUL, WHG	510
KT5151	CE	160	LMT302	CE, CUL, EC19352004, FDA	511
KT5309	CE	158	LMT392	CE, CUL, WHG	510
KT5310	CE	159	LR2050	CE, CUL	511
KT5350	CE	160	LR2750	CE, CUL, EC19352004, FDA	511
KT5351	CE	160	LR3000	CE, CUL	512
KX5001	CCSAUS, CE, FM	156	LR3300	CE, CUL	512
KX5002	CCSAUS, CE, FM	157	LR7000	CE, CUL	512
KX5004	CCSAUS, CE, FM	157	LR7300	CE, CUL	512
LDH100	CE	678	LR8000	CE, CUL	512
LDP100	CE	678	LR8300	CE, CUL	512
LI2141	CE, CUL	509	LR9020	CE, CUL	512
LI2142	CE, CUL	509	LT8022	CE, CUL	512
LI2143	CE, CUL	509	LT8023	CE, CUL	512
LI2241	CE, CUL	509	LT8024	CE, CUL	512
LI2242	CE, CUL	509	M9H200	CE	172, 725
LI2243	CE, CUL	509	ME5010	CE, CUL, (CCC)	174
LI5141	CE, CUL	510	ME5011	CE, CUL, (CCC)	173
LI5142	CE, CUL	510	ME5015	CE, (CCC)	173
LI5143	CE, CUL	510	MF5004	CE, (CCC)	174, 725
LI5144	CE, CUL	510	MFH200	CE	172, 724
LK1022	CE, CUL	508	MFH201	CE	172, 724
LK1023	CE, CUL	508	MFH202	CE	172, 724
LK1024	CE, CUL	508	MFH203	CE	172, 724
LK1222	CE	508	MFH204	CE	172, 724
LK1223	CE	508	MFS200	CE, CUL, (CCC)	174
LK1224	CE	508	MFS201	CE, CUL, (CCC)	173

Order no.	Approvals	Catalogue page	Order no.	Approvals	Catalogue page
MFS202	CE, CUL, (CCC)	173	MK5186	CE, UL, (CCC)	185
MFS203	CE, CUL, (CCC)	174	MK5208	CE	188
MFS209	CE, CUL, (CCC)	173	MK5209	CE, (CCC)	189
MFS210	CE, CUL, (CCC)	173	MK5214	CE	188
MFS211	CE, CUL, (CCC)	172	MK5215	CE	188
MFT200	CE, CUL, (CCC)	175	MK5300	CE, CUL, (CCC)	189
MFT202	CE, CUL, (CCC)	174	MK5301	CE, CUL, (CCC)	189
MFT204	CE, CUL, (CCC)	175	MK5302	CE, CUL, (CCC)	189
MGS200	CE, CUL, (CCC)	174	MK5304	CE, CUL, (CCC)	189
MGS201	CE, CUL, (CCC)	173	MK5305	CE, CUL, (CCC)	189
MGS202	CE, (CCC)	173	MK5306	CE, CUL, (CCC)	189
MGS204	CE, CUL, (CCC)	172	MK5307	CE, CUL, (CCC)	189
MGS205	CE, CUL, (CCC)	173	MK5308	CE, CUL, (CCC)	190
MGS206	CE, CUL, (CCC)	173	MK5309	CE, CUL, (CCC)	190
MGT200	CE, CUL, (CCC)	175	MK5310	CE, CUL, (CCC)	190
MGT201	CE, (CCC)	175	MK5311	CE, CUL, (CCC)	190
MGT203	CE, CUL, (CCC)	175	MK5312	CE, CUL, (CCC)	190
MK500A	CE	187	MK5314	CE, CUL, (CCC)	190
MK501A	CE	187	MK5315	CE, CUL, (CCC)	190
MK502A	CE, IEC	187	MK5325	CE, CUL, (CCC)	190
MK503A	CE, (CCC)	187	MK5326	CE, CUL, (CCC)	191
MK5100	CE, CUL, (CCC)	182	MK5328	CE, (CCC)	191
MK5101	CE, CUL, (CCC)	182	MK5329	CE, (CCC)	191
MK5102	CE, CUL, (CCC)	183	MK5330	CE, (CCC)	191
MK5103	CE, CUL, (CCC)	182	MK5331	CE, (CCC)	191
MK5104	CE, CUL, (CCC)	182	MK5900	CE, CUL, (CCC)	183
MK5105	CE, CUL, (CCC)	183	MK5902	CE, CUL, (CCC)	183
MK5106	CE, CUL, (CCC)	182	MN5200	CE, (CCC)	174, 725
MK5107	CE, CUL, (CCC)	183	MR0100	CCC, CE, UL	184
MK5108	CE, CUL, (CCC)	183	MR0101	CCC, CE, UL	184
MK5109	CE, CUL, (CCC)	183	MR0102	CCC, CE, UL	184
MK5110	CE, CUL, (CCC)	185	MR0107	CCC, CE, UL	184
MK5111	CE, CUL, (CCC)	185	MR0117	CCC, CE, UL	184
MK5112	CE, CUL, (CCC)	182	MR0119	CCC, CE, UL	184
MK5114	CE, CUL, (CCC)	182	MR0120	CCC, CE, UL	184
MK5115	CE, CUL, (CCC)	182	MR0121	CCC, CE, UL	185
MK5117	CE, CUL, (CCC)	182	MR0122	CCC, CE, UL	184
MK5122	CE, CUL, (CCC)	183	MR0123	CCC, CE, UL	185
MK5124	CE, CUL, (CCC)	182	MR0901	CCC, CE, CUL	183
MK5128	CE, CUL, (CCC)	185	MR0902	CCC, CE, CUL	185
MK5137	CE, CUL, (CCC)	186	MR500A	CE, IEC	188
MK5138	CE, CUL, (CCC)	186	MR501A	CE, (CCC)	188
MK5139	CE, CUL, (CCC)	186	MS5010	CE, CUL, (CCC)	174
MK5140	CE, CUL, (CCC)	186	MS5011	CE, CUL, (CCC)	174
MK5155	CE, CUL, (CCC)	186	MS5013	CE, (CCC)	174
MK5156	CE, CUL, (CCC)	186	MX5000	CE	348
MK5157	CE, CUL, (CCC)	187	MX5004	CE	348
MK5158	CE, CUL, (CCC)	187	MX5015	CE	347
MK5159	CE, CUL, (CCC)	186	MX5017	CE	347
MK5161	CE, CUL, (CCC)	186	MX5050	CE	348

(CCC) = CCC approval is not required

Order no.	Approvals	Catalogue page	Order no.	Approvals	Catalogue page
N0030A	CE, CSA, FM	157, 328	O1D155	CE, CUL, (CCC)	276
N0031A	CE	119, 158	O1D300	CE, CUL, (CCC)	277, 307
N0032A	CE, CSA, FM	119, 158	O2D220	CE, CUL, (CCC)	369
N0033A	CE	119, 158	O2D222	CE, CUL, (CCC)	369
N0530A	CE	120, 158	O2D224	CE, CUL, (CCC)	369
N0531A	CE, CSA, FM, IEC	120, 158	O2D225	CE, CUL, (CCC)	369
N0532A	CE, CSA, FM, IEC	120, 158	O2D227	CE, CUL, (CCC)	369
N0533A	CE	120, 158	O2D229	CE, CUL, (CCC)	369
N0534A	CE, CSA, FM, IEC	120, 158	O2D900	CE, CUL, (CCC)	383
N7S20A	CE, FM, IEC	119	O2D901	CE, CUL, (CCC)	383
N7S21A	CE, FM, IEC	119	O2D902	CE, CUL, (CCC)	383
N7S23A	CE, IEC	119	O2D903	CE, CUL, (CCC)	383
N95001	CE, IEC	316, 574	O2D904	CE, CUL, (CCC)	383
N95002	CE	316, 574	O2D905	CE, CUL, (CCC)	383
NE5001	CCSAUS, CE, FM	114	O2D906	CE, (CCC)	383
NF5001	CCSAUS, CE, FM	114	O2D907	CE, (CCC)	384
NF5002	CE, CCSAUS, FM, IEC	114	O2D908	CE, (CCC)	384
NF5003	CCSAUS, CE, FM	114	O2D909	CE, (CCC)	384, 656
NF5004	CCSAUS, CE, FM	114	O2D910	CE, (CCC)	383
NF500A	CE, CCSAUS, FM, IEC	115	O2D911	CE, (CCC)	383
NF501A	CE, CCSAUS, FM, IEC	115	O2D912	CE, (CCC)	384
NG5001	CCSAUS, CE, FM	114	O2D913	CE, (CCC)	384, 656
NG5002	CE, CCSAUS, FM, IEC	114	O2D915	CE, (CCC)	382
NG5003	CCSAUS, CE, FM	114	O2D917	CE, (CCC)	382, 656
NG5004	CCSAUS, CE, FM	114	O2D919	CE, (CCC)	382
NG500A	CE, CCSAUS, FM, IEC	115	O2D920	CE, (CCC)	383
NG501A	CE, CCSAUS, FM, IEC	115	O2D921	CE, (CCC)	382
NI5001	CCSAUS, CE, FM	114	O2D922	CE, (CCC)	382, 656
NI5002	CE, CCSAUS, FM, IEC	114	O2D923	CE, (CCC)	383
NI5003	CCSAUS, CE, FM	115	O2D924	CE, (CCC)	382
NI5004	CCSAUS, CE, FM	115	O2D925	CE, (CCC)	382, 656
NI500A	CE, CCSAUS, FM, IEC	115	O2D926	CE, (CCC)	383
NI501A	CE, CCSAUS, FM, IEC	115	O2I100	CE, CUL, (CCC)	654
NM500A	CE, CCSAUS, FM, IEC	116	O2I101	CE, CUL, (CCC)	654
NM501A	CE, CCSAUS, FM, IEC	116	O2I102	CE, CUL, (CCC)	654
NN5002	CCSAUS, CE, FM	115	O2I103	CE, CUL, (CCC)	654
NN5008	CCSAUS, CE, FM	316, 574	O2I104	CE, CUL, (CCC)	654
NN5009	CCSAUS, CE, FM	316, 574	O2I105	CE, CUL, (CCC)	655
NN5011	CCSAUS, CE, FM	316, 574	O2I300	CE, CUL, (CCC)	655
NN5013	CE, IEC	316, 574	O2I301	CE, CUL, (CCC)	655
NN504A	CE	316, 574	O2I302	CE, CUL, (CCC)	655
NN505A	CE	316, 574	O2I303	CE, CUL, (CCC)	655
NS5002	CCSAUS, CE, FM, IEC	115	O2I304	CE, CUL, (CCC)	655
NT5001	CCSAUS, CE, FM	115	O2I305	CE, CUL, (CCC)	655
O1D100	CE, CUL, (CCC)	277	O2I350	CE, CUL, (CCC)	655
O1D101	CE, CUL, (CCC)	271, 277	O2I351	CE, CUL, (CCC)	655
O1D103	CE, CUL, (CCC)	277	O2I352	CE, CUL, (CCC)	655
O1D104	CE, CUL, (CCC)	271, 277	O2I353	CE, CUL, (CCC)	655
O1D105	CE, CUL, (CCC)	277	O2I354	CE, CUL, (CCC)	655
O1D106	CE, CUL, (CCC)	277	O2I355	CE, CUL, (CCC)	655

Order no.	Approvals	Catalogue page	Order no.	Approvals	Catalogue page
O2M110	CE, E1R, (CCC)	711	O5D101	CE, CUL, (CCC)	276
O2M113	CE, E1R, (CCC)	711	O5D102	CE, CUL, (CCC)	276
O2M200	CE, E4	710	O5D150	CE, CUL, (CCC)	276
O2M201	CE, E4	710	O5D151	CE, CUL, (CCC)	276
O2M202	CE, E4	710	O5E200	CE, CUL, (CCC)	230
O2M203	CE, E4	710	O5E500	CE, CUL, (CCC)	231
O2V100	CE, CUL, (CCC)	368	O5E501	CE, CUL, (CCC)	231
O2V101	CE, CUL, (CCC)	369	O5E502	CE, CUL, (CCC)	231
O2V102	CE, CUL, (CCC)	368	O5E51A	CE, (CCC)	232
O2V103	CE, CUL, (CCC)	369	O5E700	CE, CUL, (CCC)	270
O2V104	CE, CUL, (CCC)	368	O5G500	CE, CUL, (CCC)	306
O2V105	CE, CUL, (CCC)	369	O5H200	CE, CUL, (CCC)	231
O2V120	CE, CUL, (CCC)	368	O5H201	CE, CUL, (CCC)	231
O2V121	CE, CUL, (CCC)	369	O5H500	CE, CUL, (CCC)	232
O2V122	CE, CUL, (CCC)	368	O5H501	CE, CUL, (CCC)	232
O2V123	CE, CUL, (CCC)	369	O5H503	CE, CUL, (CCC)	232
O2V124	CE, CUL, (CCC)	368	O5H504	CE, CUL, (CCC)	232
O2V125	CE, CUL, (CCC)	369	O5H51A	CE, (CCC)	232
O3D200	CE, CUL, (CCC)	374	O5H700	CE, CUL, (CCC)	271
O3D201	CE, CUL, (CCC)	378	O5K500	CE, CUL, (CCC)	306
O3D222	CE, CUL, (CCC)	374	O5P200	CE, CUL, (CCC)	230
O3D223	CE, CUL, (CCC)	378	O5P201	CE, CUL, (CCC)	230
O3D300	CE	374	O5P500	CE, CUL, (CCC)	231
O3D301	CE	378	O5P501	CE, CUL, (CCC)	231
O3D302	CE	374	O5P502	CE, CUL, (CCC)	232
O3D303	CE	378	O5P51A	CE, (CCC)	232
O3D310	CE	374	O5P700	CE, CUL, (CCC)	271
O3D311	CE	378	O5S200	CE, CUL, (CCC)	230
O3D312	CE	374	O5S500	CE, CUL, (CCC)	231
O3D313	CE	378	O5S501	CE, CUL, (CCC)	231
O3M150	CE, E1R	708	O5S51A	CE, (CCC)	232
O3M151	CE, E1R	708	O5S700	CE, CUL, (CCC)	270
O3M950	CE, E1R	708	O6E200	CE, UL, (CCC)	222
O4E200	CE, CUL, (CCC)	233	O6E201	CE, (CCC)	222
O4E201	CE, CUL, (CCC)	233	O6E202	CE, CUL, (CCC)	222
O4E500	CE, CUL, (CCC)	234	O6E203	CE, CUL, (CCC)	222
O4E501	CE, CUL, (CCC)	234	O6E204	CE, UL, (CCC)	222
O4H200	CE, CUL, (CCC)	234	O6E205	CE, (CCC)	222
O4H201	CE, CUL, (CCC)	234	O6E206	CE, CUL, (CCC)	222
O4H500	CE, CUL, (CCC)	235	O6E207	CE, CUL, (CCC)	223
O4H501	CE, CUL, (CCC)	234	O6E215	CE, CUL, (CCC)	223
O4P200	CE, CUL, (CCC)	233	O6E216	CE, CUL, (CCC)	223
O4P201	CE, CUL, (CCC)	234	O6E300	CE, UL, (CCC)	226
O4P500	CE, CUL, (CCC)	234	O6E301	CE, UL, (CCC)	226
O4P501	CE, CUL, (CCC)	234	O6E302	CE, CUL, (CCC)	226
O4S200	CE, CUL, (CCC)	233	O6E303	CE, CUL, (CCC)	226
O4S500	CE, CUL, (CCC)	234	O6E304	CE, UL, (CCC)	226
O4S501	CE, CUL, (CCC)	234	O6E305	CE, UL, (CCC)	226
O5C500	CE, CUL, (CCC)	307	O6E306	CE, CUL, (CCC)	227
O5D100	CE, CUL, (CCC)	276	O6E307	CE, CUL, (CCC)	227

Order no.	Approvals	Catalogue page	Order no.	Approvals	Catalogue page
O6E309	CE, CUL, (CCC)	227	O6S303	CE, CUL, (CCC)	227
O6H200	CE, UL, (CCC)	223	O6S305	CE, CUL, (CCC)	226
O6H201	CE, (CCC)	223	O6T200	CE, UL, (CCC)	225
O6H202	CE, CUL, (CCC)	223	O6T201	CE, (CCC)	225
O6H203	CE, CUL, (CCC)	223	O6T202	CE, CUL, (CCC)	225
O6H204	CE, UL, (CCC)	223	O6T203	CE, CUL, (CCC)	225
O6H205	CE, (CCC)	223	O6T204	CE, UL, (CCC)	225
O6H206	CE, CUL, (CCC)	223	O6T205	CE, (CCC)	225
O6H207	CE, CUL, (CCC)	223	O6T206	CE, CUL, (CCC)	225
O6H210	CE, CUL	228	O6T207	CE, CUL, (CCC)	225
O6H211	CE, CUL	228	O6T215	CE, CUL, (CCC)	225
O6H212	CE, CUL	228	O6T216	CE, CUL, (CCC)	225
O6H213	CE, CUL	228	O6T300	CE, UL, (CCC)	229
O6H214	CE, CUL	228	O6T301	CE, UL, (CCC)	229
O6H300	CE, UL, (CCC)	227	O6T302	CE, CUL, (CCC)	229
O6H301	CE, UL, (CCC)	227	O6T303	CE, CUL, (CCC)	229
O6H302	CE, CUL, (CCC)	227	O6T304	CE, UL, (CCC)	230
O6H303	CE, CUL, (CCC)	227	O6T305	CE, UL, (CCC)	230
O6H304	CE, UL, (CCC)	227	O6T306	CE, CUL, (CCC)	230
O6H305	CE, UL, (CCC)	227	O6T307	CE, CUL, (CCC)	230
O6H306	CE, CUL, (CCC)	228	O6T309	CE, CUL, (CCC)	230
O6H307	CE, CUL, (CCC)	228	O7E200	CE, UL, (CCC)	216
O6H309	CE, CUL, (CCC)	228	O7E201	CE, UL, (CCC)	216
O6H310	CE, CUL, (CCC)	228	O7E202	CE, UL, (CCC)	216
O6P200	CE, UL, (CCC)	224	O7E203	CE, UL, (CCC)	216
O6P201	CE, (CCC)	224	O7H200	CE, UL, (CCC)	217
O6P202	CE, CUL, (CCC)	224	O7H201	CE, UL, (CCC)	217
O6P203	CE, CUL, (CCC)	224	O7H202	CE, UL, (CCC)	217
O6P204	CE, UL, (CCC)	224	O7H203	CE, UL, (CCC)	217
O6P205	CE, (CCC)	224	O7H204	CE, UL, (CCC)	217
O6P206	CE, CUL, (CCC)	224	O7H205	CE, UL, (CCC)	217
O6P207	CE, CUL, (CCC)	224	O7H206	CE, UL, (CCC)	217
O6P300	CE, UL, (CCC)	228	O7H207	CE, UL, (CCC)	217
O6P301	CE, UL, (CCC)	228	O7H208	CE, UL, (CCC)	217
O6P302	CE, CUL, (CCC)	228	O7H209	CE, UL, (CCC)	217
O6P303	CE, CUL, (CCC)	229	O7H210	CE, UL, (CCC)	217
O6P304	CE, UL, (CCC)	229	O7H211	CE, UL, (CCC)	217
O6P305	CE, UL, (CCC)	229	O7P200	CE, UL, (CCC)	216
O6P306	CE, CUL, (CCC)	229	O7P201	CE, UL, (CCC)	216
O6P307	CE, CUL, (CCC)	229	O7P202	CE, UL, (CCC)	216
O6P309	CE, CUL, (CCC)	229	O7P203	CE, UL, (CCC)	217
O6P310	CE, CUL, (CCC)	229	O7S200	CE, UL, (CCC)	216
O6S200	CE, UL, (CCC)	222	OBF500	CE, CUL, (CCC)	286
O6S201	CE, (CCC)	222	OBF501	CE, CUL, (CCC)	286
O6S202	CE, CUL, (CCC)	222	OBF502	CE, CUL, (CCC)	286
O6S203	CE, CUL, (CCC)	224	OBF503	CE, CUL, (CCC)	286
O6S215	CE, CUL, (CCC)	224	OF5010	CE, CUL, (CCC)	203
O6S300	CE, UL, (CCC)	226	OF5012	CE, CUL, (CCC)	204
O6S301	CE, UL, (CCC)	226	OF5014	CE, CUL, (CCC)	203
O6S302	CE, CUL, (CCC)	226	OF5016	CE, CUL, (CCC)	203

Order no.	Approvals	Catalogue page	Order no.	Approvals	Catalogue page
OF5018	CE, CUL, (CCC)	203	OGF302	CE, CUL, (CCC)	209
OF5019	CE, CUL, (CCC)	203	OGF303	CE, CUL, (CCC)	209
OF5021	CE, CUL, (CCC)	203	OGF380	CE, CUL, (CCC)	213
OF5022	CE, CUL, (CCC)	203	OGF381	CE, CUL, (CCC)	213
OF5024	CE, CUL, (CCC)	203	OGF382	CE, CUL, (CCC)	213
OF5025	CE, CUL, (CCC)	203	OGF500	CE, CUL, (CCC)	208
OF5026	CE, CUL, (CCC)	204	OGF502	CE, CUL, (CCC)	207
OF5027	CE, CUL, (CCC)	204	OGF700	CE, CUL, (CCC)	268
OF5032	CE, CUL, (CCC)	204	OGF701	CE, CUL, (CCC)	268
OF5048	CE, CUL, (CCC)	203	OGH080	CE, CUL	213
OF5049	CE, CUL, (CCC)	204	OGH081	CE, CUL	213
OF5050	CE, CUL, (CCC)	203	OGH200	CE, CUL, (CCC)	207
OF5051	CE, CUL, (CCC)	203	OGH280	CE, CUL, (CCC)	212
OF5060	CE, CUL, (CCC)	204	OGH281	CE, CUL, (CCC)	212
OF5062	CE, CUL, (CCC)	203	OGH282	CE, CUL, (CCC)	212
OG0028	CCC, CE	205	OGH283	CE, CUL, (CCC)	212
OG0029	CCC, CE	205	OGH300	CE, CUL, (CCC)	210
OG0030	CCC, CE, CUL	205	OGH301	CE, CUL, (CCC)	210
OG0031	CCC, CE	205	OGH302	CE, CUL, (CCC)	210
OG0032	CCC, CE	206	OGH303	CE, CUL, (CCC)	210
OG0033	CCC, CE	206	OGH304	CE, CUL, (CCC)	210
OG0034	CCC, CE	207	OGH305	CE, CUL, (CCC)	210
OG0035	CCC, CE	207	OGH306	CE, CUL, (CCC)	209
OG0038	CCC, CE	205	OGH307	CE, CUL, (CCC)	209
OG0039	CCC, CE	205	OGH308	CE, CUL, (CCC)	210
OG0040	CCC, CE	207	OGH309	CE, CUL, (CCC)	210
OG0041	CCC, CE	207	OGH310	CE, CUL, (CCC)	210
OG0043	CCC, CE	206	OGH311	CE, CUL, (CCC)	210
OG0044	CCC, CE	206	OGH380	CE, CUL, (CCC)	213
OG0047	CE, CCC	207	OGH381	CE, CUL, (CCC)	213
OG5123	CE, CUL, (CCC)	211	OGH382	CE, CUL, (CCC)	213
OG5124	CE, CUL, (CCC)	211	OGH383	CE, CUL, (CCC)	213
OG5125	CE, CUL, (CCC)	211	OGH500	CE, CUL, (CCC)	208
OG5126	CE, CUL, (CCC)	211	OGH501	CE, CUL, (CCC)	208
OG5127	CE, CUL, (CCC)	210	OGH502	CE, CUL, (CCC)	208
OG5128	CE, CUL, (CCC)	210	OGH504	CE, CUL, (CCC)	208
OG5129	CE, CUL, (CCC)	210	OGH580	CE, CUL, (CCC)	212
OGF080	CE, CUL	211	OGH581	CE, CUL, (CCC)	212
OGF081	CE, CUL	212	OGH700	CE, CUL, (CCC)	268
OGF100	CE, CUL, (CCC)	205	OGP080	CE, CUL	212
OGF101	CE, CUL, (CCC)	205	OGP081	CE, CUL	212
OGF102	CE, CUL, (CCC)	205	OGP100	CE, CUL, (CCC)	206
OGF103	CE, CUL, (CCC)	205	OGP101	CE, CUL, (CCC)	206
OGF200	CE, CUL, (CCC)	205	OGP102	CE, CUL, (CCC)	206
OGF201	CE, CUL, (CCC)	205	OGP103	CE, CUL, (CCC)	206
OGF280	CE, CUL, (CCC)	211	OGP200	CE, CUL, (CCC)	206
OGF281	CE, CUL, (CCC)	211	OGP201	CE, CUL, (CCC)	206
OGF282	CE, CUL, (CCC)	211	OGP280	CE, CUL, (CCC)	212
OGF300	CE, CUL, (CCC)	209	OGP281	CE, CUL, (CCC)	212
OGF301	CE, CUL, (CCC)	209	OGP282	CE, CUL, (CCC)	212

(CCC) = CCC approval is not required

Order no.	Approvals	Catalogue page	Order no.	Approvals	Catalogue page
OGP283	CE, CUL, (CCC)	212	OID251	CE, CUL	275
OGP300	CE, CUL, (CCC)	209	OID254	CE	275
OGP301	CE, CUL, (CCC)	209	OIH280	CE, CUL	214
OGP302	CE, CUL, (CCC)	209	OIH282	CE, CUL	214
OGP303	CE, CUL, (CCC)	209	OIH580	CE, CUL	214
OGP500	CE, CUL, (CCC)	208	OIH582	CE, CUL	214
OGP502	CE, CUL, (CCC)	208	OIP280	CE, CUL	214
OGP503	CE, CUL, (CCC)	208	OIP281	CE, CUL	214
OGP700	CE, CUL, (CCC)	268	OIP282	CE, CUL	214
OGP701	CE, CUL, (CCC)	268	OIP283	CE, CUL	214
OGS080	CE, CUL	211	OJ5000	CE, CUL, (CCC)	221
OGS100	CE, CUL, (CCC)	204	OJ5001	CE, CUL, (CCC)	221
OGS200	CE, CUL, (CCC)	205	OJ5004	CE, CUL, (CCC)	221
OGS280	CE, CUL, (CCC)	211	OJ5005	CE, CUL, (CCC)	221
OGS300	CE, CUL, (CCC)	209	OJ5006	CE, CUL, (CCC)	220
OGS301	CE, CUL, (CCC)	209	OJ5008	CE, CUL, (CCC)	220
OGS380	CE, CUL, (CCC)	213	OJ5009	CE, CUL, (CCC)	220
OGS500	CE, CUL, (CCC)	208	OJ5010	CE, CUL, (CCC)	220
OGS501	CE, CUL, (CCC)	207	OJ5011	CE, CUL, (CCC)	220
OGS700	CE, CUL, (CCC)	268	OJ5012	CE, CUL, (CCC)	220
OGS701	CE, CUL, (CCC)	268	OJ5014	CE, CUL, (CCC)	270
OGT100	CE, CUL, (CCC)	206	OJ5016	CE, CUL, (CCC)	270
OGT101	CE, CUL, (CCC)	206	OJ5017	CE, CUL, (CCC)	270
OGT102	CE, CUL, (CCC)	206	OJ5019	CE, CUL, (CCC)	269
OGT103	CE, CUL, (CCC)	207	OJ5020	CE, CUL, (CCC)	269
OGT200	CE, CUL, (CCC)	207	OJ5022	CE, CUL, (CCC)	219
OGT500	CE, CUL, (CCC)	208	OJ5023	CE, CUL, (CCC)	219
OH5001	CE, (CCC)	214	OJ5024	CE, CUL, (CCC)	219
OH5002	CE, (CCC)	214	OJ5026	CE, CUL, (CCC)	219
OH5003	CE, (CCC)	215	OJ5027	CE, CUL, (CCC)	219
OH5004	CE, (CCC)	215	OJ5028	CE, CUL, (CCC)	219
OH5005	CE, (CCC)	216	OJ5030	CE, CUL, (CCC)	218
OH5006	CE, (CCC)	215	OJ5031	CE, CUL, (CCC)	218
OH5007	CE, (CCC)	216	OJ5032	CE, CUL, (CCC)	218
OH5008	CE, (CCC)	215	OJ5033	CE, CUL, (CCC)	218
OH5009	CE, (CCC)	216	OJ5034	CE, CUL, (CCC)	218
OH5010	CE, (CCC)	215	OJ5036	CE, CUL, (CCC)	269
OH5011	CE, (CCC)	215	OJ5038	CE, CUL, (CCC)	268
OH5012	CE, (CCC)	215	OJ5039	CE, CUL, (CCC)	268
OH5015	CE, (CCC)	215	OJ5041	CE, CUL, (CCC)	268
OH5016	CE, (CCC)	215	OJ5042	CE, CUL, (CCC)	268
OH5017	CE, (CCC)	216	OJ5044	CE, CUL, (CCC)	221
OH5018	CE, (CCC)	215	OJ5048	CE, CUL, (CCC)	219
OH5019	CE, (CCC)	215	OJ5052	CE, CUL, (CCC)	270
OH5020	CE, (CCC)	215	OJ5054	CE, CUL, (CCC)	269
OID200	CE, CUL, (CCC)	275	OJ5056	CE, CUL, (CCC)	270
OID201	CE, CUL	275	OJ5058	CE, CUL, (CCC)	269
OID202	CE, CUL	275	OJ5060	CE, CUL, (CCC)	221
OID204	CE	276	OJ5061	CE, CUL, (CCC)	221
OID250	CE, CUL	275	OJ5062	CE, CUL, (CCC)	221

Order no.	Approvals	Catalogue page	Order no.	Approvals	Catalogue page
OJ5063	CE, CUL, (CCC)	221	OO5003	CE, CUL, (CCC)	286
OJ5065	CE, CUL, (CCC)	220	OO5004	CE, CUL, (CCC)	290
OJ5067	CE, CUL, (CCC)	220	OO5005	CE, CUL, (CCC)	290
OJ5069	CE, CUL, (CCC)	221	OO5006	CE, CUL, (CCC)	290
OJ5070	CE, CUL, (CCC)	221	OO5007	CE, CUL, (CCC)	290
OJ5071	CE, CUL, (CCC)	219	OPL200	CE, CUL, (CCC)	263
OJ5078	CE, CUL, (CCC)	219	OPL201	CE, CUL, (CCC)	263
OJ5085	CE, CUL, (CCC)	306	OPL202	CE, CUL, (CCC)	263
OJ5086	CE, CUL, (CCC)	306	OPL203	CE, CUL, (CCC)	263
OJ5100	CE, CUL, (CCC)	221	OPU200	CE, (CCC)	262
OJ5104	CE, CUL, (CCC)	221	OPU201	CE, CUL, (CCC)	262
OJ5108	CE, CUL, (CCC)	220	OPU202	CE, CUL, (CCC)	262
OJ5109	CE, CUL, (CCC)	220	OPU203	CE, CUL, (CCC)	262
OJ5114	CE, CUL, (CCC)	270	OPU204	CE, CUL, (CCC)	262
OJ5116	CE, CUL, (CCC)	270	OPU205	CE, CUL, (CCC)	262
OJ5117	CE, (CCC)	270	OPU207	CE, (CCC)	262
OJ5122	CE, CUL, (CCC)	219	OPU208	CE, CUL, (CCC)	262
OJ5126	CE, CUL, (CCC)	219	OPU209	CE, CUL, (CCC)	262
OJ5130	CE, CUL, (CCC)	219	OPU210	CE, CUL, (CCC)	262
OJ5131	CE, CUL, (CCC)	219	OPU211	CE, CUL, (CCC)	262
OJ5136	CE, CUL, (CCC)	269	OPU700	CE, CUL, (CCC)	263
OJ5138	CE, CUL, (CCC)	269	OPU701	CE, CUL, (CCC)	263
OJ5139	CE, CUL, (CCC)	269	OPU702	CE, CUL, (CCC)	263
OJ5141	CE, CUL, (CCC)	269	OU5001	CE, CUL	291
OJ5142	CE, CUL, (CCC)	269	OU5002	CE, CUL	291
OJ5144	CE, CUL, (CCC)	221	OU5043	CE, CUL	291
OJ5148	CE, CUL, (CCC)	220	OU5044	CE, CUL	291
OJ5152	CE, CUL, (CCC)	270	OY001S	CE, CUL, (CCC)	395
OJ5154	CE, CUL, (CCC)	269	OY002S	CE, CUL, (CCC)	395
OJ5158	CE, CUL, (CCC)	269	OY003S	CE, CUL, (CCC)	395
OJ5185	CE, CUL, (CCC)	306	OY004S	CE, CUL, (CCC)	395
OJ5186	CE, CUL, (CCC)	306	OY005S	CE, CUL, (CCC)	395
OJ5189	CE, CUL, (CCC)	306	OY006S	CE, CUL, (CCC)	395
OJ5190	CE, CUL, (CCC)	306	OY007S	CE, CUL, (CCC)	395
OJ5191	CE, CUL, (CCC)	306	OY008S	CE, CUL, (CCC)	395
OJE200	CE, CUL, (CCC)	218	OY009S	CE, CUL, (CCC)	395
OJH200	CE, CUL, (CCC)	218	OY010S	CE, CUL, (CCC)	395
OJP200	CE, CUL, (CCC)	218	OY011S	CE, CUL, (CCC)	395
OJR200	CE, CUL, (CCC)	218	OY031S	CE, CUL, (CCC)	402
OJS200	CE, CUL, (CCC)	218	OY032S	CE, CUL, (CCC)	402
OK5001	CE, CUL	290	OY033S	CE, CUL, (CCC)	402
OK5008	CE, CUL	290	OY034S	CE, CUL, (CCC)	402
OL0004	CCC, CE	233	OY035S	CE, CUL, (CCC)	402
OL0005	CCC, CE	233	OY036S	CE, CUL, (CCC)	402
OL0006	CE	233	OY037S	CE, CUL, (CCC)	402
OL0007	CCC, CE	233	OY038S	CE, CUL, (CCC)	402
OL0009	CCC, CE	233	OY039S	CE, CUL, (CCC)	402
OO5000	CE, CUL, (CCC)	286	OY040S	CE, CUL, (CCC)	402
OO5001	CE, CUL, (CCC)	286	OY041S	CE, CUL, (CCC)	396
OO5002	CE, CUL, (CCC)	286	OY042S	CE, CUL, (CCC)	396

(CCC) = CCC approval is not required

Order no.	Approvals	Catalogue page	Order no.	Approvals	Catalogue page
OY043S	CE, CUL, (CCC)	396	OY098S	CE, CUL, (CCC)	404
OY044S	CE, CUL, (CCC)	397	OY099S	CE, CUL, (CCC)	404
OY045S	CE, CUL, (CCC)	397	OY100S	CE, CUL, (CCC)	404
OY046S	CE, CUL, (CCC)	397	OY104S	CE, CUL, (CCC)	401
OY047S	CE, CUL, (CCC)	397	OY105S	CE, CUL, (CCC)	401
OY048S	CE, CUL, (CCC)	397	OY106S	CE, CUL, (CCC)	401
OY049S	CE, CUL, (CCC)	397	OY107S	CE, CUL, (CCC)	401
OY050S	CE, CUL, (CCC)	397	OY108S	CE, CUL, (CCC)	401
OY051S	CE, CUL, (CCC)	403	OY109S	CE, CUL, (CCC)	401
OY052S	CE, CUL, (CCC)	403	OY110S	CE, CUL, (CCC)	401
OY053S	CE, CUL, (CCC)	403	OY111S	CE, CUL, (CCC)	414
OY054S	CE, CUL, (CCC)	403	OY112S	CE, CUL, (CCC)	414
OY055S	CE, CUL, (CCC)	403	OY113S	CE, CUL, (CCC)	414
OY056S	CE, CUL, (CCC)	403	OY114S	CE, CUL, (CCC)	415
OY057S	CE, CUL, (CCC)	403	OY115S	CE, CUL, (CCC)	415
OY058S	CE, CUL, (CCC)	403	OY116S	CE, CUL, (CCC)	415
OY059S	CE, CUL, (CCC)	403	OY120S	CE, CUL, (CCC)	415
OY060S	CE, CUL, (CCC)	403	OY121S	CE, CUL, (CCC)	415
OY061S	CE, CUL, (CCC)	398	OY122S	CE, CUL, (CCC)	415
OY062S	CE, CUL, (CCC)	398	OY204S	CE, CUL, (CCC)	401
OY063S	CE, CUL, (CCC)	398	OY205S	CE, CUL, (CCC)	401
OY064S	CE, CUL, (CCC)	398	OY206S	CE, CUL, (CCC)	401
OY065S	CE, CUL, (CCC)	398	OY207S	CE, CUL, (CCC)	402
OY066S	CE, CUL, (CCC)	398	OY208S	CE, CUL, (CCC)	402
OY067S	CE, CUL, (CCC)	398	OY209S	CE, CUL, (CCC)	402
OY068S	CE, CUL, (CCC)	398	OY210S	CE, CUL, (CCC)	402
OY069S	CE, CUL, (CCC)	398	OY221S	CE, CUL, (CCC)	396
OY070S	CE, CUL, (CCC)	398	OY222S	CE, CUL, (CCC)	396
OY072S	CE, CUL, (CCC)	403	OY223S	CE, CUL, (CCC)	396
OY073S	CE, CUL, (CCC)	403	OY224S	CE, CUL, (CCC)	396
OY074S	CE, CUL, (CCC)	403	OY225S	CE, CUL, (CCC)	396
OY075S	CE, CUL, (CCC)	404	OY226S	CE, CUL, (CCC)	396
OY076S	CE, CUL, (CCC)	404	OY227S	CE, CUL, (CCC)	396
OY077S	CE, CUL, (CCC)	404	OY228S	CE, CUL, (CCC)	396
OY078S	CE, CUL, (CCC)	404	OY229S	CE, CUL, (CCC)	396
OY079S	CE, CUL, (CCC)	404	OY230S	CE, CUL, (CCC)	396
OY080S	CE, CUL, (CCC)	404	OY241S	CE, CUL, (CCC)	397
OY082S	CE, CUL, (CCC)	399	OY242S	CE, CUL, (CCC)	397
OY083S	CE, CUL, (CCC)	399	OY243S	CE, CUL, (CCC)	397
OY084S	CE, CUL, (CCC)	399	OY244S	CE, CUL, (CCC)	397
OY085S	CE, CUL, (CCC)	400	OY245S	CE, CUL, (CCC)	397
OY086S	CE, CUL, (CCC)	400	OY246S	CE, CUL, (CCC)	397
OY087S	CE, CUL, (CCC)	400	OY247S	CE, CUL, (CCC)	397
OY088S	CE, CUL, (CCC)	400	OY248S	CE, CUL, (CCC)	398
OY089S	CE, CUL, (CCC)	400	OY249S	CE, CUL, (CCC)	398
OY090S	CE, CUL, (CCC)	400	OY250S	CE, CUL, (CCC)	398
OY094S	CE, CUL, (CCC)	404	OY261S	CE, CUL, (CCC)	399
OY095S	CE, CUL, (CCC)	404	OY262S	CE, CUL, (CCC)	399
OY096S	CE, CUL, (CCC)	404	OY263S	CE, CUL, (CCC)	399
OY097S	CE, CUL, (CCC)	404	OY264S	CE, CUL, (CCC)	399

Order no.	Approvals	Catalogue page	Order no.	Approvals	Catalogue page
OY265S	CE, CUL, (CCC)	399	OY816S	CE, CUL, (CCC)	407
OY266S	CE, CUL, (CCC)	399	OY817S	CE, CUL, (CCC)	407
OY267S	CE, CUL, (CCC)	399	OY818S	CE, CUL, (CCC)	407
OY268S	CE, CUL, (CCC)	399	OY819S	CE, CUL, (CCC)	407
OY269S	CE, CUL, (CCC)	399	OY825S	CE, CUL, (CCC)	407
OY270S	CE, CUL, (CCC)	399	OY826S	CE, CUL, (CCC)	407
OY282S	CE, CUL, (CCC)	400	OY827S	CE, CUL, (CCC)	407
OY283S	CE, CUL, (CCC)	400	OY828S	CE, CUL, (CCC)	407
OY284S	CE, CUL, (CCC)	400	OY829S	CE, CUL, (CCC)	408
OY285S	CE, CUL, (CCC)	400	OY901S	CE, CUL, (CCC)	416
OY286S	CE, CUL, (CCC)	400	OY902S	CE, CUL, (CCC)	416
OY287S	CE, CUL, (CCC)	400	OY903S	CE, CUL, (CCC)	416
OY288S	CE, CUL, (CCC)	400	OY951S	CE, CUL, (CCC)	416
OY289S	CE, CUL, (CCC)	400	OY952S	CE, CUL, (CCC)	416
OY290S	CE, CUL, (CCC)	401	OY953S	CE, CUL, (CCC)	416
OY403S	CE, CUL, (CCC)	405	PA3020	CE, CUL	449
OY405S	CE, CUL, (CCC)	405	PA3021	CE, CUL	449
OY407S	CE, CUL, (CCC)	405	PA3022	CE, CUL	449
OY411S	CE, CUL, (CCC)	416	PA3023	CE, CUL	449
OY412S	CE, CUL, (CCC)	416	PA3024	CE, CUL	449
OY413S	CE, CUL, (CCC)	416	PA3026	CE, CUL	449
OY421S	CE, CUL, (CCC)	415	PA3027	CE, CUL	449
OY422S	CE, CUL, (CCC)	415	PA3028	CE, CUL	449, 514
OY423S	CE, CUL, (CCC)	415	PA3029	CE, CUL	449
OY431S	CE, CUL, (CCC)	406	PA3060	CE	448
OY432S	CE, CUL, (CCC)	406	PA3521	CE	449
OY433S	CE, CUL, (CCC)	406	PA3522	CE, CUL	449
OY434S	CE, CUL, (CCC)	406	PA3523	CE, CUL	449
OY435S	CE, CUL, (CCC)	406	PA3524	CE, CUL	449
OY436S	CE, CUL, (CCC)	406	PA3526	CE	449
OY437S	CE, CUL, (CCC)	406	PA3528	CE, CUL	449, 514
OY438S	CE, CUL, (CCC)	406	PA3589	CE, CUL	449, 514
OY439S	CE, CUL, (CCC)	406	PA9020	CE, CUL	450
OY440S	CE, CUL, (CCC)	406	PA9021	CE	450
OY441S	CE, CUL, (CCC)	405	PA9022	CE, CUL	450
OY442S	CE, CUL, (CCC)	405	PA9023	CE, CUL	450
OY443S	CE, CUL, (CCC)	405	PA9024	CE, CUL	450
OY444S	CE, CUL, (CCC)	405	PA9026	CE, CUL	450
OY445S	CE, CUL, (CCC)	405	PA9027	CE, CUL	450
OY446S	CE, CUL, (CCC)	405	PA9028	CE, CUL	450
OY447S	CE, CUL, (CCC)	405	PA9029	CE, CUL	450
OY448S	CE, CUL, (CCC)	405	PA9060	CE	450
OY449S	CE, CUL, (CCC)	405	PE3000	CE, CUL	457
OY450S	CE, CUL, (CCC)	405	PE3001	CE, CUL	457
OY804S	CE, CUL, (CCC)	406	PE3002	CE, CUL	457
OY805S	CE, CUL, (CCC)	406	PE3003	CE, CUL	457
OY806S	CE, CUL, (CCC)	406	PE3004	CE, CUL	457
OY807S	CE, CUL, (CCC)	407	PE3006	CE, CUL	458
OY808S	CE, CUL, (CCC)	407	PE3009	CE, CUL	458
OY815S	CE, CUL, (CCC)	407	PE3029	CE, CUL	458

Order no.	Approvals	Catalogue page	Order no.	Approvals	Catalogue page
PE7002	CE, CUL	457	PI2309	CE, CUL, EC19352004, EHEDG, FDA	454
PE7003	CE, CUL	457	PI2789	CE, CUL, EC19352004, EHEDG, FDA	453, 514
PE7004	CE, CUL	457	PI2793	CE, CUL, EC19352004, EHEDG, FDA	452
PE7006	CE, CUL	457	PI2794	CE, CRN, CUL, EC19352004, EHEDG, FDA	453
PE7009	CE, CUL	457	PI2795	CE, CUL, EC19352004, EHEDG, FDA	453
PF2953	CE, CUL, FDA	456	PI2796	CE, CUL, EC19352004, EHEDG, FDA	453, 515
PF2954	CE, CUL, FDA	456	PI2797	CE, CUL, EC19352004, EHEDG, FDA	453, 515
PF2956	CE, CUL, FDA	456	PI2798	CE, CUL, EC19352004, EHEDG, FDA	453, 514
PF2957	CE, CUL, FDA	456	PI2799	CE, CUL, EC19352004, EHEDG, FDA	453, 515
PG2409	CE, CUL	442	PI2889	CE, CUL, EC19352004, EHEDG, FDA	453, 515
PG2450	CE	441	PI2893	CE, CUL, EC19352004, EHEDG, FDA	453
PG2451	CE, CUL	441	PI2894	CE, CUL, EC19352004, EHEDG, FDA	453
PG2452	CE, CUL	442	PI2895	CE, CUL, EC19352004, EHEDG, FDA	453
PG2453	CE, CUL	442	PI2896	CE, CUL, EC19352004, EHEDG, FDA	453, 515
PG2454	CE, CUL, CRN	442	PI2897	CE, CUL, EC19352004, EHEDG, FDA	453, 515
PG2455	CE, CUL	442	PI2898	CE, CUL, EC19352004, EHEDG, FDA	453, 515
PG2456	CE, CUL	442	PI2899	CE, CUL, EC19352004, EHEDG, FDA	453, 515
PG2457	CE, CUL	442	PK5520	CE, CUL	442
PG2458	CE, CUL	442	PK5521	CE, CUL	442
PG2489	CE, CUL	442	PK5522	CE, CUL	442
PG2789	CE, EC19352004, EHEDG, FDA	455, 515	PK5523	CE, CUL	442
PG2793	CE, CUL, EC19352004, EHEDG, FDA	454	PK5524	CE, CUL	442
PG2794	CE, CUL, EC19352004, EHEDG, FDA	455	PK6520	CE, CUL	443
PG2795	CE, CUL, EC19352004, EHEDG, FDA	455	PK6521	CE, CUL	443
PG2796	CE, CUL, EC19352004, EHEDG, FDA	455, 515	PK6522	CE, CUL	443
PG2797	CE, CUL, EC19352004, EHEDG, FDA	455, 515	PK6523	CE, CUL	443
PG2798	CE, CUL, EC19352004, EHEDG, FDA	455, 515	PK6524	CE, CUL, CRN	443
PG2799	CE, CUL, EC19352004, EHEDG, FDA	455, 515	PK6732	CE, CUL	443
PG2889	CE, CUL, EC19352004, EHEDG, FDA	455, 516	PK6734	CE, CUL	443
PG2893	CE, CUL, EC19352004, EHEDG, FDA	455	PK7520	CE, CUL	443
PG2894	CE, CUL, EC19352004, EHEDG, FDA	455	PK7521	CE, CUL	443
PG2895	CE, CUL, EC19352004, EHEDG, FDA	455	PK7522	CE, CUL	443
PG2896	CE, CUL, EC19352004, EHEDG, FDA	455, 516	PK7523	CE, CUL	443
PG2897	CE, CUL, EC19352004, EHEDG, FDA	455, 516	PK7524	CE, CUL	443
PG2898	CE, CUL, EC19352004, EHEDG, FDA	455, 516	PK8730	CE, CUL	443
PG2899	CE, CUL, EC19352004, EHEDG, FDA	455, 516	PK8731	CE, CUL	443
PI003A	CE, EC19352004, FDA	452	PK8732	CE, CUL	443
PI008A	CE, EC19352004, FDA	452	PK8734	CE, CUL	444
PI009A	CE, EC19352004, FDA	452	PL2652	CE, CUL, EC19352004, EHEDG, FDA	456
PI2203	CE, CUL, EC19352004, EHEDG, FDA	454	PL2653	CE, CUL, EC19352004, EHEDG, FDA	456
PI2204	CE, CUL, EC19352004, EHEDG, FDA	454	PL2654	CE, CUL, EC19352004, EHEDG, FDA	456
PI2205	CE, CUL, EC19352004, EHEDG, FDA	454	PL2656	CE, CUL, EC19352004, EHEDG, FDA	456
PI2206	CE, CUL, EC19352004, EHEDG, FDA	454, 515	PL2657	CE, CUL, EC19352004, EHEDG, FDA	456
PI2207	CE, CUL, EC19352004, EHEDG, FDA	454, 515	PL2658	CE, CUL, EC19352004, EHEDG, FDA	456
PI2209	CE, CUL, EC19352004, EHEDG, FDA	454, 515	PM2653	CE, CUL, EC19352004, EHEDG, FDA	456
PI2303	CE, CUL, EC19352004, EHEDG, FDA	454	PM2654	CE, CUL, EC19352004, EHEDG, FDA	456
PI2304	CE, CUL, EC19352004, EHEDG, FDA	454	PM2655	CE, CUL, EC19352004, EHEDG, FDA	456
PI2305	CE, CUL, EC19352004, EHEDG, FDA	454	PM2656	CE, CUL, EC19352004, EHEDG, FDA	457
PI2306	CE, CUL, EC19352004, EHEDG, FDA	454	PM2657	CE, CUL, EC19352004, EHEDG, FDA	457
PI2307	CE, CUL, EC19352004, EHEDG, FDA	454	PM2658	CE, CUL, EC19352004, EHEDG, FDA	457

Order no.	Approvals	Catalogue page	Order no.	Approvals	Catalogue page
PN004A	CE	452	PN7096	CE, CUL	441
PN006A	CE	452	PN7097	CE, CUL	441
PN007A	CE	452	PN7099	CE, CUL	441
PN014A	CE	452	PN7160	CE, CUL	440
PN016A	CE	452	PN7560	CE, CUL	441
PN2070	CE	438	PN7570	CE, CUL	441
PN2071	CE	438	PN7571	CE, CUL	441
PN2092	CE	438	PN7592	CE, CUL	441
PN2093	CE	438	PN7593	CE, CUL	441
PN2094	CE	438	PN7594	CE, CUL	441
PN2096	CE	438	PN7596	CE, CUL	441
PN2097	CE	438	PN7597	CE, CUL	441
PN2098	CE	438	PN7599	CE, CUL	441
PN2099	CE	438	PN7809	CE, CUL	445
PN2160	CE	438	PN7834	CE, CUL	445
PN2169	CE	438	PP000E	CE, E1R	727
PN2560	CE	438	PP001E	CE, E1R	727
PN2569	CE	439	PP002E	CE, E1R	727
PN2570	CE	438	PP003E	CE, E1R	727
PN2571	CE	438	PP004E	CE, E1R	727
PN2592	CE	438	PP0520	CE	444
PN2593	CE	438	PP0521	CE	444
PN2594	CE	439	PP0522	CE, CUL	444
PN2596	CE	439	PP0523	CE, CUL	444
PN2597	CE	439	PP0524	CE, CUL	444
PN2598	CE	439	PP2001	CE, CUL	458, 728
PN2599	CE	439	PP7550	CE	444
PN3070	CE, CUL	439	PP7551	CE	444
PN3071	CE, CUL	439	PP7552	CE, CUL	444
PN3092	CE, CUL	439	PP7553	CE, CUL	444
PN3093	CE, CUL	439	PP7554	CE, CUL	444
PN3094	CE, CUL	439	PP7556	CE, CUL	444
PN3096	CE, CUL	439	PQ0809	CE, CUL	445
PN3097	CE, CUL	439	PQ0834	CE, CUL	445
PN3129	CE, CUL	439	PQ3809	CE, CUL	445
PN3160	CE, CUL	439	PQ3834	CE, CUL	445
PN3529	CE, CUL	440	PQ7809	CE, CUL	445
PN3560	CE, CUL	439	PQ7834	CE, CUL	445
PN3570	CE, CUL	440	PS307A	CE, GL, IEC	451, 514
PN3571	CE, CUL	440	PS308A	CE, GL, IEC	451, 514
PN3592	CE, CUL	440	PS317A	CE, GL, IEC	451, 514
PN3593	CE, CUL	440	PS3208	CE	450, 513
PN3594	CE, CUL	440	PS3407	CE	451, 513
PN3596	CE, CUL	440	PS3417	CE	451, 513
PN3597	CE, CUL	440	PS3427	CE	451, 513
PN7070	CE, CUL	440	PS3607	CE	451, 513
PN7071	CE, CUL	440	PS3617	CE	451, 513
PN7092	CE, CUL	440	PS4208	CE	451, 513
PN7093	CE, CUL	440	PS4407	CE	451, 513
PN7094	CE, CUL	440	PS4417	CE	451, 514

Order no.	Approvals	Catalogue page	Order no.	Approvals	Catalogue page
PS7570	CE	450	PU5604	CE	448, 725
PT3550	CE, CUL	447, 727	PU5660	CE	448, 725
PT3551	CE, CUL	447, 727	PU5700	CE	448, 726
PT3552	CE, CUL	447, 727	PU5701	CE	448, 726
PT3553	CE, CUL	447, 727	PU5702	CE	448, 726
PT3554	CE, CUL	447, 727	PU5703	CE	448, 726
PT3560	CE	727	PU5704	CE	448, 726
PT5400	CE, CUL	445	PU5760	CE	448, 726
PT5401	CE, CUL	445	QA0001		160, 238
PT5402	CE, CUL	446	RA3100	CE	334
PT5403	CE, CUL	446	RA3500	CE	334
PT5404	CE, CUL	446	RB3100	CE	334
PT5412	CE, CUL	446	RB3500	CE	334
PT5414	CE, CUL	446	RM3006	CE, PI	336
PT5415	CE, CUL	446	RM3007	CE, PI	336
PT5423	CE, CUL	446	RM3008	CE, PI	336
PT5443	CE, CUL	446	RM3010	CE, Profinet	336
PT5460	CE, CUL	445	RM3011	CE	336
PT5600	CE	726	RM7011	CE	337
PT5601	CE	726	RM7012	CE	337
PT5602	CE	726	RM8001	CE	335
PT5603	CE	726	RM8002	CE	335
PT5604	CE	726	RM8003	CE	335
PT5660	CE	726	RM9000	CE, E1, (CCC)	720
PT5700	CE	726	RN3001	CE, PI	336
PT5701	CE	726	RN7011	CE	336
PT5702	CE	726	RN7012	CE	337
PT5703	CE	727	RO3100	CE	335
PT5704	CE	727	RO3500	CE	335
PT5760	CE	727	ROP520	CE	335
PT9550	CE, CUL	447, 727	RU3100	CE	334
PT9551	CE, CUL	447, 728	RU3500	CE	334
PT9552	CE, CUL	447, 728	RUP500	CE	335
PT9553	CE, CUL	447, 728	RV3100	CE	334
PT9554	CE, CUL	447, 728	RV3500	CE	334
PU5400	CE, CUL	446	RVP510	CE	335
PU5401	CE, CUL	446	SA4100	CE	479
PU5402	CE, CUL	446	SA4300	CE	479
PU5403	CE, CUL	446	SA5000	CE	479
PU5404	CE, CUL	447	SBG232	CE	482
PU5412	CE, CUL	446	SBG233	CE	482
PU5414	CE, CUL	447	SBG234	CE	482
PU5415	CE, CUL	447	SBG246	CE	482
PU5423	CE, CUL	446	SBG257	CE	482
PU5443	CE, CUL	446	SBG332	CE	483
PU5460	CE, CUL	446	SBG333	CE	483
PU5600	CE	448, 725	SBG334	CE	483
PU5601	CE	448, 725	SBG346	CE	483
PU5602	CE	448, 725	SBG357	CE	483
PU5603	CE	448, 725	SBM613	CE	484

Order no.	Approvals	Catalogue page	Order no.	Approvals	Catalogue page
SBT633	CE	483	SF5300	CUL	484
SBT634	CE	483	SF5350	CUL	484
SBU323	CE, CUL	481	SF5700	CUL	484
SBU324	CE, CUL	481	SF5701	CUL	485
SBU623	CE, CUL	481	SF5702	CUL	485
SBU624	CE, CUL	481	SF5703	CUL	485
SBU625	CE, CUL	481	SF5704	CUL	485
SBY232	CE	481	SF5800	CUL	484
SBY233	CE	482	SF6200	CUL	484
SBY234	CE	482	SF6201	CUL	484
SBY246	CE	482	SF620A	CE, IEC	486
SBY257	CE	482	SI0521	CE, GL	480
SBY323	CE	482	SI0553	CE	479
SBY332	CE, CUL	482	SI5000	CE, CUL	478
SBY333	CE, CUL	482	SI5002	CE, CUL	478
SBY334	CE, CUL	482	SI5004	CE, CUL, CRN	479
SBY346	CE, CUL	483	SI5006	CE, CUL, CRN	479
SBY357	CE, CUL	483	SI5007	CE, CUL	480
SBY433	CE, CUL	483	SI500A	CE	480
SBY434	CE, CUL	483	SI5010	CE, CRN, CUL	479
SBY446	CE, CUL	483	SI5100	CE	480
SBY457	CE, CUL	483	SI6600	CE, CUL, EHEDG, FDA, CRN, EC19352004	481
SD0523	CE, CUL, CRN	488, 670	SI6700	CE, CUL, EHEDG, FDA, EC19352004	481
SD2000	CE, CUL	488, 670	SI6800	CE, CUL, EHEDG, FDA, CRN, EC19352004	481
SD5000	CE, CUL	488, 670	SL0101	CE	487
SD5100	CE, CUL	488	SL0201	CE	487
SD6000	CE, CRN, CUL	488, 670	SL5101	CE	487
SD6050	CE, CUL	488, 670	SM0510	CE, CUL	477
SD6100	CE, CUL	488	SM2000	CE, CUL	477
SD8000	CE, CUL	488, 670	SM2004	CE, CUL	477
SD9000	CE, CUL	488, 670	SM2100	CE, CUL, KTW	477, 672
SF0516	CUL	485	SM6000	CE, CUL	476
SF0540		486	SM6004	CE, CUL	477
SF111A	CE, IEC	486	SM6050	CE, CUL	478
SF120A	CE, IEC	486	SM6100	CE, CUL, KTW	477, 672
SF121A	CE, IEC	486	SM7000	CE, CUL	476
SF211A	CE, IEC	486	SM7004	CE, CUL	477
SF220A	CE, IEC	486	SM7050	CE, CUL	478
SF221A	CE, IEC	486	SM7100	CE, CUL, KTW	477, 672
SF223A	CE, IEC	487	SM8000	CE, CUL	476
SF2405	CUL	485	SM8004	CE, CUL	477
SF2410	CUL	485	SM8050	CE, CUL	478
SF311A	CE, IEC	486	SM8100	CE, CUL, KTW	478, 672
SF320A	CE, IEC	486	SM9000	CE, CUL	477
SF321A	CE, IEC	486	SM9004	CE, CUL	477
SF323A	CE, IEC	487	SM9100	CE, CUL, KTW	478, 672
SF3405		485	SN0150	CE, CUL	566
SF3410		485	SN0151	CE, CUL	566
SF5200	CUL	484	SN2301	CE, IEC	566
SF5201	CUL	484	SN2302	CE, IEC	566

Order no.	Approvals	Catalogue page	Order no.	Approvals	Catalogue page
SP321A	CE, IEC	487	TA2405	CE, CUL	538
SR0150	CE, CUL	566	TA2415	CE, CUL	538
SR0153	CE, CUL	566	TA2417	CE, CUL	538
SR2301	CE, IEC	567	TA2435	CE, CUL	538
SR307A	CE, IEC	567	TA2437	CE, CUL	538
SR5900	CE, CUL	566	TA2445	CE, CUL	538
SR5906	CE, CUL	566	TA2447	CE, CUL	538
SU7000	CE, CUL	489, 673	TA2502	CE, CUL, EC19352004, EHEDG, FDA	541
SU7200	CE, CUL	489, 673	TA2512	CE, CUL, EC19352004, EHEDG, FDA	541
SU8000	CE, CUL	489, 673	TA2532	CE, CUL, EC19352004, EHEDG, FDA	541
SU8200	CE, CUL	489, 673	TA2542	CE, CUL, EC19352004, EHEDG, FDA	541
SU9000	CE, CUL	489, 673	TA2603	CE, CUL	539
SU9004	CE, CUL	489, 673	TA2613	CE, CUL	539
SV3050	CE	475	TA2633	CE, CUL	539
SV3150	CE	475	TA2643	CE, CUL	539
SV4050	CE	476	TA2802	CE, CUL, EC19352004, EHEDG, FDA	541
SV4150	CE	476	TA2812	CE, CUL, EC19352004, EHEDG, FDA	541
SV4200	CE, CUL	475	TA2832	CE, CUL, EC19352004, EHEDG, FDA	541
SV4204	CE, CUL	475	TA2842	CE, CUL, EC19352004, EHEDG, FDA	541
SV4500	CE, CUL	475	TA3597	CE, EC19352004, FDA	541
SV4504	CE, CUL	475	TAA131	CE, CUL	618
SV5050	CE	476	TAA431	CE, CUL, EC19352004, EHEDG, FDA	618
SV5150	CE	476	TAD081	CE, CUL, EC19352004, EHEDG, FDA	542
SV5200	CE, CUL	475	TAD091	CE, CUL, EC19352004, EHEDG, FDA	542
SV5204	CE, CUL	475	TAD181	CE, CUL, EC19352004, EHEDG, FDA	542
SV5500	CE, CUL	475	TAD191	CE, CUL, EC19352004, EHEDG, FDA	542
SV5504	CE, CUL	475	TAD981	CE, CUL, EC19352004, EHEDG, FDA	542
SV6050	CE	476	TAD991	CE, CUL, EC19352004, EHEDG, FDA	542
SV6150	CE	476	TD2211	CE, CUL, EC19352004, FDA	544
SV7050	CE	476	TD2217	CE, CUL, EC19352004, FDA	544
SV7150	CE	476	TD2231	CE, CUL, EC19352004, FDA	544
SV7200	CE, CUL	475	TD2237	CE, CUL, EC19352004, FDA	544
SV7204	CE, CUL	475	TD2241	CE, CUL, EC19352004, FDA	544
SV7500	CE, CUL	475	TD2247	CE, CUL, EC19352004, FDA	544
SV7504	CE, CUL	475	TD2251	CE, CUL, EC19352004, FDA	544
SV8050	CE	476	TD2253	CE, CUL, EC19352004, FDA	545
SV8150	CE	476	TD2257	CE, CUL, EC19352004, FDA	545
TA2002	CE, CUL, EC19352004, FDA	540	TD2261	CE, CUL, EC19352004, FDA	544
TA2012	CE, CUL, EC19352004, FDA	540	TD2267	CE, CUL, EC19352004, FDA	544
TA2105	CE, CUL	538	TD2271	CE, CUL, EC19352004, FDA	545
TA2115	CE, CUL	538	TD2273	CE, CUL, EC19352004, FDA	545
TA2135	CE, CUL	538	TD2277	CE, CUL, EC19352004, FDA	545
TA2145	CE, CUL	538	TD2291	CE, CUL, EC19352004, FDA	545
TA2212	CE, CUL, EC19352004, FDA	541	TD2293	CE, CUL, EC19352004, FDA	545
TA2232	CE, CUL, EC19352004, FDA	541	TD2297	CE, CUL, EC19352004, FDA	545
TA2242	CE, CUL, EC19352004, FDA	541	TD2501	CE, CUL, EC19352004, EHEDG, FDA	542
TA2303	CE, CUL	538	TD2507	CE, CUL, EC19352004, EHEDG, FDA	542
TA2313	CE, CUL	538	TD2511	CE, CUL, EC19352004, EHEDG, FDA	542
TA2333	CE, CUL	538	TD2517	CE, CUL, EC19352004, EHEDG, FDA	542
TA2343	CE, CUL	538	TD2531	CE, CUL, EC19352004, EHEDG, FDA	542

Order no.	Approvals	Catalogue page	Order no.	Approvals	Catalogue page
TD2537	CE, CUL, EC19352004, EHEDG, FDA	542	TM5411	CUL	535
TD2541	CE, CUL, EC19352004, EHEDG, FDA	543	TM9900	CUL	535
TD2547	CE, CUL, EC19352004, EHEDG, FDA	542	TM9950	CUL	534
TD2801	CE, CUL, EC19352004, EHEDG, FDA	543	TN2511	CE	532
TD2803	CE, CUL, EC19352004, EHEDG, FDA	543	TN7511	CE	532
TD2807	CE, CUL, EC19352004, EHEDG, FDA	543	TP3231	CE, CUL	533
TD2811	CE, CUL, EC19352004, EHEDG, FDA	543	TP3232	CE, CUL	533
TD2813	CE, CUL, EC19352004, EHEDG, FDA	543	TP3233	CE, CUL	533
TD2817	CE, CUL, EC19352004, EHEDG, FDA	543	TP3237	CE, CUL	533
TD2831	CE, CUL, EC19352004, EHEDG, FDA	543	TP9237	CE, CUL	533
TD2833	CE, CUL, EC19352004, EHEDG, FDA	543	TR2439	CE	533
TD2837	CE, CUL, EC19352004, EHEDG, FDA	543	TR7439	CE	533
TD2841	CE, CUL, EC19352004, EHEDG, FDA	543	TR8430	CE, CUL	532
TD2843	CE, CUL, EC19352004, EHEDG, FDA	543	TS0759		536
TD2847	CE, CUL, EC19352004, EHEDG, FDA	543	TS2056		536
TD2901	CE, CUL, EC19352004, EHEDG, FDA	544	TS2089		536
TD2903	CE, CUL, EC19352004, EHEDG, FDA	544	TS2229		537
TD2907	CE, CUL, EC19352004, EHEDG, FDA	543	TS2239		537
TD2911	CE, CUL, EC19352004, EHEDG, FDA	544	TS2256		536
TD2913	CE, CUL, EC19352004, EHEDG, FDA	544	TS2289		536
TD2917	CE, CUL, EC19352004, EHEDG, FDA	543	TS2659		536
TD2931	CE, CUL, EC19352004, EHEDG, FDA	544	TS2689	CE	536
TD2933	CE, CUL, EC19352004, EHEDG, FDA	544	TS2759		536
TD2937	CE, CUL, EC19352004, EHEDG, FDA	543	TS2789		536
TD2941	CE, CUL, EC19352004, EHEDG, FDA	544	TS285A	CE	537
TD2943	CE, CUL, EC19352004, EHEDG, FDA	544	TS325A	CE	537
TD2947	CE, CUL, EC19352004, EHEDG, FDA	543	TS4759		535
TK6130	CE, CUL	532	TS502A	CE	537
TK7130	CE, CUL	532	TS5089		536
TK7480	CE, CUL	532	TS522A	CE	537
TM4101	CUL	535	TS5289		536
TM4411	CUL	535	TS9256		535
TM4431	CUL	535	TS9289		536
TM4441	CUL	535	TT0281	CUL, EC19352004	534
TM4461	CUL	535	TT0291	CUL, EC19352004, FDA	539
TM4501	CUL, EC19352004, EHEDG, FDA	540	TT1050	CUL	533
TM4511	CUL, EC19352004, EHEDG, FDA	540	TT1081	CUL	534
TM4531	CUL, EC19352004, EHEDG, FDA	540	TT1281	CUL, EC19352004	534
TM4541	CUL, EC19352004, EHEDG, FDA	540	TT1291	CUL, EC19352004, FDA	539
TM4591	CUL, EC19352004, EHEDG, FDA	540	TT2050	CUL	533
TM4599	FDA	540	TT2081	CUL	534
TM4801	CUL, EC19352004, EHEDG, FDA	539	TT2281	CUL, EC19352004	534
TM4811	CUL, EC19352004, EHEDG, FDA	539	TT2291	CUL, EC19352004, FDA	539
TM4831	CUL, EC19352004, EHEDG, FDA	540	TT3050	CUL	534
TM4841	CUL, EC19352004, EHEDG, FDA	540	TT3081	CUL	534
TM4901	CUL, EC19352004, EHEDG, FDA	540	TT3281	CUL, EC19352004	534
TM4911	CUL, EC19352004, EHEDG, FDA	540	TT3291	CUL, EC19352004, FDA	539
TM4931	CUL, EC19352004, EHEDG, FDA	540	TT5050	CUL	534
TM4941	CUL, EC19352004, EHEDG, FDA	540	TT5081	CUL	534
TM5101	CUL	535	TT6281	CUL	534

Order no.	Approvals	Catalogue page
TT7281	CUL, EC19352004	534
TT9281	CUL, EC19352004	534
TT9291	CUL, EC19352004, FDA	539
TW2000	CE	545
TW2001	CE	545
TW2002	CE	545
TW2011	CE	545
TW7000	CE	545
TW7001	CE	546
TW7011	CE	546
VES004		666
VKV021	CE, CUL	664
VKV022	CE, CUL	664
VNB001	CE, CUL	665
VOS001		666
VOS002		666
VOS003		666
VOS004		666
VOS005		666
VSA001	CE, CUL	667
VSA002	CE, CUL	667
VSA004	CE, CUL	667
VSA005	CE, CUL	667
VSA006	CE, CUL	667
VSA101	CE, CUL	667
VSA201	CE, CUL	667
VSE002	CE, CUL	666
VSE100	CE, CUL	666
VSP001	CE	667
VSP01A	CE	667
VSP02A	CE	667
VTV121	CE, CUL	665
VTV122	CE, CUL	665
VTV12A	CE	665
ZC0004		459, 518
ZC0005		460, 518
ZC0013		547
ZC0014		547
ZC0015		548
ZC0016		548
ZC0017		548
ZC0018		548
ZC0061		548
ZZ0214	CE, (CCC)	317, 576



AS-Interface

AS-Interface (actuator sensor interface) is a worldwide manufacturer-independent standard for the connection of actuators and sensors of the first field level. Data and power supply are jointly transmitted via a two-wire cable. Wiring complexity, documentation and set-up times are reduced.

ATEX

ATEX (Atmosphère explosible) is a brief description of the uniform EU directives 94/9/EC (for manufactures of units for hazardous areas) and 1999/92/EC (for operators of plants for hazardous areas) governing the safety requirements for explosion-hazardous areas. Since 30 June 2003, units for hazardous areas have to be approved to 94/9/EU regulations. For further information about international directives see the "Approvals" chapter.

E1 type approval









The E1 type approval by the German Federal Motor Transport Authority certifies that the units comply with the automotive standards.







IO-Link

IO-Link is a field-bus independent and open point-to-point communication interface. It is a low-cost possibility to transmit parameter, diagnosis and process data from a sensor or an actuator via an I/O module.

Safety

The EC Machinery Directive stipulates machinery should not present a risk. If safety is dependent on control systems, these must be designed so as to minimise malfunction. The IEC 62061 und ISO 13849-1 standards apply. Classification is made either in the Safety Integrity Level (SIL 1-3 in IEC 62061) or in the Performance Level (PL a-e in ISO 13849-1).

<i>AS-i sensors</i>		<i>Page</i>
	AS-i sensors	618 - 619
	Valve sensors	315 - 315 318 - 318 573 - 573 576 - 576 622 - 623
<i>Sensors for hazardous areas (ATEX)</i>		<i>Page</i>
	Inductive sensors	114 - 119
	Capacitive sensors	156 - 157
	Cylinder sensor	187 - 187
	Valve sensors	316 - 317 574 - 575 622 - 622
	Photoelectric sensors	232 - 232 276 - 276
	Flow sensors	480 - 480 486 - 487

Sensors for hazardous areas (ATEX)		Page
	Pressure sensors	451 - 452 514 - 514
	Temperature sensors	537 - 537
	Diagnostic systems	665
Sensors with E1 approval		Page
	Inductive sensors	722 - 724
	Pressure sensors	725 - 728
Sensors with IO-Link		Page
	Capacitive sensors	155 - 156
	Pressure sensors	444

<i>Sensors with IO-Link</i>		<i>Page</i>
-----------------------------	--	-------------

	Temperature sensors	532 - 533 542 - 542
---	---------------------	------------------------

<i>Sensors for safety technology</i>		<i>Page</i>
--------------------------------------	--	-------------

	Inductive sensors	390 - 391
---	-------------------	-----------

	Safety light curtains	395 - 396 398 - 404 406 - 407
---	-----------------------	-------------------------------------

	Safety light grid	414 - 416
---	-------------------	-----------

Well positioned



Position detection in the food industry.



Different measurement techniques

ifm offers a wide range of position sensors. Inductive, capacitive and magnetic sensors detect targets or objects in the range of a few millimetres up to several centimetres. For greater distances there are photoelectric sensors with ranges up to tens of metres. Moreover special types such as optical fork and angle sensors, fibre optics, colour and contrast sensors or cylinder sensors are used for position detection in special applications. ifm also offers suitable solutions for the detection of valve positions. All sensors are fully electronic, i.e. they work without mechanical components. The advantage: they are wear-free and provide high switching frequencies.

Microprocessor technology makes it possible

The applied microprocessor technology allows fast and easy switch point setting via pushbuttons. Clearly visible LEDs indicate the switching status. In addition to the 3-wire output stage, many position sensors can also be supplied in a 2-wire version. ifm also offers sensors with a built-in AS-Interface (AS-i).

Special applications

Sensors are used in many different areas. These include machine and plant construction as well as applications in factory automation and process technology. Special solutions are for example provided for food applications or mobile machines.

Besides constructional measures such as high-quality housing materials and coatings, the sensors also comply with applicable approvals (e.g. ATEX or E1). Regular and thorough testing in production to the highest standards combined with equally high standards at the development stage ensure a consistently high quality.

	<i>Inductive sensors</i>	64 - 149
	<i>Capacitive sensors</i>	150 - 168
	<i>Magnetic sensors</i>	170 - 178
	<i>Cylinder sensors</i>	180 - 199
	<i>Photoelectric sensors for general applications</i>	200 - 258
	<i>Photoelectric fork sensors / angle sensors</i>	260 - 265
	<i>Laser sensors / distance measurement sensors</i>	266 - 283
	<i>Fibre optic sensors</i>	284 - 302
	<i>Photoelectric sensors for specific applications</i>	304 - 311
	<i>Feedback systems for valves and valve actuators</i>	312 - 325
	<i>Switching amplifiers</i>	326 - 328



- Extensive range of inductive sensors for industrial environments
- High-quality housing materials
- Connector, cabled and wirable versions
- Wide selection of fixing accessories and connectors

Inductive sensors

Inductive proximity sensors are used for input signals detecting machine parts in most automated processes. They supply the necessary signals for positions and limits, or serve as pulse pick-ups for counting tasks or for monitoring rotational speed. Inductive sensors offer ideal characteristics compared to mechanical switches: non-contact operation free from any wear and tear, high switching frequencies and accuracy. In addition, they are insensitive to vibration, dust and moisture. Inductive sensors detect all metals without contact.

Operating principles used in inductive sensors

Inductive sensors operate on more than one physical principle; the standard sensor contains a coil which is used to propagate a very low energy oscillating electromagnetic field. If a conductive material – for practical purposes a metal – enters this field, then eddy currents will be induced in the surface of the material which in turn draw energy from the oscillator. This reduces the oscillation amplitude and the change is converted into a switching signal. This operating principle permits detection of all metals irrespective of whether they are moving or not, but different metals will result in different sensing distances. If the sensor is designed to detect metals without this correction factor, the two oscillating fields are generated and the phase shift caused by a metal presence is evaluated.

Application sensors

Every application places different and often conflicting demands on the sensors used in different environments. Temperature shocks, mechanical influences or aggressive cleaning agents, oils and coolants are just a few of the possible environmental influences to which sensors are subjected. ifm therefore offers inductive sensors which have been developed for specific applications. This includes, for example, the use of selected housing materials such as stainless steel, LCP, PEEK, PBT or ceramics. An innovative sealing concept from the sensor to the connector ensures ideal protection against ingress of moisture and aggressive media.



Typical application: Positioning sensing in automation technology; inductive sensors operate reliably and without wear.

High frequency electromagnetic field: The inductive sensor detects all metals.

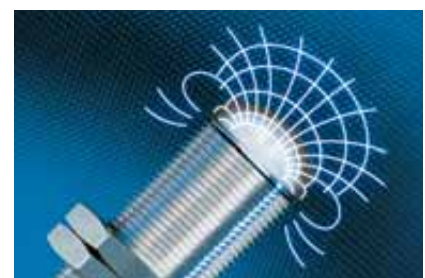





System overview	Page
Sensors for industrial applications with increased sensing range	67 - 70
Sensors for industrial applications, threaded housings	70 - 76
Sensors for industrial applications with smooth sleeve	76 - 78
Sensors for industrial applications, rectangular housings	78 - 82
Sensors for industrial applications, AC and AC/DC	83 - 85
Sensors for industrial applications with analogue output 4...20 mA	85 - 86
Sensors for industrial applications with analogue output 0...10 V	86
Sensors for industrial high temperature applications	87
Sensors for industrial applications on pipes and tubes	87 - 88
Tube sensors for industrial applications	88 - 89
Sensors for industrial applications, oils and coolants and mobile applications with increased sensing range	89 - 95
Sensors for oils and coolants with increased sensing range	95 - 98
Sensors for oils and coolants, threaded housings	99 - 100
Sensors for oils and coolants, rectangular housings	100
Sensors for oils and coolants with correction factor K = 1	101
Sensors for oils and coolants with ceramic sensing face	101 - 102
Sensors for oils and coolants, AS-i system	102
Electromagnetic field immune sensors with correction factor K = 1	103 - 104
Electromagnetic field immune sensors	104
Full metal sensors for oils and coolants	105
Full metal sensors for oils and coolants with correction factor K = 0	106
Full metal sensors with non-stick coating against weld spatter	106 - 108
Full metal sensors for hygienic and wet areas	108 - 109
Sensors for hygienic and wet areas with increased sensing range	109 - 112
Sensors for hygienic and wet areas	112 - 114
Sensors with ATEX approval 1D / 2G	114 - 115
Sensors with ATEX approval 1D / 1G / 2G	115 - 116
Sensors with ATEX approval 3D/3G	116 - 117
Sensors with ATEX approval 3D	117 - 118
Sensors with ATEX approval 2D / 3G	119
Slot sensors with ATEX approval 1D/1G	119
Switching amplifiers with ATEX approval	119 - 120

System overview	Page
Accessories for sensors with smooth sleeve	120
Accessories for threaded M8 housings	121
Accessories for threaded M12 housings	121 - 122
Accessories for threaded M18 housings	122 - 123
Accessories for threaded M30 housings	123
Accessories for rectangular housings	123
System components	124 - 125
Wiring diagrams	125 - 128
Scale drawings / drawing no. – CAD download: www.ifm.com	128 - 149







Sensors for industrial applications with increased sensing range

Type	Dimensions [mm]	Sensing range [mm]	Material	U _b [V]	Protection	f [Hz]	I _{load} [mA]	Draw- ing no.	Order no.
------	--------------------	--------------------------	----------	-----------------------	------------	-----------	---------------------------	---------------------	--------------



M12 connector · Output function  · 2-wire · DC PNP/NPN · Wiring diagram no. 37 · Connector groups 8, 10, 11, 18, 20

	M12 / L = 45	4 f	Brass	10...30	IP 67	700	100	1	IFS200
	M12 / L = 50	7 nf	Brass	10...30	IP 67	700	100	2	IFS201
	M18 / L = 46	8 f	Brass	10...30	IP 67	300	100	3	IGS200
	M18 / L = 51	12 nf	Brass	10...30	IP 67	250	100	4	IGS201

M12 connector · Output function  · 3-wire DC PNP · 2-wire DC PNP/NPN · Wiring diagram no. 38 · Connector groups 8, 10, 11, 18, 20

	M12 / L = 70	4 f	Brass	10...30	IP 67	500	100	5	IFS208
	M12 / L = 70	7 nf	Brass	10...30	IP 67	500	100	6	IFS209
	M18 / L = 70	8 f	Brass	10...30	IP 67	400	100	7	IGS208
	M18 / L = 70	12 nf	Brass	10...30	IP 67	300	100	8	IGS209
	M30 / L = 70	15 f	Brass	10...36	IP 67	100	100	9	IIS206
	M30 / L = 70	22 nf	Brass	10...36	IP 67	100	100	10	IIS207

M12 connector · Output function  · 3-wire · DC PNP · Wiring diagram no. 1 · Connector groups 8, 10, 18, 20

	M12 / L = 45	4 f	Brass	10...30	IP 67	700	100	11	IFS204
	M12 / L = 50	7 nf	Brass	10...30	IP 67	700	100	12	IFS205

M12 connector · Output function  · 3-wire · DC PNP · Wiring diagram no. 1 · Connector groups 8, 10, 18, 20, 120, 124, 126, 128, 157

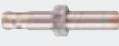
	M12 / L = 70	4 f	Brass	10...30	IP 67	700	100	13	IFS212
---	--------------	-----	-------	---------	-------	-----	-----	----	--------

Position sensors



Type	Dimensions [mm]	Sensing range [mm]	Material	U _b [V]	Protection	f [Hz]	I _{load} [mA]	Drawing no.	Order no.
M12 connector · Output function  · 3-wire · DC PNP · Wiring diagram no. 1 · Connector groups 8, 10, 18, 20, 120, 124, 126, 128, 157									
	M12 / L = 70	7 nf	Brass	10...30	IP 67	700	100	14	IFS213
	M18 / L = 45	8 f	Brass	10...30	IP 67	400	100	15	IGS204
	M18 / L = 50	12 nf	Brass	10...30	IP 67	300	100	16	IGS205
M12 connector · Output function  · 3-wire · DC PNP · Wiring diagram no. 1 · Connector groups 8, 10, 11, 18, 20									
	M18 / L = 70	8 f	Brass	10...36	IP 67	400	100	7	IGS212
	M18 / L = 70	12 nf	Brass	10...36	IP 67	300	100	8	IGS213
M12 connector · Output function  · 3-wire · DC PNP · Wiring diagram no. 1 · Connector groups 8, 10, 18, 20, 157									
	M30 / L = 50	15 f	Brass	10...30	IP 67	100	100	17	IIS204
	M30 / L = 50	22 nf	Brass	10...30	IP 67	100	100	18	IIS205
M12 connector · Output function  · 3-wire · DC PNP · Wiring diagram no. 1 · Connector groups 8, 10, 11, 18, 20									
	M30 / L = 70	15 f	High-grade st. steel	10...36	IP 67	100	100	9	IIS210
	M30 / L = 70	22 nf	High-grade st. steel	10...36	IP 67	100	100	10	IIS211
M12 connector · Output function  · 3-wire · DC PNP · Wiring diagram no. 2 · Connector groups 8, 10, 18, 20									
	M12 / L = 45	4 f	Brass	10...30	IP 67	700	100	11	IFS206
	M12 / L = 50	7 nf	Brass	10...30	IP 67	700	100	12	IFS207
M12 connector · Output function  · 3-wire · DC PNP · Wiring diagram no. 2									
	M18 / L = 45	8 f	Brass	10...30	IP 67	400	100	15	IGS206

Type	Dimensions [mm]	Sensing range [mm]	Material	U _b [V]	Protection	f [Hz]	I _{load} [mA]	Drawing no.	Order no.
M12 connector · Output function  · 3-wire · DC PNP · Wiring diagram no. 2 · Connector groups 8, 10, 18, 20, 120, 124, 126, 128, 157									
	M18 / L = 50	12 nf	Brass	10...30	IP 67	300	100	16	IGS207
M12 connector · Output function  · 3-wire · DC PNP · Wiring diagram no. 2 · Connector groups 8, 10, 18, 20, 157									
	M30 / L = 50	15 f	Brass	10...30	IP 67	100	100	17	IIS208
	M30 / L = 50	22 nf	Brass	10...30	IP 67	100	100	18	IIS209
M12 connector · Output function  /  · 2-wire · DC PNP/NPN · Wiring diagram no. 39 · Connector groups 8, 10, 18, 20									
	M18 / L = 70	8 f	Brass	10...36	IP 68	400	100	19	IGS953
	M18 / L = 72	12 nf	Brass	10...36	IP 68	250	100	20	IGS954
M8 connector · Output function  · 3-wire · DC PNP · Wiring diagram no. 1 · Connector groups 1, 2, 3									
	M12 / L = 46	4 f	Brass	10...36	IP 67	700	100	21	IFS210
	M12 / L = 51	7 nf	Brass	10...36	IP 67	700	100	22	IFS211
	M18 / L = 46	8 f	Brass	10...36	IP 67	400	100	23	IGS210
Cable 2 m · Output function  · 2-wire · AC · Wiring diagram no. 3									
	Ø 100	70 nf	PBT	90...250	IP 65	5	200	24	I12001*
	Ø 100	70 nf	PBT	90...250	IP 65	5	200	25	I12003*
	Ø 164	120 nf	PBT	90...250	IP 65	3	200	26	I22001*
	Ø 164	120 nf	PBT	90...250	IP 65	3	200	27	I22003*

Position sensors

Type	Dimensions [mm]	Sensing range [mm]	Material	U _b [V]	Protection	f [Hz]	I _{load} [mA]	Drawing no.	Order no.
------	--------------------	-----------------------	----------	-----------------------	------------	-----------	---------------------------	-------------	-----------

Cable 2 m · Output function · 3-wire · DC PNP · Wiring diagram no. 4

	Ø 100	70 nf	PBT	10...36	IP 65	5	250	24	I17001
	Ø 100	70 nf	PBT	10...36	IP 65	5	250	25	I17003
	Ø 164	120 nf	PBT	10...36	IP 65	3	250	26	I27001

7/8" connector · Output function · 2-wire · AC · Wiring diagram no. 5 · Connector groups 31, 32

	Ø 164	120 nf	PBT	90...250	IP 65	3	200	28	I22006*
---	-------	--------	-----	----------	-------	---	-----	----	---------

f = flush / nf = non flush



* Note for AC and AC/DC units

Miniature fuse to IEC60127-2 sheet 1, ≤ 2 A (fast acting) Recommendation: check the unit for reliable function after a short circuit.

Sensors for industrial applications, threaded housings

Type	Dimensions [mm]	Sensing range [mm]	Material	U _b [V]	Protection	f [Hz]	I _{load} [mA]	Drawing no.	Order no.
------	--------------------	-----------------------	----------	-----------------------	------------	-----------	---------------------------	-------------	-----------

Cable 0.3 m · with M12 connector · Output function · 3-wire DC PNP · 2-wire DC PNP/NPN · Wiring diagram no. 38 · Connector groups 8, 10, 11, 18, 20

	M8 / L = 37	3 f	Brass	10...30	IP 67	1000	100	29	IE5351
	M8 / L = 37	5 nf	Brass	10...30	IP 67	700	100	30	IE5352



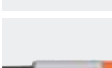













Cable 0.3 m · with M8 connector (snap-fit) · Output function · 3-wire DC PNP · 2-wire DC PNP/NPN · Wiring diagram no. 38 · Connector groups 1, 2, 3

	M8 / L = 37	3 f	Brass	10...30	IP 67	1000	100	31	IE5344
	M8 / L = 37	5 nf	Brass	10...30	IP 67	700	100	30	IE5346

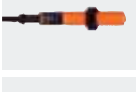
Cable 2 m · Output function · 3-wire DC PNP · 2-wire DC PNP/NPN · Wiring diagram no. 40

	M8 / L = 37	3 f	Brass	10...30	IP 67	1000	100	29	IE5343
	M8 / L = 37	5 nf	Brass	10...30	IP 67	700	100	30	IE5345

Product selectors and further information can be found at: www.ifm.com

Type	Dimensions [mm]	Sensing range [mm]	Material	U _b [V]	Protection	f [Hz]	I _{load} [mA]	Draw- ing no.	Order no.
Cable 2 m · Output function  · 3-wire · DC PNP · Wiring diagram no. 4									
	M8 / L = 35	1 f	Brass	10...36	IP 67	750	200	32	IE5072
	M8 / L = 35	2 nf	PBT	10...36	IP 67	800	200	32	IE5099
	M8 / L = 50	1 f	Brass	10...36	IP 67	750	200	33	IE5121
	M8 / L = 50	1 f	PBT	10...36	IP 67	1000	200	33	IE5129
	M8 / L = 20	1.5 f	stainless steel	10...30	IP 67	4000	200	34	IE5348
	M8 / L = 27	2 f	High-grade st. steel	10...30	IP 67	1500	100	35	IE5368
	M8 / L = 27	4 nf	High-grade st. steel	10...30	IP 67	500	100	36	IE5369
	M12 / L = 35	2 f	Brass	10...36	IP 67	1500	150	37	IF5188
	M12 / L = 35	4 nf	Brass	10...36	IP 67	1500	150	38	IF5249
	M12 / L = 71	2 f	Brass	10...55	IP 67	800	250	39	IF5297
	M12 / L = 71	2 f	PBT	10...55	IP 67	800	250	39	IF5313
	M12 / L = 71	4 nf	Brass	10...36	IP 67	1500	250	40	IF5329
	M12 / L = 71	4 nf	PBT	10...36	IP 67	400	250	39	IF5345
	M18 / L = 38	5 f	Brass	18...36	IP 67	500	125	41	IG5221
	M18 / L = 38	8 nf	Brass	18...36	IP 67	200	125	42	IG5285
	M18 / L = 80	5 f	Brass	10...36	IP 67	500	250	43	IG5397





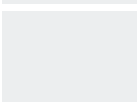













You can find wiring diagrams and scale drawings from page 125

Position sensors

Type	Dimensions [mm]	Sensing range [mm]	Material	U _b [V]	Protection	f [Hz]	I _{load} [mA]	Draw- ing no.	Order no.
Cable 2 m · Output function  · 3-wire · DC PNP · Wiring diagram no. 4									
	M18 / L = 80	8 nf	Brass	10...36	IP 67	300	250	44	IG5398
	M18 / L = 80	5 f	PBT	10...36	IP 67	500	250	43	IG5399
	M18 / L = 80	8 nf	PBT	10...36	IP 67	300	250	43	IG5401
	M30 / L = 45	10 f	Brass	18...36	IP 67	300	125	45	I15166
	M30 / L = 81	10 f	Brass	10...36	IP 67	250	250	46	I15256
	M30 / L = 81	15 nf	Brass	10...36	IP 67	250	250	47	I15284
	M30 / L = 81	15 nf	PBT	10...36	IP 67	250	250	46	I15300
	M30 / L = 45	15 nf	Brass	18...36	IP 67	250	125	48	I15346
	M30 / L = 81	10 f	PBT	10...36	IP 67	250	250	46	I15369
	M5 / L = 30	0.8 f	stainless steel	10...36	IP 65	2000	100	49	IY5029
	M5 / L = 27	1.5 nf	stainless steel	10...30	IP 67	1800	100	50	IY5049
	M5 / L = 23	0.8 f	stainless steel	10...30	IP 65	2000	100	51	IY5051
	M5 / L = 23	1.2 f	stainless steel	10...30	IP 65	2000	100	51	IY5052
Cable 2 m · Output function  · 2-wire · DC PNP/NPN · Wiring diagram no. 41									
	M8 / L = 50	2 nf	PBT (Pocan)	5...36	IP 67	2000	200	33	IE5202
	M8 / L = 50	1 f	Brass	5...36	IP 67	2000	200	33	IE5222

Type	Dimensions [mm]	Sensing range [mm]	Material	U _b [V]	Protection	f [Hz]	I _{load} [mA]	Drawing no.	Order no.
Cable 2 m · Output function  /  · 2-wire · DC PNP/NPN · Wiring diagram no. 41									
	M8 / L = 50	2 nf	Brass	5...36	IP 67	2700	200	52	IE5238
	M12 / L = 71	4 nf	PBT	10...55	IP 67	1500	400	39	IF5597
	M12 / L = 71	2 f	PBT	10...55	IP 67	1100	400	39	IF5644
	M12 / L = 71	2 f	Brass	10...55	IP 67	1100	400	39	IF5645
	M12 / L = 71	4 nf	Brass	10...55	IP 67	1500	400	40	IF5646
	M18 / L = 80	8 nf	PBT	10...55	IP 67	300	400	43	IG5533
	M18 / L = 80	5 f	PBT	10...55	IP 67	700	400	43	IG5593
	M18 / L = 80	5 f	Brass	10...55	IP 67	700	400	43	IG5594
	M18 / L = 80	8 nf	Brass	10...55	IP 67	300	400	44	IG5596
	M30 / L = 81	15 nf	PBT	10...55	IP 67	200	400	46	I15436
	M30 / L = 81	10 f	PBT	10...55	IP 67	450	400	46	I15488
	M30 / L = 81	10 f	Brass	10...55	IP 67	450	400	46	I15489
	M30 / L = 81	15 nf	Brass	10...55	IP 67	200	400	47	I15491
	M30 / L = 45	10 f	Brass	10...55	IP 67	450	400	45	I15493
M12 connector · Output function  · 3-wire · DC PNP · Wiring diagram no. 1 · Connector groups 8, 10, 18, 20, 120, 124, 126, 128, 157									
	M12 / L = 45	2 f	Brass	10...30	IP 67	700	100	11	IF5214

Position sensors

Type	Dimensions [mm]	Sensing range [mm]	Material	U _b [V]	Protection	f [Hz]	I _{load} [mA]	Draw- ing no.	Order no.
M12 connector · Output function  · 3-wire · DC PNP · Wiring diagram no. 1 · Connector groups 8, 10, 18, 20, 120, 124, 126, 128, 157									
	M12 / L = 50	4 nf	Brass	10...30	IP 67	700	100	12	IFS215
M12 connector · Output function  · 3-wire · DC PNP · Wiring diagram no. 1 · Connector groups 8, 10, 11, 18, 20									
	M12 / L = 70	2 f	Brass	10...36	IP 67	700	100	5	IFS216
	M12 / L = 70	4 nf	Brass	10...36	IP 67	700	100	6	IFS217
	M18 / L = 46	5 f	Brass	10...36	IP 67	400	100	3	IGS214
	M18 / L = 70	5 f	Brass	10...36	IP 67	400	100	7	IGS216
	M18 / L = 70	8 nf	Brass	10...36	IP 67	300	100	8	IGS217
	M8 / L = 53	1 f	Brass	10...36	IP 67	750	200	53	IE5090
	M8 / L = 62	4 nf	Brass	10...36	IP 67	300	200	54	IE5288
	M8 / L = 62	2 f	Brass	10...36	IP 67	1000	250	55	IE5312
	M8 / L = 50	2 f	High-grade st. steel	10...36	IP 68 / IP 69K	1000	100	56	IE5379
M12 connector · Output function  · 3-wire · DC PNP · Wiring diagram no. 2 · Connector groups 8, 10, 18, 20									
	M8 / L = 62	2 f	Brass	10...36	IP 67	800	250	57	IE5327
M12 connector · Output function  · 2-wire · DC PNP/NPN · Wiring diagram no. 39 · Connector groups 8, 10, 18, 20									
	M8 / L = 69	1 f	Brass	5...36	IP 67	2700	200	58	IE5203
	M12 / L = 83	2 f	Brass	10...55	IP 67	1100	300	59	IF5598
	M12 / L = 83	4 nf	Brass	10...55	IP 67	1500	300	60	IF5647



Type	Dimensions [mm]	Sensing range [mm]	Material	U _b [V]	Protection	f [Hz]	I _{load} [mA]	Draw- ing no.	Order no.
M12 connector · Output function  /  · 2-wire · DC PNP/NPN · Wiring diagram no. 39 · Connector groups 8, 10, 18, 20									
	M18 / L = 70	5 f	Brass	10...55	IP 67	700	400	61	IG5595
	M18 / L = 76	8 nf	Brass	10...55	IP 67	300	400	62	IG5597
	M30 / L = 78	10 f	Brass	10...55	IP 67	450	400	63	I15490
	M30 / L = 78	15 nf	Brass	10...55	IP 67	200	400	64	I15492
M8 connector · Output function  · 3-wire DC PNP · 2-wire DC PNP/NPN · Wiring diagram no. 38 · Connector groups 1, 2, 3									
	M8 / L = 40	3 f	Brass	10...30	IP 65 / IP 67	800	100	65	IE5338
	M8 / L = 40	5 nf	High-grade st. steel	10...30	IP 65 / IP 67	600	100	66	IE5340
M8 connector · Output function  · 3-wire · DC PNP · Wiring diagram no. 1 · Connector groups 1, 2, 3									
	M8 / L = 50	2 f	Brass	10...36	IP 65 / IP 67	1300	200	67	IE5287
	M8 / L = 30.5	2 f	High-grade st. steel	10...30	IP 65 / IP 67	800	100	68	IE5366
	M8 / L = 30.5	4 nf	High-grade st. steel	10...30	IP 65 / IP 67	800	100	69	IE5367
	M5 / L = 45	0.8 f	stainless steel	10...36	IP 65	2000	100	70	IY5036
	M5 / L = 41	1.5 nf	stainless steel	10...30	IP 67	1800	100	71	IY5048
M8 connector · Output function  · 3-wire DC PNP · 2-wire DC PNP/NPN · Wiring diagram no. 42 · Connector groups 1, 2, 3									
	M8 / L = 40	3 f	Brass	10...30	IP 65 / IP 67	800	100	65	IE5349
	M8 / L = 40	5 nf	High-grade st. steel	10...30	IP 65 / IP 67	600	100	66	IE5350

Position sensors

Type	Dimensions [mm]	Sensing range [mm]	Material	U _b [V]	Protection	f [Hz]	I _{load} [mA]	Drawing no.	Order no.
------	--------------------	-----------------------	----------	-----------------------	------------	-----------	---------------------------	-------------	-----------

M8 connector · Output function  · 3-wire · DC PNP · Wiring diagram no. 6 · Connector groups 1, 2, 3

	M8 / L = 50	1 f	Brass	10...36	IP 65 / IP 67	2000	200	67	IE5258
---	-------------	-----	-------	---------	---------------	------	-----	----	---------------

Terminals · Output function  /  · 2-wire · DC PNP/NPN · Wiring diagram no. 43







	M18 / L = 110	5 f	PBT	10...55	IP 65	800	400	72	IG5718
	M18 / L = 110	8 nf	PBT	10...55	IP 65	300	400	72	IG5719







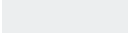
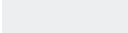

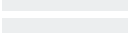



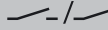

f = flush / nf = non flush

Sensors for industrial applications with smooth sleeve

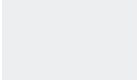
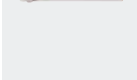
Type	Dimensions [mm]	Sensing range [mm]	Material	U _b [V]	Protection	f [Hz]	I _{load} [mA]	Drawing no.	Order no.
------	--------------------	-----------------------	----------	-----------------------	------------	-----------	---------------------------	-------------	-----------

Cable 2 m · Output function  · 3-wire · DC PNP · Wiring diagram no. 4

	Ø 20 / L = 77	10 nf	PBT	10...36	IP 67	300	250	73	IA5082
	Ø 34 / L = 82	20 nf	PBT	10...36	IP 67	60	250	74	IB5096
	Ø 6.5 / L = 35	1 f	Brass	10...36	IP 67	900	200	75	IT5001
	Ø 6.5 / L = 19	2 f	stainless steel	10...30	IP 67	1000	200	76	IT5039
	Ø 6.5 / L = 27	2 f	High-grade st. steel	10...30	IP 67	1500	100	77	IT5042
	Ø 4 / L = 30	0.8 f	stainless steel	10...36	IP 65	2000	100	78	IZ5026
	Ø 4 / L = 27	1.5 nf	stainless steel	10...30	IP 67	1800	100	79	IZ5047
	Ø 3 / L = 27	1 nf	stainless steel	10...30	IP 67	5000	100	80	IZ5048
	Ø 4 / L = 23	0.8 f	stainless steel	10...30	IP 65	2000	100	81	IZ5051

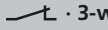
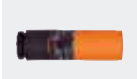
Type	Dimensions [mm]	Sensing range [mm]	Material	U _b [V]	Protection	f [Hz]	I _{load} [mA]	Draw- ing no.	Order no.
Cable 2 m · Output function  · 3-wire · DC PNP · Wiring diagram no. 4									
	Ø 4 / L = 23	1.2 f	stainless steel	10...30	IP 65	2000	100	81	IZ5052
Cable 2 m · Output function  · 2-wire · DC PNP/NPN · Wiring diagram no. 41									
	Ø 20 / L = 77	10 nf	PBT	10...55	IP 67	300	400	73	IA5108
M12 connector · Output function  · 3-wire · DC PNP · Wiring diagram no. 1 · Connector groups 8, 10, 11, 18, 20									
	Ø 20 / L = 93	10 nf	PBT	10...36	IP 67	300	250	82	IA5127
M8 connector · Output function  · 3-wire · DC PNP · Wiring diagram no. 1 · Connector groups 1, 2, 3									
	Ø 4 / L = 41	1.5 nf	stainless steel	10...30	IP 67	1800	100	83	IZ5046
	Ø 6.5 / L = 50	1 f	Brass	10...36	IP 65 / IP 67	2000	200	84	IT5021
	Ø 6.5 / L = 50	1.5 f	Brass	10...36	IP 65 / IP 67	1700	200	84	IT5034
	Ø 6.5 / L = 30.5	2 f	High-grade st. steel	10...30	IP 65 / IP 67	800	100	85	IT5040
	Ø 6.5 / L = 50	4 nf	High-grade st. steel	10...30	IP 67	300	100	86	IT5044
	Ø 4 / L = 45	0.8 f	stainless steel	10...36	IP 65	2000	100	87	IZ5035
Terminals · Output function  · 3-wire · DC PNP · Wiring diagram no. 7									
	Ø 20 / L = 92	10 nf	PBT	10...36	IP 65	300	250	88	IA5062
Terminals · Output function  · 3-wire · DC PNP · Wiring diagram no. 7									
	Ø 20 / L = 92	10 nf	PBT	10...36	IP 65	300	250	88	IA5063

Position sensors

Type	Dimensions [mm]	Sensing range [mm]	Material	U _b [V]	Protection	f [Hz]	I _{load} [mA]	Drawing no.	Order no.
------	--------------------	-----------------------	----------	-----------------------	------------	-----------	---------------------------	-------------	-----------

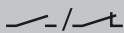
Terminals · Output function  · 2-wire · DC PNP/NPN · Wiring diagram no. 43

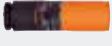
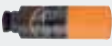
	∅ 20 / L = 92	10 nf	PBT	10...55	IP 65	300	300	88	IA5122
	∅ 34 / L = 98	20 nf	PBT	10...55	IP 65	300	300	89	IB5124

Terminals · Output function  · 3-wire · DC PNP · Wiring diagram no. 7

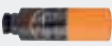
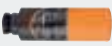





	∅ 34 / L = 98	20 nf	PBT	10...36	IP 65	350	250	89	IB5063
	∅ 34 / L = 98	30 nf	PBT	10...36	IP 65	350	200	89	IB5133

f = flush / nf = non flush

Sensors for industrial applications, rectangular housings

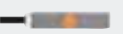

















Type	Dimensions [mm]	Sensing range [mm]	Material	U _b [V]	Protection	f [Hz]	I _{load} [mA]	Drawing no.	Order no.
------	--------------------	-----------------------	----------	-----------------------	------------	-----------	---------------------------	-------------	-----------











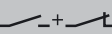

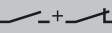

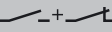

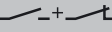
Cable 2 m · Output function  · 3-wire · DC PNP · Wiring diagram no. 4

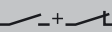
	120 x 80 x 30	50 nf	PPE	10...36	IP 67	100	250	90	ID5026
	40 x 8 x 8	2 f	Brass	10...36	IP 65	2000	250	91	IL5002
	40 x 8 x 8	2 f	Brass	10...36	IP 65	2000	250	92	IL5003
	40 x 8 x 8	2.5 f	Brass	10...36	IP 65	2000	250	91	IL5020
	25 x 5 x 5	0.8 f	aluminium	10...30	IP 67	1000	100	93	IL5022
	40 x 12 x 26	2 f	PBT	10...36	IP 67	1400	250	94	IN5121
	40 x 12 x 26	4 nf	PBT	10...36	IP 67	1300	250	94	IN5129
	28 x 10 x 16	2 f	PBT	10...36	IP 67	800	200	95	IS5001

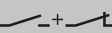
Type	Dimensions [mm]	Sensing range [mm]	Material	U _b [V]	Protection	f [Hz]	I _{load} [mA]	Draw- ing no.	Order no.
Cable 2 m · Output function  · 3-wire · DC PNP · Wiring diagram no. 4									
	28 x 10 x 16	3 nf	PBT	10...36	IP 67	100	200	95	IS5031
	28 x 10 x 16	4 nf	PBT	10...36	IP 67	2000	250	96	IS5070
	60 x 36 x 10	5 f	PBT	10...36	IP 67	400	250	97	IW5051
	60 x 36 x 10	8 nf	PBT	10...36	IP 67	300	250	97	IW5058
Cable 2 m · Output function  · 3-wire · DC PNP · Wiring diagram no. 8									
	40 x 12 x 26	2 f	PBT	10...36	IP 67	1400	250	94	IN5186
	40 x 12 x 26	4 nf	PBT	10...36	IP 67	1300	250	94	IN5188
	60 x 36 x 10	8 nf	PBT	10...36	IP 67	300	250	98	IW5053
Cable 2 m · Output function  · 2-wire · DC PNP/NPN · Wiring diagram no. 41									
	40 x 12 x 26	2 f	PBT	10...55	IP 67	1300	400	94	IN5207
	40 x 12 x 26	4 nf	PBT	10...55	IP 67	1200	300	94	IN5208
	28 x 10 x 16	2 f	PBT	5...36	IP 67	2000	200	95	IS5026
M12 connector · 2-wire · AS-i · Wiring diagram no. 9 · Connector groups 8, 10, 18, 20									
	40 x 40 x 54	15 f	PBT	26.5...31.6	IP 67	100	–	99	IM5118
M12 connector · Output function  · 3-wire · DC PNP · Wiring diagram no. 1 · Connector groups 8, 10, 11, 18, 20									
	92 x 80 x 40	50 f	PPE	10...36	IP 67	70	250	100	ID5055
	40 x 40 x 54	20 f	PA (polyamide)	10...36	IP 67	100	200	99	IM5115
	40 x 40 x 54	35 nf	PA (polyamide)	10...36	IP 67	80	200	99	IM5116

Position sensors

Type	Dimensions [mm]	Sensing range [mm]	Material	U _b [V]	Protection	f [Hz]	I _{load} [mA]	Drawing no.	Order no.
M12 connector · Output function  · 3-wire · DC PNP · Wiring diagram no. 1 · Connector groups 8, 10, 11, 18, 20									
	40 x 40 x 54	40 nf	PA (polyamide)	10...36	IP 67	60	200	99	IM5117
M12 connector · Output function  · 3-wire · DC PNP · Wiring diagram no. 1 · Connector groups 114, 115, 116, 117									
	40 x 40 x 54	20 f	PA (polyamide)	10...36	IP 67	200	200	101	IM5119
	40 x 40 x 54	35 nf	PA (polyamide)	10...36	IP 67	200	200	101	IM5120
M12 connector · Output function  · 3-wire · DC PNP · Wiring diagram no. 1 · Connector groups 8, 10, 11, 18, 20									
	40 x 40 x 54	20 f	PA (polyamide)	10...36	IP 67	200	200	99	IM5128
M12 connector · Output function  · 3-wire · DC PNP · Wiring diagram no. 1 · Connector groups 114, 115, 116, 117									
	40 x 40 x 54	40 nf	PA (polyamide)	10...36	IP 67	200	200	101	IM5129
M12 connector · Output function  · 3-wire · DC PNP · Wiring diagram no. 1 · Connector groups 8, 10, 11, 18, 20									
	40 x 40 x 54	35 nf	PA (polyamide)	10...36	IP 67	200	200	99	IM5130
	40 x 40 x 54	40 nf	PA (polyamide)	10...36	IP 67	200	200	99	IM5131
M12 connector · Output function  /  · 3-wire · DC PNP · Wiring diagram no. 1 · Connector groups 8, 10, 11, 18, 20									
	105 x 80 x 40	60 nf	PPE	10...36	IP 67	100	250	102	ID5046
M12 connector · Output function  +  · 4-wire · DC PNP · Wiring diagram no. 10 · Connector groups 114, 115, 116, 117									
	40 x 40 x 54	20 f	PA (polyamide)	10...36	IP 67	200	200	101	IM5124
	40 x 40 x 54	35 nf	PA (polyamide)	10...36	IP 67	200	200	101	IM5125
	40 x 40 x 54	40 nf	PA (polyamide)	10...36	IP 67	200	200	101	IM5126
M12 connector · Output function  +  · 4-wire · DC PNP · Wiring diagram no. 10 · Connector groups 8, 10, 11, 18, 20									
	92 x 80 x 40	50 f	PPE	10...36	IP 67	70	250	100	ID5058

Type	Dimensions [mm]	Sensing range [mm]	Material	U _b [V]	Protection	f [Hz]	I _{load} [mA]	Drawing no.	Order no.
M12 connector · Output function  · 4-wire · DC PNP · Wiring diagram no. 10 · Connector groups 114, 115, 116, 117									
	40 x 40 x 54	20 f	PA (polyamide)	10...36	IP 67	200	200	99	IM5132
M12 connector · Output function  · 4-wire · DC PNP · Wiring diagram no. 10 · Connector groups 8, 9, 10, 11, 18, 20, 120, 124, 126, 128, 130, 131, 157, 158									
	40 x 40 x 54	35 nf	PA (polyamide)	10...36	IP 67	200	200	99	IM5133
M12 connector · Output function  · 4-wire · DC PNP · Wiring diagram no. 10 · Connector groups 8, 10, 11, 18, 20									
	40 x 40 x 54	35 nf	PA (polyamide)	10...36	IP 67	80	200	99	IM5134
M12 connector · Output function  · 4-wire · DC PNP · Wiring diagram no. 10 · Connector groups 8, 9, 10, 11, 18, 20, 120, 124, 126, 128, 130, 131, 157, 158									
	40 x 40 x 54	40 nf	PA (polyamide)	10...36	IP 67 / IP 69K	200	200	99	IM5135
M12 connector · Output function  · 4-wire · DC PNP · Wiring diagram no. 10 · Connector groups 8, 10, 11, 18, 20									
	40 x 40 x 54	40 nf	PA (polyamide)	10...36	IP 67	60	200	99	IM5136
M12 connector · Output function  · 4-wire · DC PNP · Wiring diagram no. 10 · Connector groups 8, 10, 18, 20									
	40 x 40 x 54	20 f	PA (polyamide)	10...36	IP 67	100	200	99	IM5123
M8 connector · Output function  · 3-wire · DC PNP · Wiring diagram no. 1 · Connector groups 1, 2, 3									
	40 x 8 x 8	2 f	Brass	10...36	IP 65	2000	250	103	IL5004
	40 x 8 x 8	2 f	Brass	10...36	IP 65	2000	250	104	IL5005
	40 x 12 x 26	4 nf	PBT	10...36	IP 65	1300	250	105	IN5212
	40 x 12 x 26	2 f	PBT	10...36	IP 67	1400	250	105	IN5230
	28 x 10 x 16	2 f	PBT	10...36	IP 67	800	200	106	IS5035
	28 x 10 x 16	4 nf	PBT	10...36	IP 67	2000	250	106	IS5071

Position sensors

Type	Dimensions [mm]	Sensing range [mm]	Material	U _b [V]	Protection	f [Hz]	I _{load} [mA]	Draw- ing no.	Order no.
M8 connector · Output function  · 3-wire · DC PNP · Wiring diagram no. 1 · Connector groups 1, 2, 3									
	60 x 36 x 10	8 nf	PBT	10...36	IP 65	300	250	107	IW5064
M8 connector · Output function  · 3-wire · DC PNP · Wiring diagram no. 6 · Connector groups 1, 2, 3									
	60 x 36 x 10	8 nf	PBT	10...36	IP 67	300	250	107	IW5062
Terminals · Output function  · 2-wire · DC PNP/NPN · Wiring diagram no. 43									
	40 x 40 x 120	15 f	PPE	10...55	IP 65	350	400	108	IM5037
	40 x 40 x 120	20 nf	PPE	10...55	IP 65	300	400	108	IM5038
Terminals · Output function  · 3-wire · DC PNP · Wiring diagram no. 7									
	40 x 40 x 120	20 nf	PPE	10...36	IP 65	350	250	108	IM5019
	40 x 40 x 120	15 f	PPE	10...36	IP 65	350	250	108	IM5020
	40 x 40 x 120	30 nf	PPE	10...36	IP 65	100	250	108	IM5046
Terminals · Output function  · 3-wire · DC PNP · Wiring diagram no. 44									
	90 x 60 x 40	40 nf	PPE	10...36	IP 65	15	250	109	IC5005
	105 x 80 x 40	60 nf	PPE	10...36	IP 65	100	250	110	ID5005
Terminals · Output function  · 4-wire · DC PNP · Wiring diagram no. 11									
	40 x 40 x 118	15 f	PBT	10...60	IP 67	150	200	111	IV5003
	40 x 40 x 118	20 f	PBT	10...60	IP 67	150	200	112	IV5004

f = flush / nf = non flush

Sensors for industrial applications, AC and AC/DC

Type	Dimensions [mm]	Sensing range [mm]	Material	U_b [V]	Protection	f AC / DC [Hz]	I_{load} AC / DC [mA]	Drawing no.	Order no.
------	--------------------	-----------------------	----------	--------------	------------	----------------------	-------------------------------	-------------	-----------

 1/2" connector · Output function  · 2-wire · AC/DC · Wiring diagram no. 12 · Connector group 29

40 x 40 x 66	35 nf	PPE	20...250	IP 67	20 / 50	250 / 100	113	IM0049*
--------------	-------	-----	----------	-------	---------	-----------	-----	----------------

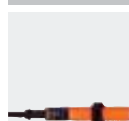
 Cable 2 m · Output function  · 2-wire · AC · Wiring diagram no. 3

M12 / L = 71.5	2 f	PBT	20...250	IP 67	25	200	114	IF0001*
----------------	-----	-----	----------	-------	----	-----	-----	----------------

M12 / L = 71.5	4 nf	PBT	20...250	IP 67	25	200	114	IF0003*
----------------	------	-----	----------	-------	----	-----	-----	----------------

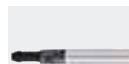

M12 / L = 71.5	2 f	Brass	20...250	IP 67	25	200	114	IF0005*
----------------	-----	-------	----------	-------	----	-----	-----	----------------



M12 / L = 71	4 nf	Brass	20...250	IP 67	25	200	115	IF0007*
--------------	------	-------	----------	-------	----	-----	-----	----------------

 Cable 2 m · Output function  · 2-wire · AC/DC · Wiring diagram no. 13

Ø 20 / L = 77	10 nf	PBT	20...250	IP 67	25 / 70	250 / 100	73	IA0004*
---------------	-------	-----	----------	-------	---------	-----------	----	----------------

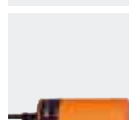

Ø 34 / L = 82	20 nf	PBT	20...250	IP 67	25 / 50	250 / 100	74	IB0004*
---------------	-------	-----	----------	-------	---------	-----------	----	----------------



Ø 34 / L = 82	30 nf	PBT	20...250	IP 67	25 / 50	250 / 100	74	IB0026*
---------------	-------	-----	----------	-------	---------	-----------	----	----------------



120 x 80 x 30	50 nf	modified PPE	20...250	IP 65	25 / 35	250 / 100	90	ID0014*
---------------	-------	--------------	----------	-------	---------	-----------	----	----------------



M18 / L = 80	5 f	PBT	20...250	IP 67	25 / 50	250 / 100	43	IG0005*
--------------	-----	-----	----------	-------	---------	-----------	----	----------------

M18 / L = 80	8 nf	PBT	20...250	IP 67	25 / 50	250 / 100	43	IG0006*
--------------	------	-----	----------	-------	---------	-----------	----	----------------



M18 / L = 80	5 f	Brass	20...250	IP 67	25 / 50	250 / 100	43	IG0011*
--------------	-----	-------	----------	-------	---------	-----------	----	----------------



M18 / L = 80	8 nf	Brass	20...250	IP 67	25 / 50	250 / 100	44	IG0012*
--------------	------	-------	----------	-------	---------	-----------	----	----------------





M30 / L = 81	10 f	PBT	20...250	IP 67	25 / 50	250 / 100	46	I10005*
--------------	------	-----	----------	-------	---------	-----------	----	----------------

Position sensors

Type	Dimensions [mm]	Sensing range [mm]	Material	U _b [V]	Protection	f AC / DC [Hz]	I _{load} AC / DC [mA]	Draw- ing no.	Order no.
Cable 2 m · Output function  · 2-wire · AC/DC · Wiring diagram no. 13									
	M30 / L = 81	15 nf	PBT	20...250	IP 67	25 / 50	250 / 100	46	II0006*
	M30 / L = 81	10 f	Brass	20...250	IP 67	25 / 50	250 / 100	46	II0011*
	M30 / L = 81	15 nf	Brass	20...250	IP 67	25 / 50	250 / 100	47	II0012*
	40 x 12 x 26	2 f	PBT	20...250	IP 67	25 / 50	250 / 100	94	IN0073*
	40 x 12 x 26	4 nf	PBT	20...250	IP 67	25 / 50	250 / 100	94	IN0081*
Cable 2 m · Output function  · 2-wire · AC/DC · Wiring diagram no. 14									
	∅ 20 / L = 77	10 nf	PBT	20...250	IP 67	25 / 70	250 / 100	73	IA0027*
	∅ 34 / L = 82	20 nf	PBT	20...250	IP 67	25 / 50	250 / 100	74	IB0017*
	∅ 34 / L = 82	30 nf	PBT	20...250	IP 67	25 / 50	250 / 100	74	IB0027*
	40 x 12 x 26	2 f	PBT	20...250	IP 67	25 / 50	250 / 100	94	IN0077*
	40 x 12 x 26	4 nf	PBT	20...250	IP 67	25 / 50	250 / 100	94	IN0085*
M12 connector · Output function  · 2-wire · AC/DC · Wiring diagram no. 12 · Connector group 7									
	40 x 40 x 66	35 nf	PPE	20...250	IP 67	20 / 50	250 / 100	116	IM0053*
	92 x 80 x 40	50 f	modified PPE	20...250	IP 67	25	250 / 100	100	ID0049*
	40 x 40 x 66	20 f	PPE	20...250	IP 67	25 / 140	250 / 100	116	IM0054*
Terminals · Output function  · 2-wire · AC/DC · Wiring diagram no. 45									
	90 x 60 x 40	40 nf	PPE	20...250	IP 65	10	250 / 100	109	IC0003*

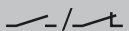
Type	Dimensions [mm]	Sensing range [mm]	Material	U _b [V]	Protection	f AC / DC [Hz]	I _{load} AC / DC [mA]	Draw- ing no.	Order no.
------	--------------------	--------------------------	----------	-----------------------	------------	----------------------	--------------------------------------	---------------------	--------------

Terminals · Output function  · 2-wire · AC/DC · Wiring diagram no. 45

	105 x 80 x 40	60 nf	modified PPE	20...250	IP 65	4	250 / 100	110	ID0013*
---	---------------	-------	--------------	----------	-------	---	-----------	-----	----------------

Terminals · Output function  · 2-wire · AC/DC · Wiring diagram no. 15

	∅ 20 / L = 92	10 nf	PBT	20...250	IP 65	25 / 70	250 / 100	88	IA0032*
---	---------------	-------	-----	----------	-------	---------	-----------	----	----------------

	∅ 34 / L = 98	20 nf	PBT	20...250	IP 65	25 / 50	250 / 100	89	IB0016*
---	---------------	-------	-----	----------	-------	---------	-----------	----	----------------

	40 x 40 x 120	20 nf	PPE	20...250	IP 65	20 / 55	250 / 100	108	IM0010*
---	---------------	-------	-----	----------	-------	---------	-----------	-----	----------------

	40 x 40 x 120	15 f	PPE	20...250	IP 65	20 / 55	250 / 100	108	IM0011*
---	---------------	------	-----	----------	-------	---------	-----------	-----	----------------

f = flush / nf = non flush

* Note for AC and AC/DC units

Miniature fuse to IEC60127-2 sheet 1, ≤ 2 A (fast acting) Recommendation: check the unit for reliable function after a short circuit.

Sensors for industrial applications with analogue output 4...20 mA

Type	Dimensions [mm]	Sensing range [mm]	Material	U _b [V]	Protection	f [Hz]	I _{load} [mA]	Draw- ing no.	Order no.
------	--------------------	--------------------------	----------	-----------------------	------------	-----------	---------------------------	---------------------	--------------

M12 connector · Output function 4...20 mA analogue · 3-wire · DC analogue · Wiring diagram no. 16 · Connector groups 8, 10, 18, 20

	M12 / L = 70	0.2...2 f	Brass	15...30	IP 67	–	–	5	IF6028
---	--------------	-----------	-------	---------	-------	---	---	---	---------------



	M12 / L = 70	0.4...4 nf	Brass	15...30	IP 67	–	–	6	IF6030
---	--------------	------------	-------	---------	-------	---	---	---	---------------

	M18 / L = 60	0.8...8 nf	Brass	15...30	IP 67	–	–	117	IG6083
---	--------------	------------	-------	---------	-------	---	---	-----	---------------

	M18 / L = 60	0.5...5 f	Brass	15...30	IP 67	–	–	118	IG6086
---	--------------	-----------	-------	---------	-------	---	---	-----	---------------







	M30 / L = 70	1.0...15 nf	Brass	15...30	IP 67	–	–	10	IJ5913
---	--------------	-------------	-------	---------	-------	---	---	----	---------------

Position sensors

Type	Dimensions [mm]	Sensing range [mm]	Material	U _b [V]	Protection	f [Hz]	I _{load} [mA]	Drawing no.	Order no.
M12 connector · Output function 4...20 mA analogue · 3-wire · DC analogue · Wiring diagram no. 16 · Connector groups 8, 10, 18, 20									
	M30 / L = 70	1.0...10 f	Brass	15...30	IP 67	–	–	9	II5916
	40 x 40 x 54	1...15 f	PA (polyamide)	15...30	IP 67	–	–	99	IM5139
	40 x 40 x 54	1...26 nf	PA (polyamide)	15...30	IP 67	–	–	99	IM5141







f = flush / nf = non flush

Sensors for industrial applications with analogue output 0...10 V

Type	Dimensions [mm]	Sensing range [mm]	Material	U _b [V]	Protection	f [Hz]	I _{load} [mA]	Drawing no.	Order no.
M12 connector · Output function 0...10 V analogue · 3-wire · DC analogue · Wiring diagram no. 16 · Connector groups 8, 10, 18, 20									
	M12 / L = 70	0.2...2 f	Brass	15...30	IP 67	–	–	5	IF6029
	M12 / L = 70	0.4...4 nf	Brass	15...30	IP 67	–	–	6	IF6031
	M18 / L = 60	0.8...8 nf	Brass	15...30	IP 67	–	–	117	IG6084
	M18 / L = 60	0.5...5 f	Brass	15...30	IP 67	–	–	118	IG6087
	M30 / L = 70	1.0...15 nf	Brass	15...30	IP 67	–	–	10	II5914
	M30 / L = 70	1.0...10 f	Brass	15...30	IP 67	–	–	9	II5917
	40 x 40 x 54	1...15 f	PA (polyamide)	15...30	IP 67	–	–	99	IM5140
	40 x 40 x 54	1...26 nf	PA (polyamide)	15...30	IP 67	–	–	99	IM5142





f = flush / nf = non flush

Sensors for industrial high temperature applications

Type	Dimensions [mm]	Sensing range [mm]	Material	U _b [V]	Protection	f [Hz]	I _{load} [mA]	Drawing no.	Order no.
Cable 5 m · Output function  · 3-wire · DC PNP · Wiring diagram no. 4									
	M12 / L = 56	3 f	stainless steel	10...35	IP 65	500	120	119	IF6074
	M18 / L = 77	8 nf	stainless steel	10...35	IP 65	400	150	120	IG6119
	M18 / L = 70	5 f	stainless steel	10...35	IP 65	400	150	121	IG6614
	M30 / L = 79	15 nf	stainless steel	10...35	IP 65	200	150	122	I15930
	M30 / L = 70	10 f	High-grade st. steel	10...35	IP 65	200	150	123	I15961
	M50 / L = 70	20 f	stainless steel	10...35	IP 65	100	150	124	I95045

f = flush / nf = non flush

Sensors for industrial applications on pipes and tubes



Type	Inside diameter [mm]	Operating principle	Minimum diameter of the steel ball [Ø mm]	Part speed max. [m/s]	Pulse stretching [ms]	Response time / break time [ms]	Drawing no.	Order no.
M12 connector · Output function  /  · 3-wire · DC NPN · Wiring diagram no. 17 · Connector groups 8, 10, 18, 20								
	10.1	static	1.5	35	10...150	0.5 / 10	125	I7R202
	10.1	dynamic	0.6	35	0.1...150	0.2 / 0.2	125	I7R204
	15.1	static	2	35	10...150	0.5 / 10	126	I7R206
	15.1	dynamic	0.8	35	0.1...150	0.2 / 0.2	126	I7R208
	20.1	static	2.5	35	10...150	0.5 / 10	127	I7R210
	20.1	dynamic	1.0	35	0.1...150	0.2 / 0.2	127	I7R212

You can find wiring diagrams and scale drawings from page 125

Position sensors

Type	Inside diameter [mm]	Operating principle	Minimum diameter of the steel ball [Ø mm]	Part speed max. [m/s]	Pulse stretching [ms]	Response time / break time [ms]	Drawing no.	Order no.
M12 connector · Output function  · 3-wire · DC NPN · Wiring diagram no. 17 · Connector groups 8, 10, 18, 20								
	25.1	static	3.0	35	10...150	0.5 / 10	128	I7R214
	25.1	dynamic	1.2	35	0.1...150	0.2 / 0.2	128	I7R216
M12 connector · Output function  · 3-wire · DC PNP · Wiring diagram no. 18 · Connector groups 8, 10, 11, 18, 20								
	10.1	static	1.5	35	10...150	0.5 / 10	125	I7R201
	10.1	dynamic	0.6	35	0.1...150	0.2 / 0.2	125	I7R203
	15.1	static	2	35	10...150	0.5 / 10	126	I7R205
	15.1	dynamic	0.8	35	0.1...150	0.2 / 0.2	126	I7R207
	20.1	static	2.5	35	10...150	0.5 / 10	127	I7R209
	20.1	dynamic	1.0	35	0.1...150	0.2 / 0.2	127	I7R211
	25.1	static	3.0	35	10...150	0.5 / 10	128	I7R213
	25.1	dynamic	1.2	35	0.1...150	0.2 / 0.2	128	I7R215
	51	static	6	35	10...150	0.5 / 10	129	I7R217

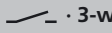
Tube sensors for industrial applications

Type	Sensing range [mm]	Operating principle	Minimum diameter of the steel ball [Ø mm]	Part speed max. [m/s]	Pulse stretching [ms]	Response time / break time [ms]	Drawing no.	Order no.
Cable 0.09 m · with M12 connector · Output function  · 3-wire · DC NPN · Wiring diagram no. 17 · Connector groups 8, 10, 18, 20, 120, 124, 126, 128, 157								
	≤ 14	static	3.0	35	100	0.5 / 100	130	I85003
	≤ 20	dynamic	1.0	35	100	0.2 / 100	130	I85007

Type	Sensing range [mm]	Operating principle	Minimum diameter of the steel ball [Ø mm]	Part speed max. [m/s]	Pulse stretching [ms]	Response time / break time [ms]	Drawing no.	Order no.
------	--------------------	---------------------	---	-----------------------	-----------------------	---------------------------------	-------------	-----------

Cable 0.09 m · with M12 connector · Output function  · 3-wire · DC PNP · Wiring diagram no. 18 · Connector groups 8, 10, 11, 18, 20, 120, 124, 126, 128, 130, 157, 158

	≤ 14	static	3.0	35	100	0.5 / 100	130	I85002
	≤ 20	dynamic	1.0	35	100	0.2 / 100	130	I85006

M8 connector · Output function  · 3-wire · DC NPN · Wiring diagram no. 17 · Connector groups 1, 3, 72, 78, 120

	≤ 14	static	3.0	35	100	0.5 / 100	131	I85001
	≤ 20	dynamic	1.0	35	100	0.2 / 100	131	I85005

M8 connector · Output function  · 3-wire · DC PNP · Wiring diagram no. 18 · Connector groups 1, 2, 3, 72, 78, 120, 122

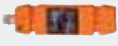
	≤ 14	static	3.0	35	100	0.5 / 100	131	I85000
	≤ 20	dynamic	1.0	35	100	0.2 / 100	131	I85004

Sensors for industrial applications, oils and coolants and mobile applications with increased sensing range

Type	Dimensions [mm]	Sensing range [mm]	Material	U _b [V]	Protection	f [Hz]	I _{load} [mA]	Drawing no.	Order no.
------	-----------------	--------------------	----------	--------------------	------------	--------	------------------------	-------------	-----------

Cable 2 m · Output function  · 3-wire · DC NPN · Wiring diagram no. 19

	M12 / L = 60	4 f	Brass	10...30	IP 65 / IP 66 / IP 67 / IP 68 / IP 69K	700	100	132	IFS254
	M12 / L = 60	7 nf	Brass	10...30	IP 65 / IP 66 / IP 67 / IP 68 / IP 69K	700	100	133	IFS255
	M12 / L = 40	4 f	Brass	10...30	IP 65 / IP 66 / IP 67 / IP 68 / IP 69K	700	100	134	IFS258
	M12 / L = 40	7 nf	Brass	10...30	IP 65 / IP 66 / IP 67 / IP 68 / IP 69K	700	100	135	IFS259











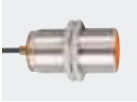

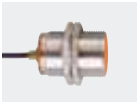

Cable 2 m · Output function  · 3-wire · DC PNP · Wiring diagram no. 8

	M12 / L = 60	4 f	Brass	10...30	IP 65 / IP 66 / IP 67 / IP 68 / IP 69K	700	100	132	IFS280
---	--------------	-----	-------	---------	--	-----	-----	-----	--------

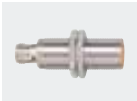
Position sensors



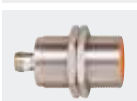



Type	Dimensions [mm]	Sensing range [mm]	Material	U _b [V]	Protection	f [Hz]	I _{load} [mA]	Draw- ing no.	Order no.
Cable 2 m · Output function  · 3-wire · DC PNP · Wiring diagram no. 8									
	M12 / L = 60	7 nf	Brass	10...30	IP 65 / IP 66 / IP 67 / IP 68 / IP 69K	700	100	133	IFS282
Cable 2 m · Output function  · 3-wire · DC NPN · Wiring diagram no. 20									
	M12 / L = 60	4 f	Brass	10...30	IP 65 / IP 66 / IP 67 / IP 68 / IP 69K	700	100	132	IFS281
	M12 / L = 60	7 nf	Brass	10...30	IP 65 / IP 66 / IP 67 / IP 68 / IP 69K	700	100	133	IFS283
Cable 2 m · Output function  · 3-wire · DC NPN · Wiring diagram no. 19									
	M18 / L = 60	8 f	Brass	10...30	IP 65 / IP 66 / IP 67 / IP 68 / IP 69K	400	100	136	IGS246
	M18 / L = 60	12 nf	Brass	10...30	IP 65 / IP 66 / IP 67 / IP 68 / IP 69K	300	100	137	IGS247
	M18 / L = 40	8 f	Brass	10...30	IP 65 / IP 66 / IP 67 / IP 68 / IP 69K	400	100	138	IGS250
	M18 / L = 40	12 nf	Brass	10...30	IP 65 / IP 66 / IP 67 / IP 68 / IP 69K	300	100	139	IGS251
Cable 2 m · Output function  · 3-wire · DC PNP · Wiring diagram no. 8									
	M18 / L = 60	8 f	Brass	10...30	IP 65 / IP 66 / IP 67 / IP 68 / IP 69K	400	100	136	IGS269
	M18 / L = 60	12 nf	Brass	10...30	IP 65 / IP 66 / IP 67 / IP 68 / IP 69K	300	100	137	IGS270
Cable 2 m · Output function  · 3-wire · DC NPN · Wiring diagram no. 20									
	M18 / L = 60	8 f	Brass	10...30	IP 65 / IP 66 / IP 67 / IP 68 / IP 69K	400	100	136	IGS271
	M18 / L = 60	12 nf	Brass	10...30	IP 65 / IP 66 / IP 67 / IP 68 / IP 69K	300	100	137	IGS272
Cable 2 m · Output function  · 3-wire · DC NPN · Wiring diagram no. 19									
	M30 / L = 60	15 f	Brass	10...30	IP 65 / IP 66 / IP 67 / IP 68 / IP 69K	100	100	140	IIS240
	M30 / L = 60	22 nf	Brass	10...30	IP 65 / IP 66 / IP 67 / IP 68 / IP 69K	100	100	141	IIS241

Type	Dimensions [mm]	Sensing range [mm]	Material	U _b [V]	Protection	f [Hz]	I _{load} [mA]	Draw- ing no.	Order no.
Table 2 m · Output function  · 3-wire · DC NPN · Wiring diagram no. 19									
	M30 / L = 45	15 f	Brass	10...30	IP 65 / IP 66 / IP 67 / IP 68 / IP 69K	100	100	142	IIS244
	M30 / L = 45	22 nf	Brass	10...30	IP 65 / IP 66 / IP 67 / IP 68 / IP 69K	100	100	143	IIS245
Table 2 m · Output function  · 3-wire · DC PNP · Wiring diagram no. 8									
	M30 / L = 60	15 f	Brass	10...30	IP 65 / IP 66 / IP 67 / IP 68 / IP 69K	100	100	140	IIS264
	M30 / L = 60	22 nf	Brass	10...30	IP 65 / IP 66 / IP 67 / IP 68 / IP 69K	100	100	141	IIS263
Table 2 m · Output function  · 3-wire · DC NPN · Wiring diagram no. 20									
	M30 / L = 60	15 f	Brass	10...30	IP 65 / IP 66 / IP 67 / IP 68 / IP 69K	100	100	140	IIS265
	M30 / L = 60	22 nf	Brass	10...30	IP 65 / IP 66 / IP 67 / IP 68 / IP 69K	100	100	141	IIS266
Table 2 m · Output function  · 3-wire · DC PNP · Wiring diagram no. 4									
	M12 / L = 60	4 f	Brass	10...30	IP 65 / IP 66 / IP 67 / IP 68 / IP 69K	700	100	132	IFS252
	M12 / L = 60	7 nf	Brass	10...30	IP 65 / IP 66 / IP 67 / IP 68 / IP 69K	700	100	133	IFS253
	M12 / L = 40	4 f	Brass	10...30	IP 65 / IP 66 / IP 67 / IP 68 / IP 69K	700	100	134	IFS256
	M12 / L = 40	7 nf	Brass	10...30	IP 65 / IP 66 / IP 67 / IP 68 / IP 69K	700	100	135	IFS257
	M18 / L = 60	8 f	Brass	10...30	IP 65 / IP 66 / IP 67 / IP 68 / IP 69K	400	100	136	IGS244
	M18 / L = 60	12 nf	Brass	10...30	IP 65 / IP 66 / IP 67 / IP 68 / IP 69K	300	100	137	IGS245
	M18 / L = 40	8 f	Brass	10...30	IP 65 / IP 66 / IP 67 / IP 68 / IP 69K	400	100	138	IGS248
	M18 / L = 40	12 nf	Brass	10...30	IP 65 / IP 66 / IP 67 / IP 68 / IP 69K	300	100	139	IGS249

Type	Dimensions [mm]	Sensing range [mm]	Material	U _b [V]	Protection	f [Hz]	I _{load} [mA]	Drawing no.	Order no.
Cable 2 m · Output function  · 3-wire · DC PNP · Wiring diagram no. 4									
	M30 / L = 60	15 f	Brass	10...30	IP 65 / IP 66 / IP 67 / IP 68 / IP 69K	100	100	140	IIS238
	M30 / L = 60	22 nf	Brass	10...30	IP 65 / IP 66 / IP 67 / IP 68 / IP 69K	100	100	141	IIS239
	M30 / L = 45	15 f	Brass	10...30	IP 65 / IP 66 / IP 67 / IP 68 / IP 69K	100	100	142	IIS242
	M30 / L = 45	22 nf	Brass	10...30	IP 65 / IP 66 / IP 67 / IP 68 / IP 69K	100	100	143	IIS243
M12 connector · Output function  · 3-wire · DC NPN · Wiring diagram no. 21 · Connector groups 8, 10, 18, 20, 157									
	M12 / L = 60	4 f	Brass	10...30	IP 65 / IP 66 / IP 67 / IP 68 / IP 69K	700	100	144	IFS242
	M12 / L = 60	7 nf	Brass	10...30	IP 65 / IP 66 / IP 67 / IP 68 / IP 69K	700	100	145	IFS243
	M12 / L = 45	4 f	Brass	10...30	IP 65 / IP 66 / IP 67 / IP 68 / IP 69K	700	100	11	IFS246
	M12 / L = 45	7 nf	Brass	10...30	IP 65 / IP 66 / IP 67 / IP 68 / IP 69K	700	100	146	IFS247
	M18 / L = 60	8 f	Brass	10...30	IP 65 / IP 66 / IP 67 / IP 68 / IP 69K	400	100	147	IGS234
	M18 / L = 60	12 nf	Brass	10...30	IP 65 / IP 66 / IP 67 / IP 68 / IP 69K	300	100	148	IGS235
	M18 / L = 45	8 f	Brass	10...30	IP 65 / IP 66 / IP 67 / IP 68 / IP 69K	400	100	15	IGS238
	M18 / L = 45	12 nf	Brass	10...30	IP 65 / IP 66 / IP 67 / IP 68 / IP 69K	300	100	149	IGS239
	M30 / L = 60	15 f	Brass	10...30	IP 65 / IP 66 / IP 67 / IP 68 / IP 69K	100	100	150	IIS228
	M30 / L = 60	22 nf	Brass	10...30	IP 65 / IP 66 / IP 67 / IP 68 / IP 69K	100	100	151	IIS229
	M30 / L = 50	15 f	Brass	10...30	IP 65 / IP 66 / IP 67 / IP 68 / IP 69K	100	100	152	IIS232



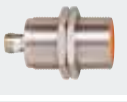
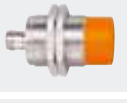

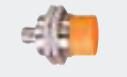

Type	Dimensions [mm]	Sensing range [mm]	Material	U _b [V]	Protection	f [Hz]	I _{load} [mA]	Draw- ing no.	Order no.
M12 connector · Output function  · 3-wire · DC NPN · Wiring diagram no. 21 · Connector groups 8, 10, 18, 20, 157									
	M30 / L = 50	22 nf	Brass	10...30	IP 65 / IP 66 / IP 67 / IP 68 / IP 69K	100	100	153	IIS233
M12 connector · Output function  · 3-wire · DC PNP · Wiring diagram no. 1 · Connector groups 8, 10, 18, 20, 157									
	M12 / L = 45	7 nf	Brass	10...30	IP 65 / IP 66 / IP 67 / IP 68 / IP 69K	700	100	146	IFS245
	M12 / L = 60	4 f	Brass	10...30	IP 65 / IP 66 / IP 67 / IP 68 / IP 69K	700	100	144	IFS240
	M12 / L = 60	7 nf	Brass	10...30	IP 65 / IP 66 / IP 67 / IP 68 / IP 69K	700	100	145	IFS241
	M18 / L = 60	8 f	Brass	10...30	IP 65 / IP 66 / IP 67 / IP 68 / IP 69K	400	100	147	IGS232
	M18 / L = 60	12 nf	Brass	10...30	IP 65 / IP 66 / IP 67 / IP 68 / IP 69K	300	100	148	IGS233
	M18 / L = 45	8 f	Brass	10...30	IP 65 / IP 66 / IP 67 / IP 68 / IP 69K	400	100	15	IGS236
	M18 / L = 45	12 nf	Brass	10...30	IP 65 / IP 66 / IP 67 / IP 68 / IP 69K	300	100	149	IGS237
	M30 / L = 60	15 f	Brass	10...30	IP 65 / IP 66 / IP 67 / IP 68 / IP 69K	100	100	150	IIS226
	M30 / L = 60	22 nf	Brass	10...30	IP 65 / IP 66 / IP 67 / IP 68 / IP 69K	100	100	151	IIS227
	M30 / L = 50	15 f	Brass	10...30	IP 65 / IP 66 / IP 67 / IP 68 / IP 69K	100	100	152	IIS230
	M30 / L = 50	22 nf	Brass	10...30	IP 65 / IP 66 / IP 67 / IP 68 / IP 69K	100	100	153	IIS231
	M12 / L = 45	4 f	Brass	10...30	IP 65 / IP 66 / IP 67 / IP 68 / IP 69K	700	100	11	IFS244
M12 connector · Output function  · 3-wire · DC NPN · Wiring diagram no. 22 · Connector groups 8, 10, 18, 20, 157									
	M12 / L = 60	4 f	Brass	10...30	IP 65 / IP 66 / IP 67 / IP 68 / IP 69K	700	100	144	IFS249

Type	Dimensions [mm]	Sensing range [mm]	Material	U _b [V]	Protection	f [Hz]	I _{load} [mA]	Drawing no.	Order no.
M12 connector · Output function  · 3-wire · DC NPN · Wiring diagram no. 22 · Connector groups 8, 10, 18, 20, 157									
	M12 / L = 60	7 nf	Brass	10...30	IP 65 / IP 66 / IP 67 / IP 68 / IP 69K	700	100	145	IFS251
	M12 / L = 45	4 f	Brass	10...30	IP 65 / IP 66 / IP 67 / IP 68 / IP 69K	700	100	11	IFS262
	M12 / L = 45	7 nf	Brass	10...30	IP 65 / IP 66 / IP 67 / IP 68 / IP 69K	700	100	146	IFS263
	M18 / L = 60	8 f	Brass	10...30	IP 65 / IP 66 / IP 67 / IP 68 / IP 69K	400	100	147	IGS241
	M18 / L = 60	12 nf	Brass	10...30	IP 65 / IP 66 / IP 67 / IP 68 / IP 69K	300	100	148	IGS243
	M18 / L = 45	8 f	Brass	10...30	IP 65 / IP 66 / IP 67 / IP 68 / IP 69K	400	100	15	IGS254
	M18 / L = 45	12 nf	Brass	10...30	IP 65 / IP 66 / IP 67 / IP 68 / IP 69K	300	100	149	IGS255
	M30 / L = 60	15 f	Brass	10...30	IP 65 / IP 66 / IP 67 / IP 68 / IP 69K	100	100	150	IIS235
	M30 / L = 60	22 nf	Brass	10...30	IP 65 / IP 66 / IP 67 / IP 68 / IP 69K	100	100	151	IIS237
	M30 / L = 50	15 f	Brass	10...30	IP 65 / IP 66 / IP 67 / IP 68 / IP 69K	100	100	152	IIS248
	M30 / L = 50	22 nf	Brass	10...30	IP 65 / IP 66 / IP 67 / IP 68 / IP 69K	100	100	153	IIS249
M12 connector · Output function  · 3-wire · DC PNP · Wiring diagram no. 2 · Connector groups 8, 10, 18, 20, 157									
	M12 / L = 60	4 f	Brass	10...30	IP 65 / IP 66 / IP 67 / IP 68 / IP 69K	700	100	144	IFS248
	M12 / L = 60	7 nf	Brass	10...30	IP 65 / IP 66 / IP 67 / IP 68 / IP 69K	700	100	145	IFS250
	M12 / L = 45	4 f	Brass	10...30	IP 65 / IP 66 / IP 67 / IP 68 / IP 69K	700	100	11	IFS260
	M12 / L = 45	7 nf	Brass	10...30	IP 65 / IP 66 / IP 67 / IP 68 / IP 69K	700	100	146	IFS261

Type	Dimensions [mm]	Sensing range [mm]	Material	U _b [V]	Protection	f [Hz]	I _{load} [mA]	Draw- ing no.	Order no.
M12 connector · Output function  · 3-wire · DC PNP · Wiring diagram no. 2 · Connector groups 8, 10, 18, 20, 157									
	M18 / L = 60	8 f	Brass	10...30	IP 65 / IP 66 / IP 67 / IP 68 / IP 69K	400	100	147	IGS240
	M18 / L = 60	12 nf	Brass	10...30	IP 65 / IP 66 / IP 67 / IP 68 / IP 69K	300	100	148	IGS242
	M18 / L = 45	8 f	Brass	10...30	IP 65 / IP 66 / IP 67 / IP 68 / IP 69K	400	100	15	IGS252
	M18 / L = 45	12 nf	Brass	10...30	IP 65 / IP 66 / IP 67 / IP 68 / IP 69K	300	100	149	IGS253
	M30 / L = 60	15 f	Brass	10...30	IP 65 / IP 66 / IP 67 / IP 68 / IP 69K	100	100	150	IIS234
	M30 / L = 60	22 nf	Brass	10...30	IP 65 / IP 66 / IP 67 / IP 68 / IP 69K	100	100	151	IIS236
	M30 / L = 50	15 f	Brass	10...30	IP 65 / IP 66 / IP 67 / IP 68 / IP 69K	100	100	152	IIS246
	M30 / L = 50	22 nf	Brass	10...30	IP 65 / IP 66 / IP 67 / IP 68 / IP 69K	100	100	153	IIS247

















f = flush / nf = non flush

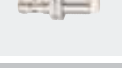













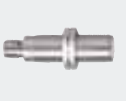

Sensors for oils and coolants with increased sensing range

Type	Dimensions [mm]	Sensing range [mm]	Material	U _b [V]	Protection	f [Hz]	I _{load} [mA]	Draw- ing no.	Order no.
M12 connector · Output function  · 2-wire · DC PNP/NPN · Wiring diagram no. 46 · Connector groups 8, 10, 18, 20									
	M12 / L = 45	4 f	Brass	10...30	IP 68	700	100	1	IFC202
	M18 / L = 46	8 f	Brass	10...30	IP 68	300	100	3	IGC202
	M18 / L = 51	12 nf	Brass	10...30	IP 68	250	100	4	IGC203
M12 connector · Output function  · 2-wire · DC PNP/NPN · Wiring diagram no. 37 · Connector groups 8, 10, 11, 18, 20									
	M12 / L = 45	4 f	Brass	10...30	IP 68	700	100	1	IFC200

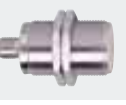







You can find wiring diagrams and scale drawings from page 125

Position sensors

Type	Dimensions [mm]	Sensing range [mm]	Material	U _b [V]	Protection	f [Hz]	I _{load} [mA]	Draw- ing no.	Order no.
M12 connector · Output function  · 2-wire · DC PNP/NPN · Wiring diagram no. 37 · Connector groups 8, 10, 11, 18, 20									
	M12 / L = 50	7 nf	Brass	10...30	IP 68	700	100	2	IFC201
	M18 / L = 46	8 f	Brass	10...30	IP 68	400	100	3	IGC200
	M18 / L = 51	12 nf	Brass	10...30	IP 68	250	100	4	IGC201
M12 connector · Output function  · 3-wire DC PNP · 2-wire DC PNP/NPN · Wiring diagram no. 38 · Connector groups 8, 10, 11, 18, 20									
	M12 / L = 70	4 f	Brass	10...30	IP 68	500	100	5	IFC210
	M18 / L = 70	8 f	Brass	10...30	IP 68	400	100	7	IGC210
M12 connector · Output function  · 3-wire · DC PNP · Wiring diagram no. 1 · Connector groups 8, 10, 18, 20									
	M12 / L = 45	4 f	Brass	10...30	IP 68	700	100	11	IFC204
	M12 / L = 50	7 nf	Brass	10...30	IP 68	700	100	154	IFC205
M12 connector · Output function  · 3-wire · DC PNP · Wiring diagram no. 1 · Connector groups 8, 10, 11, 18, 20									
	M12 / L = 45	4 f	Brass	10...36	IP 68	700	100	1	IFC206
M12 connector · Output function  · 3-wire · DC PNP · Wiring diagram no. 1 · Connector groups 8, 10, 18, 20									
	M12 / L = 60	4 f	Brass	10...30	IP 68	700	200	144	IFC229
	M12 / L = 60	7 nf	Brass	10...30	IP 68	700	200	145	IFC230
M12 connector · Output function  · 3-wire · DC PNP · Wiring diagram no. 1 · Connector groups 8, 10, 18, 20, 120, 124, 126, 128, 157									
	M12 / L = 70	4 f	Brass	10...30	IP 68	700	100	13	IFC237
	M12 / L = 70	7 nf	Brass	10...30	IP 68	700	100	14	IFC238

















Type	Dimensions [mm]	Sensing range [mm]	Material	U _b [V]	Protection	f [Hz]	I _{load} [mA]	Drawing no.	Order no.
M12 connector · Output function  · 3-wire · DC PNP · Wiring diagram no. 1 · Connector groups 8, 10, 11, 18, 20									
	M18 / L = 46	8 f	Brass	10...36	IP 68	400	100	3	IGC204
	M18 / L = 51	12 nf	Brass	10...36	IP 68	300	100	4	IGC205
	M18 / L = 46	8 f	Brass	10...36	IP 68	400	100	3	IGC206
	M18 / L = 60	12 nf	Brass	10...36	IP 68	300	200	117	IGC220
	M18 / L = 60	8 f	Brass	10...36	IP 68	400	200	118	IGC221
	M18 / L = 70	8 f	Brass	10...36	IP 68	400	100	7	IGC224
	M18 / L = 70	12 nf	Brass	10...36	IP 68	300	100	8	IGC225
	M30 / L = 50	15 f	Brass	10...36	IP 68	100	100	155	IIC200
	M30 / L = 50	22 nf	Brass	10...36	IP 68	100	100	156	IIC201
	M30 / L = 60	15 f	Brass	10...36	IP 68	100	200	157	IIC206
	M30 / L = 60	22 nf	Brass	10...36	IP 68	100	200	158	IIC207
	M30 / L = 70	15 f	High-grade st. steel	10...36	IP 68	100	100	9	IIC210
	M30 / L = 70	22 nf	High-grade st. steel	10...36	IP 68	100	100	10	IIC211
	M8 / L = 50	2 f	High-grade st. steel	10...36	IP 67	1000	200	56	IE5381
	M8 / L = 50	4 nf	High-grade st. steel	10...36	IP 67	700	200	159	IE5382

Position sensors



Type	Dimensions [mm]	Sensing range [mm]	Material	U _b [V]	Protection	f [Hz]	I _{load} [mA]	Draw- ing no.	Order no.
M12 connector · Output function  · 3-wire · DC PNP · Wiring diagram no. 2 · Connector groups 8, 10, 18, 20									
	M12 / L = 50	7 nf	Brass	10...30	IP 68	700	100	154	IFC208
M12 connector · Output function  · 3-wire · DC PNP · Wiring diagram no. 2 · Connector group --									
	M12 / L = 45	4 f	Brass	10...30	IP 68	700	100	11	IFC207
M12 connector · Output function  · 3-wire · DC PNP · Wiring diagram no. 2 · Connector groups 8, 10, 18, 20									
	M12 / L = 45	4 f	Brass	10...36	IP 68	700	100	1	IFC209
	M18 / L = 46	8 f	Brass	10...36	IP 68	400	100	3	IGC207
	M18 / L = 51	12 nf	Brass	10...36	IP 68	300	100	4	IGC208
	M18 / L = 46	8 f	Brass	10...36	IP 68	400	100	3	IGC209
M12 connector · Output function  /  · 2-wire · DC PNP/NPN · Wiring diagram no. 39 · Connector groups 8, 10, 18, 20									
	M12 / L = 60	4 f	Brass	10...36	IP 68	700	100	160	IFC234
	M12 / L = 60	7 nf	Brass	10...36	IP 68	500	100	161	IFC235
	M18 / L = 70	8 f	Brass	10...30	IP 68	400	100	7	IGC222
	M18 / L = 70	12 nf	Brass	10...36	IP 68	300	100	8	IGC223
	M30 / L = 70	15 f	Brass	10...30	IP 68	100	100	9	IIC208
	M30 / L = 70	22 nf	Brass	10...30	IP 68	100	100	10	IIC209

f = flush / nf = non flush

Sensors for oils and coolants, threaded housings







Type	Dimensions [mm]	Sensing range [mm]	Material	U _b [V]	Protection	f [Hz]	I _{load} [mA]	Drawing no.	Order no.
Cable 0.8 m · with M12 connector · Output function  · 2-wire · DC PNP/NPN · Wiring diagram no. 23 · Connector groups 8, 10, 18, 20									
	M8 / L = 42	2 f	Brass	10...55	IP 67	1000	100	162	IE9902
	M18 / L = 58	5 f	Brass	10...55	IP 67	700	400	163	IG9984
Cable 0.8 m · with M12 connector · Output function  · 2-wire · DC PNP/NPN · Wiring diagram no. 47 · Connector groups 8, 10, 18, 20									
	M12 / L = 54	2 f	Brass	10...55	IP 67	800	100	164	IF9920
Cable 2 m · Output function  · 2-wire · DC PNP/NPN · Wiring diagram no. 24									
	M18 / L = 54	5 f	Brass	10...55	IP 67	700	400	165	IG5682
Cable 2 m · Output function  · 2-wire · DC PNP/NPN · Wiring diagram no. 48									
	M8 / L = 42	2 f	Brass	10...55	IP 67	1000	100	166	IE9203
	M12 / L = 54	2 f	Brass	10...55	IP 67	800	100	167	IF9222
M12 connector · Output function  · 2-wire · DC PNP/NPN · Wiring diagram no. 23 · Connector groups 8, 10, 18, 20									
	M8 / L = 69	1 f	Brass	5...36	IP 65	2000	200	58	IE9940
	M12 / L = 60	2 f	Brass	10...55	IP 67	800	100	168	IF9924
	M18 / L = 65	5 f	Brass	10...55	IP 67	700	400	169	IG9983
M12 connector · Output function  · 3-wire · DC PNP · Wiring diagram no. 1 · Connector groups 8, 10, 11, 18, 20									
	M12 / L = 45	2 f	Brass	10...36	IP 68	700	200	1	IFC239
	M12 / L = 70	2 f	Brass	10...36	IP 68	700	200	5	IFC241

Position sensors

Type	Dimensions [mm]	Sensing range [mm]	Material	U _b [V]	Protection	f [Hz]	I _{load} [mA]	Drawing no.	Order no.
M12 connector · Output function  · 3-wire · DC PNP · Wiring diagram no. 1 · Connector groups 8, 10, 11, 18, 20									
	M12 / L = 60	2 f	Brass	10...36	IP 68	700	200	160	IFC243
	M30 / L = 50	15 nf	High-grade st. steel	10...36	IP 68	100	200	156	IIC213

f = flush / nf = non flush

Sensors for oils and coolants, rectangular housings





Type	Dimensions [mm]	Sensing range [mm]	Material	U _b [V]	Protection	f [Hz]	I _{load} [mA]	Drawing no.	Order no.
Cable 0.15 m · with M12 connector · Output function  · 2-wire · DC PNP/NPN · Wiring diagram no. 23 · Connector groups 8, 10, 18, 20									
	26 x 26 x 26	10 f	polyamide	10...36	IP 67	250	100	170	IO5018
Cable 0.8 m · with M12 connector · Output function  · 2-wire · DC PNP/NPN · Wiring diagram no. 23 · Connector groups 8, 10, 18, 20									
	26 x 26 x 26	10 f	polyamide	10...36	IP 67	250	100	170	IO5017
Cable 0.8 m · with M12 connector · Output function  · 2-wire · DC PNP/NPN · Wiring diagram no. 47 · Connector groups 8, 10, 18, 20									
	40 x 40 x 54	15 f	PA (polyamide)	10...36	IP 67	200	100	171	IM5138
Cable 0.8 m · with M12 connector · Output function  · 2-wire · DC PNP/NPN · Wiring diagram no. 49 · Connector groups 8, 10, 18, 20									
	40 x 40 x 54	15 f	PA (polyamide)	10...36	IP 67	200	100	171	IM5137
M12 connector · Output function  · 2-wire · DC PNP/NPN · Wiring diagram no. 23 · Connector groups 8, 10, 18, 20									
	26 x 26 x 43	10 f	polyamide	10...36	IP 67	250	100	172	IO5016
M12 connector · Output function  · 2-wire · DC PNP/NPN · Wiring diagram no. 47 · Connector groups 8, 10, 18, 20									
	40 x 40 x 54	15 f	PA (polyamide)	10...36	IP 67	200	100	173	IM5127

f = flush / nf = non flush

Sensors for oils and coolants with correction factor K = 1

Type	Dimensions [mm]	Sensing range [mm]	Material	U _b [V]	Protection	f [Hz]	I _{load} [mA]	Drawing no.	Order no.
------	--------------------	-----------------------	----------	-----------------------	------------	-----------	---------------------------	-------------	-----------

M12 connector · Output function  · 3-wire · DC PNP · Wiring diagram no. 1 · Connector groups 8, 10, 11, 18, 20

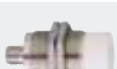
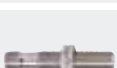
	M12 / L = 65	8 nf	High-grade st. steel	10...30	IP 68	2000	200	174	IFC246
	M18 / L = 65	5 f	High-grade st. steel	10...30	IP 68	2000	200	175	IGC232
	M18 / L = 65	12 nf	High-grade st. steel	10...30	IP 68	2000	200	176	IGC233
	M30 / L = 65	10 f	High-grade st. steel	10...30	IP 68	1000	200	177	IIC218
	M30 / L = 65	22 nf	High-grade st. steel	10...30	IP 68	1000	200	178	IIC219
	M12 / L = 65	3 f	Brass	10...30	IP 68	2000	200	179	IFC259

M8 connector · Output function  · 3-wire · DC PNP · Wiring diagram no. 1 · Connector groups 1, 2, 3



	M8 / L = 65	1.5 f	High-grade st. steel	10...30	IP 67	1000	200	180	IE5390
	M8 / L = 65	4 nf	High-grade st. steel	10...30	IP 67	1000	200	181	IE5391

f = flush / nf = non flush







Sensors for oils and coolants with ceramic sensing face

Type	Dimensions [mm]	Sensing range [mm]	Material	U _b [V]	Protection	f [Hz]	I _{load} [mA]	Drawing no.	Order no.
------	--------------------	-----------------------	----------	-----------------------	------------	-----------	---------------------------	-------------	-----------

M12 connector · Output function  · 3-wire DC PNP · 2-wire DC PNP/NPN · Wiring diagram no. 38 · Connector groups 8, 10, 11, 18, 20

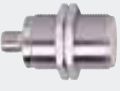



	M12 / L = 70	4 f	Brass	10...30	IP 68	500	100	5	IFC210
	M18 / L = 70	8 f	Brass	10...30	IP 68	400	100	7	IGC210

Position sensors

Type	Dimensions [mm]	Sensing range [mm]	Material	U _b [V]	Protection	f [Hz]	I _{load} [mA]	Draw- ing no.	Order no.
M12 connector · Output function  · 3-wire · DC PNP · Wiring diagram no. 1 · Connector groups 8, 10, 11, 18, 20									
	M12 / L = 45	4 f	Brass	10...36	IP 68	700	100	1	IFC206
	M30 / L = 60	15 f	Brass	10...36	IP 68	100	200	157	IIC206
M12 connector · Output function  · 3-wire · DC PNP · Wiring diagram no. 2 · Connector groups 8, 10, 18, 20									
	M12 / L = 45	4 f	Brass	10...36	IP 68	700	100	1	IFC209
	M18 / L = 46	8 f	Brass	10...36	IP 68	400	100	3	IGC209

f = flush / nf = non flush

Sensors for oils and coolants, AS-i system



Type	Dimensions [mm]	Sensing range [mm]	Material	U _b [V]	Protection	f [Hz]	I _{load} [mA]	Draw- ing no.	Order no.
M12 connector · 2-wire · AS-i · Wiring diagram no. 9 · Connector groups 8, 10, 18, 20									
	M12 / L = 60	4 f	High-grade st. steel	26.5...31.6	IP 68	100	–	160	IFC247
	M18 / L = 60	8 f	High-grade st. steel	26.5...31.6	IP 68	100	–	118	IGC234
	M18 / L = 60	12 nf	High-grade st. steel	26.5...31.6	IP 68	100	–	117	IGC235
	M30 / L = 60	14 f	High-grade st. steel	26.5...31.6	IP 68	100	–	157	IIC220
	M30 / L = 60	22 nf	High-grade st. steel	26.5...31.6	IP 68	100	–	158	IIC221

f = flush / nf = non flush

Electromagnetic field immune sensors with correction factor K = 1











Type	Dimensions [mm]	Sensing range [mm]	Material	U _b [V]	Protection	f [Hz]	I _{load} [mA]	Drawing no.	Order no.
M12 connector · Output function  · 3-wire · DC PNP · Wiring diagram no. 1 · Connector groups 114, 115, 116, 117									
	M12 / L = 65	3 f	Brass	10...30	IP 67	4000	200	182	IFW200
	M12 / L = 65	8 nf	Brass	10...30	IP 67	4000	200	183	IFW201
	M18 / L = 65	5 f	Brass	10...30	IP 67	2000	200	175	IGW200
	M18 / L = 65	12 nf	Brass	10...30	IP 67	2000	200	176	IGW201
	M30 / L = 65	10 f	Brass	10...30	IP 67	1000	200	177	IIW200
	M30 / L = 65	22 nf	Brass	10...30	IP 67	1000	200	184	IIW201
	40 x 40 x 54	20 f	PA (polyamide)	10...36	IP 67	200	200	101	IM5119
	40 x 40 x 54	35 nf	PA (polyamide)	10...36	IP 67	200	200	101	IM5120
	40 x 40 x 54	40 nf	PA (polyamide)	10...36	IP 67	200	200	101	IM5129
M12 connector · Output function  · 4-wire · DC PNP · Wiring diagram no. 10 · Connector groups 114, 115, 116, 117									
	40 x 40 x 54	20 f	PA (polyamide)	10...36	IP 67	200	200	101	IM5124
	40 x 40 x 54	35 nf	PA (polyamide)	10...36	IP 67	200	200	101	IM5125
	40 x 40 x 54	40 nf	PA (polyamide)	10...36	IP 67	200	200	101	IM5126
	40 x 40 x 54	20 f	PA (polyamide)	10...36	IP 67	200	200	99	IM5132

Position sensors

Type	Dimensions [mm]	Sensing range [mm]	Material	U _b [V]	Protection	f [Hz]	I _{load} [mA]	Drawing no.	Order no.
M12 connector · Output function  · 4-wire · DC PNP · Wiring diagram no. 10 · Connector groups 8, 9, 10, 11, 18, 20, 120, 124, 126, 128, 130, 131, 157, 158									
	40 x 40 x 54	35 nf	PA (polyamide)	10...36	IP 67	200	200	99	IM5133
	40 x 40 x 54	40 nf	PA (polyamide)	10...36	IP 67 / IP 69K	200	200	99	IM5135

f = flush / nf = non flush

Electromagnetic field immune sensors

Type	Dimensions [mm]	Sensing range [mm]	Material	U _b [V]	Protection	f [Hz]	I _{load} [mA]	Drawing no.	Order no.
M12 connector · Output function  · 3-wire · DC PNP · Wiring diagram no. 1 · Connector groups 114, 115, 116, 117									
	M12 / L = 60	4 nf	Brass	10...36	IP 67	1000	250	185	IF5675
	M18 / L = 60	5 f	Brass	10...36	IP 67	700	250	118	IG5647
	M12 / L = 60	2 f	Brass	10...36	IP 67	1000	250	186	IF5670
	M12 / L = 60	2 f	Brass	10...36	IP 67	1000	250	186	IF5750
	M12 / L = 60	4 nf	Brass	10...36	IP 67	1000	250	185	IF5751
	M18 / L = 60	5 f	Brass	10...36	IP 67	700	250	118	IG5667
	M30 / L = 60	10 f	Brass	10...36	IP 67	250	250	187	II5503
	40 x 40 x 118	15 f	modified PPE	10...60	IP 67	50	200	188	IV5025
M12 connector · Output function  · 4-wire · DC PNP · Wiring diagram no. 10 · Connector groups 114, 115, 116, 117									
	92 x 80 x 40	50 f	PPE	10...36	IP 67	70	250	100	ID5059

f = flush / nf = non flush

Full metal sensors for oils and coolants

Type	Dimensions [mm]	Sensing range [mm]	Material	U _b [V]	Protection	f [Hz]	I _{load} [mA]	Draw- ing no.	Order no.
------	--------------------	--------------------------	----------	-----------------------	------------	-----------	---------------------------	---------------------	--------------

M12 connector · Output function  · 3-wire · DC NPN · Wiring diagram no. 21 · Connector groups 8, 10, 18, 20

	M8 / L = 60	2 f	High-grade st. steel	10...36	IP 67 / IP 68	100	100	189	IEC203
	M12 / L = 60	3 f	High-grade st. steel	10...36	IP 67 / IP 68	100	100	160	IFC266
	M18 / L = 70	5 f	High-grade st. steel	10...36	IP 67 / IP 68	100	100	61	IGC252
	M30 / L = 70	10 f	High-grade st. steel	10...36	IP 67 / IP 68	50	100	190	IIC226

M12 connector · Output function  · 3-wire · DC PNP · Wiring diagram no. 1 · Connector groups 8, 10, 11, 18, 20

	M12 / L = 60	3 f	High-grade st. steel	10...36	IP 67 / IP 68	100	100	160	IFC258
	M18 / L = 70	5 f	High-grade st. steel	10...36	IP 67 / IP 68	100	100	61	IGC248
	M30 / L = 70	10 f	High-grade st. steel	10...36	IP 67 / IP 68	50	100	190	IIC224
	M8 / L = 60	2 f	High-grade st. steel	10...36	IP 67 / IP 68 / IP 69K	100	100	189	IEC200

M8 connector · Output function  · 3-wire · DC NPN · Wiring diagram no. 21 · Connector groups 1, 3







	M8 / L = 50	2 f	High-grade st. steel	10...36	IP 67	100	100	191	IEC202
---	-------------	-----	----------------------	---------	-------	-----	-----	-----	--------

M8 connector · Output function  · 3-wire · DC PNP · Wiring diagram no. 1 · Connector groups 1, 2, 3

	M8 / L = 50	2 f	High-grade st. steel	10...36	IP 67	100	100	191	IEC201
---	-------------	-----	----------------------	---------	-------	-----	-----	-----	--------







f = flush / nf = non flush

Full metal sensors for oils and coolants with correction factor K = 0

Type	Dimensions [mm]	Sensing range [mm]	Material	U _b [V]	Protection	f [Hz]	I _{load} [mA]	Drawing no.	Order no.
M12 connector · Output function  · 3-wire · DC PNP · Wiring diagram no. 1 · Connector groups 8, 10, 11, 18, 20									
	M12 / L = 60	2.5 f	High-grade st. steel	10...36	IP 68	100	100	160	IFC263
	M18 / L = 70	4.5 f	High-grade st. steel	10...36	IP 68	100	100	192	IGC249
M12 connector · Output function  · 3-wire · DC PNP · Wiring diagram no. 2 · Connector groups 8, 10, 18, 20									
	M12 / L = 60	2.5 f	High-grade st. steel	10...36	IP 68	100	100	160	IFC264
	M18 / L = 70	4.5 f	High-grade st. steel	10...36	IP 68	100	100	192	IGC250

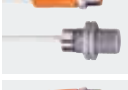
f = flush / nf = non flush

Full metal sensors with non-stick coating against weld spatter

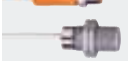
Type	Dimensions [mm]	Sensing range [mm]	Material	U _b [V]	Protection	f [Hz]	I _{load} [mA]	Drawing no.	Order no.
Cable 0.3 m · with M12 connector · Output function  · 2-wire · DC PNP/NPN · Wiring diagram no. 23 · Connector groups 114, 116, 117									
	M8 / L = 45	2 f	High-grade st. steel	10...36	IP 67	150	100	193	IER203
	M12 / L = 40	4 f	High-grade st. steel	10...36	IP 67	75	100	194	IFR203
	M18 / L = 40	6 f	High-grade st. steel	10...36	IP 67	50	100	195	IGR203
	M30 / L = 40	12 f	High-grade st. steel	10...36	IP 67	25	100	196	IIR203
Cable 0.3 m · with M12 connector · Output function  · 2-wire · DC PNP/NPN · Wiring diagram no. 25 · Connector groups 114, 116, 117									
	M8 / L = 45	2 f	High-grade st. steel	10...36	IP 67	150	100	193	IER206
	M12 / L = 40	4 f	High-grade st. steel	10...36	IP 67	75	100	194	IFR206
	M18 / L = 40	6 f	High-grade st. steel	10...36	IP 67	50	100	195	IGR206

Product selectors and further information can be found at: www.ifm.com

Type	Dimensions [mm]	Sensing range [mm]	Material	U _b [V]	Protection	f [Hz]	I _{load} [mA]	Drawing no.	Order no.
------	--------------------	--------------------------	----------	-----------------------	------------	-----------	---------------------------	----------------	--------------

Cable 0.3 m · with M12 connector · Output function  · 2-wire · DC PNP/NPN · Wiring diagram no. 25 · Connector groups 114, 116, 117



M30 / L = 40	12 f	High-grade st. steel	10...36	IP 67	25	100	196	IIR206
--------------	------	----------------------	---------	-------	----	-----	-----	---------------

Cable 3 m · Output function  · 2-wire · DC PNP/NPN · Wiring diagram no. 26



M8 / L = 45	2 f	High-grade st. steel	10...36	IP 67	150	100	197	IER204
-------------	-----	----------------------	---------	-------	-----	-----	-----	---------------

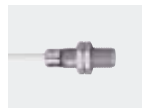

M12 / L = 40	4 f	High-grade st. steel	10...36	IP 67	75	100	198	IFR204
--------------	-----	----------------------	---------	-------	----	-----	-----	---------------



M18 / L = 40	6 f	High-grade st. steel	10...36	IP 67	50	100	199	IGR204
--------------	-----	----------------------	---------	-------	----	-----	-----	---------------



M30 / L = 40	12 f	High-grade st. steel	10...36	IP 67	25	100	200	IIR204
--------------	------	----------------------	---------	-------	----	-----	-----	---------------

Cable 5 m · Output function  · 2-wire · DC PNP/NPN · Wiring diagram no. 26



M8 / L = 45	2 f	High-grade st. steel	10...36	IP 67	150	100	197	IER205
-------------	-----	----------------------	---------	-------	-----	-----	-----	---------------

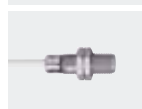

M12 / L = 40	4 f	High-grade st. steel	10...36	IP 67	75	100	198	IFR205
--------------	-----	----------------------	---------	-------	----	-----	-----	---------------

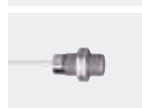

M18 / L = 40	6 f	High-grade st. steel	10...36	IP 67	50	100	199	IGR205
--------------	-----	----------------------	---------	-------	----	-----	-----	---------------



M30 / L = 40	12 f	High-grade st. steel	10...36	IP 67	25	100	200	IIR205
--------------	------	----------------------	---------	-------	----	-----	-----	---------------

M12 connector · Output function  · 3-wire · DC NPN · Wiring diagram no. 21 · Connector groups 114, 116, 117



M8 / L = 60	2 f	High-grade st. steel	10...36	IP 67 / IP 68	100	100	189	IER201
-------------	-----	----------------------	---------	---------------	-----	-----	-----	---------------



M12 / L = 60	4 f	High-grade st. steel	10...36	IP 67	2	100	160	IFR202
--------------	-----	----------------------	---------	-------	---	-----	-----	---------------







M18 / L = 70	6 f	High-grade st. steel	10...36	IP 67	2	100	61	IGR202
--------------	-----	----------------------	---------	-------	---	-----	----	---------------













M30 / L = 70	12 f	High-grade st. steel	10...36	IP 67	2	100	190	IIR202
--------------	------	----------------------	---------	-------	---	-----	-----	---------------

Position sensors

Type	Dimensions [mm]	Sensing range [mm]	Material	U _b [V]	Protection	f [Hz]	I _{load} [mA]	Drawing no.	Order no.
M12 connector · Output function  · 3-wire · DC PNP · Wiring diagram no. 1 · Connector groups 114, 115, 116, 117									
	M8 / L = 60	2 f	High-grade st. steel	10...36	IP 67 / IP 68	100	100	189	IER200
	M12 / L = 60	4 f	High-grade st. steel	10...36	IP 67	2	100	160	IFR200
	M18 / L = 70	6 f	High-grade st. steel	10...36	IP 67	2	100	61	IGR200
	M30 / L = 70	12 f	High-grade st. steel	10...36	IP 67	2	100	190	IIR200

f = flush / nf = non flush

Full metal sensors for hygienic and wet areas

Type	Dimensions [mm]	Sensing range [mm]	Material	U _b [V]	Protection	f [Hz]	I _{load} [mA]	Drawing no.	Order no.
M12 connector · Output function  · 3-wire · DC NPN · Wiring diagram no. 21 · Connector groups 120, 122, 124, 126, 132									
	M12 / L = 70	6 nf	High-grade st. steel	10...36	IP 65 / IP 67 / IP 68 / IP 69K	500	100	201	IFT246
	M18 / L = 70	12 nf	High-grade st. steel	10...36	IP 65 / IP 67 / IP 68 / IP 69K	500	100	202	IGT250
	M30 / L = 70	25 nf	High-grade st. steel	10...36	IP 65 / IP 67 / IP 68 / IP 69K	250	100	203	IIT232
M12 connector · Output function  · 3-wire · DC NPN · Wiring diagram no. 21 · Connector groups 120, 124, 126									
	M18 / L = 70	5 f	High-grade st. steel	10...36	IP 68 / IP 69K	100	100	61	IGT248
	M12 / L = 60	3 f	High-grade st. steel	10...36	IP 68 / IP 69K	100	100	160	IFT244
	M30 / L = 70	10 f	High-grade st. steel	10...36	IP 68 / IP 69K	50	100	190	IIT230
M12 connector · Output function  · 3-wire · DC PNP · Wiring diagram no. 1 · Connector groups 120, 122, 124, 126, 130, 132									
	M12 / L = 70	6 nf	High-grade st. steel	10...36	IP 65 / IP 67 / IP 68 / IP 69K	500	100	201	IFT245

Type	Dimensions [mm]	Sensing range [mm]	Material	U _b [V]	Protection	f [Hz]	I _{load} [mA]	Draw- ing no.	Order no.
------	--------------------	--------------------------	----------	-----------------------	------------	-----------	---------------------------	---------------------	--------------

M12 connector · Output function  · 3-wire · DC PNP · Wiring diagram no. 1 · Connector groups 120, 122, 124, 126, 130, 132

	M18 / L = 70	12 nf	High-grade st. steel	10...36	IP 65 / IP 67 / IP 68 / IP 69K	500	100	202	IGT249
	M30 / L = 70	25 nf	High-grade st. steel	10...36	IP 65 / IP 67 / IP 68 / IP 69K	250	100	203	IIT231

M12 connector · Output function  · 3-wire · DC PNP · Wiring diagram no. 1 · Connector groups 120, 124, 126, 130

	M18 / L = 70	5 f	High-grade st. steel	10...36	IP 68 / IP 69K	100	100	61	IGT247
	M30 / L = 70	10 f	High-grade st. steel	10...36	IP 68 / IP 69K	50	100	190	IIT228
	M12 / L = 60	3 f	High-grade st. steel	10...36	IP 68 / IP 69K	100	100	160	IFT240
	∅ 12 / L = 60	3 f	High-grade st. steel	10...36	IP 68 / IP 69K	100	100	204	IFT243

f = flush / nf = non flush

Sensors for hygienic and wet areas with increased sensing range

Type	Dimensions [mm]	Sensing range [mm]	Material	U _b [V]	Protection	f [Hz]	I _{load} [mA]	Draw- ing no.	Order no.
------	--------------------	--------------------------	----------	-----------------------	------------	-----------	---------------------------	---------------------	--------------

















1/2" UNF-Connector · Output function  · 2-wire · AC/DC · Wiring diagram no. 27 · Connector group 29

	M30 / L = 70	22 nf	High-grade st. steel	20...140	IP 68 / IP 69K	25 / 100	80	205	IIT002
---	--------------	-------	----------------------	----------	----------------	----------	----	-----	---------------

Cable 10 m · Output function  · 3-wire · DC PNP · Wiring diagram no. 4





	M12 / L = 50	4 f	High-grade st. steel	10...36	IP 68 / IP 69K	800	100	206	IFT207
	M12 / L = 61	7 nf	High-grade st. steel	10...36	IP 68 / IP 69K	800	100	207	IFT209
	M18 / L = 57	8 f	High-grade st. steel	10...36	IP 68 / IP 69K	600	100	208	IGT207
	M18 / L = 62	12 nf	High-grade st. steel	10...36	IP 68 / IP 69K	300	100	209	IGT209

Position sensors

Type	Dimensions [mm]	Sensing range [mm]	Material	U _b [V]	Protection	f [Hz]	I _{load} [mA]	Drawing no.	Order no.
Cable 10 m · Output function  · 3-wire · DC PNP · Wiring diagram no. 4									
	M30 / L = 59	14 f	High-grade st. steel	10...36	IP 68 / IP 69K	100	100	210	IIT206
	M30 / L = 59	22 nf	High-grade st. steel	10...36	IP 68 / IP 69K	100	100	211	IIT208
Cable 6 m · Output function  · 3-wire · DC PNP · Wiring diagram no. 4									
	M12 / L = 50	4 f	High-grade st. steel	10...36	IP 68 / IP 69K	800	100	206	IFT206
	M12 / L = 61	7 nf	High-grade st. steel	10...36	IP 68 / IP 69K	800	100	207	IFT208
	M18 / L = 57	8 f	High-grade st. steel	10...36	IP 68 / IP 69K	600	100	208	IGT206
	M18 / L = 62	12 nf	High-grade st. steel	10...36	IP 68 / IP 69K	300	100	209	IGT208
	M30 / L = 59	22 nf	High-grade st. steel	10...36	IP 68 / IP 69K	100	100	211	IIT207
	M30 / L = 59	14 f	High-grade st. steel	10...36	IP 68 / IP 69K	100	100	210	IIT209
M12 connector · Output function  · 3-wire DC PNP · 2-wire DC PNP/NPN · Wiring diagram no. 38 · Connector groups 120, 124, 126, 130									
	M12 / L = 70	7 nf	High-grade st. steel	10...30	IP 68 / IP 69K	700	100	212	IFT202
	M12 / L = 70	4 f	High-grade st. steel	10...36	IP 68 / IP 69K	500	100	5	IFT205
	Ø 12 / L = 70	7 nf	High-grade st. steel	10...30	IP 68 / IP 69K	700	100	213	IFT210
	M18 / L = 70	12 nf	High-grade st. steel	10...30	IP 68 / IP 69K	300	100	214	IGT202
	M18 / L = 70	8 f	High-grade st. steel	10...36	IP 68 / IP 69K	400	100	7	IGT205
	M30 / L = 70	22 nf	High-grade st. steel	10...36	IP 68 / IP 69K	100	100	10	IIT202











Type	Dimensions [mm]	Sensing range [mm]	Material	U _b [V]	Protection	f [Hz]	I _{load} [mA]	Draw- ing no.	Order no.
M12 connector · Output function  · 3-wire DC PNP · 2-wire DC PNP/NPN · Wiring diagram no. 38 · Connector groups 120, 124, 126, 130									
	M30 / L = 70	14 f	High-grade st. steel	10...36	IP 68 / IP 69K	100	100	9	IIT204
M12 connector · Output function  · 3-wire · DC PNP · Wiring diagram no. 1 · Connector groups 120, 124, 126, 130									
	M12 / L = 50	7 nf	High-grade st. steel	10...36	IP 68 / IP 69K	800	100	215	IFT200
	M12 / L = 45	4 f	High-grade st. steel	10...36	IP 68 / IP 69K	800	100	1	IFT203
	M12 / L = 70	4 f	High-grade st. steel	10...36	IP 68 / IP 69K	700	100	5	IFT216
	M12 / L = 70	7 nf	High-grade st. steel	10...36	IP 68 / IP 69K	800	100	6	IFT217
	M18 / L = 51	12 nf	High-grade st. steel	10...36	IP 68 / IP 69K	300	100	216	IGT200
	M18 / L = 46	8 f	High-grade st. steel	10...36	IP 68 / IP 69K	600	100	3	IGT203
	M18 / L = 70	8 f	High-grade st. steel	10...36	IP 68 / IP 69K	400	100	7	IGT219
	M18 / L = 70	12 nf	High-grade st. steel	10...36	IP 68 / IP 69K	300	100	8	IGT220
	M30 / L = 50	22 nf	High-grade st. steel	10...36	IP 68 / IP 69K	100	100	217	IIT200
	M30 / L = 50	14 f	High-grade st. steel	10...36	IP 68 / IP 69K	100	100	155	IIT205
	M30 / L = 70	15 f	High-grade st. steel	10...36	IP 68 / IP 69K	100	100	9	IIT212
	M30 / L = 70	22 nf	High-grade st. steel	10...36	IP 68 / IP 69K	100	100	10	IIT213















Position sensors

Type	Dimensions [mm]	Sensing range [mm]	Material	U _b [V]	Protection	f [Hz]	I _{load} [mA]	Drawing no.	Order no.
M12 connector · Output function  · 3-wire · DC PNP · Wiring diagram no. 2 · Connector groups 120, 124, 126									
	M18 / L = 46	8 f	High-grade st. steel	10...36	IP 68 / IP 69K	600	100	3	IGT204
	M12 / L = 50	7 nf	High-grade st. steel	10...36	IP 68 / IP 69K	800	100	215	IFT201
	M12 / L = 45	4 f	High-grade st. steel	10...36	IP 68 / IP 69K	800	100	1	IFT204
	M18 / L = 51	12 nf	High-grade st. steel	10...36	IP 68 / IP 69K	300	100	216	IGT201

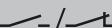
f = flush / nf = non flush

Sensors for hygienic and wet areas

Type	Dimensions [mm]	Sensing range [mm]	Material	U _b [V]	Protection	f [Hz]	I _{load} [mA]	Drawing no.	Order no.
Cable 2 m · Output function  · 4-wire · DC PNP · Wiring diagram no. 28									
	M18 / L = 80	8 nf	High-grade st. steel	10...36	IP 67	320	250	44	IG5202
M12 connector · Output function  · 3-wire DC PNP · 2-wire DC PNP/NPN · Wiring diagram no. 38 · Connector groups 120, 124, 126, 130									
	M18 / L = 70	8 nf	High-grade st. steel	10...36	IP 68 / IP 69K	300	100	214	IGT240
M12 connector · Output function  · 3-wire · DC PNP · Wiring diagram no. 1 · Connector groups 120, 124, 126, 130									
	M8 / L = 70	1 f	High-grade st. steel	10...36	IP 67	2000	200	218	IE5215
	M8 / L = 55	2 nf	High-grade st. steel	10...36	IP 67	2000	200	219	IE5295
	M12 / L = 59	2 f	High-grade st. steel	10...36	IP 67	1100	200	220	IF5514
	M12 / L = 83	4 nf	High-grade st. steel	10...36	IP 67	400	250	60	IF5594
	M12 / L = 44	4 nf	High-grade st. steel	10...36	IP 67	1400	125	221	IF5796

Type	Dimensions [mm]	Sensing range [mm]	Material	U _b [V]	Protection	f [Hz]	I _{load} [mA]	Draw- ing no.	Order no.
M12 connector · Output function  · 3-wire · DC PNP · Wiring diagram no. 1 · Connector groups 120, 124, 126, 130									
	M12 / L = 59	4 nf	High-grade st. steel	10...36	IP 67	1400	250	222	IF5813
	M12 / L = 44	2 f	High-grade st. steel	10...36	IP 67	1200	250	223	IF5815
	M12 / L = 83	2 f	High-grade st. steel	10...36	IP 67	800	250	59	IF5851
	M18 / L = 90	8 nf	High-grade st. steel	10...36	IP 67	300	250	224	IG5602
	M18 / L = 76	5 f	High-grade st. steel	10...36	IP 67	500	250	225	IG5813
	M30 / L = 92	10 f	High-grade st. steel	10...36	IP 67	250	250	226	I15689
	M30 / L = 92	15 nf	High-grade st. steel	10...36	IP 67	200	250	227	I15776
M12 connector · Output function  · 2-wire · DC PNP/NPN · Wiring diagram no. 39 · Connector groups 120, 124, 126									
	M12 / L = 83	2 f	High-grade st. steel	10...55	IP 67	1100	400	59	IF5759
	M12 / L = 83	4 nf	High-grade st. steel	10...55	IP 67	1500	300	60	IF5760
	M18 / L = 77	8 nf	High-grade st. steel	10...55	IP 67	300	300	228	IG5772
	M18 / L = 90	5 f	High-grade st. steel	10...55	IP 67	700	400	229	IG5806
	M30 / L = 78	15 nf	High-grade st. steel	10...55	IP 67	200	400	64	I15733
	M30 / L = 92	10 f	High-grade st. steel	10...55	IP 67	450	400	226	I15751

Position sensors

Type	Dimensions [mm]	Sensing range [mm]	Material	U _b [V]	Protection	f [Hz]	I _{load} [mA]	Drawing no.	Order no.
------	--------------------	-----------------------	----------	-----------------------	------------	-----------	---------------------------	-------------	-----------

M12 connector · Output function  · 4-wire · DC PNP · Wiring diagram no. 10 · Connector groups 120, 124, 126, 130







M18 / L = 45	10 nf	High-grade st. steel	10...36	IP 67	300	250	230	IG5846
--------------	-------	----------------------	---------	-------	-----	-----	-----	---------------



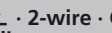

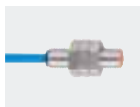
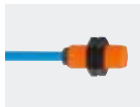
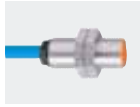
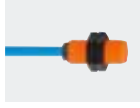
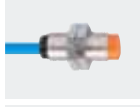
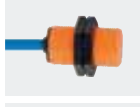
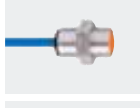
f = flush / nf = non flush

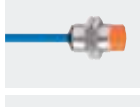
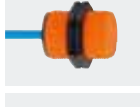
Sensors with ATEX approval 1D / 2G

Type	Dimensions [mm]	Sensing range [mm]	Material	U _{nom.} at 1 K Ω [V]	U _b [V]	Internal capacit. [nF]	Internal inductance [μ H]	f [Hz]	Drawing no.	Order no.
------	--------------------	-----------------------	----------	---	-----------------------	---------------------------	-----------------------------------	-----------	-------------	-----------

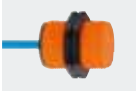
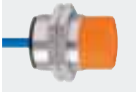



Cable 2 m · Output function  · 2-wire · Connection to certified intrinsically safe circuits with the max. values U = 15 V / I = 50 mA / P = 120 mW · Wiring diagram no. 29

	M8 / L = 30	1 f	Brass	8.2 DC	7.5...30	80	70	2000	231	NE5001
	M12 / L = 30	2 f	PBT	8.2 DC	7.5...30	140	340	1200	232	NF5001
	M12 / L = 30	2 f	Brass	8.2 DC	7.5...30	140	340	1200	232	NF5002
	M12 / L = 30	4 nf	PBT	8.2 DC	7.5...30	140	130	1500	232	NF5003
	M12 / L = 30	4 nf	Brass	8.2 DC	7.5...30	140	130	1500	233	NF5004
	M18 / L = 33	5 f	PBT	8.2 DC	7.5...30	145	45	720	234	NG5001
	M18 / L = 33	5 f	Brass	8.2 DC	7.5...30	145	45	720	234	NG5002
	M18 / L = 33	8 nf	PBT	8.2 DC	7.5...30	155	50	300	234	NG5003
	M18 / L = 33	8 nf	Brass	8.2 DC	7.5...30	155	50	300	235	NG5004
	M30 / L = 41	10 f	PBT	8.2 DC	7.5...30	145	140	450	236	NI5001
	M30 / L = 41	10 f	Brass	8.2 DC	7.5...30	145	140	450	236	NI5002

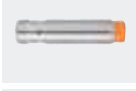
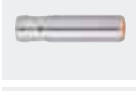

Type	Dimensions [mm]	Sensing range [mm]	Material	U _{nom.} at 1 KΩ [V]	U _b [V]	Internal capacit. [nF]	Internal inductance [μH]	f [Hz]	Draw- ing no.	Order no.
Cable 2 m · Output function  · 2-wire · Connection to certified intrinsically safe circuits with the max. values U = 15 V / I = 50 mA / P = 120 mW · Wiring diagram no. 29										
	M30 / L = 41	15 nf	PBT	8.2 DC	7.5...30	145	110	200	236	NI5003
	M30 / L = 41	15 nf	Brass	8.2 DC	7.5...30	145	110	200	237	NI5004
	40 x 12 x 26	4 nf	PBT	8.2 DC	7.5...30	110	135	400	238	NN5002
	28 x 10 x 16	2 f	PBT	8.2 DC	7.5...30	80	110	800	239	NS5002
	∅ 6.5 / L = 30	1 f	Brass	8.2 DC	7.5...30	80	70	2000	240	NT5001

f = flush / nf = non flush

Sensors with ATEX approval 1D / 1G / 2G









Type	Dimensions [mm]	Sensing range [mm]	Material	U _{nom.} at 1 KΩ [V]	U _b [V]	Internal capacit. [nF]	Internal inductance [μH]	f [Hz]	Draw- ing no.	Order no.
M12 connector · Output function  · 2-wire · Connection to certified intrinsically safe circuits with the max. values U = 15 V / I = 50 mA / P = 120 mW · Wiring diagram no. 30 · Connector groups 153, 155										
	M12 / L = 50	7 nf	Brass	8.2 DC	7.5...30	210	145	700	2	NF500A
	M12 / L = 45	4 f	Brass	8.2 DC	7.5...30	210	115	700	1	NF501A
	M18 / L = 51	12 nf	Brass	8.2 DC	7.5...30	200	85	300	4	NG500A
	M18 / L = 46	8 f	Brass	8.2 DC	7.5...30	200	190	400	3	NG501A
	M30 / L = 50	22 nf	Brass	8.2 DC	7.5...30	250	120	100	156	NI500A
	M30 / L = 50	15 f	Brass	8.2 DC	7.5...30	230	210	100	155	NI501A



Position sensors

Type	Dimensions [mm]	Sensing range [mm]	Material	U _{nom.} at 1 KΩ [V]	U _b [V]	Internal capacit. [nF]	Internal inductance [μH]	f [Hz]	Draw- ing no.	Order no.
M12 connector · Output function  · 2-wire · Connection to certified intrinsically safe circuits with the max. values U = 15 V / I = 50 mA / P = 120 mW · Wiring diagram no. 31 · Connector group 155										
	40 x 40 x 66	20 f	PPE	8.2 DC	7.5...30	250	450	200	116	NM500A
	40 x 40 x 66	35 nf	PPE	8.2 DC	7.5...30	220	710	100	116	NM501A

f = flush / nf = non flush



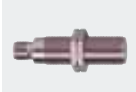









Sensors with ATEX approval 3D/3G

Type	Dimensions [mm]	Sensing range [mm]	Material	U _{nom.} at 1 KΩ [V]	U _b [V]	Internal capacit. [nF]	Internal inductance [μH]	f [Hz]	Draw- ing no.	Order no.
M12 connector · Output function normally open / closed · 4-wire · DC PNP · Wiring diagram no. 10 · Connector groups 154, 156										
	40 x 40 x 54	40 nf	PC	10...30 DC	–	–	–	60	241	IM511A
	40 x 40 x 54	20 f	PC	10...30 DC	–	–	–	100	241	IM512A
	40 x 40 x 54	30 nf	PC	10...30 DC	–	–	–	100	241	IM513A
M12 connector · Output function  · 3-wire · DC PNP · Wiring diagram no. 1 · Connector groups 154, 156										
	M12 / L = 70.2	6 nf	High-grade st. steel	10...36 DC	–	–	–	500	242	IF505A
	M18 / L = 70	12 nf	High-grade st. steel	10...36 DC	–	–	–	500	202	IG511A
	M30 / L = 70	25 nf	High-grade st. steel	10...36 DC	–	–	–	250	203	II503A
	M18 / L = 70	5 f	High-grade st. steel	10...36 DC	–	–	–	100	61	IG510A
	M30 / L = 70	10 f	High-grade st. steel	10...36 DC	–	–	–	50	243	II502A
	M12 / L = 60	3 f	High-grade st. steel	10...36 DC	–	–	–	100	244	IF503A

Type	Dimensions [mm]	Sensing range [mm]	Material	U _{nom.} at 1 KΩ [V]	U _b [V]	Internal capacit. [nF]	Internal inductance [μH]	f [Hz]	Draw- ing no.	Order no.
M12 connector · Output function  · 3-wire · DC PNP · Wiring diagram no. 2 · Connector groups 154, 156										
	M18 / L = 70	5 f	High-grade st. steel	10...36 DC	–	–	–	100	61	IG512A
	M12 / L = 60	3 f	High-grade st. steel	10...36 DC	–	–	–	100	244	IF504A

f = flush / nf = non flush

Sensors with ATEX approval 3D

Type	Dimensions [mm]	Sensing range [mm]	Material	U _{nom.} at 1 KΩ [V]	U _b [V]	Internal capacit. [nF]	Internal inductance [μH]	f [Hz]	Draw- ing no.	Order no.
Cable 2 m · Output function  · 2-wire · AC/DC · Wiring diagram no. 13										
	M18 / L = 80	8 nf	Brass	20...250 AC/DC	–	–	–	25 / 50	245	IG001A*
Cable 2 m · Output function  · 3-wire · DC PNP · Wiring diagram no. 4										
	M18 / L = 80	8 nf	Brass	10...30 DC	–	–	–	300	245	IG513A
Cable 2 m · Output function  · 2-wire · DC PNP/NPN · Wiring diagram no. 41										
	M18 / L = 80	8 nf	Brass	10...30 DC	–	–	–	300	245	IG515A
Cable 6 m · Output function  · 2-wire · AC/DC · Wiring diagram no. 13										
	M30 / L = 81	15 nf	Brass	20...250 AC/DC	–	–	–	25 / 50	246	II001A*
M12 connector · Output function  · 4-wire · DC PNP · Wiring diagram no. 10 · Connector groups 154, 156										
	M18 / L = 80	10 nf	High-grade st. steel	10...30 DC	–	–	–	300	247	IG514A
Terminals · Output function normally open / closed · 4-wire · DC · Wiring diagram no. 32										
	40 x 40 x 105	20 f	PC	10...30 DC	–	–	–	100	248	IM510A
Terminals · Output function  · 4-wire · DC · Wiring diagram no. 33										
	40 x 40 x 105	20 f	PC	10...30 DC	–	–	–	100	248	IM509A

Position sensors

Type	Dimensions [mm]	Sensing range [mm]	Material	U _{nom.} at 1 kΩ [V]	U _b [V]	Internal capacit. [nF]	Internal inductance [μH]	f [Hz]	Draw- ing no.	Order no.
Terminals · Output function  · 2-wire · AC/DC · Wiring diagram no. 45										
	105 x 80 x 42	60 nf	PPE	20...250 AC/DC	–	–	–	4	249	ID002A*
Terminals · Output function  · 2-wire · AC/DC · Wiring diagram no. 50										
	40 x 40 x 105	40 nf	PC	20...250 AC/DC	–	–	–	10	248	IM002A*
Terminals · Output function  · 2-wire · DC · Wiring diagram no. 51										
	40 x 40 x 105	20 f	PC	10...55 DC	–	–	–	100	248	IM508A
Terminals · Output function  · 3-wire · AC/DC · Wiring diagram no. 50										
	40 x 40 x 105	20 f	PC	20...250 AC/DC	–	–	–	10	248	IM001A*
Terminals · Output function  · 3-wire · DC PNP · Wiring diagram no. 44										
	105 x 80 x 42	60 nf	PPE	10...30 DC	–	–	–	100	249	ID502A
Terminals · Output function  · 4-wire · DC · Wiring diagram no. 52										
	40 x 40 x 105	20 f	PC	10...30 DC	–	–	–	100	248	IM506A
	40 x 40 x 105	40 nf	PC	10...30 DC	–	–	–	100	248	IM507A

f = flush / nf = non flush

* Note for AC and AC/DC units



Miniature fuse to IEC60127-2 sheet 1, ≤ 2 A (fast acting) Recommendation: check the unit for reliable function after a short circuit.

Sensors with ATEX approval 2D / 3G

Type	Dimensions [mm]	Sensing range [mm]	Material	U _{nom.} at 1 KΩ [V]	U _b [V]	Internal capacit. [nF]	Internal inductance [μH]	f [Hz]	Drawing no.	Order no.
------	--------------------	-----------------------	----------	-------------------------------------	-----------------------	---------------------------	-----------------------------	-----------	-------------	-----------

M12 connector · Output function  · 3-wire · DC PNP · Wiring diagram no. 34 · Connector groups 154, 156

	M30 / L = 70	10 f	High-grade st. steel	10...36 DC	-	-	-	50	243	II504A
---	--------------	------	----------------------	------------	---	---	---	----	-----	--------

Terminals · Output function  /  · 3-wire · DC PNP · Wiring diagram no. 53

	105 x 80 x 42	60 nf	modified PPE	10...30 DC	-	-	-	100	249	ID503A
---	---------------	-------	--------------	------------	---	---	---	-----	-----	--------

f = flush / nf = non flush

Slot sensors with ATEX approval 1D/1G

Type	Dimensions [mm]	Sensing range [mm]	Material	U _b [V]	Protection	f [Hz]	I _{load} [mA]	Drawing no.	Order no.
------	--------------------	-----------------------	----------	-----------------------	------------	-----------	---------------------------	-------------	-----------

Cable 0.065 m · Output function  · Connection to certified intrinsically safe circuits with the max. values U = 15 V / I = 50 mA / P = 120 mW · Wiring diagram no. 35

	special design	-	PBT	-	IP 67	3000	-	250	N7523A
---	----------------	---	-----	---	-------	------	---	-----	--------

Cable 0.5 m · Output function  · Connection to certified intrinsically safe circuits with the max. values U = 15 V / I = 50 mA / P = 120 mW · Wiring diagram no. 29

	Special design	-	PBT	-	IP 67	5000	-	251	N7520A
---	----------------	---	-----	---	-------	------	---	-----	--------

Cable with connector 0.065 m · Output function  · Connection to certified intrinsically safe circuits with the max. values U = 15 V / I = 50 mA / P = 120 mW · Wiring diagram no. 36

	Special design	-	PBT	-	IP 67	3000	-	252	N7521A
---	----------------	---	-----	---	-------	------	---	-----	--------







Switching amplifiers with ATEX approval

Type	Description	Order no.
------	-------------	-----------

	Switching amplifier for Namur sensors according to 94/9/EG (ATEX) · ATEX approval · Group II, category (1) G D · 1-channel · Relay output · Programmable output function · Short-circuit and wire monitoring	N0031A
	Switching amplifier for Namur sensors according to 94/9/EG (ATEX) · ATEX approval · Group II, category (1) G D · 2-channel · Relay outputs · Programmable output function · Short-circuit and wire monitoring	N0032A
	Switching amplifier for Namur sensors according to 94/9/EG (ATEX) · ATEX approval · Group II, category (1) G D · 2-channel · Relay outputs · Programmable output function · Short-circuit and wire monitoring	N0033A

Type	Description	Order no.
	Switching amplifier for Namur sensors according to 94/9/EG (ATEX) · ATEX approval · Group II, category (1) G D · 1-channel · Relay output · Programmable output function · Short-circuit and wire monitoring	N0530A
	Switching amplifier for Namur sensors according to 94/9/EG (ATEX) · ATEX approval · Group II, category (1) G D · 1-channel · Transistor outputs · Programmable output function · Short-circuit and wire monitoring	N0531A
	Switching amplifier for Namur sensors according to 94/9/EG (ATEX) · ATEX approval · Group II, category (1) G D · 2-channel · Optocoupler output · Programmable output function · Short-circuit and wire monitoring	N0532A
	Switching amplifier for Namur sensors according to 94/9/EG (ATEX) · ATEX approval · Group II, category (1) G D · 2-channel · Relay outputs · Programmable output function · Short-circuit and wire monitoring	N0533A
	Switching amplifier for Namur sensors according to 94/9/EG (ATEX) · ATEX approval · Group II, category (1) G D · 2-channel · Transistor outputs · Programmable output function · Short-circuit and wire monitoring	N0534A







Accessories for sensors with smooth sleeve

Type	Description	Order no.
	Mounting clip · Ø 12 mm · for smooth body switches - Ø 12 mm · Form V · Housing materials: stainless steel	E11530
	Mounting clip · Ø 18 mm · for smooth body switches - Ø 18 mm · Form V · Housing materials: stainless steel	E11531
	Mounting clamp · Ø 4 mm · Housing materials: TPE	E10204
	Mounting clamp · Ø 6.5 mm · Housing materials: PPE	E10014
	Mounting clamp · Ø 20 mm · Housing materials: PA	E10192
	Mounting clamp · Ø 34 mm · Housing materials: PA	E10193
	Mounting clamp · Ø 20 mm · Housing materials: Mounting clamp: PBT / socket screw: steel galvanised	E10016
	Mounting clamp · Ø 34 mm · Housing materials: PBT	E10017
	Limit plungers · for type Ø 6.5 mm · with Sn = 1 mm f · Housing materials: Limit plungers: free cutting steel / plunger: C45K hardened on front / nut: Brass nickel-plated	E10155

Accessories for threaded M8 housings

Type	Description	Order no.
	Angle bracket · for type M8 · Housing materials: stainless steel	E10734
	Mounting clamp · Ø 8 mm · Housing materials: aluminium black anodised	E10221
	Mounting clamp · Ø 8 mm · with end stop · for type M8 · Housing materials: PC	E11521
	Mounting sleeve · M12 x 1 - Ø 8 mm · 32 mm · with end stop · for type M8 · Housing materials: Brass special coating	E10848
	Mounting sleeve · M12 x 1 - Ø 8 mm · 42 mm · with end stop · for type M8 · Housing materials: Brass special coating	E10849
	Limit plungers · for types M8 x 1 · with Sn = 1 mm f, 2 mm f and 3 mm f · Housing materials: Limit plungers: free cutting steel / plunger: C45K hardened on front / nut: Brass nickel-plated	E10154

Accessories for threaded M12 housings









Type	Description	Order no.
	Angle bracket · for type M12 · Housing materials: stainless steel	E10735
	Mounting clip · O-shaped · for type M12 · Housing materials: stainless steel	E11533
	Mounting clamp · Ø 12 mm · Housing materials: PBT	E10015
	Mounting clamp · Ø 12 mm · with end stop · for type M12 · Housing materials: PC	E11047
	Mounting clamp · Ø 12 mm · with end stop · For sensors with 45° chamfer · for type M12 · Housing materials: PC	E11994
	Mounting sleeve · M16 x 1 - Ø 12 mm · 45 mm · with end stop · for type M12 · Housing materials: Brass nickel-plated	E10741
	Mounting sleeve · M16 x 1 - Ø 12 mm · 34 mm · with end stop · for type M12 · Housing materials: Brass nickel-plated	E10806

You can find wiring diagrams and scale drawings from page 125

Position sensors









Type	Description	Order no.
	Mounting sleeve · M16 x 1 - Ø 12 mm · with end stop · for type M12 · Housing materials: Brass nickel-plated	E11114
	Lock nuts metal · M12 x 1 · Housing materials: Brass nickel-plated	E10024
	Lock nuts metal · M12 x 1 · Housing materials: stainless steel 316Ti / 1.4571	E10025

Accessories for threaded M18 housings



Type	Description	Order no.
	Angle bracket · for type M18 · Housing materials: stainless steel	E10736
	Mounting clip · O-shaped · for type M18 · Housing materials: stainless steel	E11534
	Mounting clamp · Ø 20 mm - Ø 18 mm · with reducing bush · for type M18 · Housing materials: PBT	E10076
	Mounting clamp · Ø 18 mm · with end stop · for type M18 · Housing materials: PC	E11048
	Mounting clamp · Ø 18 mm · with end stop · For sensors with 45° chamfer · for type M18 · Housing materials: PC	E11995
	Mounting sleeve · M24 x 1.5 - Ø 18 mm · 58 mm · with end stop · for type M18 · Housing materials: Brass nickel-plated	E10742
	Mounting sleeve · M24 x 1.5 - Ø 18 mm · 36 mm · with end stop · for type M18 · Housing materials: Brass nickel-plated	E10807
	Mounting sleeve · M22 x 1 - Ø 18 mm · with end stop · for type M18 · Housing materials: Brass white bronze coated	E11115
	Plastic nut for flow plate · M18 x 1 · Housing materials: POM	E19503
	Lock nuts metal · M18 x 1 · Housing materials: Brass nickel-plated	E10027

Type	Description	Order no.
	Lock nuts metal · M18 x 1 · Housing materials: stainless steel 316Ti / 1.4571	E10028



Accessories for threaded M30 housings





Type	Description	Order no.
	Angle bracket · for type M30 · Housing materials: stainless steel	E10737
	Mounting clamp · Ø 34 mm - Ø 30 mm · with reducing bush · for type M30 · Housing materials: PBT	E10077
	Mounting clamp · Ø 30 mm · with end stop · for type M30 · Housing materials: PC	E11049
	Mounting clamp · Ø 30 mm · with end stop · For sensors with 45° chamfer · for type M30 · Housing materials: PC	E11996
	Mounting sleeve · M36 x 1.5 - Ø 30 mm · 58 mm · with end stop · for type M30 · Housing materials: Brass nickel-plated	E10743
	Mounting sleeve · M36 x 1.5 - Ø 30 mm · 36 mm · with end stop · for type M30 · Housing materials: Brass nickel-plated	E10808
	Lock nuts metal · M30 x 1.5 · Housing materials: Brass nickel-plated	E10030
	Lock nuts metal · M30 x 1.5 · Housing materials: stainless steel 316Ti / 1.4571	E10031

Accessories for rectangular housings

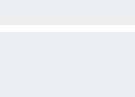
Type	Description	Order no.
	Mounting bracket · with integrated snap-on rail · for type IDC · Housing materials: stainless steel	E10730
	Protective bracket · for cable units · for type IW, KW · Housing materials: stainless steel 316Ti / 1.4571	E20813

System components

Type	Description	Order no.
	Mounting set · Ø 18.5 mm · Clamp mounting · Free-standing M10 · for type OG, IG, KG · Housing materials: clamp: diecast zinc / fixture: steel	E20718
	Mounting set · Ø 18.5 mm · Clamp mounting · Free-standing M10 · for type OG, IG, KG · Housing materials: clamp: diecast zinc / fixture: steel	E20719
	Angle bracket · Clamp mounting · for type IW, KQ5 · Housing materials: stainless steel 316Ti / 1.4571	E20811
	Protective bracket · for cable units · for type IW, KW · Housing materials: stainless steel 316Ti / 1.4571	E20813
	Protective bracket · for devices with M8 connection · for type IW · Housing materials: stainless steel 316Ti / 1.4571	E20814
	Mounting set · Ø 12.2 mm · Clamp mounting · free-standing M8 · for type OF, IF · Housing materials: fixture: stainless steel 316Ti / 1.4571 / clamp: diecast zinc	E20856
	Mounting set · Ø 12.2 mm · Clamp mounting · free-standing M8 · for type OF, IF · Housing materials: fixture: stainless steel 316Ti / 1.4571 / clamp: stainless steel	E20857
	Mounting set · Ø 12.2 mm · Clamp mounting · free-standing M8 · for type OF, IF · Housing materials: fixture: stainless steel 316Ti / 1.4571 / clamp: diecast zinc	E20860
	Mounting set · Ø 12.2 mm · Clamp mounting · free-standing M8 · for type OF, IF · Housing materials: fixture: stainless steel 316Ti / 1.4571 / clamp: stainless steel	E20861
	Mounting set · Ø 12.2 mm · Clamp mounting · aluminium profile · for type OF, IF · Housing materials: fixture: stainless steel 316Ti / 1.4571 / clamp: diecast zinc / Cube: diecast zinc	E20864
	Mounting set · Ø 12.2 mm · Clamp mounting · aluminium profile · for type OF, IF · Housing materials: fixture: stainless steel 316Ti / 1.4571 / clamp: diecast zinc / Cube: diecast zinc	E20865
	Mounting set · Ø 18.5 mm · Clamp mounting · aluminium profile · for type OG, IG, KG · Housing materials: fixture: stainless steel 316Ti / 1.4571 / clamp: diecast zinc / Cube: diecast zinc	E20866
	Mounting set · Ø 18.5 mm · Clamp mounting · aluminium profile · for type OG, IG, KG · Housing materials: fixture: stainless steel 316Ti / 1.4571 / clamp: diecast zinc / Cube: diecast zinc	E20867
	Mounting set · Ø 18.5 mm · Clamp mounting · Free-standing M10 · for type OG, IG, KG · Housing materials: fixture: stainless steel 316Ti / 1.4571 / clamp: stainless steel	E20869

Type	Description	Order no.
	Mounting set · Ø 18.5 mm · Clamp mounting · Free-standing M10 · for type OG, IG, KG · Housing materials: fixture: stainless steel 316Ti / 1.4571 / clamp: stainless steel	E20870
	Mounting set · Ø 30.2 mm · Clamp mounting · free-standing M12 · for type OI, II, KI · Housing materials: fixture: stainless steel 316Ti / 1.4571 / clamp: diecast zinc	E20873
	Mounting set · Ø 30.2 mm · Clamp mounting · free-standing M12 · for type OI, II, KI · Housing materials: fixture: stainless steel 316Ti / 1.4571 / clamp: stainless steel	E20874
	Mounting set · Ø 30.2 mm · Clamp mounting · aluminium profile · for type II, KI, OID, OI · Housing materials: fixture: stainless steel 316Ti / 1.4571 / clamp: diecast zinc / Cube: diecast zinc	E20875

Wiring diagrams

Core colours

- BN brown
- BU blue
- BK black
- WH white

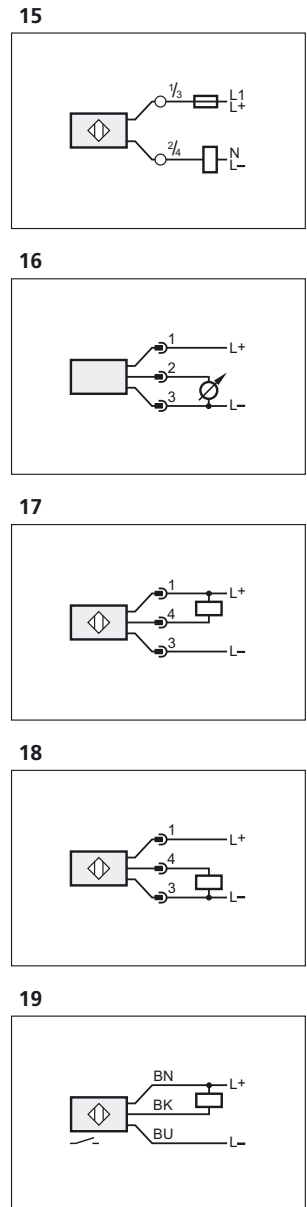
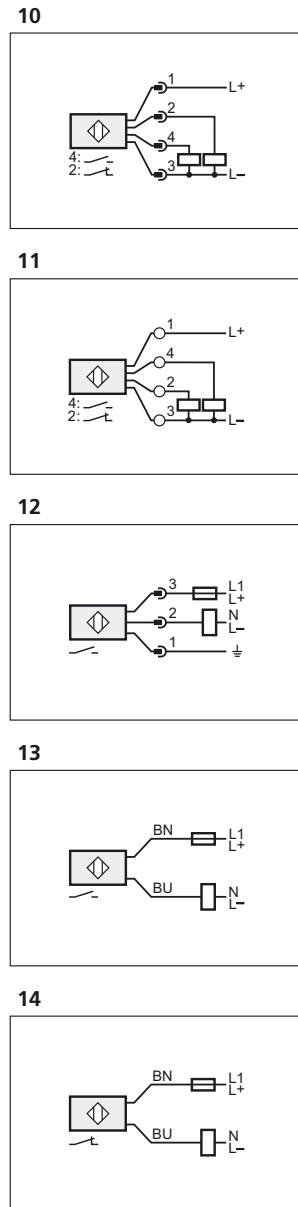
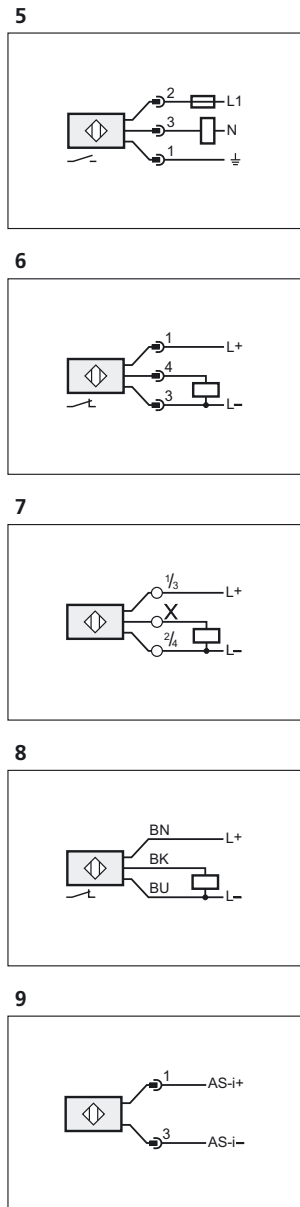
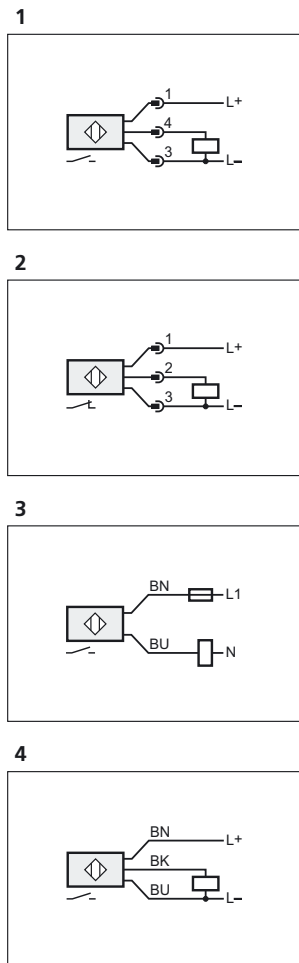

Wiring diagrams

20

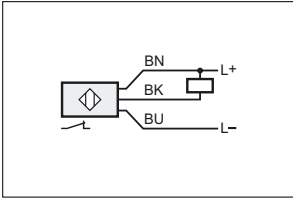

25

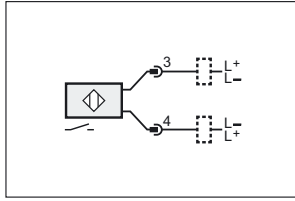

30

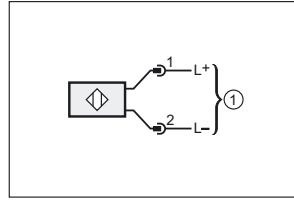

34

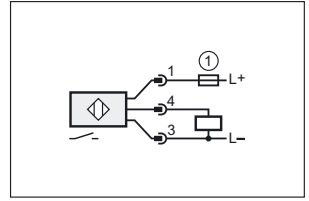

21

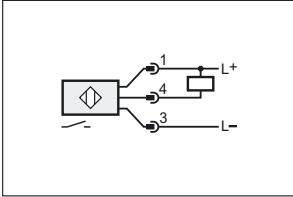

26

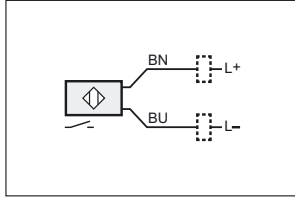

1: connection to NAMUR-amplifier

1: fuse

31

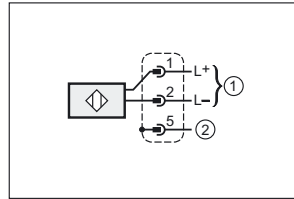

35

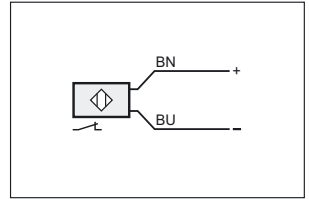

22

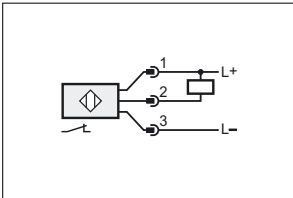

27

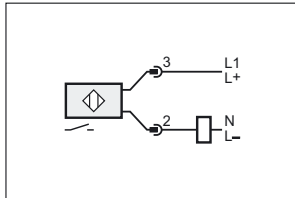

1: connection to NAMUR-amplifier, 2: Potential equalisation plug housing

36

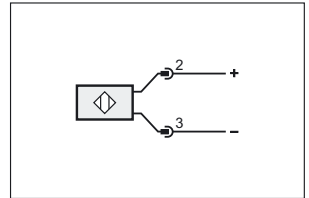

23

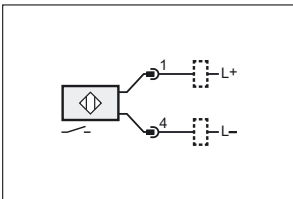

28

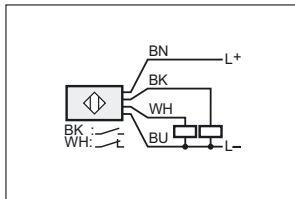

32

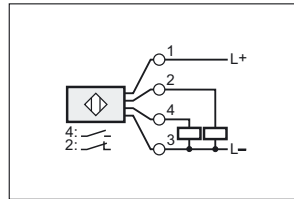

24

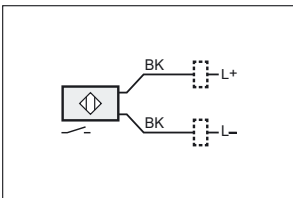

29

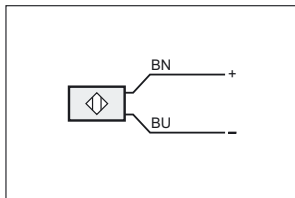

33

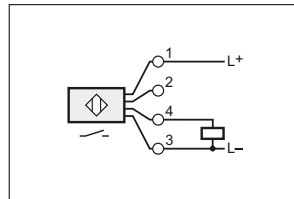

37

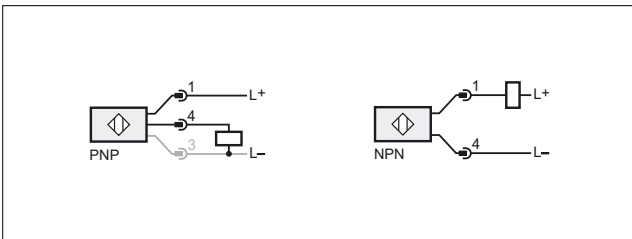

39

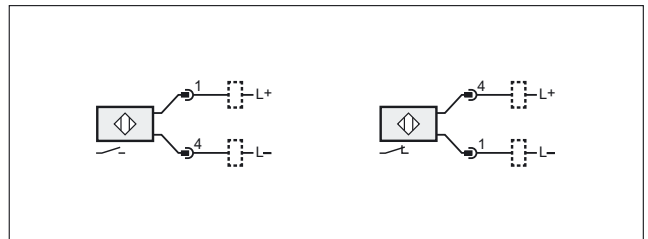

38

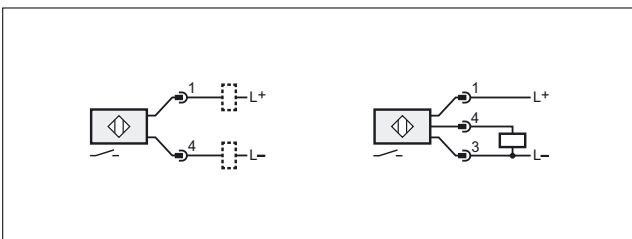

40

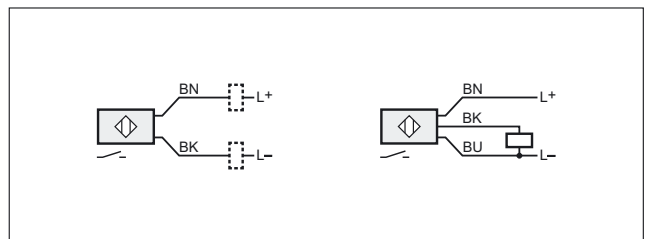

Wiring diagrams

41

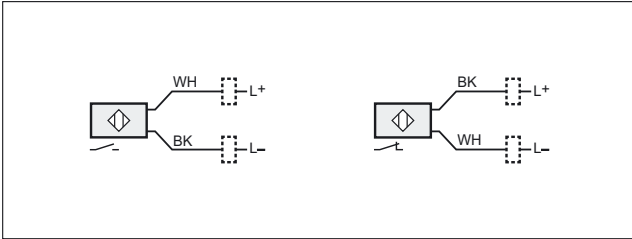

47

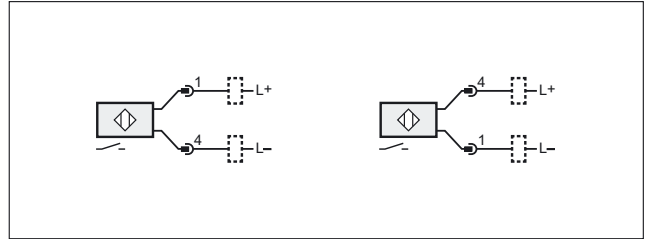

42

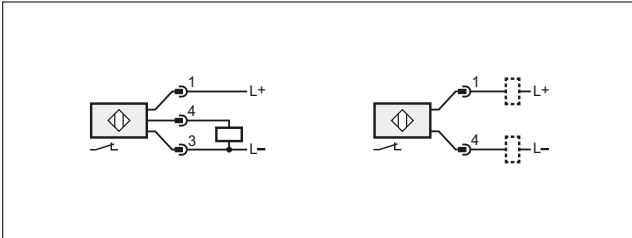

48

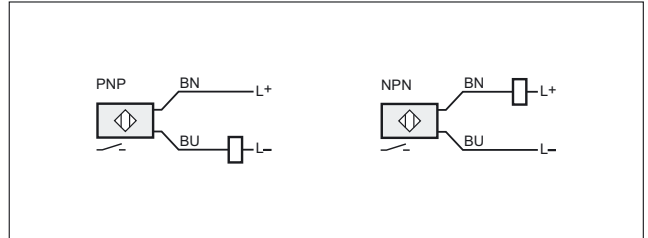

43

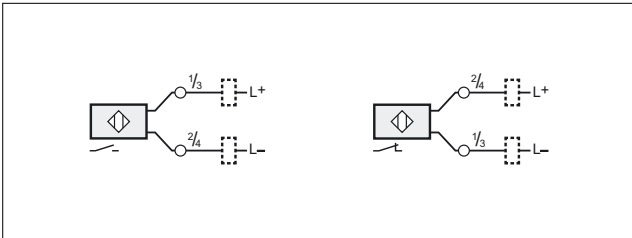

49

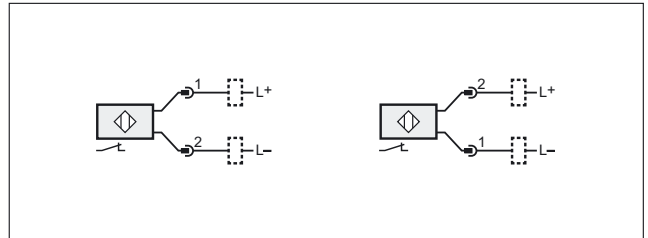

44

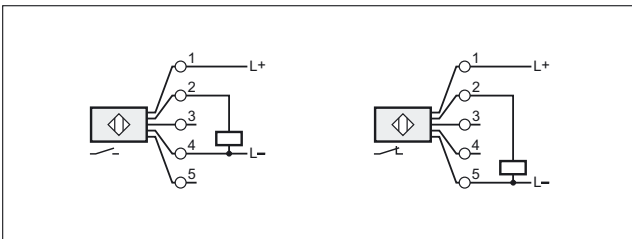

50

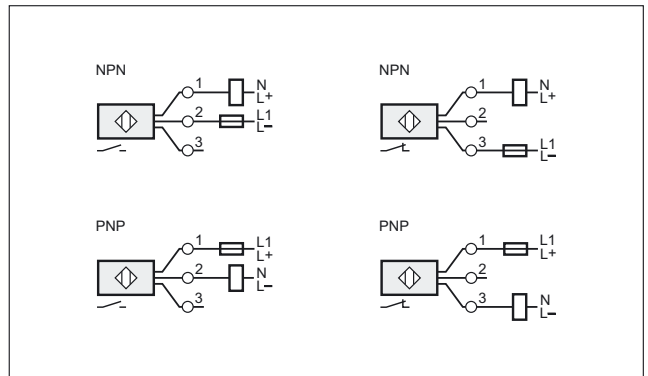

45

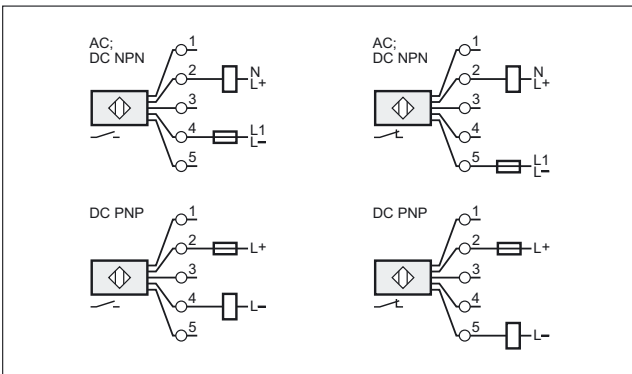

51

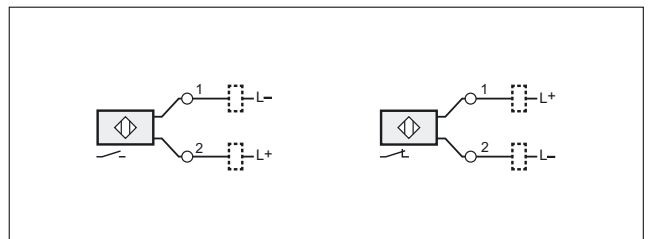

46

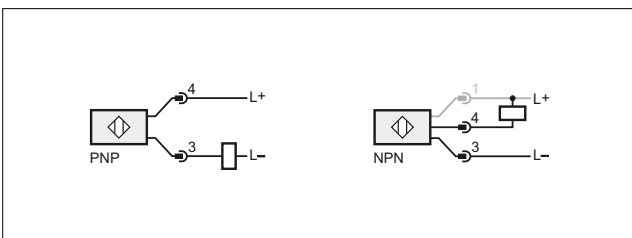

52

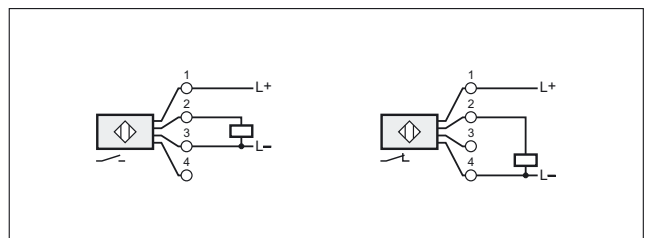

Wiring diagrams

53

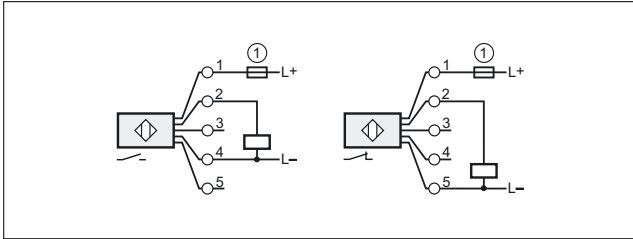

1: fuse

Scale drawings / drawing no. – CAD download: www.ifm.com

1

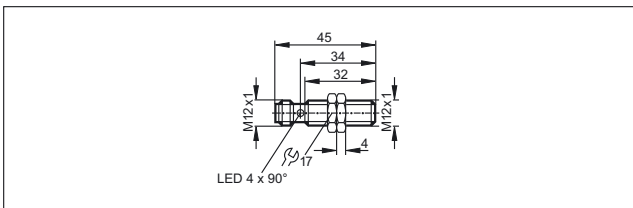

6

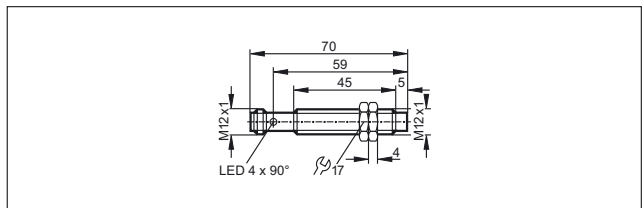

2

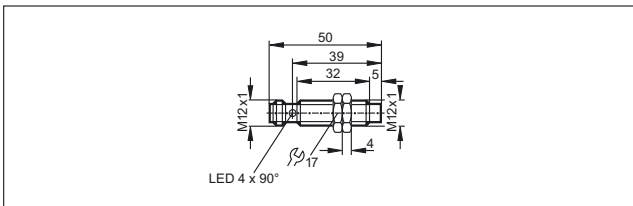

7

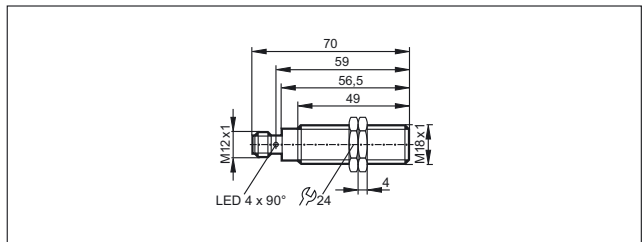

3

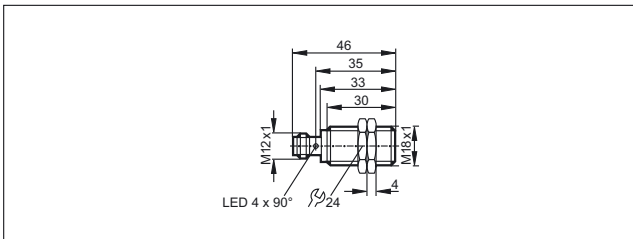

8

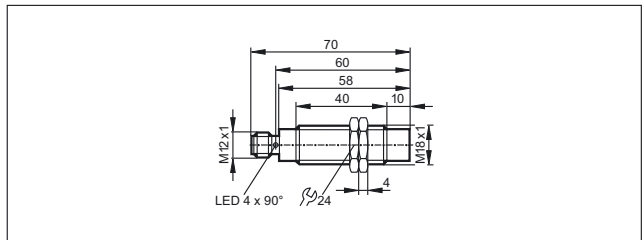

4

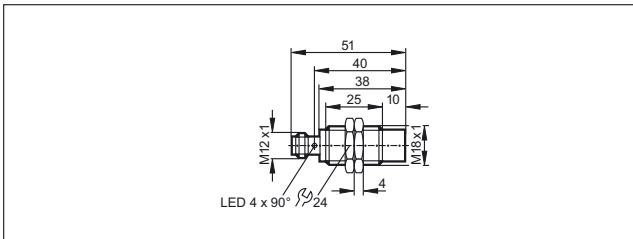

9

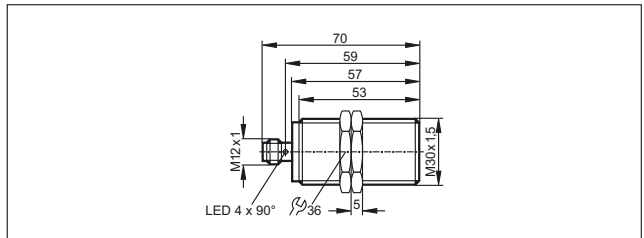

5

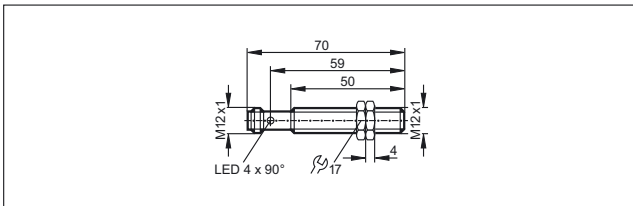

10

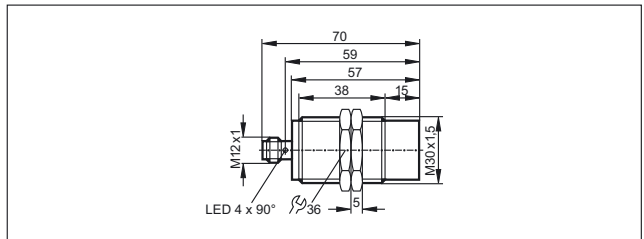

Scale drawings / drawing no. – CAD download: www.ifm.com

11

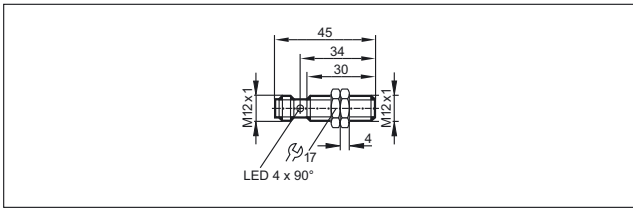

12

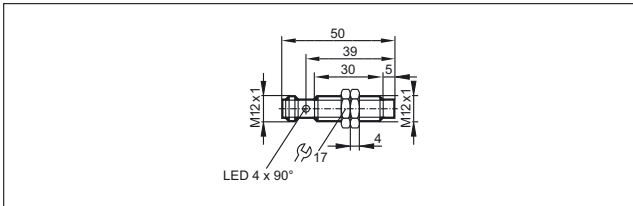

13

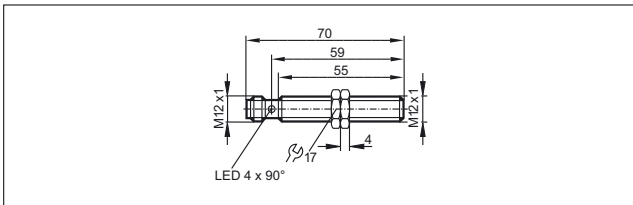

14

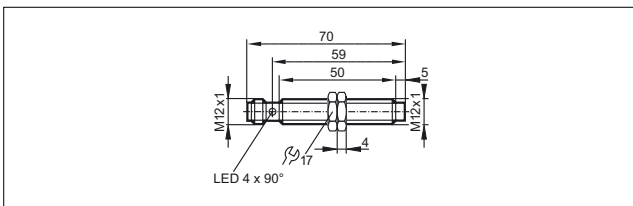

15

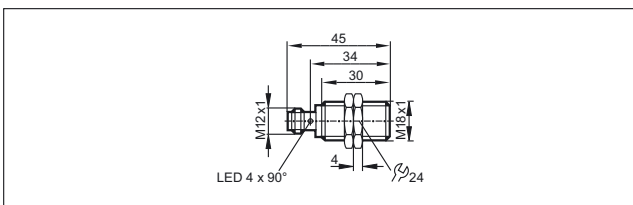

16

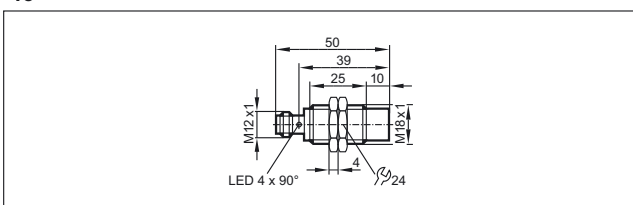

17

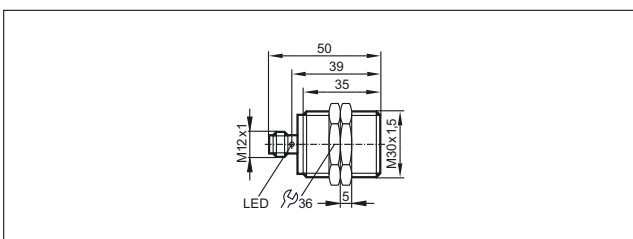

18

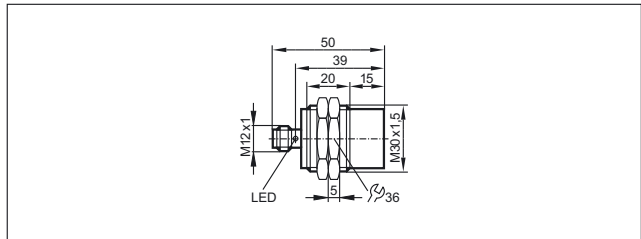

19

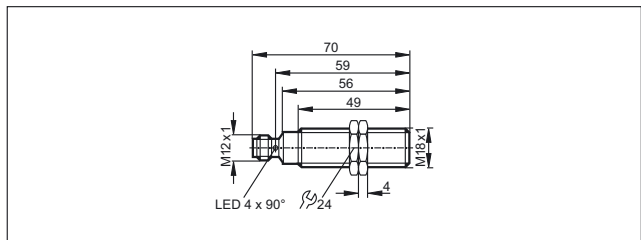

20

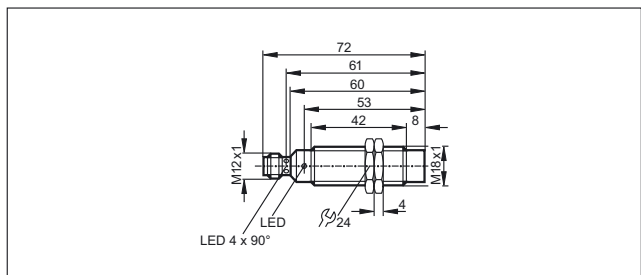

21

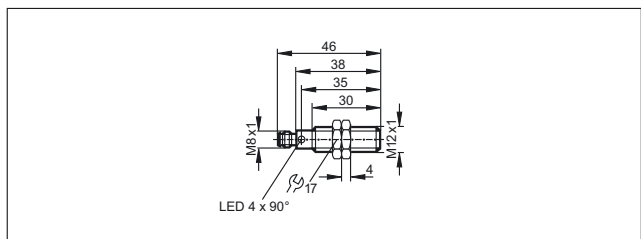

22

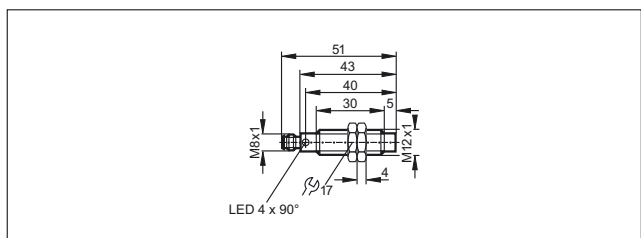

23

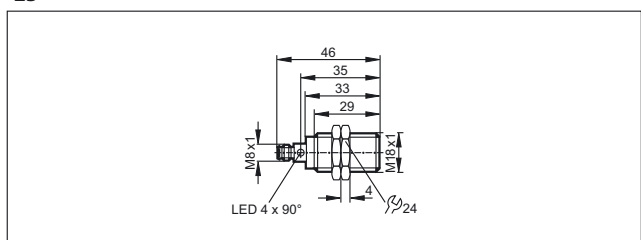

Scale drawings / drawing no. – CAD download: www.ifm.com

24

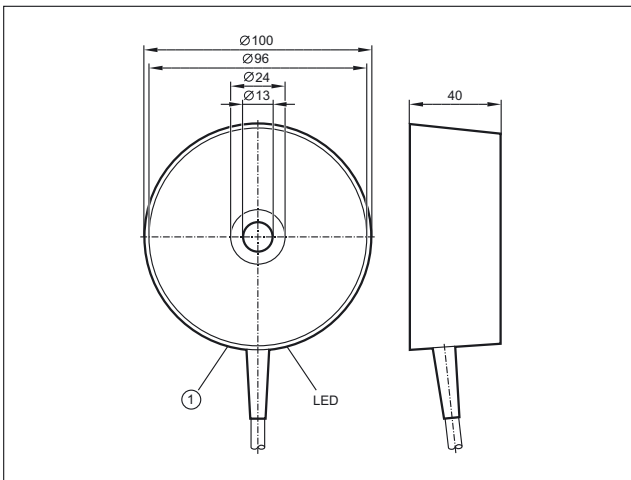

1: potentiometer

25

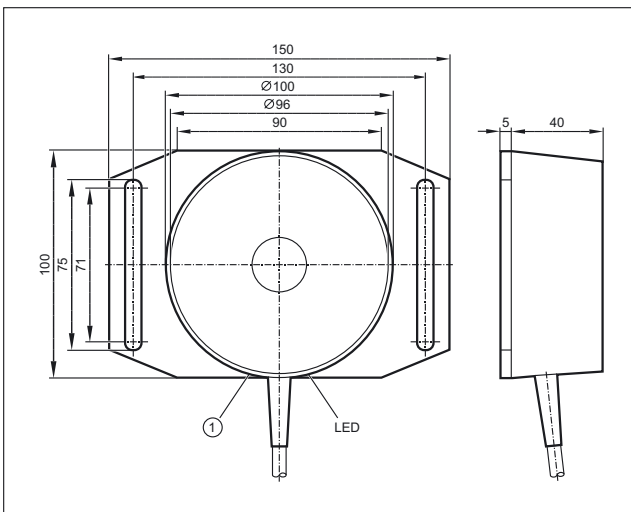

1: potentiometer

26

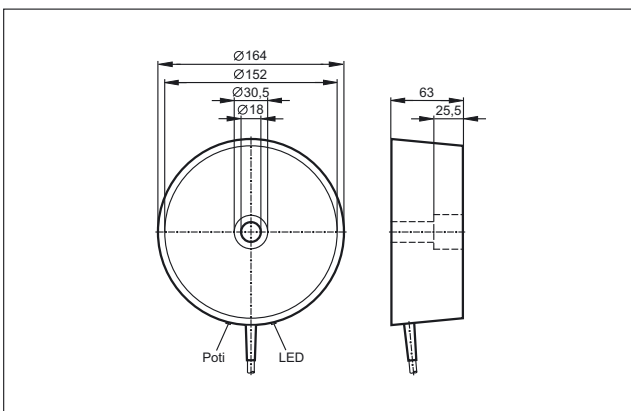

27

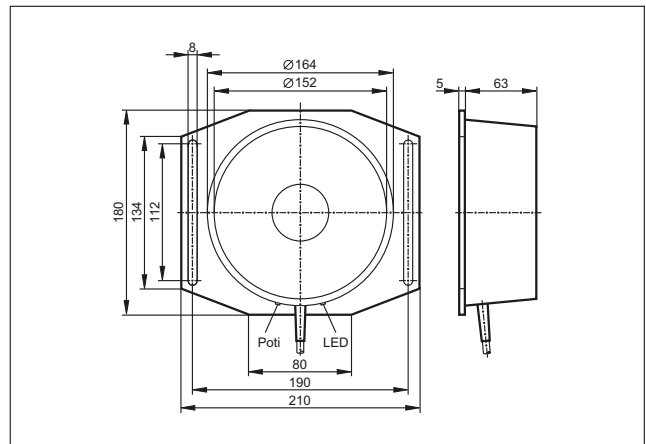

28

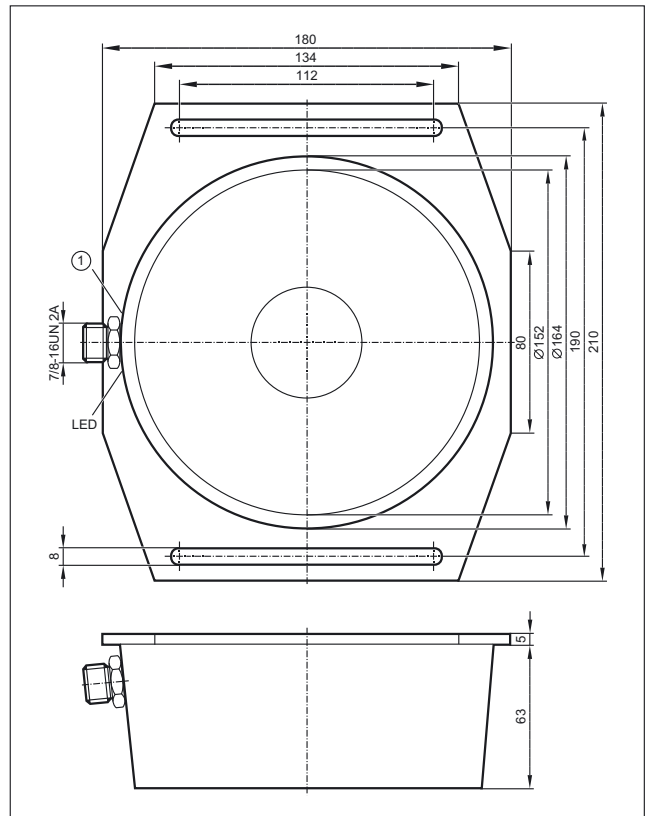

1: potentiometer

29

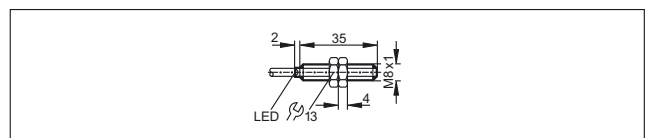

30

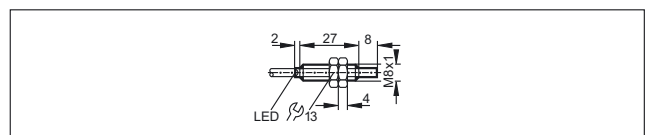

Scale drawings / drawing no. – CAD download: www.ifm.com

31

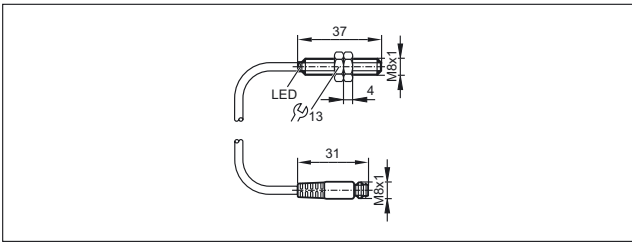

32

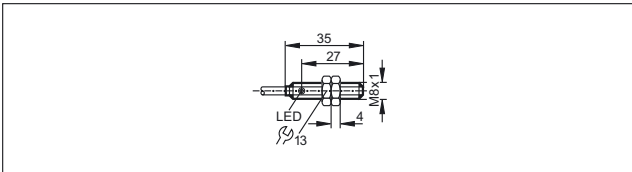

33

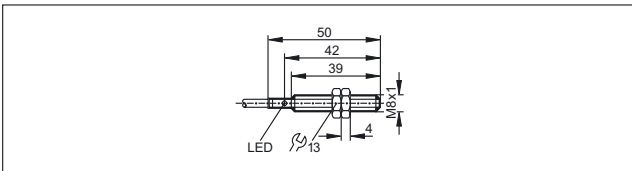

34

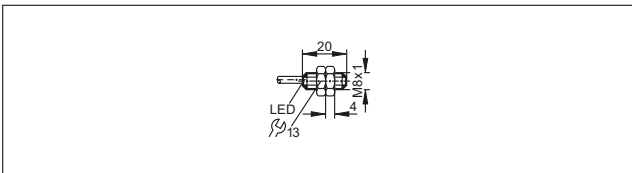

35

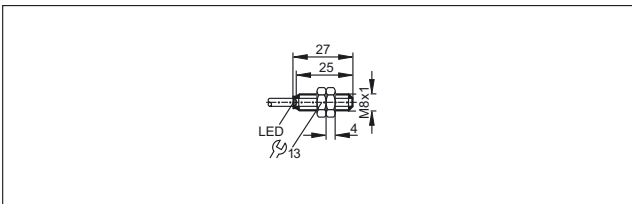

36

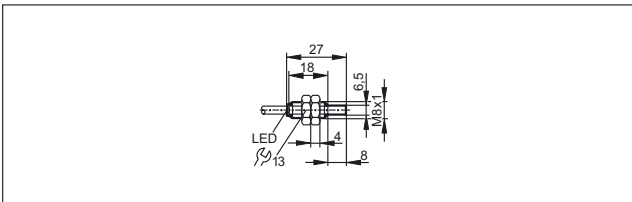

37

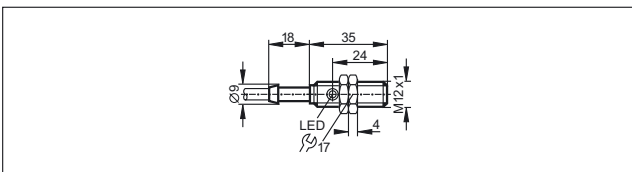

38

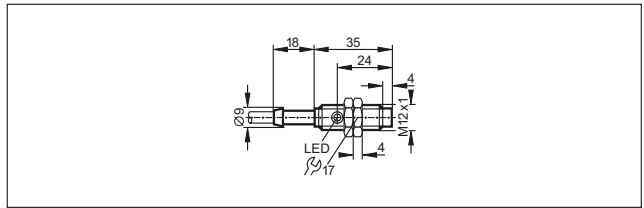

39

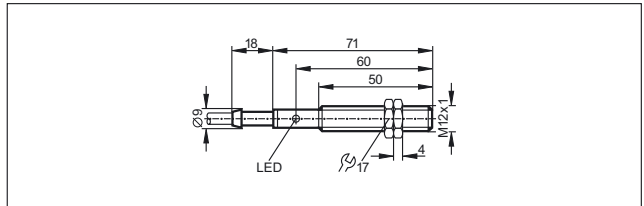

40

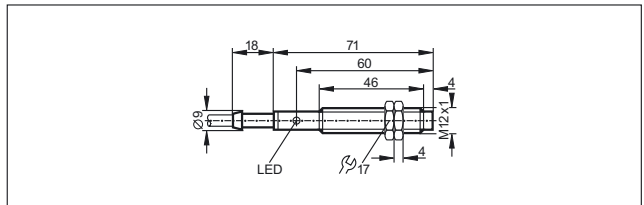

41

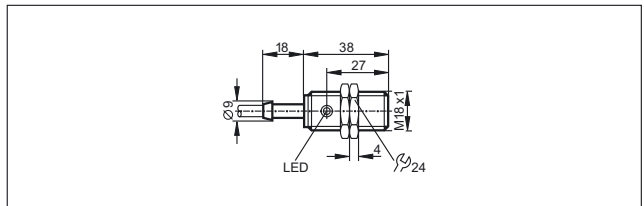

42

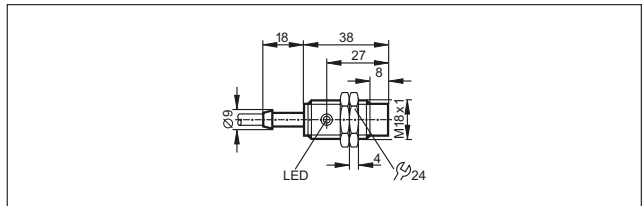

43

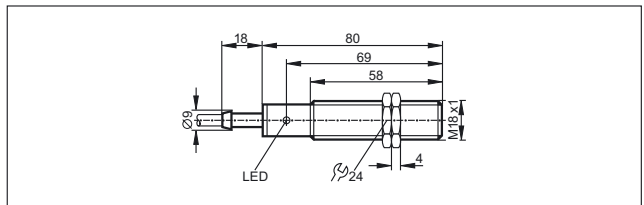

44

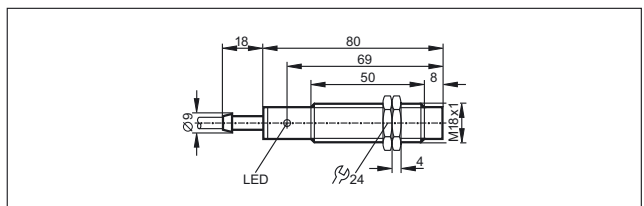

Scale drawings / drawing no. – CAD download: www.ifm.com

45

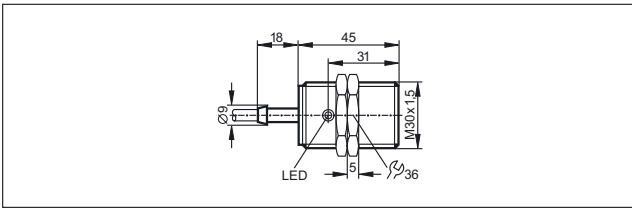

46

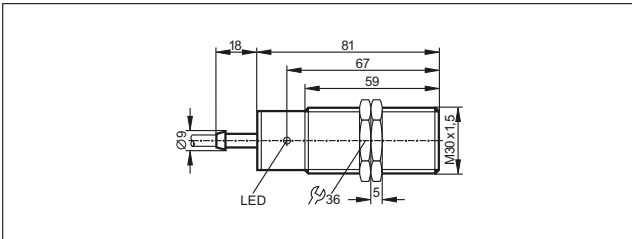

47

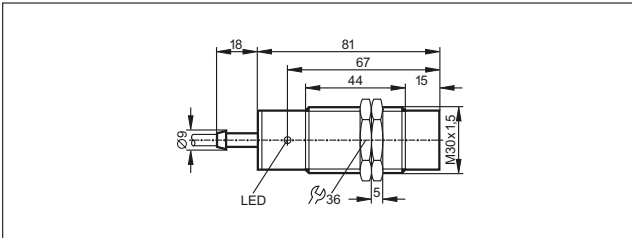

48

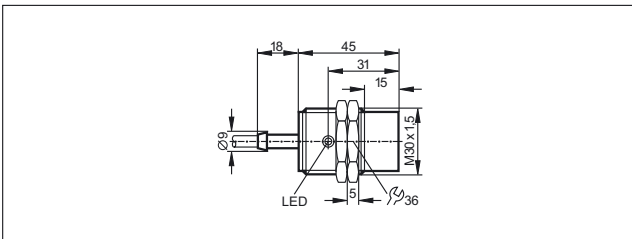

49

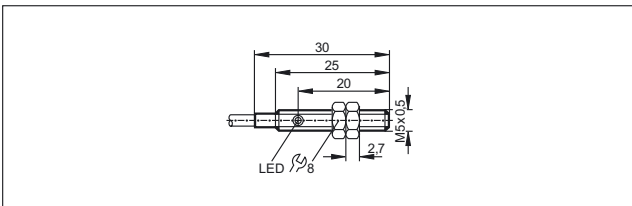

50

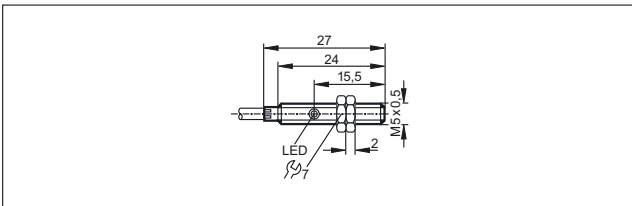

51

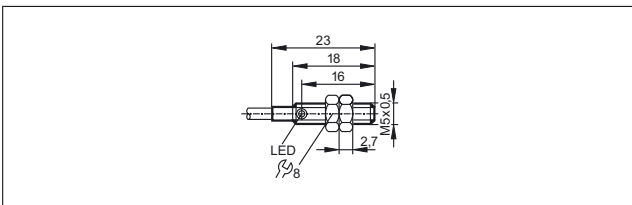

52

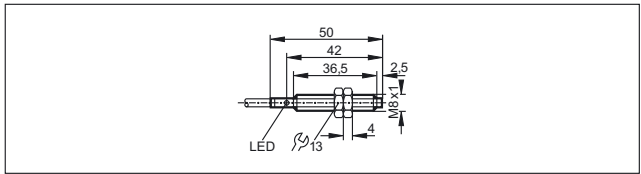

53

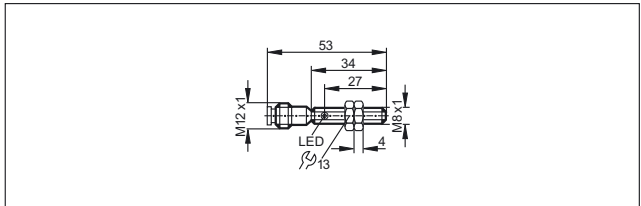

54

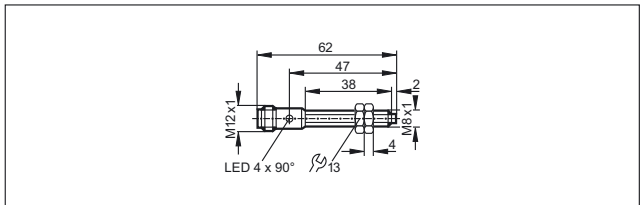

55

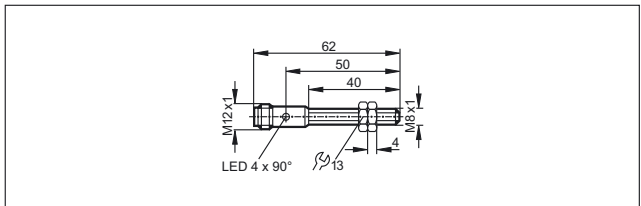

56

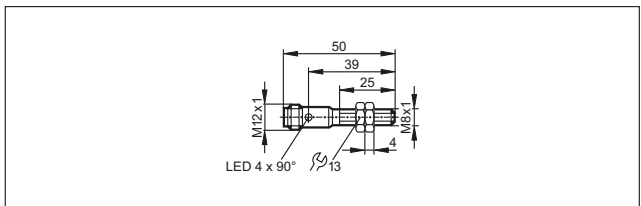

57

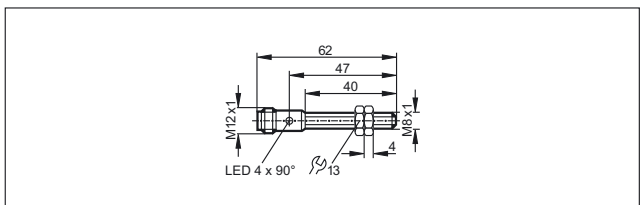

58

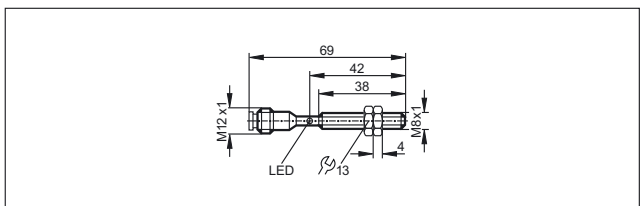

Scale drawings / drawing no. – CAD download: www.ifm.com

59

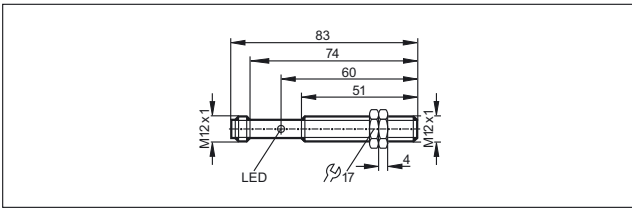

66

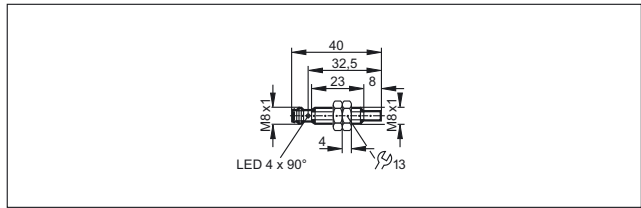

60

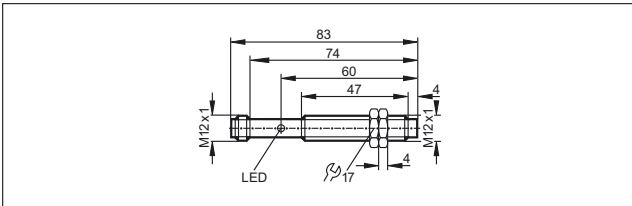

67

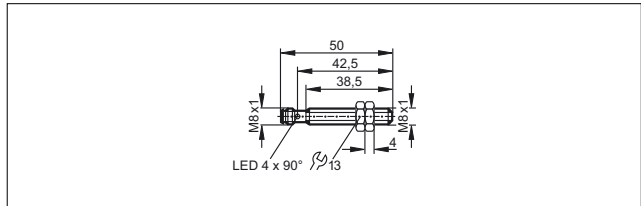

61

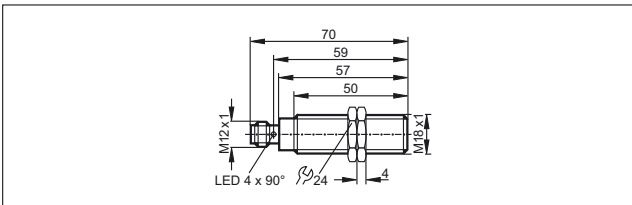

68

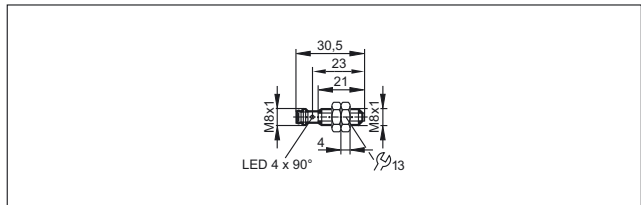

62

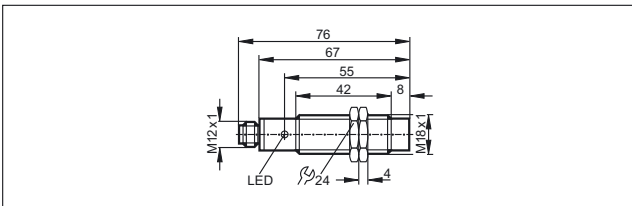

69

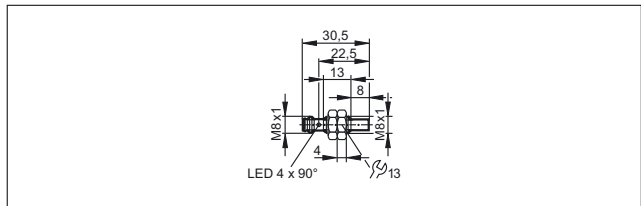

63

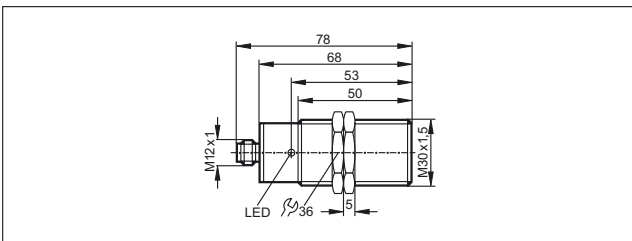

70

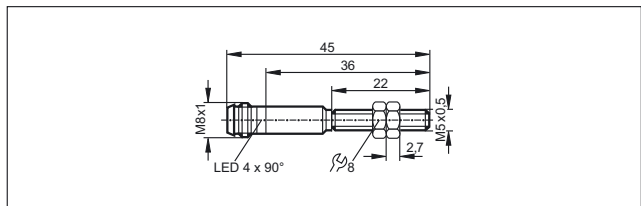

64

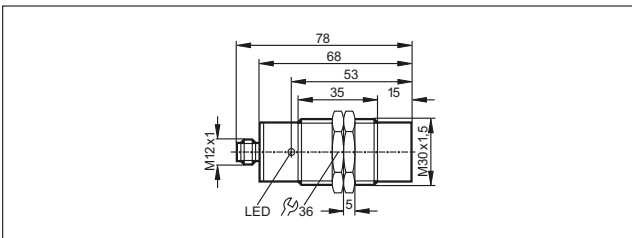

71

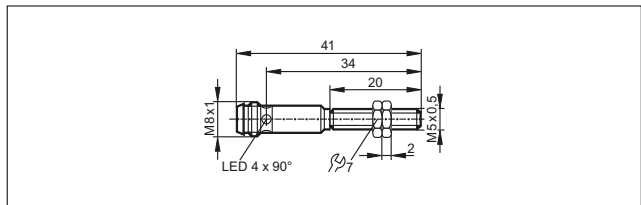

65

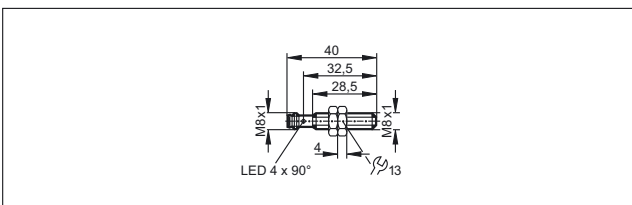

72

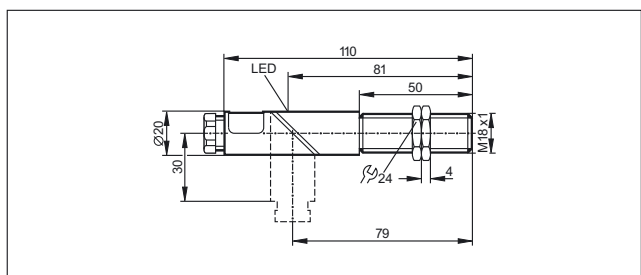

Scale drawings / drawing no. – CAD download: www.ifm.com

73

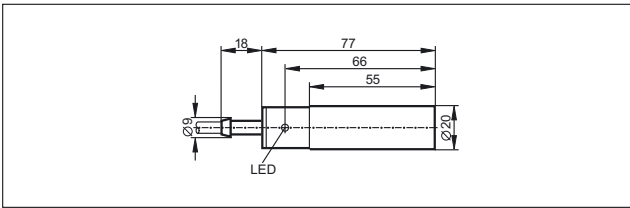

74

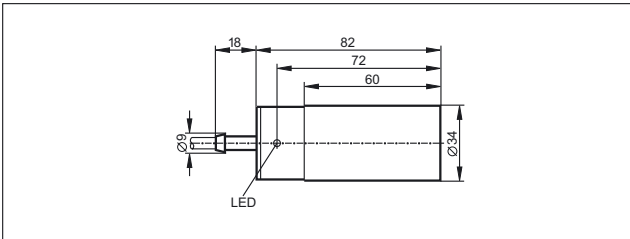

75

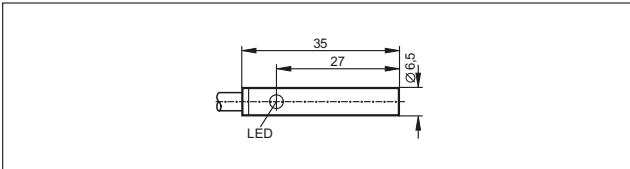

76

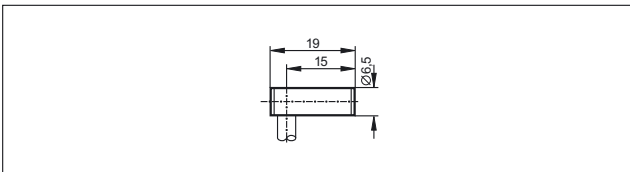

77

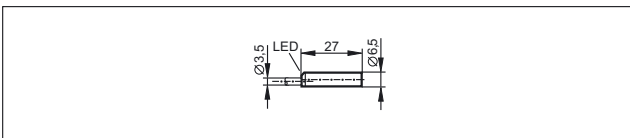

78

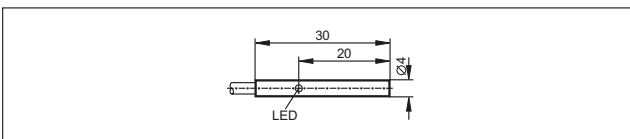

79

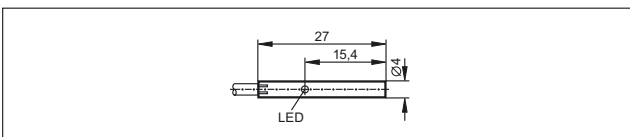

80

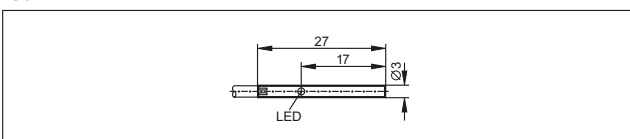

81

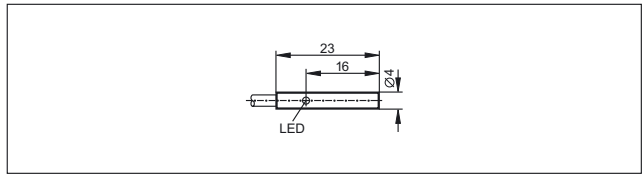

82

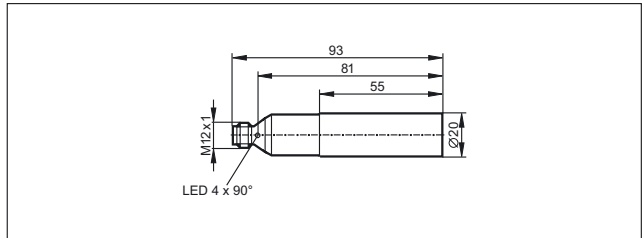

83

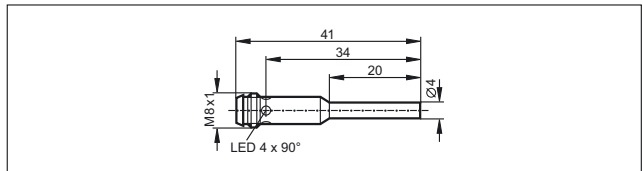

84

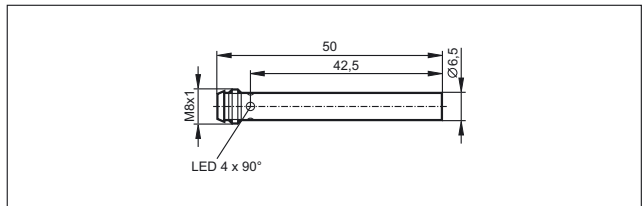

85

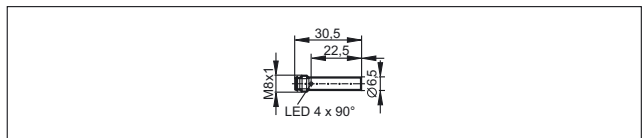

86

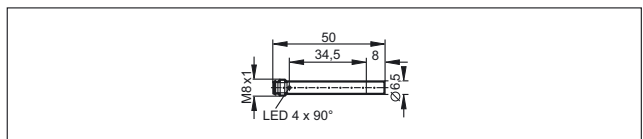

87

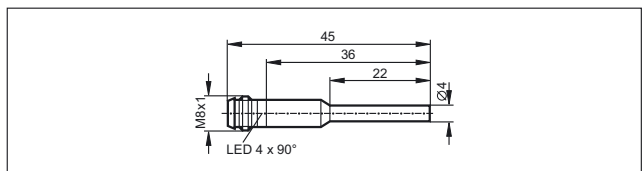

88

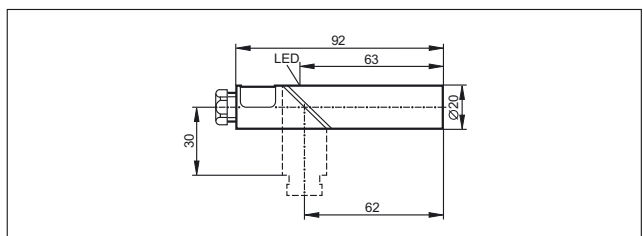

Scale drawings / drawing no. – CAD download: www.ifm.com

89

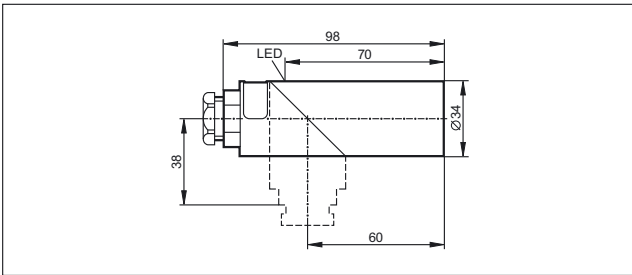

90

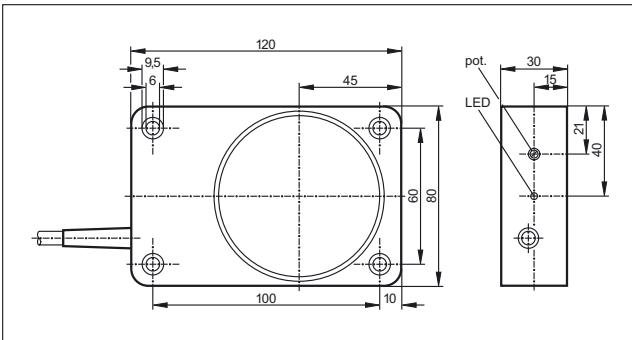

91

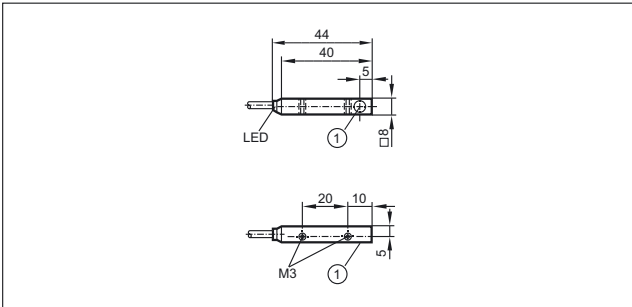

1: sensing face

92

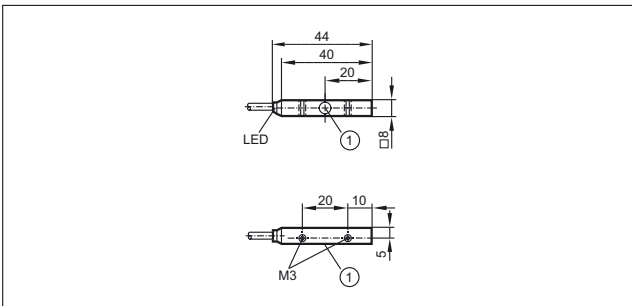

1: sensing face

93

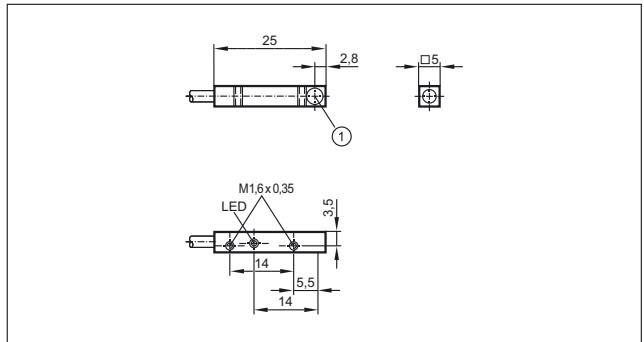

1: sensing face

94

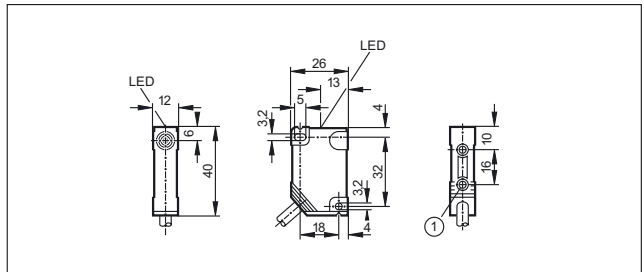

1: threaded insert M3, depth 5.8 mm, max. tightening torque 1.2 Nm (screw fixing class 8.8) when brass insert in contact with counterpart.

95

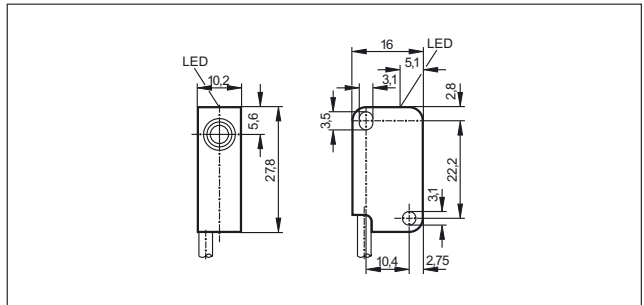

96

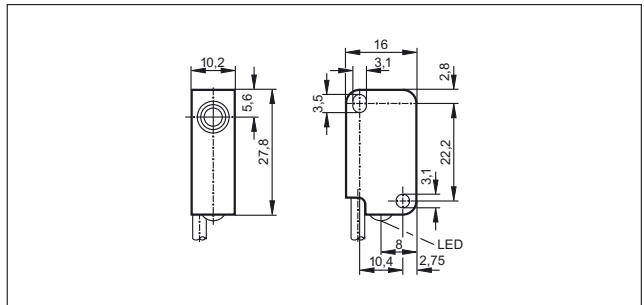

Scale drawings / drawing no. – CAD download: www.ifm.com

97

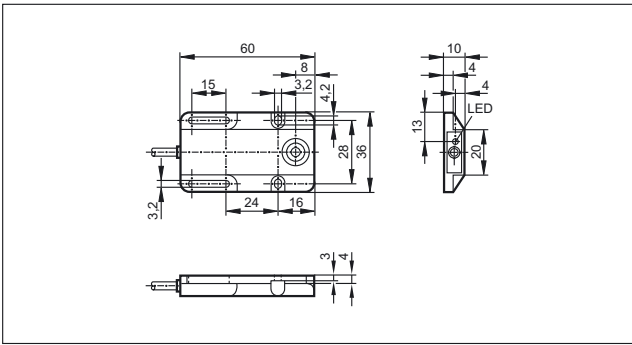

98

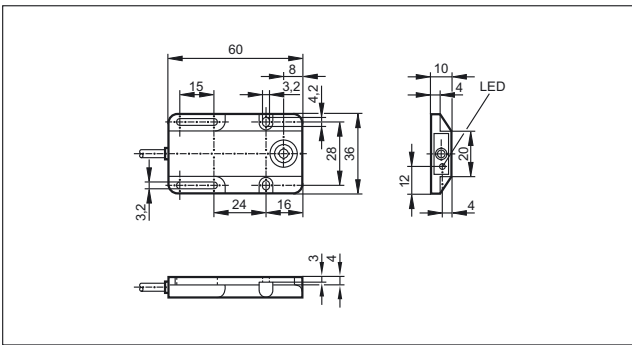

99

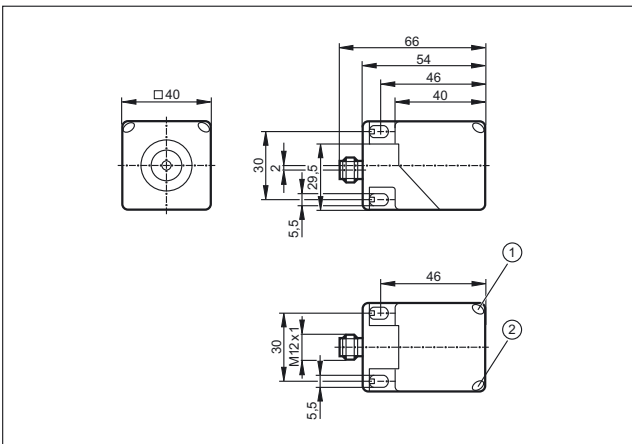

1: LED yellow, 2: LED green

100

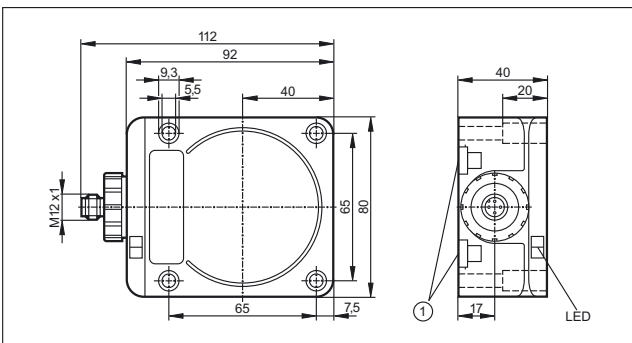

1: Mounting on DIN rail

101

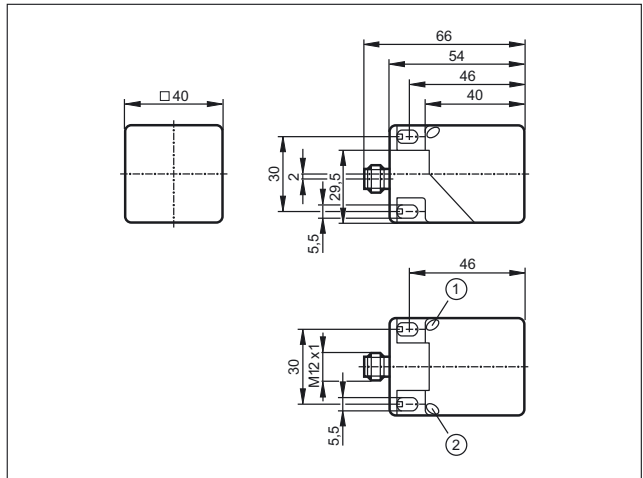

1: LED yellow, 2: LED green

102

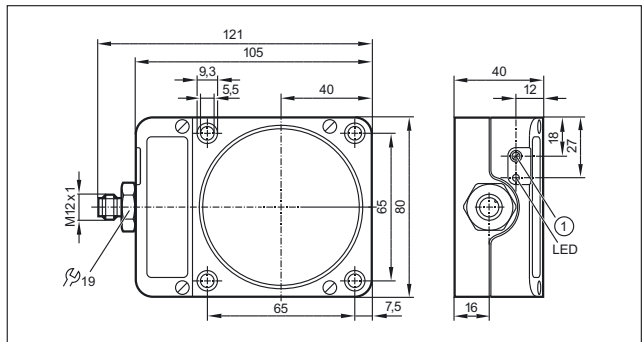

103

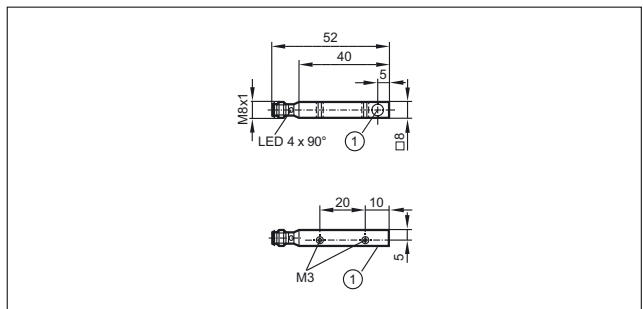

1: sensing face

104

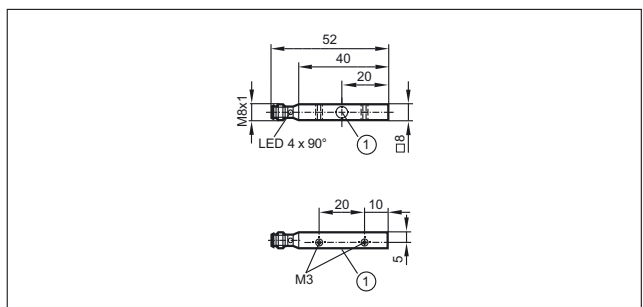

1: sensing face

Scale drawings / drawing no. – CAD download: www.ifm.com

105

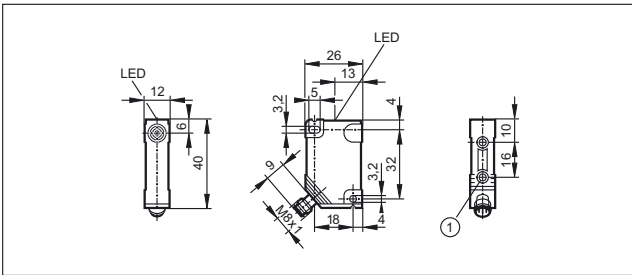

1: threaded insert M3, depth 5.8 mm, max. tightening torque 1.2 Nm (screw fixing class 8.8) when brass insert in contact with counterpart.

106

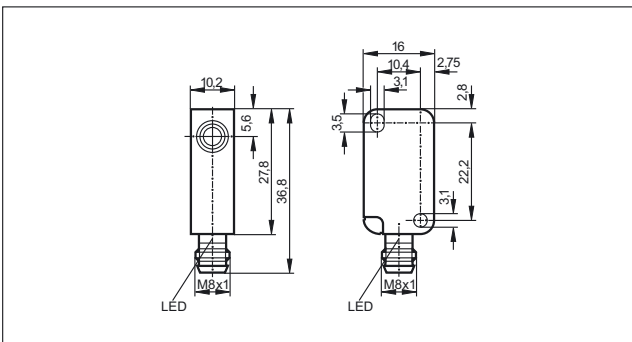

107

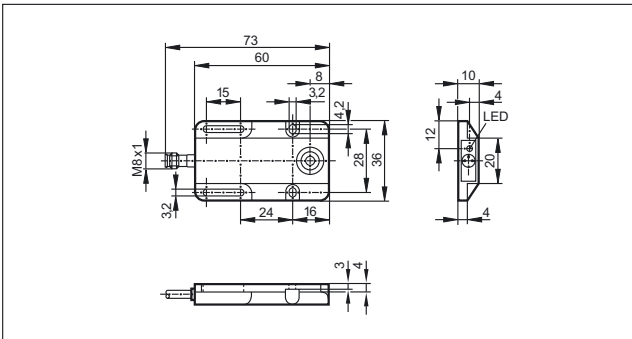

108

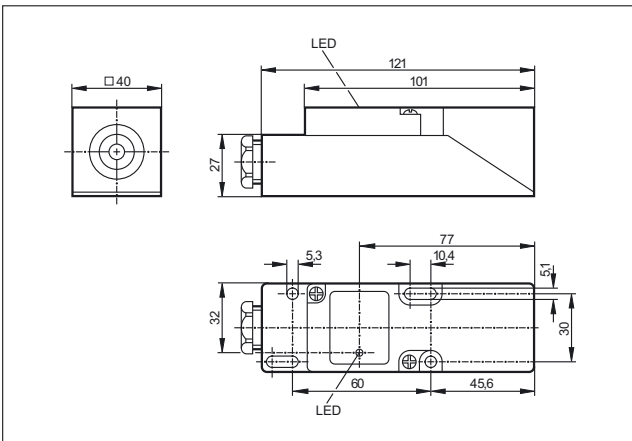

109

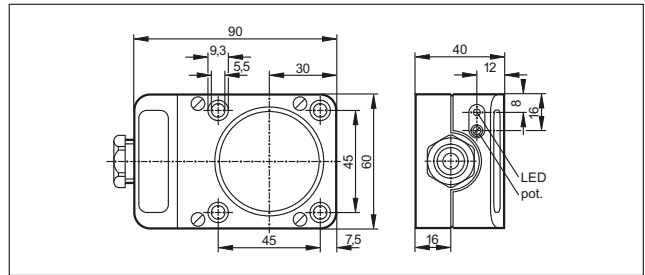

110

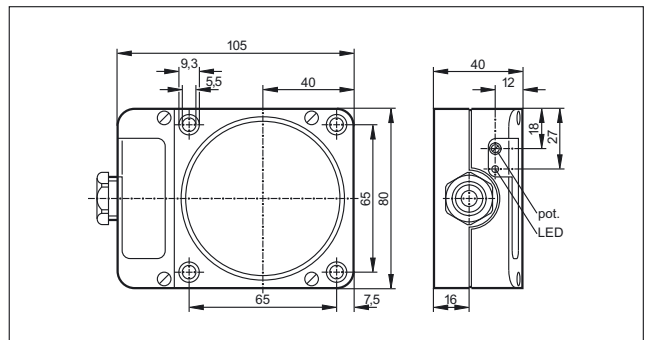

111

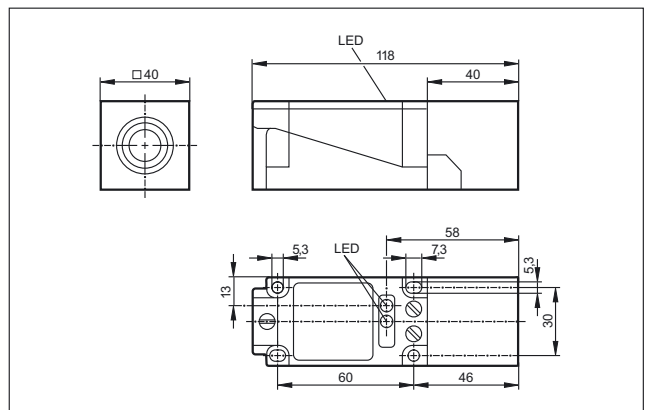

112

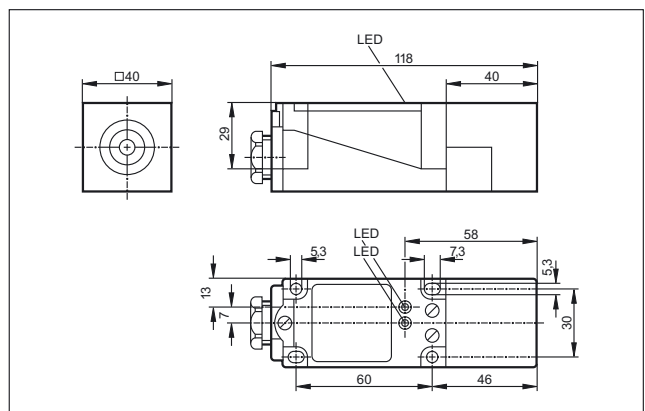

Scale drawings / drawing no. – CAD download: www.ifm.com

113

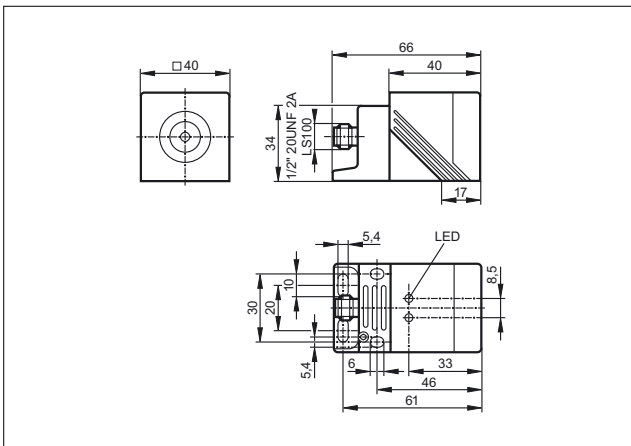

114

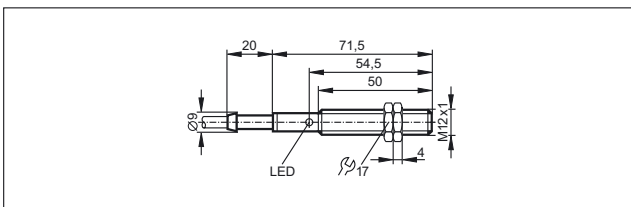

115

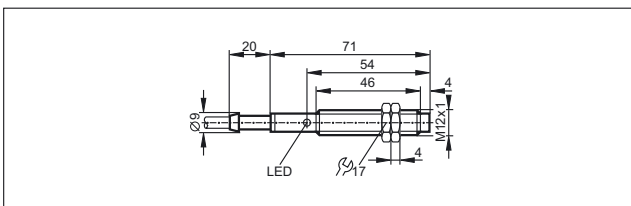

116

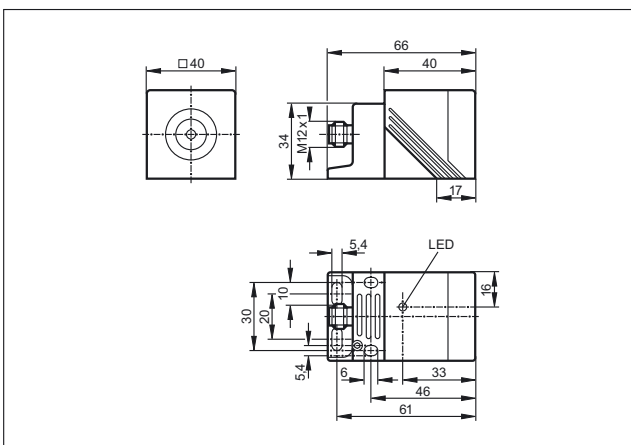

117

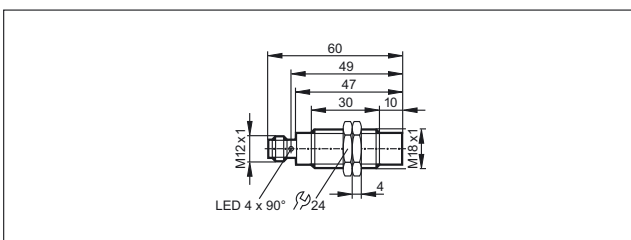

118

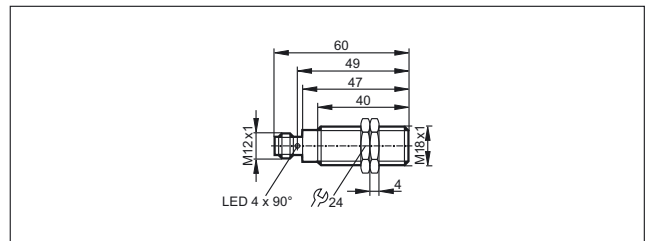

119

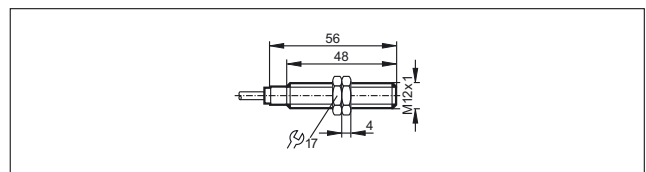

120

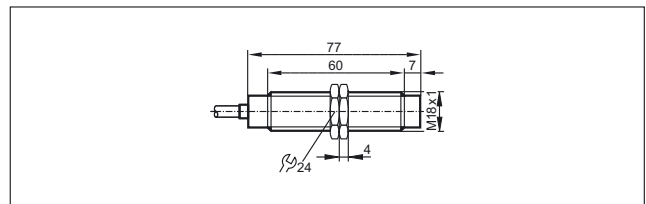

121

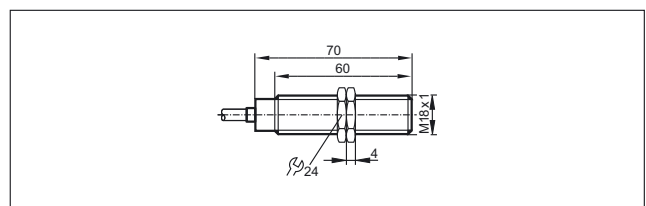

122

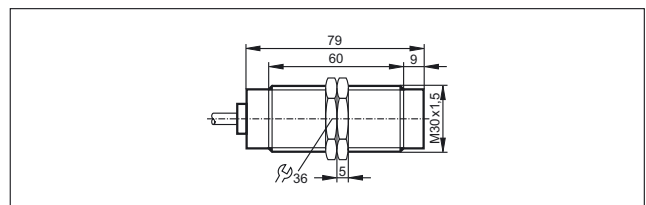

123

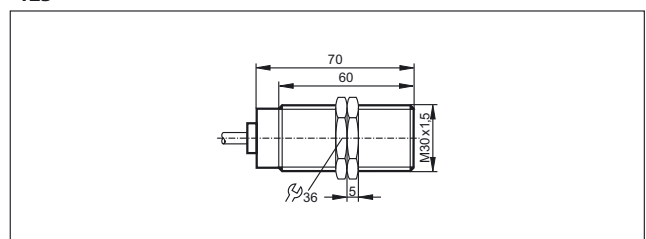

124

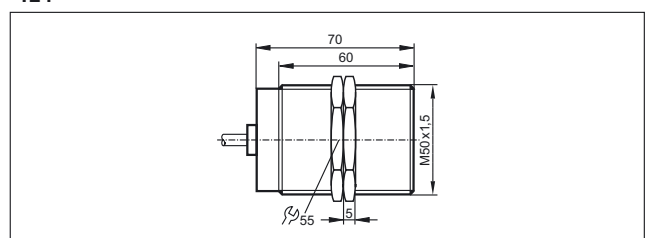

Scale drawings / drawing no. – CAD download: www.ifm.com

125

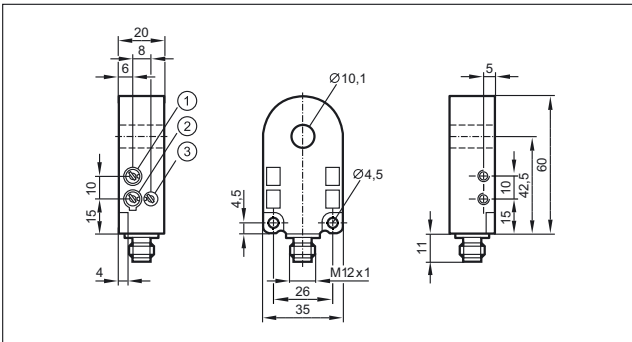

1: Sensitivity, 2: Output function, 3: Pulse stretching time

126

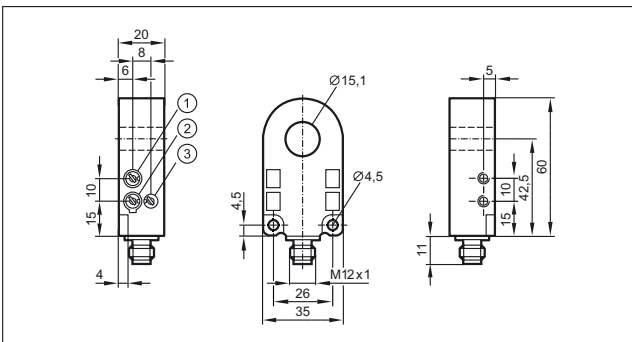

1: Sensitivity, 2: Output function, 3: Pulse stretching time

127

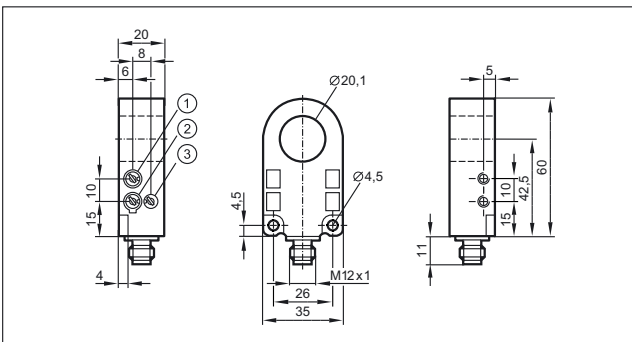

1: Sensitivity, 2: Output function, 3: Pulse stretching time

128

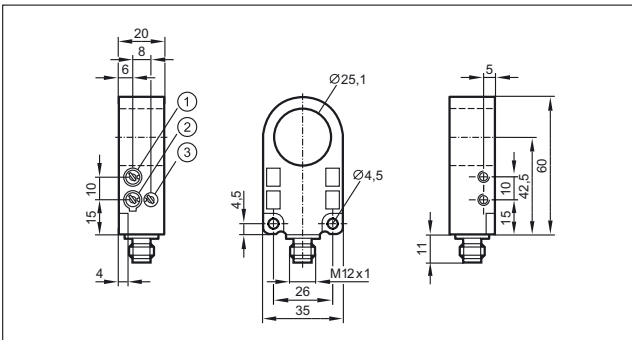

1: Sensitivity, 2: Output function, 3: Pulse stretching time

129

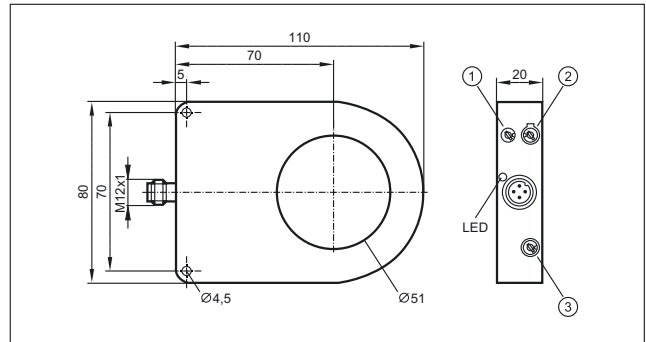

130

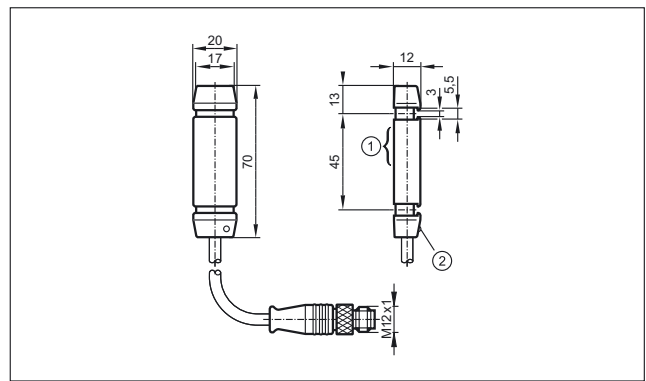

1: sensing face, 2: LED operating status

131

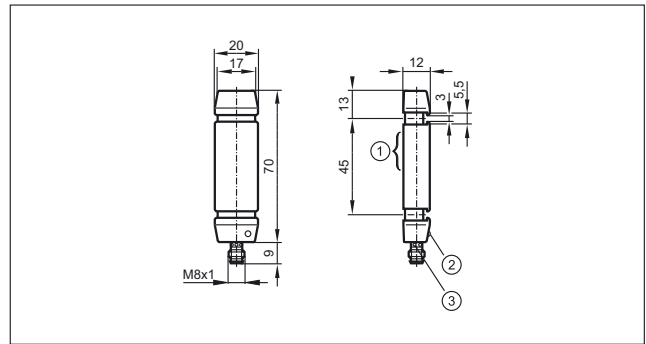

1: sensing face, 2: LED operating status, 3: LED switching status

132

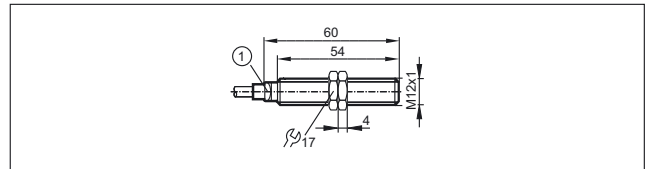

1: LED (yellow)

133

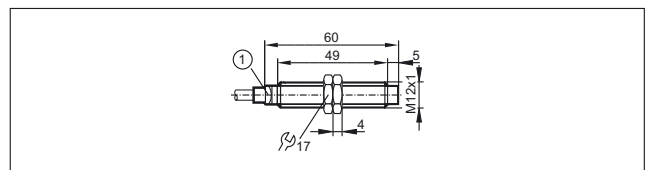

1: LED (yellow)

Scale drawings / drawing no. – CAD download: www.ifm.com

134

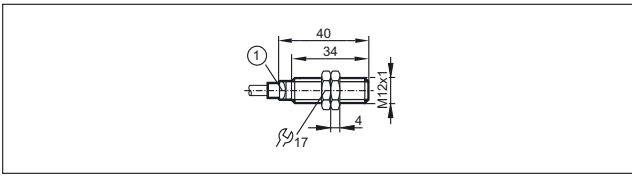

1: LED (yellow)

135

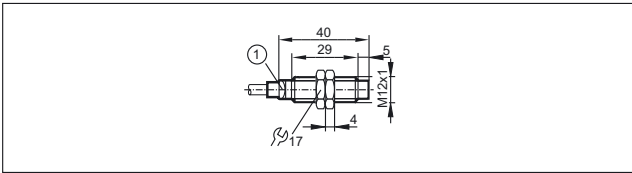

1: LED (yellow)

136

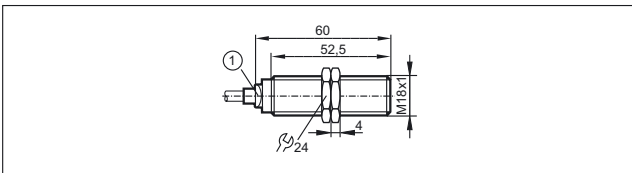

1: LED (yellow)

137

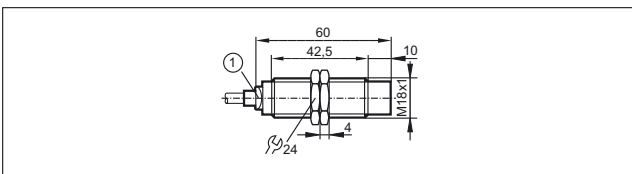

1: LED (yellow)

138

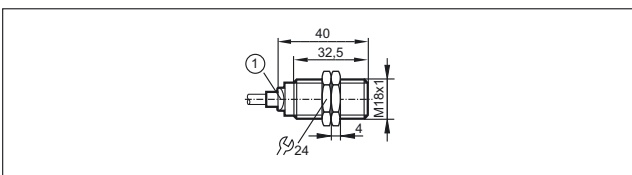

1: LED (yellow)

139

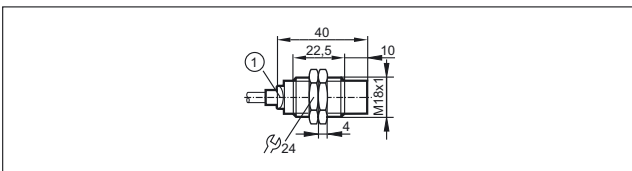

1: LED (yellow)

140

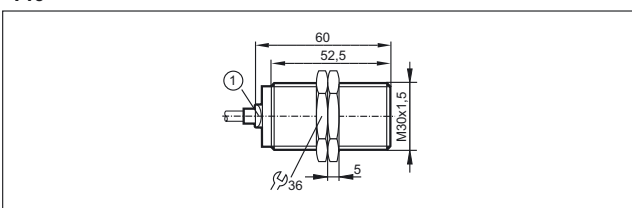

1: LED (yellow)

141

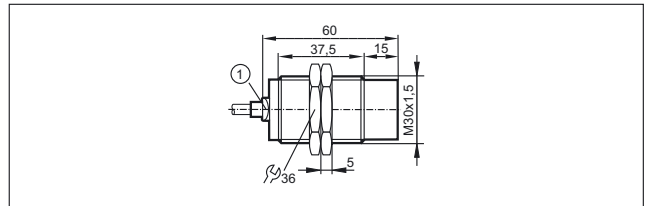

1: LED (yellow)

142

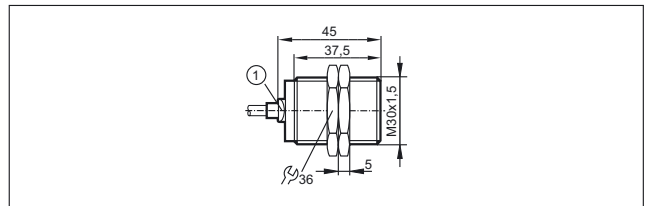

1: LED (yellow)

143

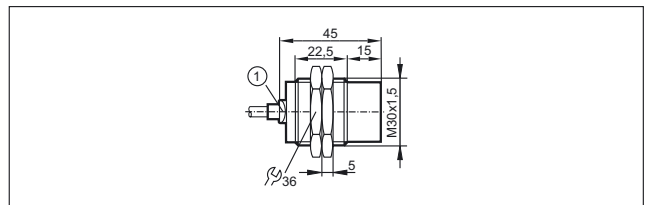

1: LED (yellow)

144

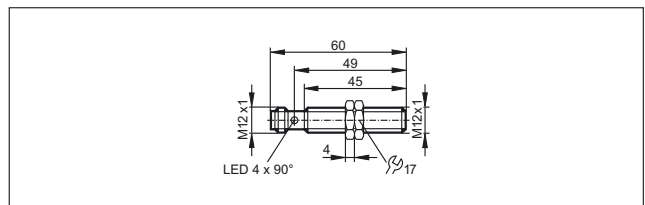

145

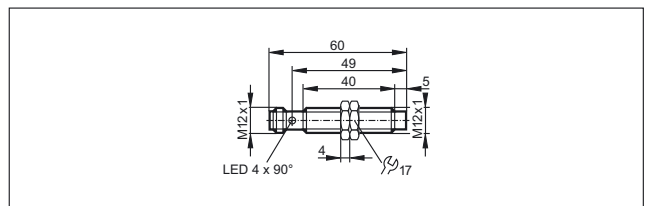

146

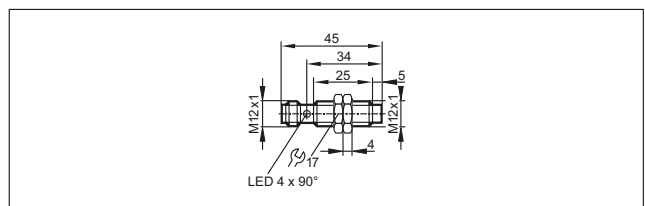

147

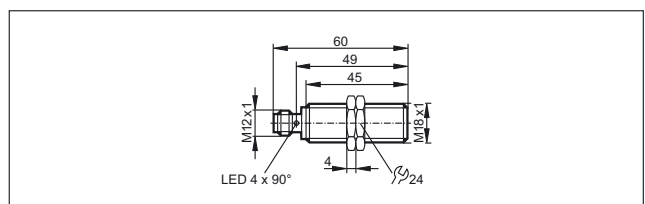

Scale drawings / drawing no. – CAD download: www.ifm.com

148

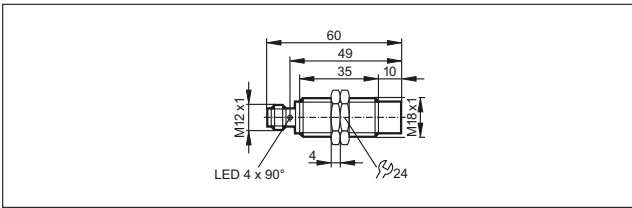

154

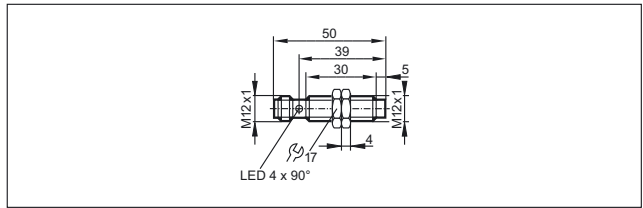

149

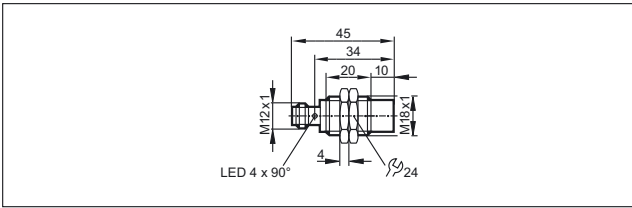

155

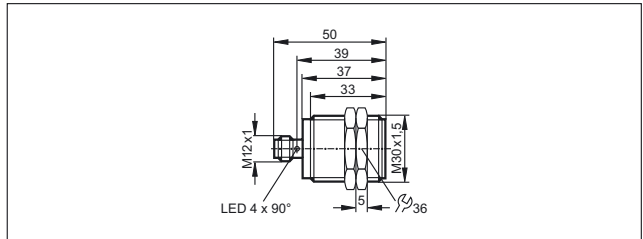

150

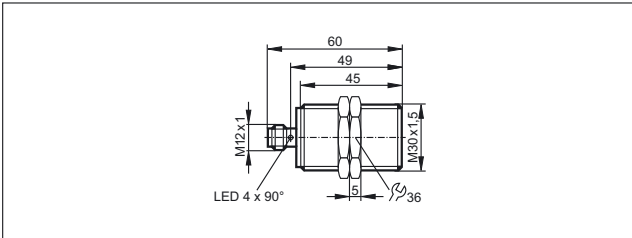

156

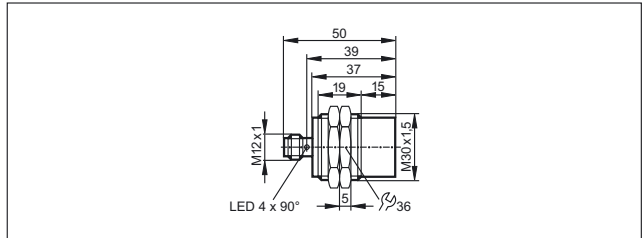

151

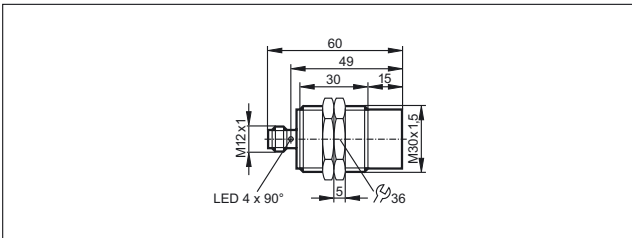

157

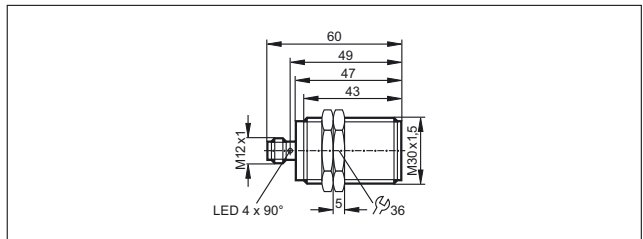

152

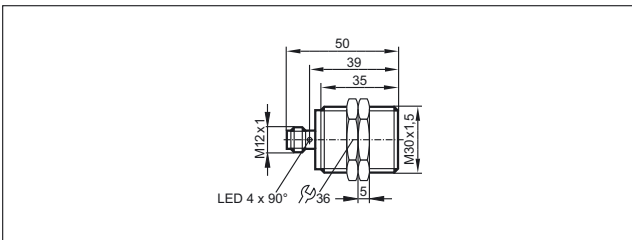

158

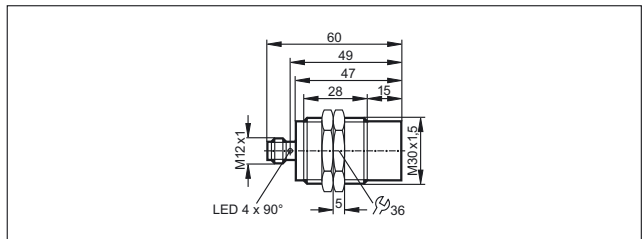

153

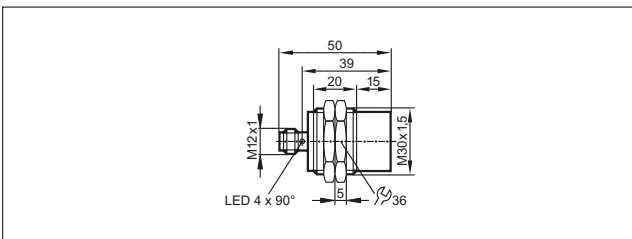

159

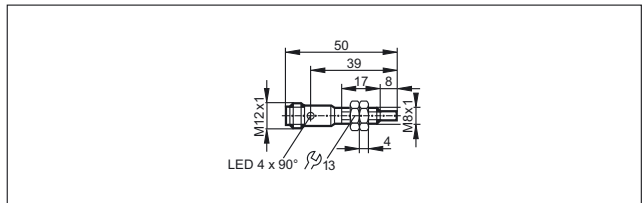

Scale drawings / drawing no. – CAD download: www.ifm.com

160

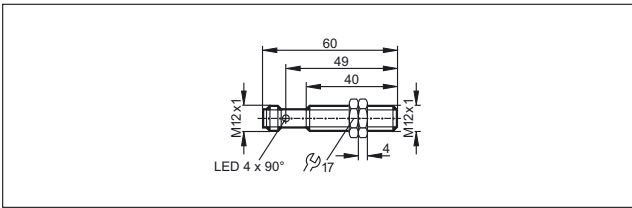

161

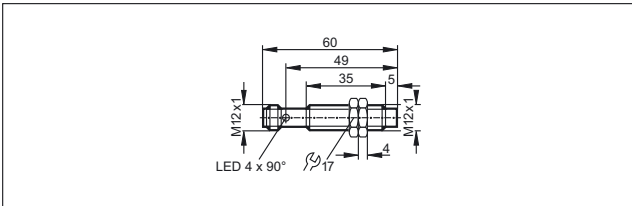

162

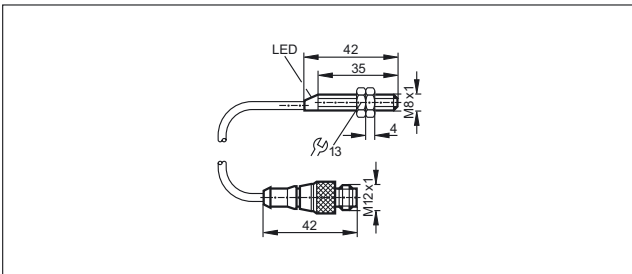

163

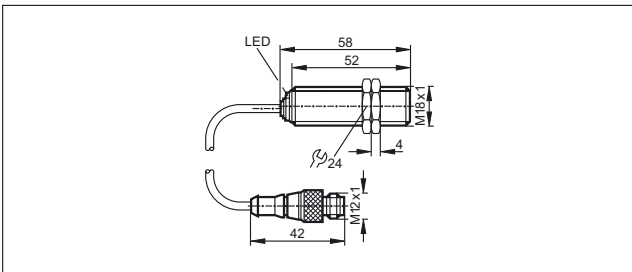

164

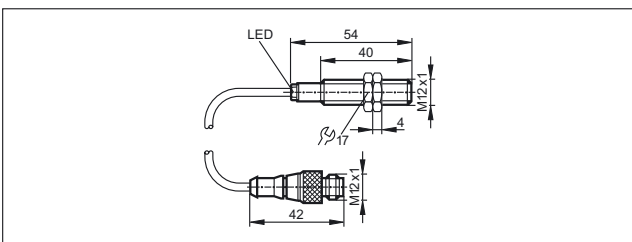

165

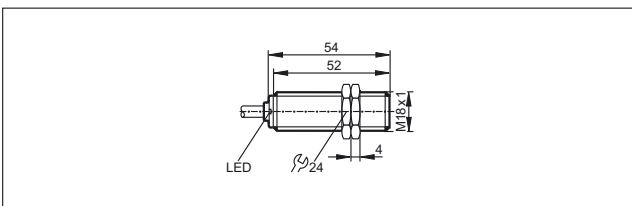

166

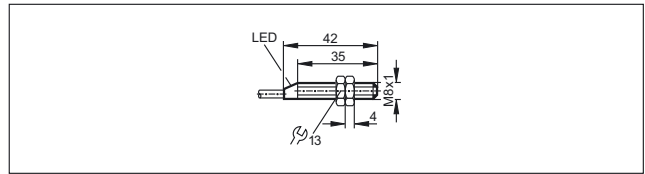

167

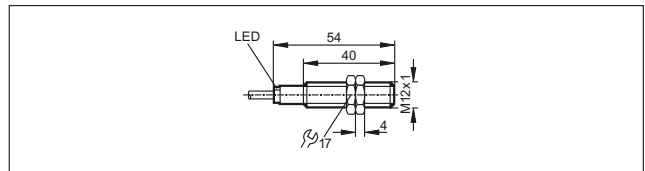

168

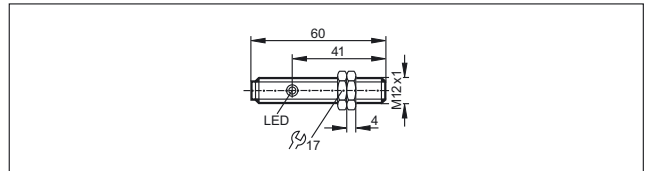

169

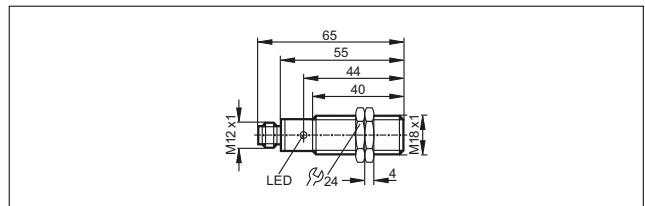

170

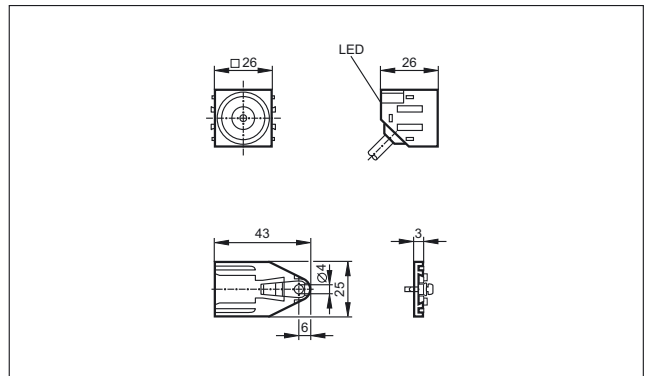

171

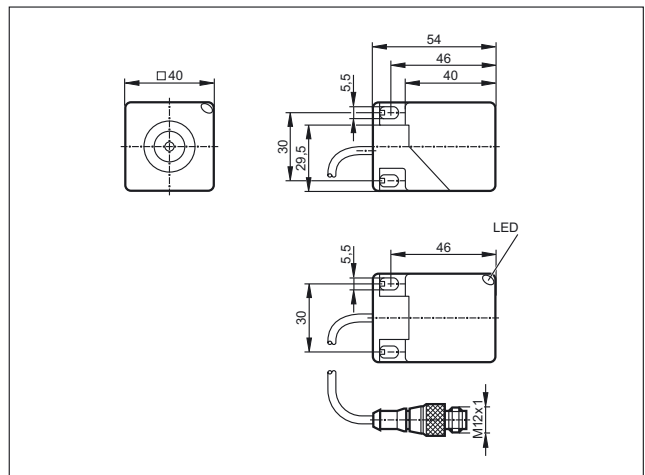

Scale drawings / drawing no. – CAD download: www.ifm.com

172

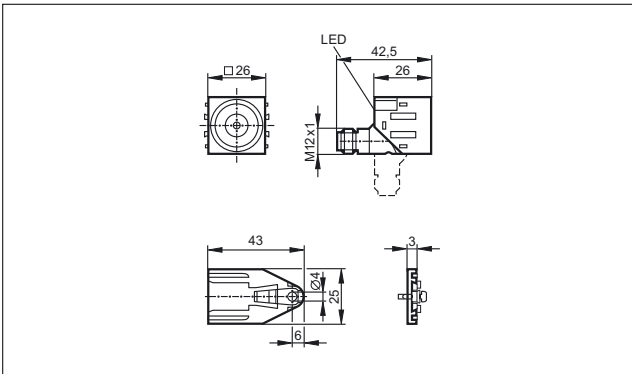

173

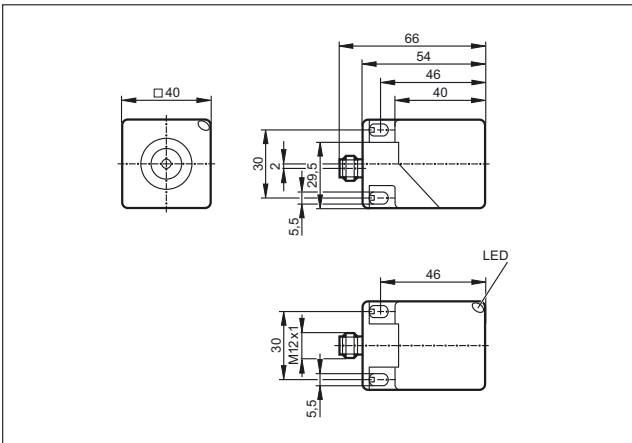

174

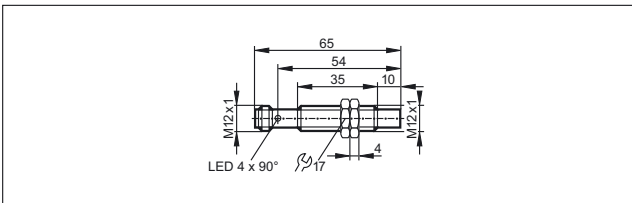

175

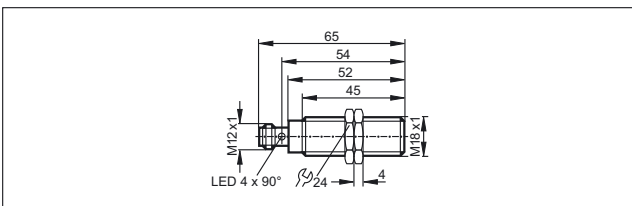

176

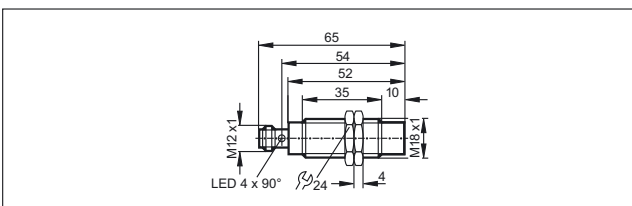

177

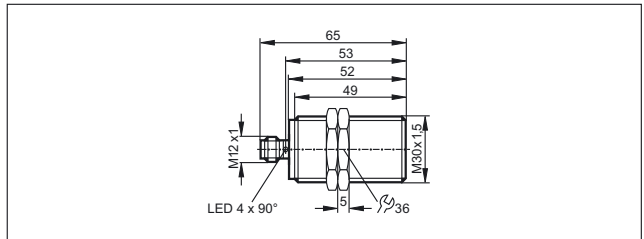

178

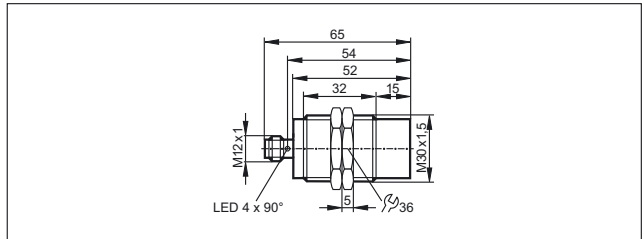

179

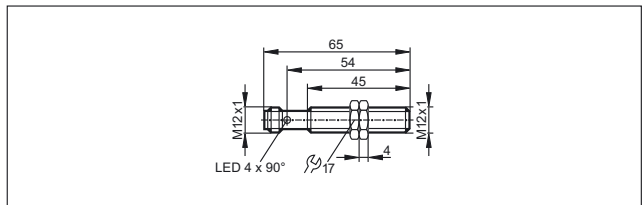

180

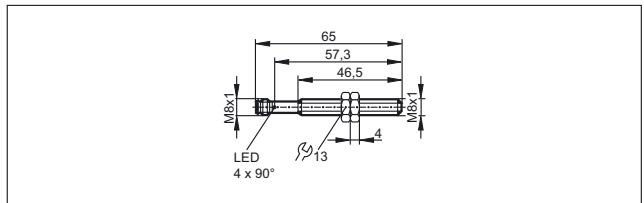

181

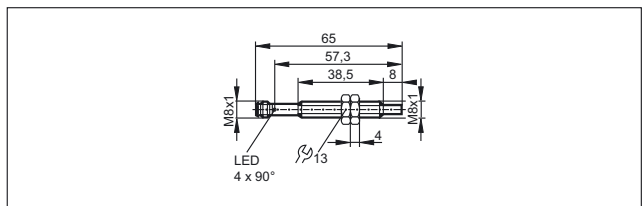

182

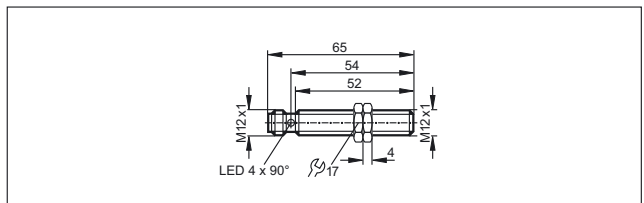

183

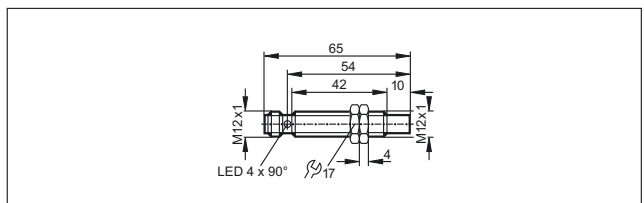

Scale drawings / drawing no. – CAD download: www.ifm.com

184

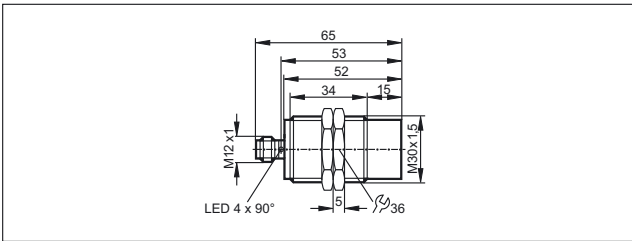

190

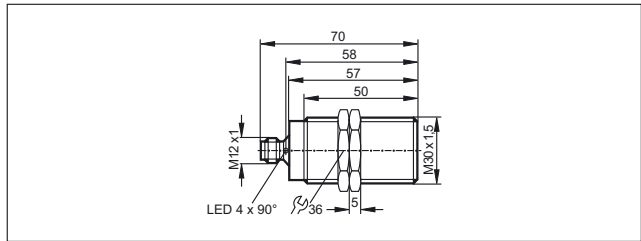

185

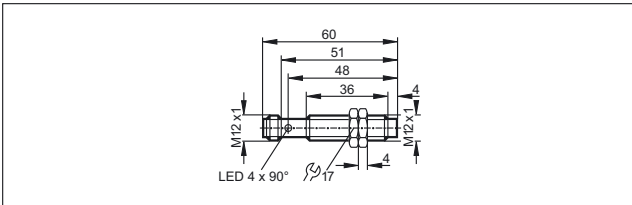

191

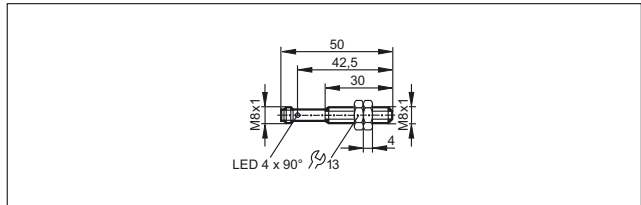

186

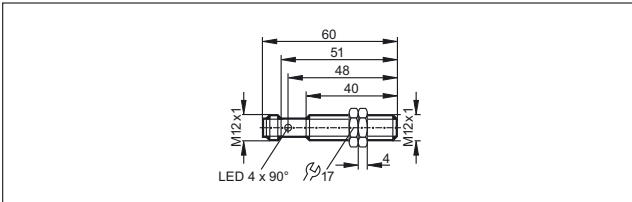

192

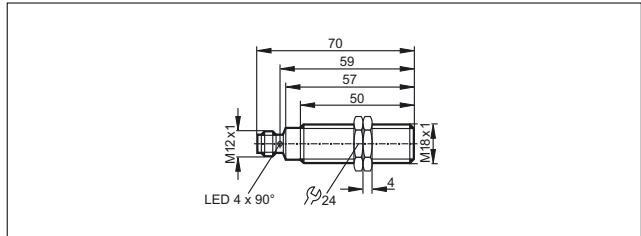

187

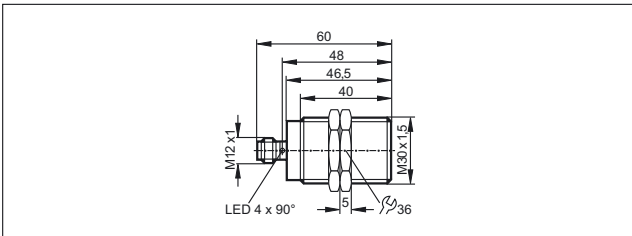

193

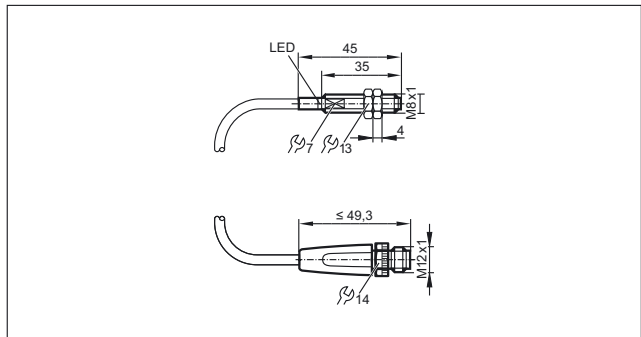

188

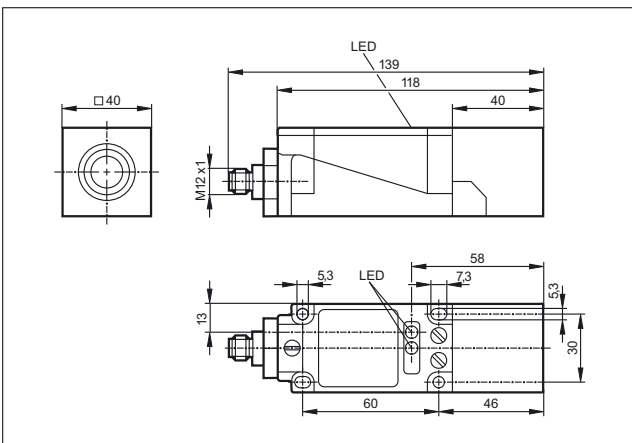

194

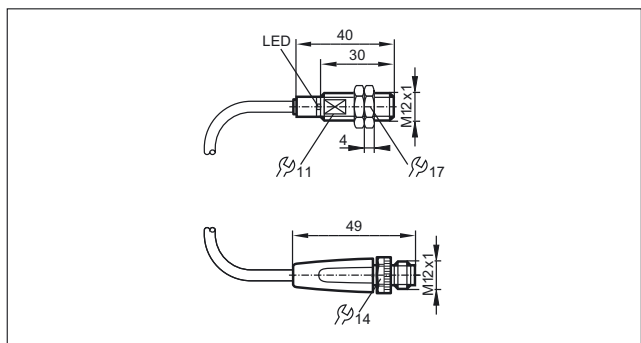

189

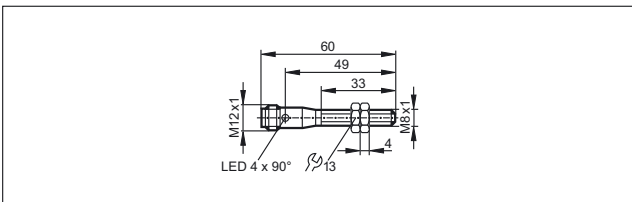

Scale drawings / drawing no. – CAD download: www.ifm.com

195

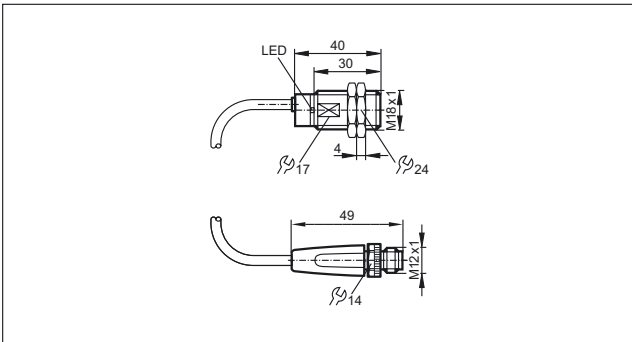

196

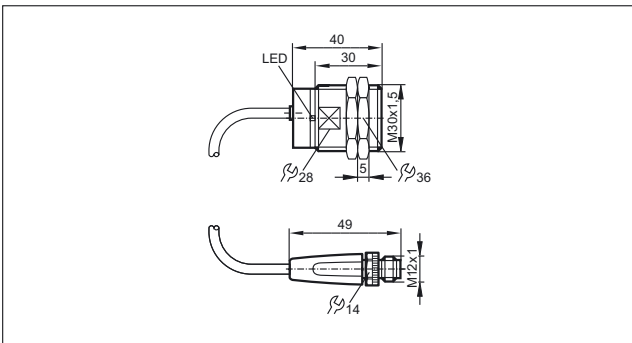

197

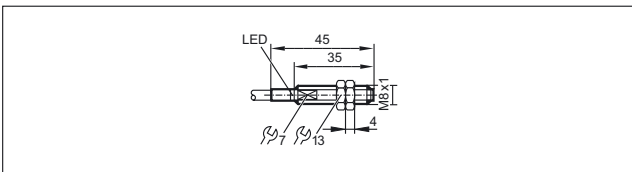

198

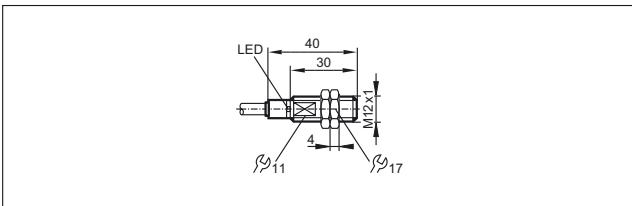

199

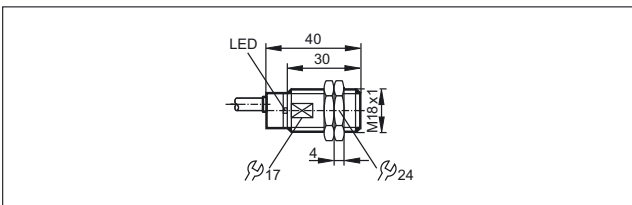

200

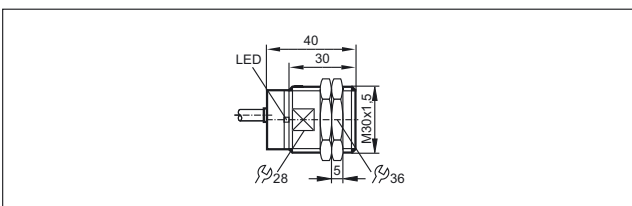

201

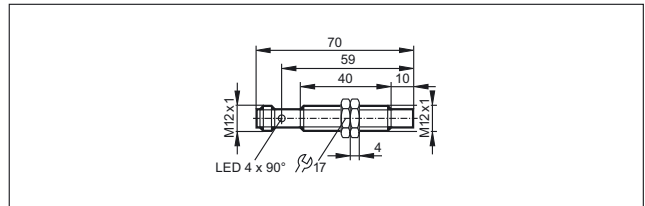

202

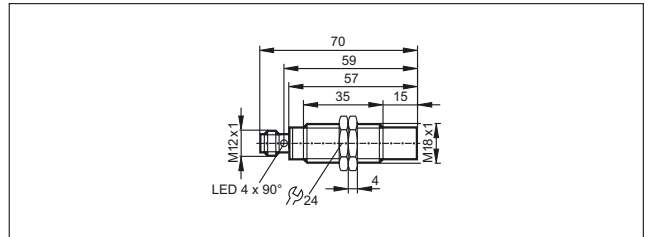

203

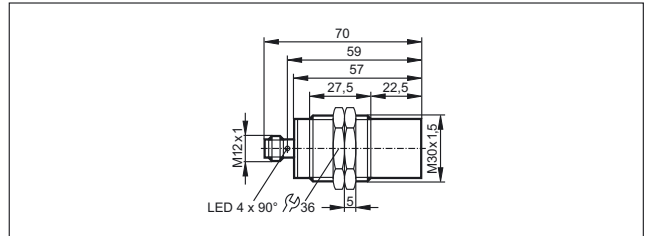

204

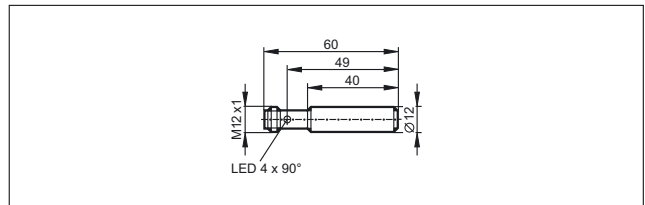

205

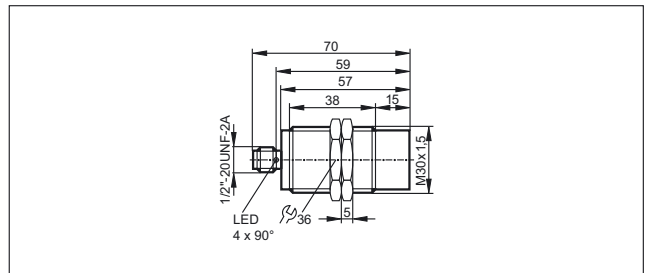

206

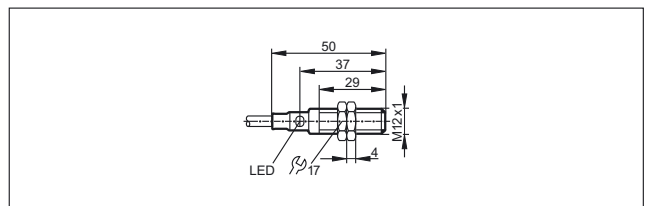

Scale drawings / drawing no. – CAD download: www.ifm.com

207

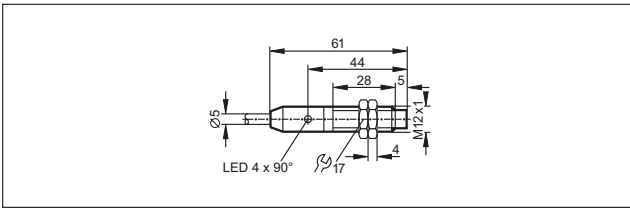

208

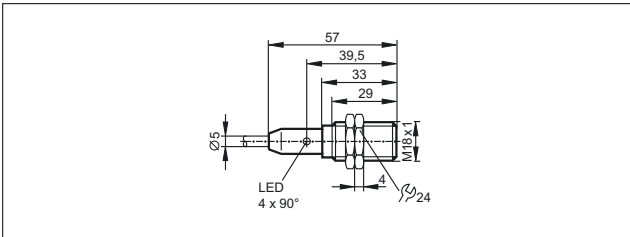

209

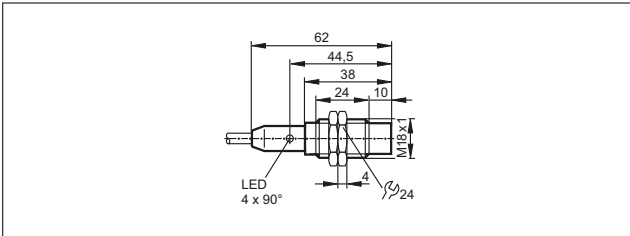

210

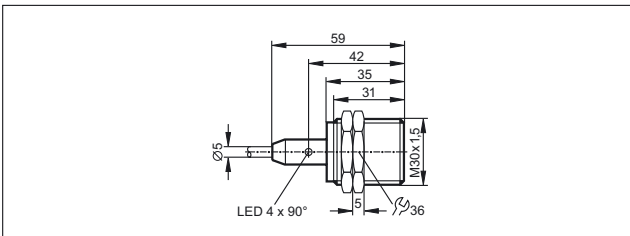

211

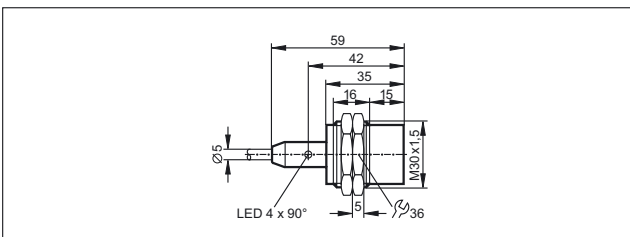

212

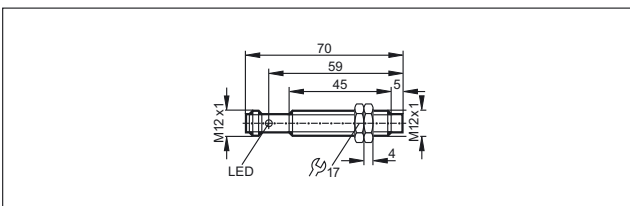

213

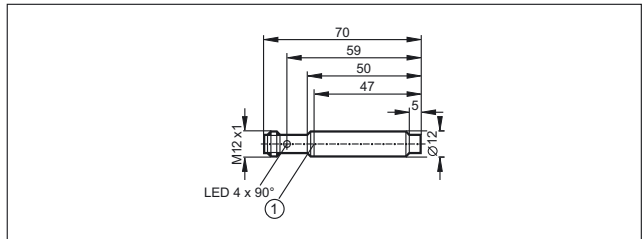

1: locating groove

214

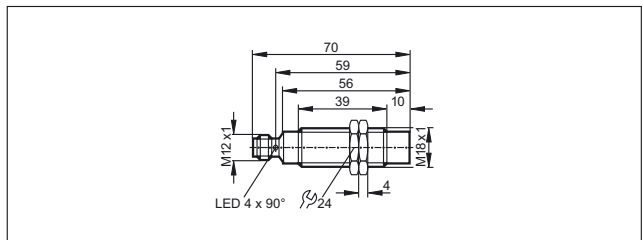

215

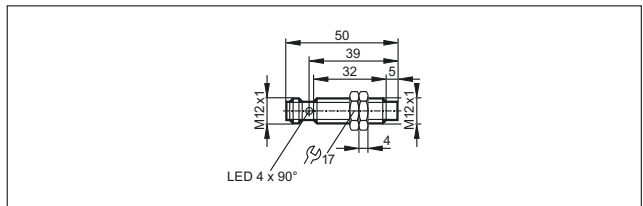

216

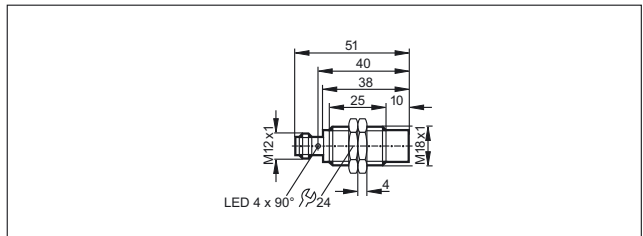

217

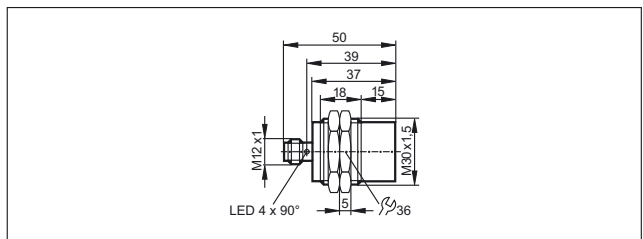

218

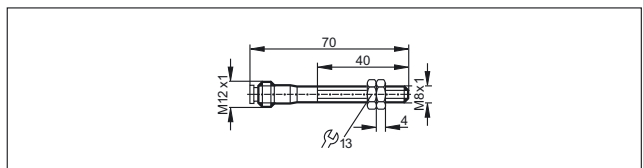

Scale drawings / drawing no. – CAD download: www.ifm.com

219

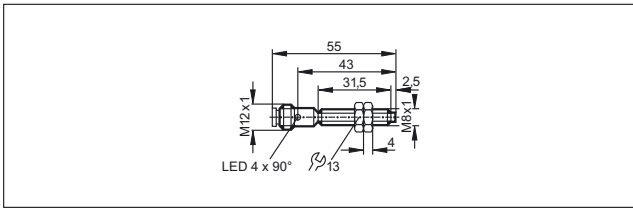

220

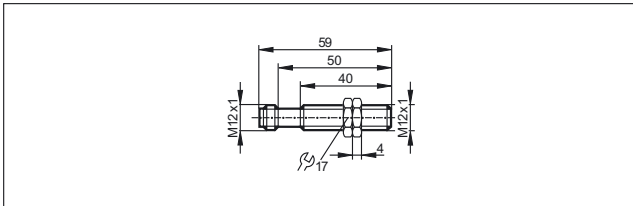

221

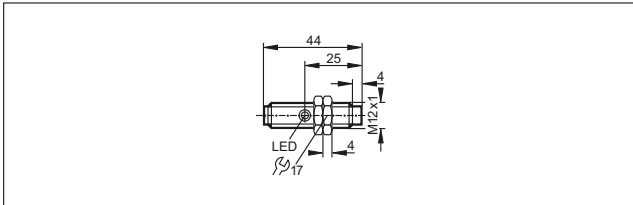

222

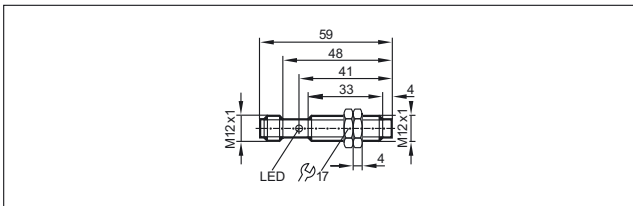

223

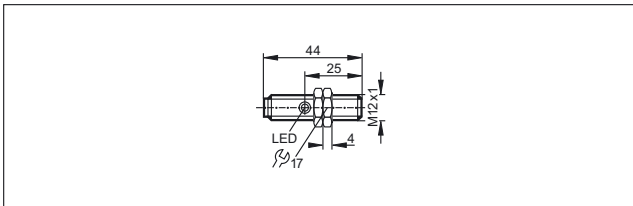

224

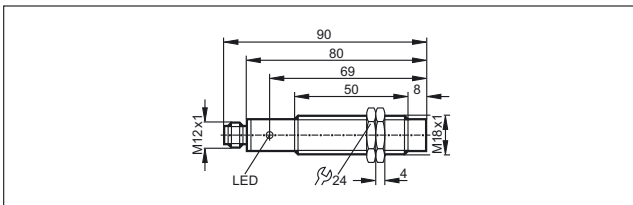

225

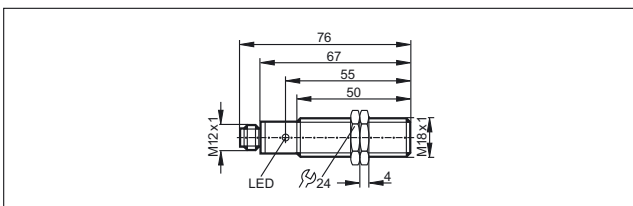

226

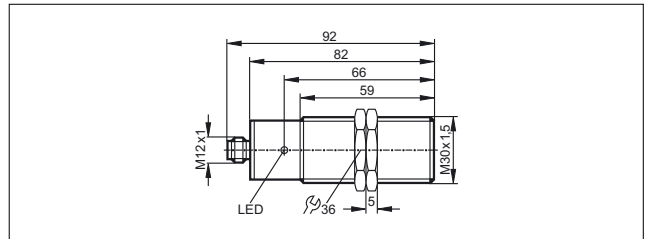

227

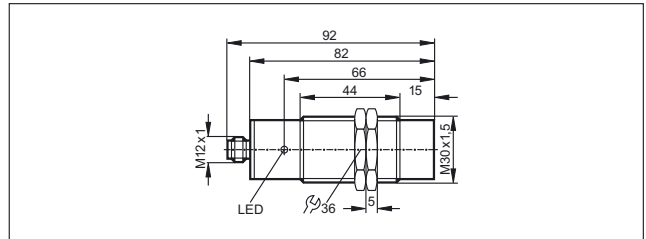

228

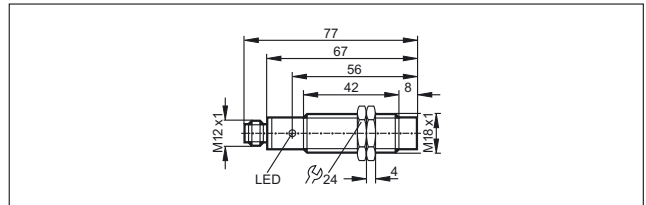

229

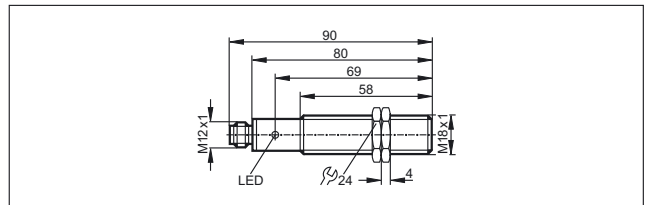

230

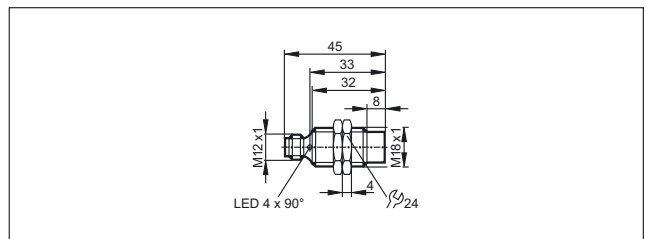

231

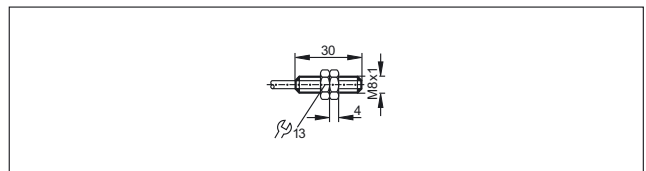

232

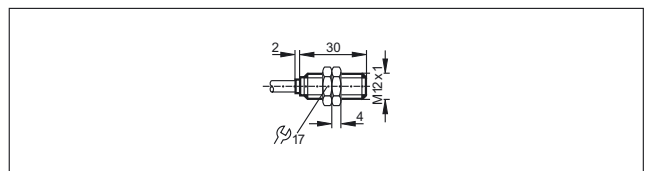

Scale drawings / drawing no. – CAD download: www.ifm.com

233

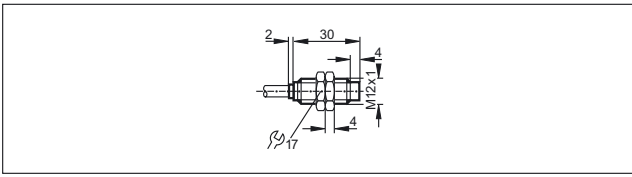

234

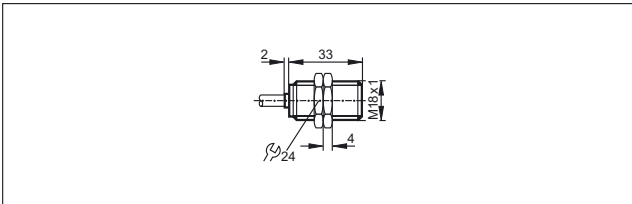

235

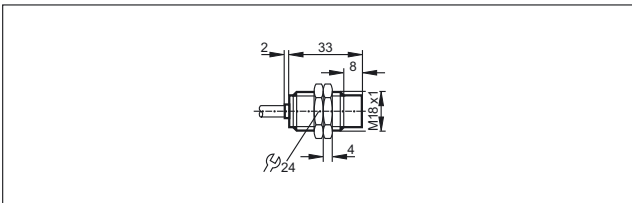

236

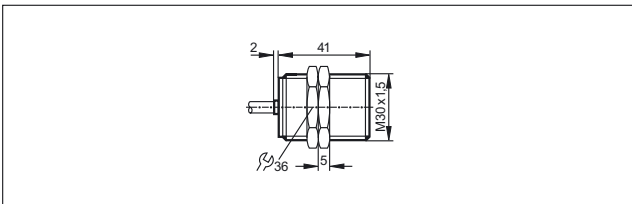

237

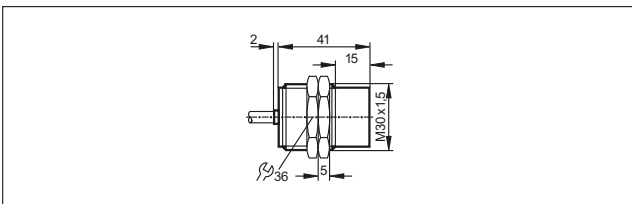

238

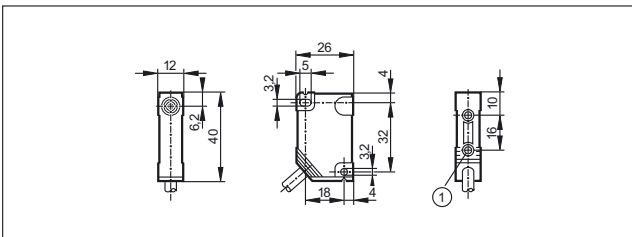

1: threaded insert M3, depth 5.8 mm, max. tightening torque 1.2 Nm (screw fixing class 8.8) when brass insert in contact with counterpart.

239

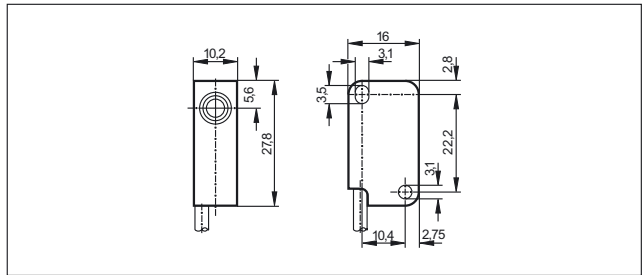

240

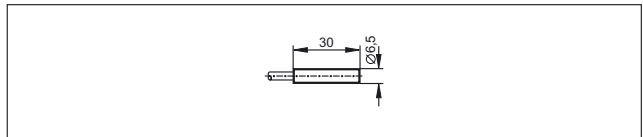

241

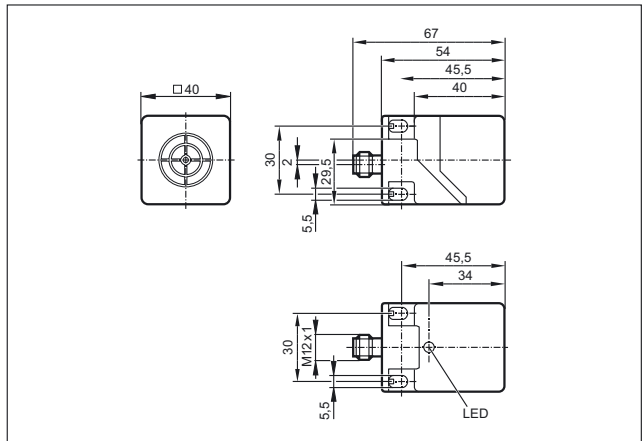

242

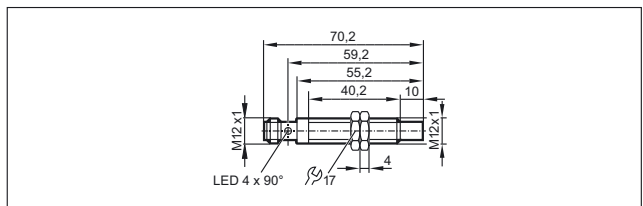

243

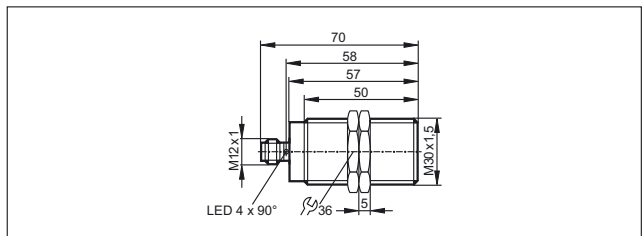

244

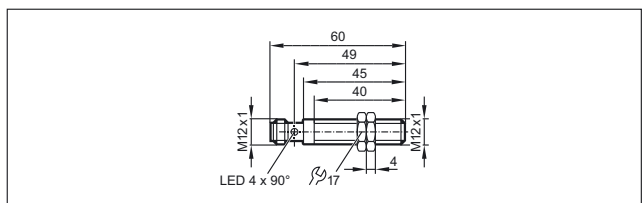

Scale drawings / drawing no. – CAD download: www.ifm.com

245

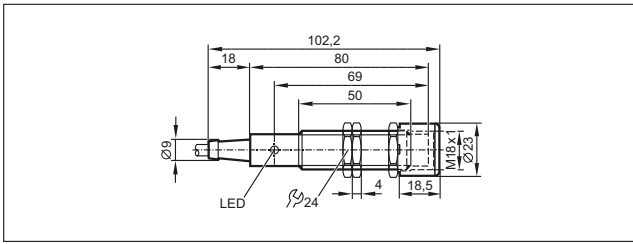

246

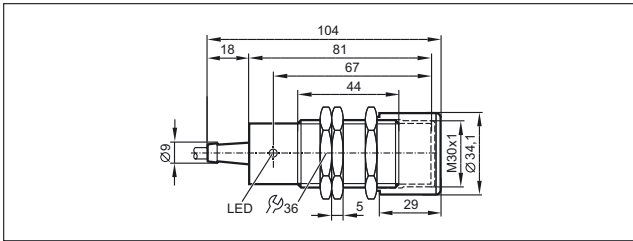

1: Sensor, 2: Sensor with protective cover

247

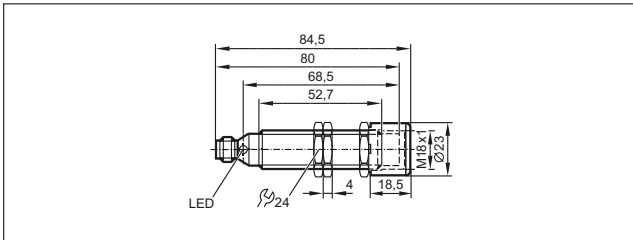

248

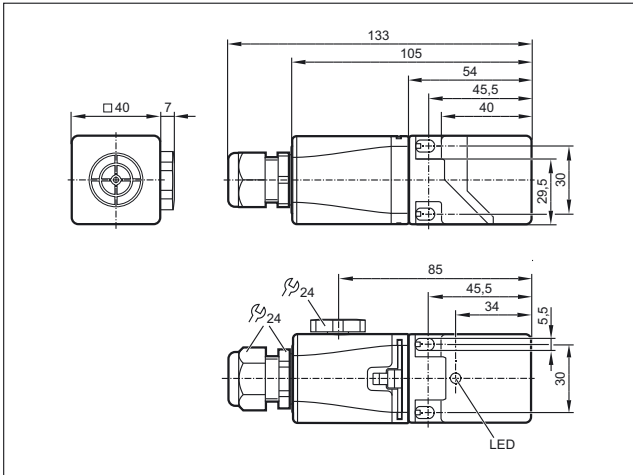

249

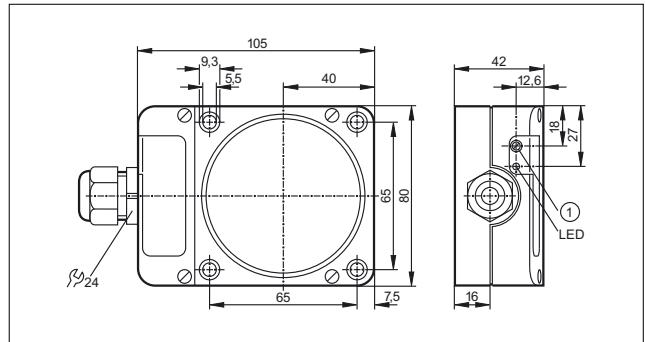

1: potentiometer

250

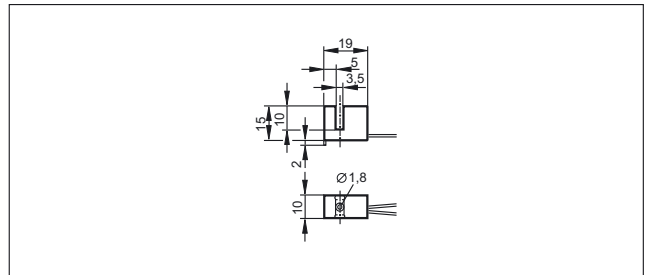

251

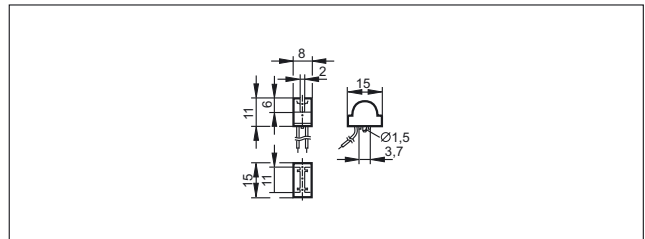

252

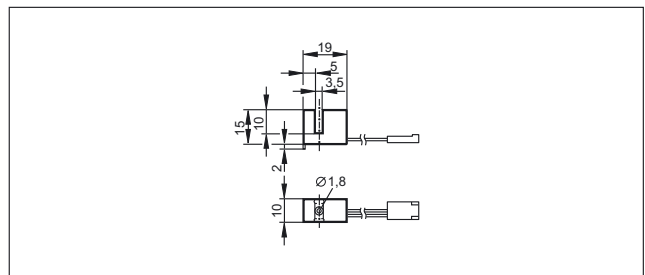



- Easy parameter setting via IO-Link before installation of the sensor
- Versatile data processing via IO-Link
- High noise immunity guarantees high operational reliability
- Plastic or metal housings
- Assortment of mounting accessories

Capacitive sensors

Capacitive sensors are used for the non-contact detection of any objects, commonly product rather than parts of the machine. In contrast to inductive sensors, capacitive sensors can detect non-metallic materials. They can also detect very small metal components at longer range than inductive sensors. Typical applications are in the wood, paper, glass, plastic, food and chemical industries. In a packaging system, capacitive sensors might monitor that the contents of a cardboard box is full, or check the presence of caps on bottles. Another example is the detection of sheets of glass on a roller conveyor.

Operating principle

The capacitance between the active electrode of the sensor and the electrical earth potential is evaluated. An approaching object influences the oscillating field between these two capacitor plates and, consequently, the capacitance. This applies to metallic and non-metallic objects. The potentiometer or pushbutton allows the user to set the sensitivity. The ability of a capacitive sensor to ignore certain materials makes them especially useful for detecting levels through sightglasses or other low density materials.

Increased noise immunity

ifm electronic has developed innovative modifications to the basic sensing principle. The patented circuit concept efficiently meets the requirements of CE marking, for example making them insensitive to electromagnetic interference which can typically occur in industry.

New characteristics via IO-Link

IO-Link allows direct detection of the process value or switch-on/switch-off delays of the output. Parameters are set via IO-Link interface.

Capacitive touch sensors

Touch sensitive switching: The capacitive touch sensors are wear-free and maintenance-free thanks to switching without pressure. They are oil-resistant, impact and scratch resistant and ingress resistant up to IP 69K. Their operating principle is dynamic, static or latching. They are typically used in industrial applications or on mobile machines as start / stop buttons or enable switches.

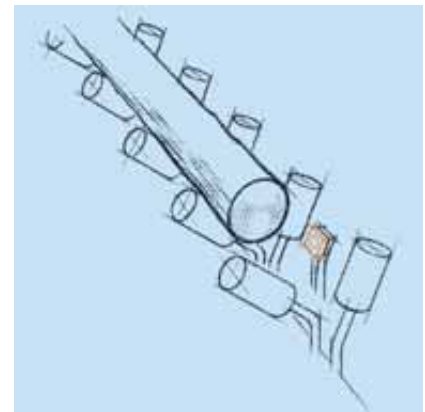



Not only metal:
Capacitive sensors
detect almost all
materials, here
for example a log
in a saw mill.

System overview	Page
Sensors for level and position detection DC	152 - 154
Sensors for level and position detection AC/DC	154 - 155
Sensors with IO-Link	155 - 156
Sensors with ATEX approval	156 - 157
Switching amplifiers with ATEX approval	157 - 158
Dynamic capacitive touch sensors	158 - 159
Static capacitive touch sensors	159
Capacitive touch sensors with latching evaluation principle	160
Accessories	160 - 161
Accessories mounting adapters	161 - 162
Accessories mounting components	162
Wiring diagrams	162 - 164
Scale drawings / drawing no. – CAD download: www.ifm.com	164 - 168

Sensors for level and position detection DC

Type	Dimensions [mm]	Sensing range [mm]	Material	U _b [V]	Protection	f [Hz]	I _{load} [mA]	Drawing no.	Order no.
------	--------------------	-----------------------	----------	-----------------------	------------	-----------	---------------------------	-------------	-----------

Cable 2 m · Output function  · DC PNP · Wiring diagram no. 1

	M12 / L = 69	4 f	high-grade stainless steel	10...36	IP 65	50	100	1	KF5014
	M12	8 nf	high-grade stainless steel	10...36	IP 65	50	100	2	KF5015
	M18 / L = 84	8 nf	PBT	10...36	IP 67	50	250	3	KG5043
	M30 / L = 81	15 nf	PBT	10...36	IP 65	40	250	4	KI5002
	120 x 80 x 30	60 nf	modified PPO	10...36	IP 65	10	250	5	KD5022

Cable 2 m · Output function  · DC PNP/NPN · Wiring diagram no. 19

	M18 / L = 84	8 nf	PBT	10...55	IP 67	50	250	3	KG5047
---	--------------	------	-----	---------	-------	----	-----	---	--------

Cable 2 m · Output function  · DC NPN · Wiring diagram no. 2

	M30 / L = 81	15 nf	PBT	10...36	IP 65	40	250	4	KI5015
---	--------------	-------	-----	---------	-------	----	-----	---	--------

Cable 2 m · Output function  · DC NPN · Wiring diagram no. 3

	M30 / L = 81	15 nf	PBT	10...36	IP 65	40	250	4	KI5019
---	--------------	-------	-----	---------	-------	----	-----	---	--------

Cable 2 m · Output function  · DC PNP · Wiring diagram no. 20









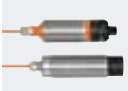













	M30 / L = 81	15 nf	PBT	10...36	IP 65	40	250	4	KI5207
---	--------------	-------	-----	---------	-------	----	-----	---	--------

Cable 2 m · Output function  · DC PNP · Wiring diagram no. 4

	M18 / L = 77	8 nf	PP	10...36	IP 65 / IP 67	10	200	6	KG5069
---	--------------	------	----	---------	---------------	----	-----	---	--------





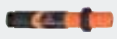

M12 connector · Output function  · DC PNP · Wiring diagram no. 21 · Connector groups 8, 10, 18, 20, 120, 124, 126, 128, 157

	M30 / L = 116	nf	PPS	10...30	IP 67	10	200	7	KN5121
---	---------------	----	-----	---------	-------	----	-----	---	--------

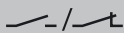
Type	Dimensions [mm]	Sensing range [mm]	Material	U _b [V]	Protection	f [Hz]	I _{load} [mA]	Drawing no.	Order no.
M12 connector · Output function  · DC PNP · Wiring diagram no. 5 · Connector groups 8, 10, 11, 18, 20, 120, 124, 126, 128, 130, 157, 158									
	M18 / L = 93.8	8 nf	PBT	10...36	IP 67	50	250	8	KG5057
M12 connector · Output function  /  · DC PNP · Wiring diagram no. 6 · Connector groups 8, 10, 11, 18, 20, 120, 124, 126, 128, 130, 157, 158									
	M18 / L = 87	12 nf	PBT	10...36	IP 65 / IP 67	10	200	9	KG5066
	M18 / L = 87	8 nf	PBT	10...36	IP 65 / IP 67	10	200	9	KG5071
	M30 / L = 90	20 nf	PBT	10...36	IP 65 / IP 67	10	200	10	KI5083
M12 connector · Output function  /  · DC PNP/NPN · Wiring diagram no. 22 · Connector groups 8, 10, 11, 18, 20, 120, 124, 126, 128, 130, 157, 158									
	M30 / L = 90	20 nf	PBT	10...36	IP 65 / IP 67	10	200	10	KI5082
M12 connector · Output function  /  · DC PNP · Wiring diagram no. 23 · Connector groups 8, 10, 11, 18, 20, 120, 124, 126, 128, 130, 157, 158									
	105 x 80 x 40	60 nf	modified PPO	10...36	IP 65	10	250	11	KD5039
M12 connector · Output function  · DC PNP · Wiring diagram no. 6 · Connector groups 8, 10, 18, 20, 120, 124, 126, 128, 157									
	M12 / L = 60	4 f	High-grade st. steel	10...36	IP 65	50	100	12	KF5001
	M12 / L = 61	8 nf	High-grade st. steel	10...36	IP 65	50	100	13	KF5002
M12 connector · Output function  · DC NPN · Wiring diagram no. 7 · Connector groups 8, 10, 18, 20, 120, 124, 126, 128, 157									
	M12 / L = 60	4 f	High-grade st. steel	10...36	IP 65	50	100	12	KF5013
M12 connector · Output function  /  · DC PNP · Wiring diagram no. 6 · Connector groups 8, 10, 18, 20, 120, 124, 126, 128, 157									
	M30 / L = 90	8 f	High-grade st. steel	10...30	IP 65 / IP 67	10	100	14	KI5085
	M30 / L = 90	15 nf	High-grade st. steel	10...30	IP 65 / IP 67	10	100	15	KI5087
Terminals · Output function  · DC PNP · Wiring diagram no. 8									
	M18 / L = 110	8 nf	PBT	10...36	IP 65	50	250	16	KG5041

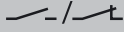

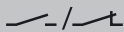
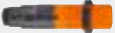
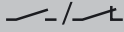



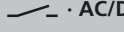

You can find wiring diagrams and scale drawings from page 162

Position sensors

Type	Dimensions [mm]	Sensing range [mm]	Material	U _b [V]	Protection	f [Hz]	I _{load} [mA]	Draw- ing no.	Order no.
Terminals · Output function  · DC PNP/NPN · Wiring diagram no. 24									
	M18 / L = 110	8 nf	PBT	10...55	IP 65	50	200	16	KG5040
Terminals · Output function  · DC PNP · Wiring diagram no. 9									
	M30 / L = 125	15 nf	PBT	10...55	IP 65	40	250	17	KI5023
Terminals · Output function  · DC NPN · Wiring diagram no. 10									
	M30 / L = 125	15 nf	PBT	10...36	IP 65	40	250	17	KI5024
Terminals · Output function  · DC PNP · Wiring diagram no. 25									
	105 x 80 x 40	60 nf	modified PPO	10...36	IP 65	10	250	18	KD5018

f = flush / nf = non flush

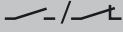
Sensors for level and position detection AC/DC

Type	Dimensions [mm]	Sensing range [mm]	Material	U _b [V]	Protection	f AC / DC [Hz]	I _{load} AC / DC [mA]	Draw- ing no.	Order no.
Cable 2 m · Output function  · AC/DC · Wiring diagram no. 11									
	M18 / L = 84	8 nf	PBT	20...250	IP 67	25 / 50	150 / 100	3	KG0009*
	M30 / L = 81	15 nf	PBT	20...250	IP 65	25 / 40	200	4	KI0016*
	120 x 80 x 30	60 nf	modified PPO	20...250	IP 65	10	200	5	KD0012*
Cable 2 m · Output function  · AC/DC · Wiring diagram no. 12									
	M18 / L = 84	8 nf	PBT	20...250	IP 67	25 / 50	150 / 100	3	KG0010*
	M30 / L = 81	15 nf	PBT	20...250	IP 65	25 / 40	200	4	KI0020*
1/2" UNF-Connector · Output function  · AC/DC · Wiring diagram no. 13 · Connector group 29									
	M18 / L = 87	12 nf	PBT	20...250	IP 65 / IP 67	10	100	19	KG0016*

Product selectors and further information can be found at: www.ifm.com

Type	Dimensions [mm]	Sensing range [mm]	Material	U _b [V]	Protection	f AC / DC [Hz]	I _{load} AC / DC [mA]	Draw- ing no.	Order no.
------	--------------------	--------------------------	----------	-----------------------	------------	----------------------	--------------------------------------	---------------------	--------------

 1/2" UNF-Connector · Output function  · AC/DC · Wiring diagram no. 13 · Connector group 29

	M30 / L = 90	20 nf	PBT	20...250	IP 65 / IP 67	10	100	20	KI0054*
---	--------------	-------	-----	----------	---------------	----	-----	----	---------

 Terminals · Output function  · AC/DC · Wiring diagram no. 14

	M18 / L = 110	8 nf	PBT	20...250	IP 65	25 / 50	150 / 100	16	KG0008*
---	---------------	------	-----	----------	-------	---------	-----------	----	---------

	M30 / L = 125	15 nf	PBT	20...250	IP 65	25 / 40	200	17	KI0024*
---	---------------	-------	-----	----------	-------	---------	-----	----	---------

 Terminals · Output function  · AC/DC · Wiring diagram no. 26

	105 x 80 x 40	60 nf	modified PPO	20...250	IP 65	10	200	18	KD0009*
---	---------------	-------	--------------	----------	-------	----	-----	----	---------

f = flush / nf = non flush

*** Note for AC and AC/DC units**

Miniature fuse to IEC60127-2 sheet 1, ≤ 2 A (fast acting) Recommendation: check the unit for reliable function after a short circuit.

Sensors with IO-Link

Type	Dimensions [mm]	Sensing range [mm]	Material	U _b [V]	Protection	f [Hz]	I _{load} [mA]	Draw- ing no.	Order no.
------	--------------------	--------------------------	----------	-----------------------	------------	-----------	---------------------------	---------------------	--------------

 Cable 2 m · Output function  · DC PNP/NPN · Wiring diagram no. 27

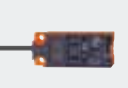
	20 x 14 x 48	12 nf	PBT	10...30	IP 65 / IP 67	10	100	21	KQ6001
---	--------------	-------	-----	---------	---------------	----	-----	----	--------

 Cable 2 m · Output function  · DC PNP · Wiring diagram no. 4



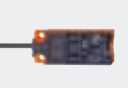

	20 x 7 x 48	12 nf	PBT	10...30	IP 65 / IP 67	10	100	22	KQ5100
---	-------------	-------	-----	---------	---------------	----	-----	----	--------

	20 x 14 x 48	12 nf	PBT	10...30	IP 65 / IP 67	10	100	21	KQ6002
---	--------------	-------	-----	---------	---------------	----	-----	----	--------

 Cable 2 m · Output function  · DC NPN · Wiring diagram no. 15

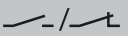
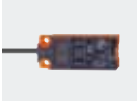
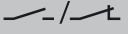
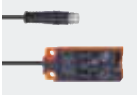
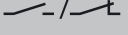
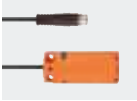
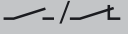

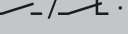



	20 x 14 x 48	12 nf	PBT	10...36	IP 65 / IP 67	10	100	23	KQ6006
---	--------------	-------	-----	---------	---------------	----	-----	----	--------

Position sensors

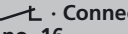
Type	Dimensions [mm]	Sensing range [mm]	Material	U _b [V]	Protection	f [Hz]	I _{load} [mA]	Drawing no.	Order no.
Cable 10 m · Output function  · DC PNP · Wiring diagram no. 4									
	20 x 14 x 48	12 nf	PBT	10...36	IP 65 / IP 67	10	100	23	KQ6007
Cable with connector 0.04 m · Output function  · DC PNP/NPN · Wiring diagram no. 22 · Connector groups 4, 5, 124									
	20 x 14 x 48	12 nf	PBT	10...30	IP 65 / IP 67	10	100	24	KQ6003
Cable with connector 0.04 m · Output function  · DC PNP · Wiring diagram no. 6 · Connector groups 1, 2, 3, 72, 78, 120, 122									
	20 x 7 x 48	12 nf	PBT	10...30	IP 65 / IP 67	10	100	25	KQ5102
Cable with connector 0.04 m · Output function  · DC PNP · Wiring diagram no. 6 · Connector groups 4, 5, 124									
	20 x 14 x 48	12 nf	PBT	10...30	IP 65 / IP 67	10	100	24	KQ6004
Cable with connector 0.1 m · Output function  · DC PNP · Wiring diagram no. 6 · Connector groups 8, 10, 18, 20, 120, 124, 126, 128, 157									
	20 x 7 x 48	12 nf	PBT	10...30	IP 65 / IP 67	10	100	26	KQ5101
	20 x 14 x 48	12 nf	PBT	10...30	IP 65 / IP 67	10	100	27	KQ6005

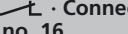
f = flush / nf = non flush

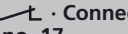
Sensors with ATEX approval

Type	Dimensions [mm]	Sensing range [mm]	Material	U _{nom.} at 1 kΩ [V]	U _b [V]	Internal capacit. [nF]	Internal inductance [μH]	f [Hz]	Drawing no.	Order no.
Cable 2 m · Output function  · Connection to certified intrinsically safe circuits with the max. values U = 15 V / I = 50 mA / P = 120 mW · Wiring diagram no. 16										
	M30 / L = 81	15 nf	PBT	8.2 DC	7.5...15	375	1	40	4	KI5030
Cable 6 m · Output function  · Connection to certified intrinsically safe circuits with the max. values U = 15 V / I = 50 mA / P = 120 mW · Wiring diagram no. 16										
	M30 / L = 81	15 nf	PBT	8.2 DC	7.5...15	375.64	3	40	4	KI5031
Cable 2 m · Output function  · Connection to certified intrinsically safe circuits with the max. values U = 15 V / I = 50 mA / P = 120 mW · Wiring diagram no. 17										
	M34 / L = 92	15 nf	Brass	8.2 DC	7.5...15	375	1	40	28	KX5001

Type	Dimensions [mm]	Sensing range [mm]	Material	U _{nom.} at 1 kΩ [V]	U _b [V]	Internal capacit. [nF]	Internal inductance [μH]	f [Hz]	Draw- ing no.	Order no.
------	--------------------	--------------------------	----------	-------------------------------------	-----------------------	------------------------------	--------------------------------	-----------	---------------------	--------------

Cable 6 m · Output function  · Connection to certified intrinsically safe circuits with the max. values U = 15 V / I = 50 mA / P = 120 mW · Wiring diagram no. 17

	M34 / L = 92	15 nf	Brass	8.2 DC	7.5...15	375.64	3	40	28	KX5002
---	--------------	-------	-------	--------	----------	--------	---	----	----	--------

Cable 20 m · Output function  · Connection to certified intrinsically safe circuits with the max. values U = 15 V / I = 50 mA / P = 120 mW · Wiring diagram no. 17

	M34 / L = 92	15 nf	Brass	8.2 DC	7.5...15	377.88	10	40	28	KX5004
---	--------------	-------	-------	--------	----------	--------	----	----	----	--------

Terminals · Output function  · DC PNP · Wiring diagram no. 18

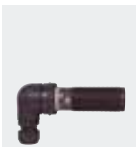
	M30 / L = 150	15 nf	PBT	10...30 DC	–	–	–	10	29	KI503A
	M30 / L = 125	15 nf	PBT	10...30 DC	–	–	–	10	30	KI505A

Terminals · Output function  · AC/DC · Wiring diagram no. 28

	M30 / L = 150	15 nf	PBT	20...250 DC/ 30...250 AC	–	–	–	10	29	KI000A*
	M30 / L = 125	15 nf	PBT	20...250 DC/ 30...250 AC	–	–	–	10	30	KI001A*

Terminals · Output function  · AC/DC · Wiring diagram no. 26

	105 x 80 x 42	60 nf	modified PPE	20...250 AC/DC	–	–	–	4	31	KD001A*
---	---------------	-------	--------------	-------------------	---	---	---	---	----	---------

Terminals · Output function  · DC PNP · Wiring diagram no. 25

	105 x 80 x 42	60 nf	modified PPO	10...36 DC	–	–	–	10	31	KD501A
---	---------------	-------	--------------	------------	---	---	---	----	----	--------

f = flush / nf = non flush

* Note for AC and AC/DC units

Miniature fuse to IEC60127-2 sheet 1, ≤ 2 A (fast acting) Recommendation: check the unit for reliable function after a short circuit.









Switching amplifiers with ATEX approval

Type	U _b [V]	Power / current consumption [VA] / [mA]	f [Hz]	T _a [°C]	Output	Protection	Draw- ing no.	Order no.
	115	1.0 /	10	-20...60	relay (1 changeover contact)	IP 20	32	N0030A

Position sensors

Type	U _b [V]	Power / current consumption [VA] / [mA]	f [Hz]	T _a [°C]	Output	Protection	Draw- ing no.	Order no.
	230	1.0 /	10	-20...60	relay (1 changeover contact)	IP 20	32	N0031A
	115	1.3 /	10	-20...60	relay (1 changeover contact per channel)	IP 20	32	N0032A
	230	1.3 /	10	-20...60	relay (1 changeover contact per channel)	IP 20	32	N0033A
	24	/ < 23	10	-20...60	relay (1 changeover contact)	IP 20	32	N0530A
	24	/ < 50	5000	-20...60	2 transistor outputs PNP (100 mA, short-circuit protection)	IP 20	32	N0531A
	24	/ < 50	5000	-20...60	2 outputs (optocoupler, bipolar, 100 mA, short-circuit protection)	IP 20	32	N0532A
	24	/ < 50	10	-20...60	relay (1 changeover contact per channel)	IP 20	32	N0533A
	24	/ < 50	5000	-20...60	2 transistor outputs PNP (100 mA, short-circuit protection)	IP 20	32	N0534A

Dynamic capacitive touch sensors

Type	U _b [V]	I _{load} [mA]	Current consumption [mA]	Ambient temperature [°C]	Protection	Draw- ing no.	Order no.
Cable 2 m · Output function  · DC PNP							
	24	200	30	-40...85	IP 67 / IP 69K	33	KT5010
Cable with connector 0.3 m · Output function  · DC PNP · Connector groups 4, 5, 74, 80, 124							
	24	200	30	-40...85	IP 67 / IP 69K	33	KT5011
Cable 2 m · Output function  · DC PNP							
	24	200	30	-40...85	IP 65 / IP 67 / IP 69K	34	KT5309
Cable with connector 0.3 m · Output function  · DC PNP · Connector groups 8, 10, 11, 18, 20, 120, 124, 126, 128, 130, 157, 158							
	24	200	30	-40...85	IP 65 / IP 67 / IP 69K	35	KT5102

Type	U_b [V]	I_{load} [mA]	Current consumption [mA]	Ambient temperature [°C]	Protection	Draw- ing no.	Order no.
------	--------------	--------------------	--------------------------------	--------------------------------	------------	---------------------	--------------

Cable 2 m · Output function  · DC PNP



24	200	30	-40...85	IP 65 / IP 67 / IP 69K	35	KT5111
----	-----	----	----------	------------------------	----	--------

Cable with connector 0.3 m · Output function  · DC PNP · Connector groups 8, 10, 11, 18, 20, 120, 124, 126, 128, 130, 157, 158



24	200	30	-40...85	IP 65 / IP 67 / IP 69K	35	KT5112
----	-----	----	----------	------------------------	----	--------

Static capacitive touch sensors

Type	U_b [V]	I_{load} [mA]	Current consumption [mA]	Ambient temperature [°C]	Protection	Draw- ing no.	Order no.
------	--------------	--------------------	--------------------------------	--------------------------------	------------	---------------------	--------------

Cable 2 m · Output function  · DC PNP



24	200	30	-40...85	IP 67 / IP 69K	33	KT5012
----	-----	----	----------	----------------	----	--------

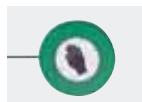

24	200	30	-40...85	IP 65 / IP 67 / IP 69K	33	KT5050
----	-----	----	----------	------------------------	----	--------

Cable with connector 0.3 m · Output function  · DC PNP · Connector groups 4, 5, 74, 80, 124

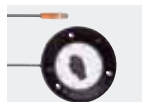

24	200	30	-40...85	IP 67 / IP 69K	33	KT5013
----	-----	----	----------	----------------	----	--------

Cable with connector 0.3 m · Output function  · DC PNP · Connector groups 8, 10, 11, 18, 20, 120, 124, 126, 128, 130, 157, 158



24	200	30	-40...85	IP 65 / IP 67 / IP 69K	35	KT5106
----	-----	----	----------	------------------------	----	--------

Cable 2 m · Output function  · DC PNP



24	200	30	-40...85	IP 65 / IP 67 / IP 69K	35	KT5110
----	-----	----	----------	------------------------	----	--------

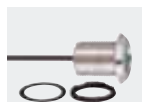

24	200	30	-40...85	IP 65 / IP 67 / IP 69K	34	KT5310
----	-----	----	----------	------------------------	----	--------

Capacitive touch sensors with latching evaluation principle

Type	U _b [V]	I _{load} [mA]	Current consumption [mA]	Ambient temperature [°C]	Protection	Drawing no.	Order no.
------	-----------------------	---------------------------	-----------------------------	-----------------------------	------------	-------------	-----------

Cable 2 m · Output function  · DC PNP

	24	200	30	-40...85	IP 65 / IP 67 / IP 69K	35	KT5150
---	----	-----	----	----------	------------------------	----	--------

Cable 0.3 m · Output function  · DC PNP · Connector groups 8, 10, 11, 18, 20, 120, 124, 126, 128, 130, 157, 158

	24	200	30	-40...85	IP 65 / IP 67 / IP 69K	35	KT5151
---	----	-----	----	----------	------------------------	----	--------







Cable 2 m · Output function  · DC PNP

	24	200	30	-40...85	IP 65 / IP 67 / IP 69K	34	KT5350
---	----	-----	----	----------	------------------------	----	--------

Cable 0.3 m · Output function  · DC PNP · Connector groups 8, 10, 11, 18, 20, 120, 124, 126, 128, 130, 157, 158

	24	200	30	-40...85	IP 65 / IP 67 / IP 69K	34	KT5351
---	----	-----	----	----------	------------------------	----	--------

Accessories

Type	Description	Order no.
	LINERECORDER SENSOR · Version 4.0.0 · Software for clear online and offline parameter setting of IO-Link sensors via USB adapter · Use via USB connection cable (drivers are supplied): E30396 IO-Link interface or E30390 IO-Link master (note the respective data sheet) · IODD import and update from ifm's homepage · Reading of IODDs via storage media · Automatic sensor identification · Graphic representation of the process values and history incl. export function · Documentation and archiving · Transferable parameter sets · Full memory plug support for IO-Link 1.1	QA0001
	IO-Link interface · for parameter setting and analysis of units with max. 65 mA current consumption · Supported communication protocols: IO-Link (4800 and 38400 bits/s) EPS protocol (19200 bits/s) · for operation with FDT framework software "ifm Container" or software "LINERECORDER SENSOR"	E30396
	Memory plug · Parameter memory for IO-Link sensors · Storage capacity: 2 Kbytes · Housing materials: PA PACM 12 / PET / sealing: FPM / nut: stainless steel 316L / 1.4404 / connector: TPU	E30398
	Cover ring 100 mm · for type KT50 · Housing materials: polycarbonate-ABS yellow	E80372
	Cover ring 100 mm · for type KT50 · Housing materials: polycarbonate-ABS green	E80373
	Cover ring 100 mm · for type KT50 · Housing materials: polycarbonate-ABS Red	E80374
	Cover ring 100 mm · for type KT50 · Housing materials: polycarbonate-ABS blue	E80375

Type	Description	Order no.
	Cover ring 100 mm · for type KT50 · Housing materials: polycarbonate-ABS orange	E80376
	Symbol disc (plastic) · Ø 20.4 mm · for type KT51 / KT53 · Start symbol · Housing materials: Polyamide	E12377
	Symbol disc (plastic) · Ø 20.4 mm · for type KT51 / KT53 · Symbol Stop · Housing materials: Polyamide	E12378
	Symbol disc (plastic) · Ø 20.4 mm · for type KT51 / KT53 · Symbol ON · Housing materials: Polyamide	E12379
	Symbol disc (plastic) · Ø 20.4 mm · for type KT51 / KT53 · Symbol OFF · Housing materials: Polyamide	E12380
	Symbol disc (plastic) · Ø 20.4 mm · for type KT51 / KT53 · Without symbol, transparent · Housing materials: Polyamide	E12386









Accessories mounting adapters

Type	Description	Order no.
	Mounting adapter · M18 x 1 - G $\frac{3}{4}$ · Housing materials: POM	E43900
	Mounting adapter · M18 x 1 - G 1 · Housing materials: POM	E43904
	Mounting adapter · M30 x 1.5 - G $1\frac{1}{4}$ · Housing materials: PVDF / EPDM	E11036
	Mounting adapter · M30 x 1.5 - G $1\frac{1}{2}$ · Housing materials: PVDF / EPDM	E11034
	Mounting adapter · Ø 34 mm - G $1\frac{1}{2}$ · Housing materials: POM	E11027
	Locknut · G $\frac{3}{4}$ · for mounting adapter · Housing materials: POM	E43902
	Locknut · G $1\frac{1}{4}$ · for mounting adapter · Housing materials: PVDF	E11030
	Locknut · G $1\frac{1}{2}$ · for mounting adapter · Housing materials: PVDF	E11032

Position sensors

Type	Description	Order no.
	Protective cover · G 1¼ · for mounting adapter · Housing materials: PES black transparent	E11078

Accessories mounting components

Type	Description	Order no.
	Mounting clamp · Ø 20 mm · Ø 18 mm · with reducing bush · for type M18 · Housing materials: PBT	E10076
	Mounting clamp · Ø 34 mm · Ø 30 mm · with reducing bush · for type M30 · Housing materials: PBT	E10077
	Angle bracket · for type M12 · Housing materials: stainless steel	E10735
	Angle bracket · for type M18 · Housing materials: stainless steel	E10736
	Angle bracket · for type M30 · Housing materials: stainless steel	E10737
	Mounting adapter for free-standing mounting · for type KQ5, KQ6 · Housing materials: adapter: PBT / inserts: Brass / screw: steel galvanised	E12153
	Mounting adapter · Pipe and tube installation KQ5 / KQ6 with cable ties · Fixing of the types KQ5 and KQ6 to pipes and tubes · Housing materials: Mounting adapter: PA 12 black	E12163
	Fixing strap · Length: 760 mm · for capacitive level sensors · for type KNQ, KQ5, KQ6 · Housing materials: PA	E10880
	Mounting set · M30 x 1.5 / G ¼...G 1 · for capacitive sensors on rising pipes G ¼" - 1" · Housing materials: POM	E11037

Wiring diagrams

Core colours

BN	brown
BU	blue
BK	black
WH	white
GN/YE	green/yellow

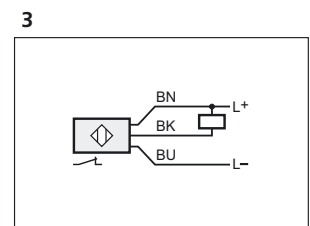
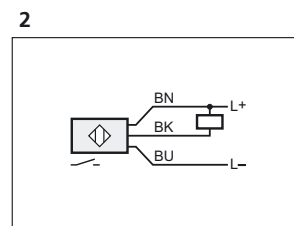
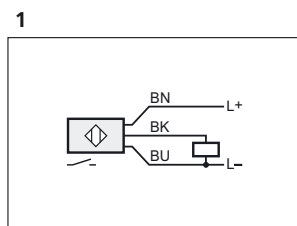

Wiring diagrams

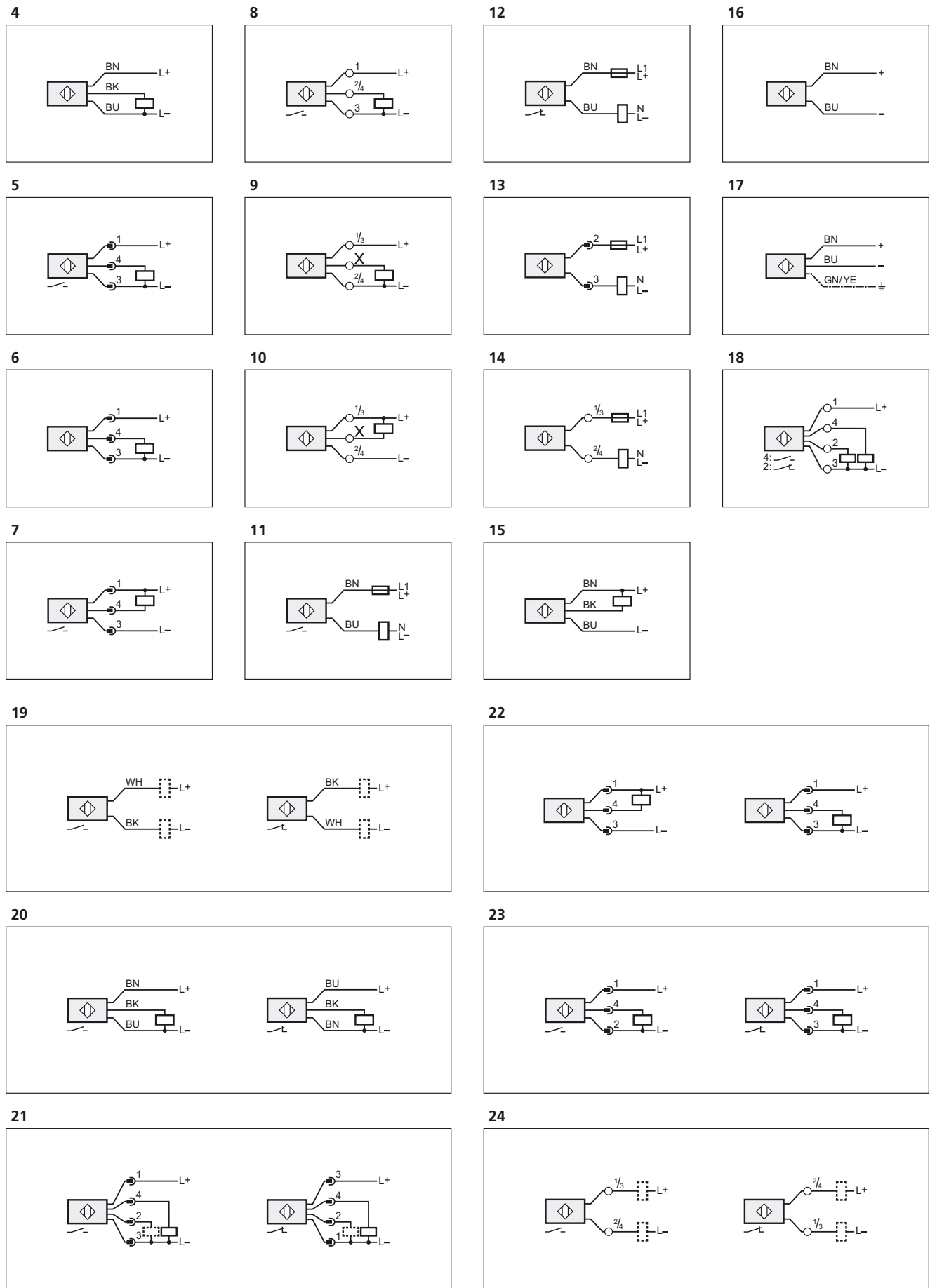

2: function check output / programming wire

Wiring diagrams

25

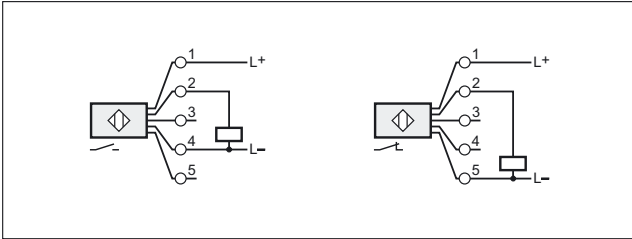

27

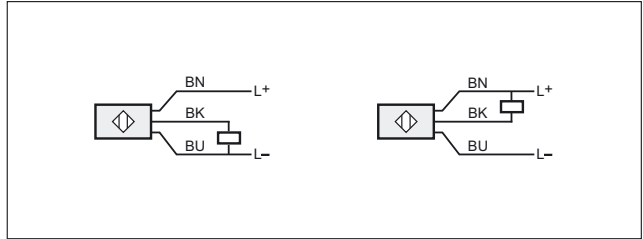

26

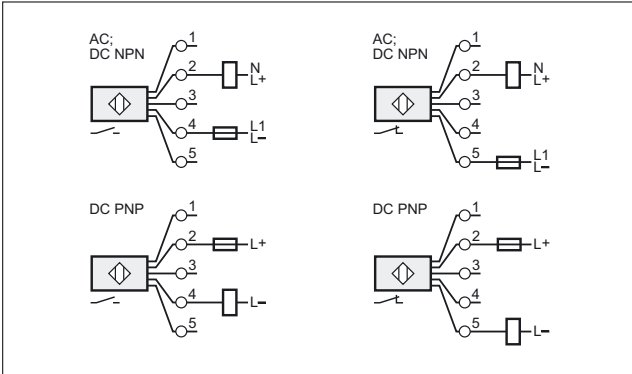

28

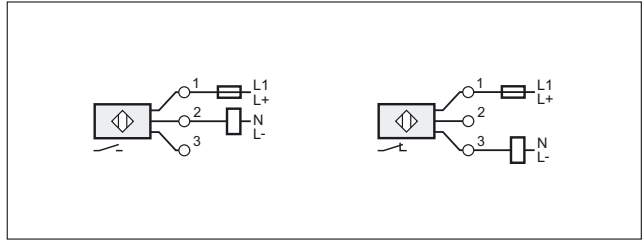

Scale drawings / drawing no. – CAD download: www.ifm.com

1

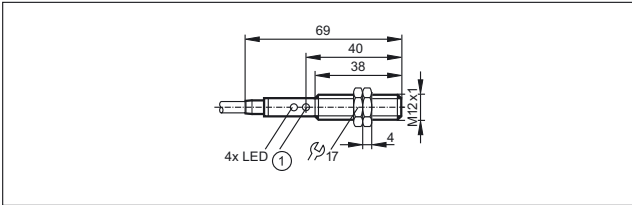

2

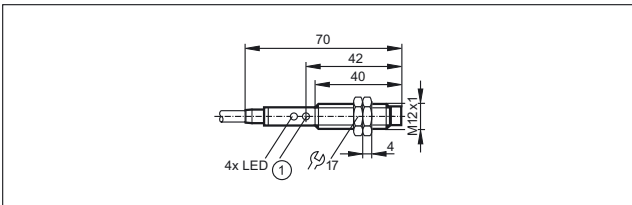

3

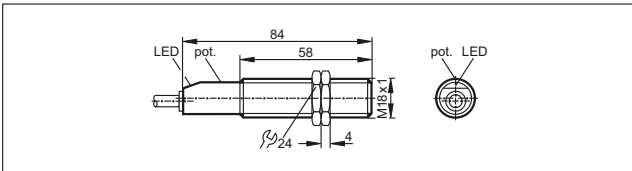

4

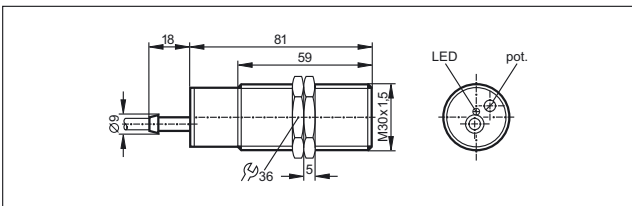

5

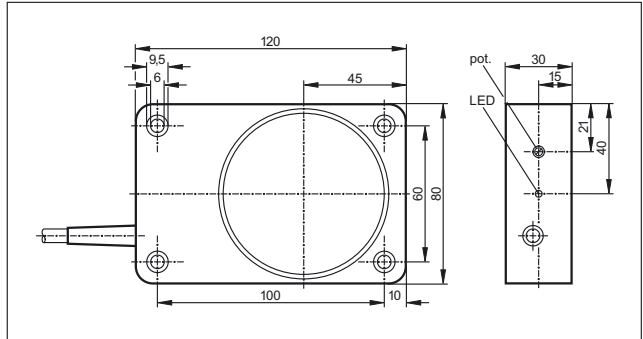

6

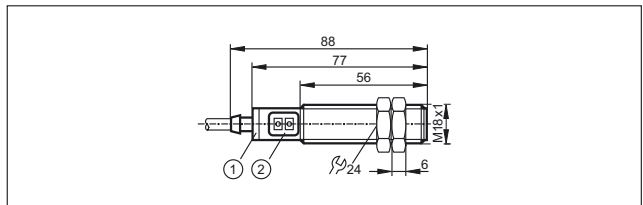

1: LED ring, 2: Programming buttons

Scale drawings / drawing no. – CAD download: www.ifm.com

7

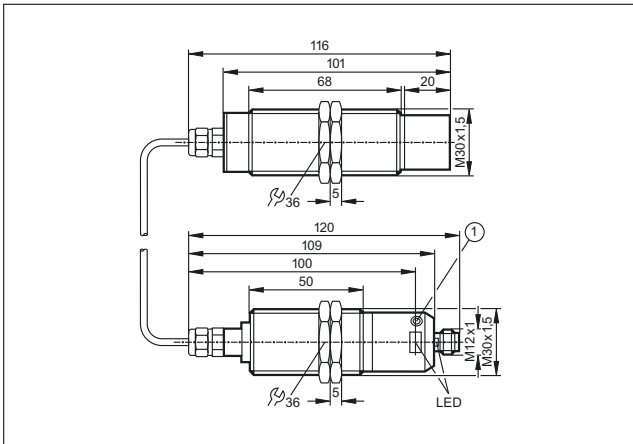

1: Programming button

8

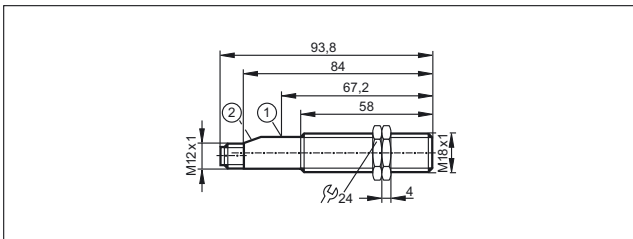

1: potentiometer, 2: LED

9

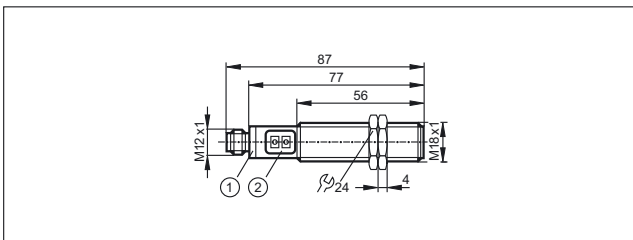

1: LED ring, 2: Programming buttons

10

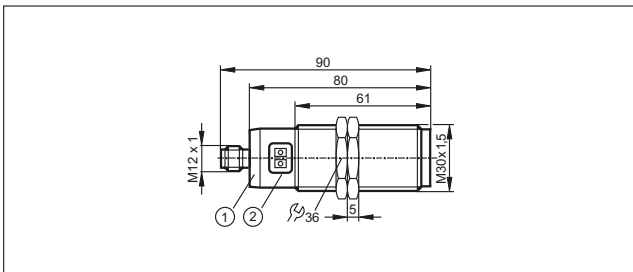

1: LED ring, 2: Programming buttons

11

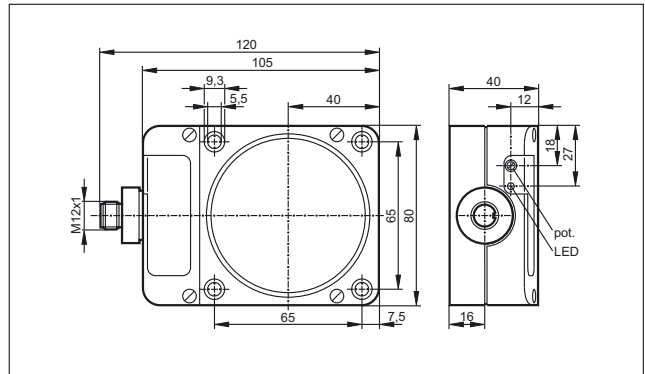

12

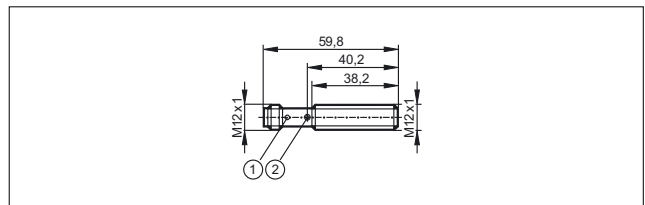

1: LED 4 x 90°, 2: potentiometer

13

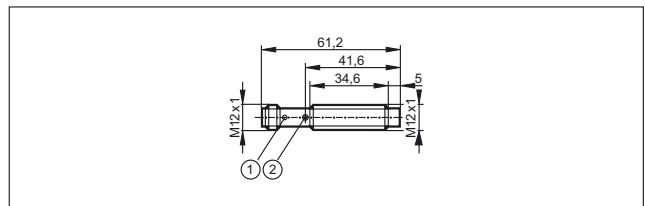

1: LED 4 x 90°, 2: potentiometer

14

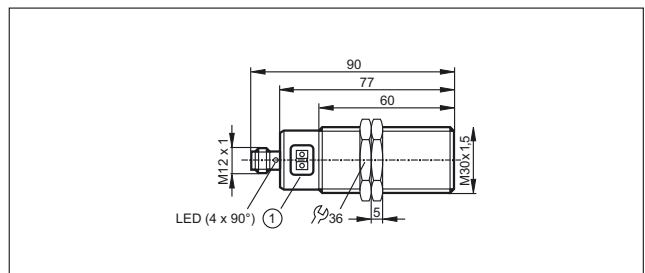

1: Programming buttons

15

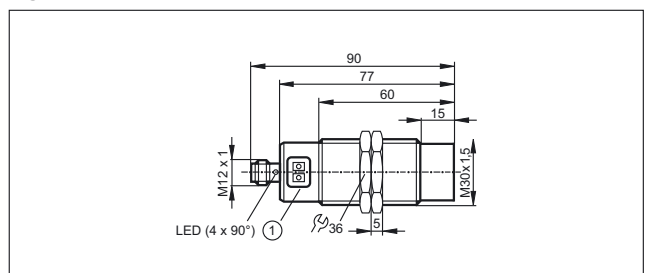

1: Programming buttons

Scale drawings / drawing no. – CAD download: www.ifm.com

16

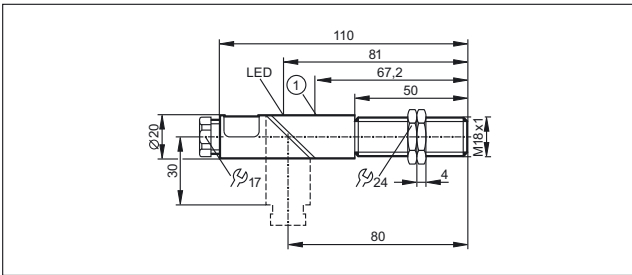

1: potentiometer

17

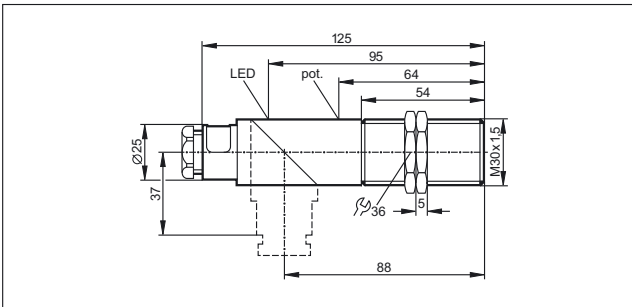

21

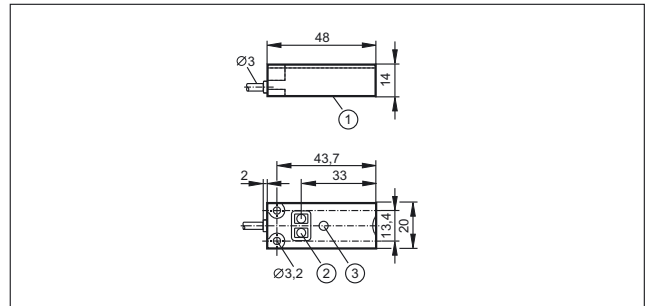

1: sensing face, 2: Programming buttons, 3: LED

22

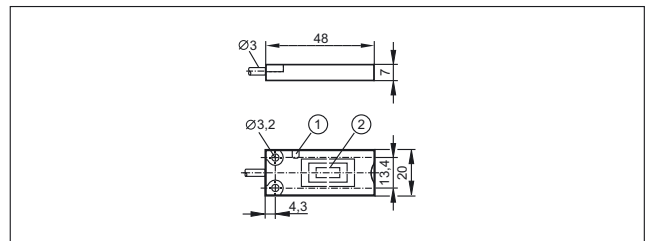

1: LED, 2: sensing face

18

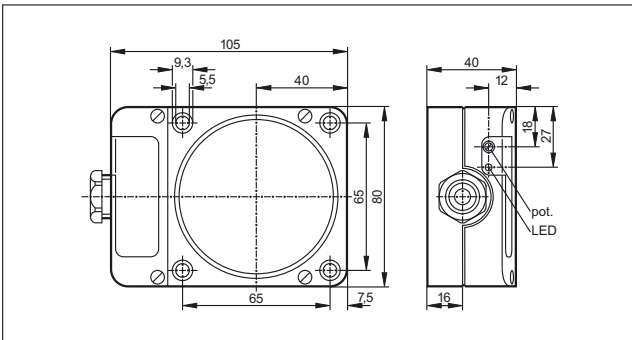

23

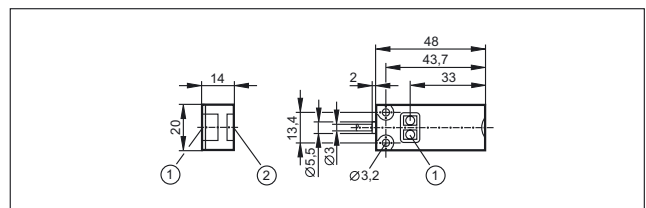

1: Programming buttons, 2: sensing face

19

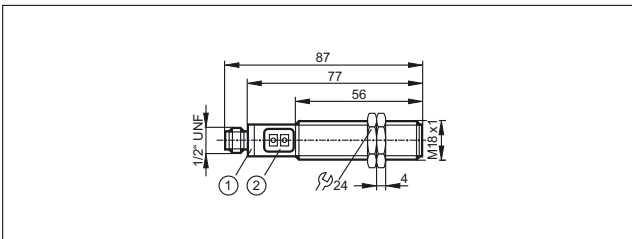

24

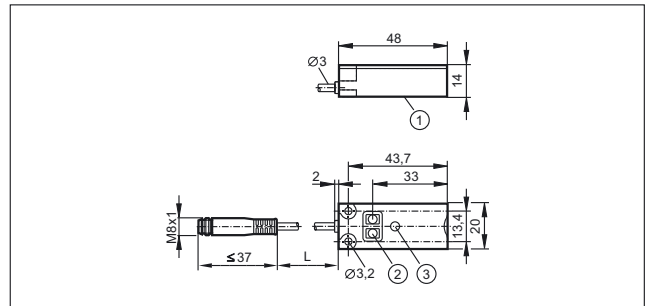

1: sensing face, 2: Programming buttons, 3: LED

20

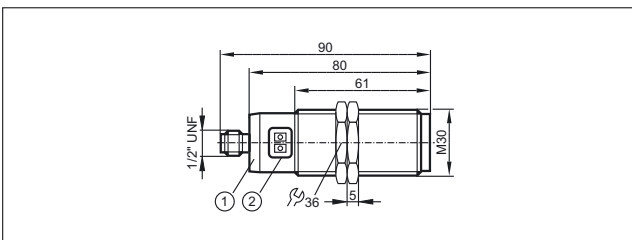

1: LED ring, 2: Programming buttons

25

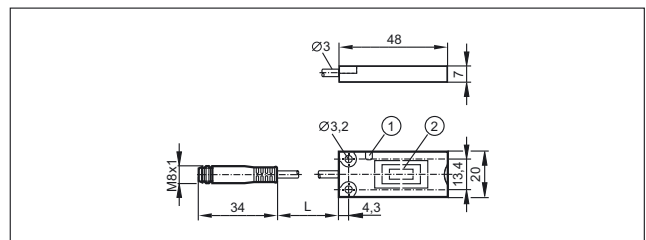

1: LED, 2: sensing face

Scale drawings / drawing no. – CAD download: www.ifm.com

26

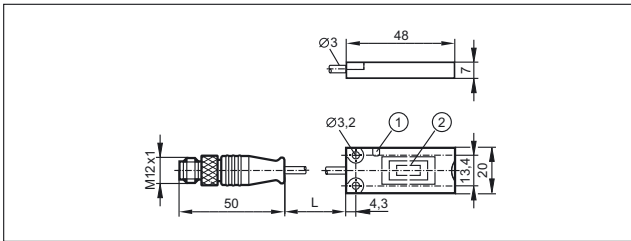

1: LED, 2: sensing face

27

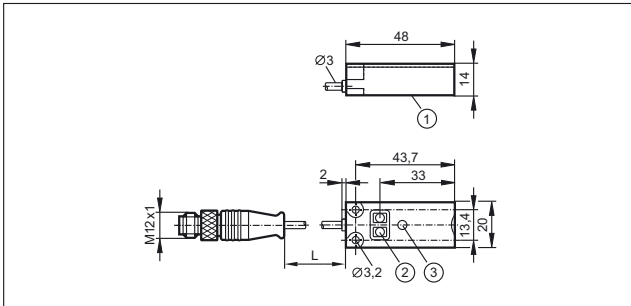

1: sensing face, 2: Programming buttons, 3: LED

28

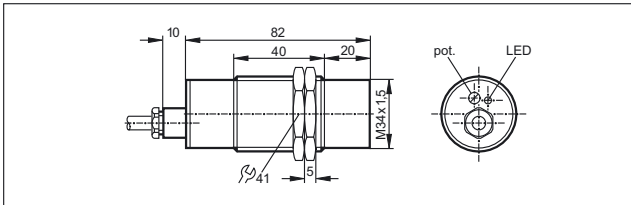

29

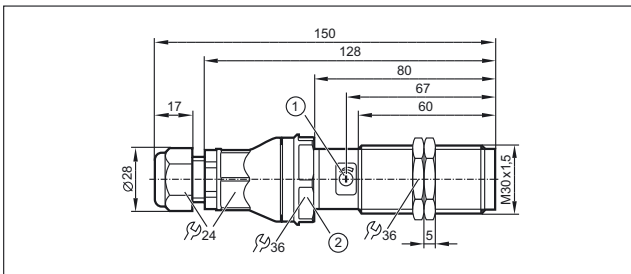

1: potentiometer, 2: tightening torque 10 Nm

30

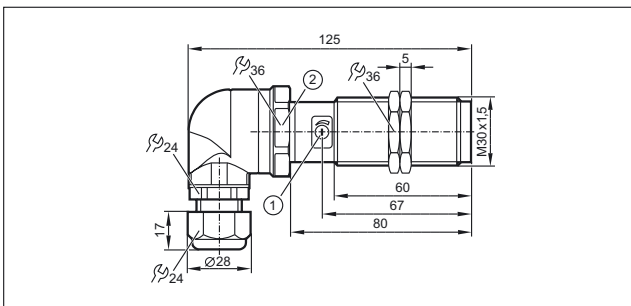

1: potentiometer, 2: tightening torque 10 Nm

31

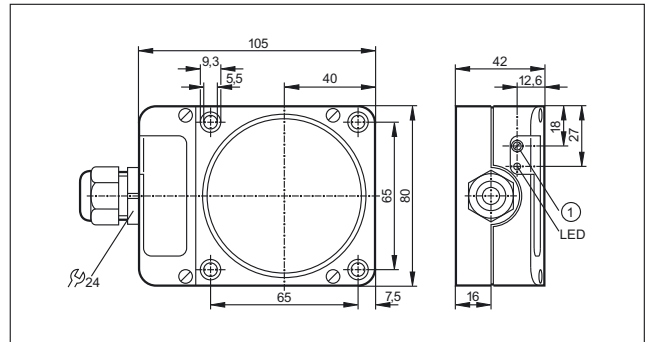

1: potentiometer

32

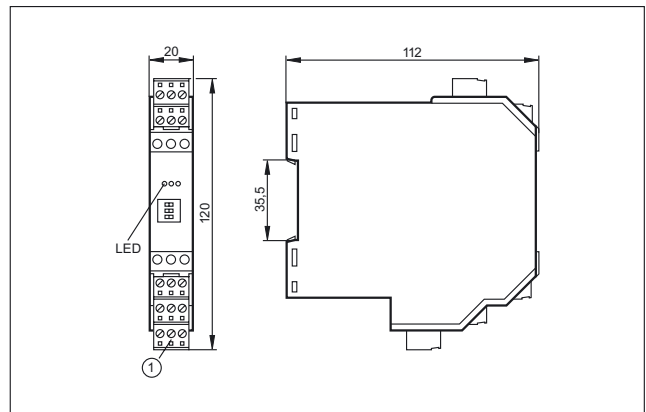

1: Combicon plug with screw terminals (optional)

33

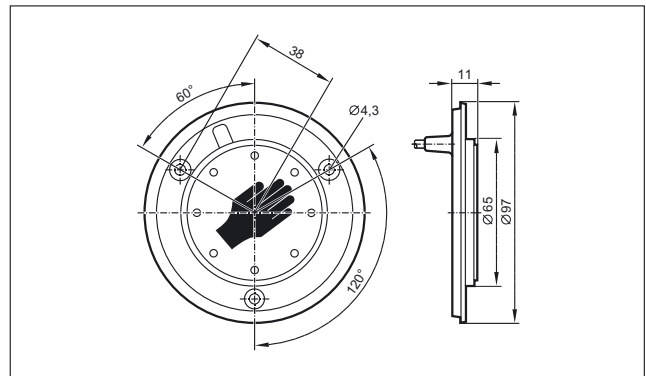

34

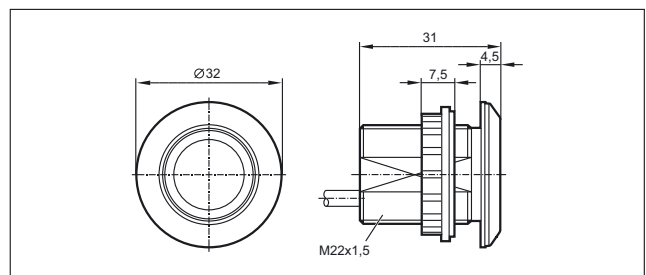

Scale drawings / drawing no. – CAD download: www.ifm.com

35

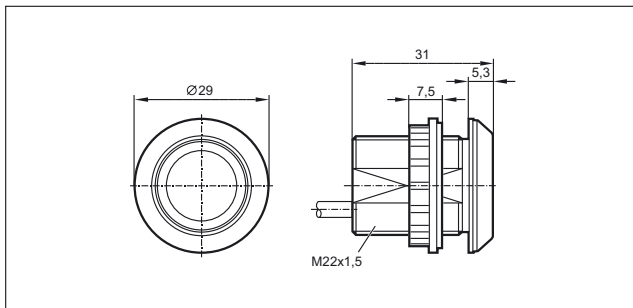





- **Magnetic sensors for long sensing ranges**
- **Small designs with sensing ranges up to 100 mm**
- **Detection through non-ferrous metals**
- **Cylindrical and rectangular designs for demanding applications**
- **Tough all-steel housings and temperature range for universal use**

Magnetic sensors

Magnetic sensors come into their own where inductive sensors reach their limits. Compared to inductive sensors magnetic sensors have a considerably higher sensing range for the comparable housing sizes, yet can be used in environments where other long range detection techniques are simply not suitable.

Magnetic sensors are used for reliable and highly repeatable position detection in similar applications to inductive sensors, but are also very effective in more complex applications since magnetic fields penetrate all non-magnetisable materials. So the sensors can detect magnets through walls made of non-ferrous metal (stainless steel, aluminium), plastic or wood. This allows a sensor to be fitted outside, for example, a sensitive hygienic area.

In the food industry the magnetic sensor is often used in pigging systems. By means of magnetic sensors the exact position of the pig can be detected from the outside through the wall of the stainless steel pipe.

Operating principle

Magnetic sensors from ifm use state-of-the-art GMR (Giant Magneto Resistive Effect) technology as used in computer hard drives. The measuring cell consists of resistors with several extremely fine, ferromagnetic and non-magnetic layers. Whereas in a conventional Wheatstone bridge circuit two screened and two unscreened GMR resistors are combined, a large signal proportional to the magnetic field is produced if a magnetic field is present. As from a defined threshold value an output signal is switched via a comparator. The strength of the magnet determines the sensing range.

Installation

Magnetic sensors can be mounted flush with all materials (even metals) without reduction in the sensing range. Depending on the orientation of the magnetic field the sensor can be damped from the front or from the side.

Hydraulic sensors - operating principle

The new operating principle is based on a magnetic-inductive technology that detects only ferromagnetic metals (e.g. tool steel). The sensor is flush-mountable. The sensor detects the steel target and switches at the same range reliably even if installed in a recess.

Besides use as a limit switch in hydraulic cylinders, the sensor can also be used on other hydraulic components such as valves or pumps.

The new MFH and M9H series sensors offer an impressive performance at an attractive price.













The sensor switches as soon as the magnet has reached the switch-on point. The direction of movement of the magnet is not important.

High-pressure resistant sensors for hydraulic cylinders and valves.



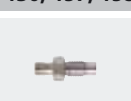

System overview	Page
Full-metal sensors for high-pressure resistant applications on hydraulic cylinders and valves	172
Full metal sensors for industrial applications	172 - 173
Sensors for industrial applications	173 - 174
Full metal sensors for hygienic and wet areas	174 - 175
Sensors for hygienic and wet areas	175
Accessories damping magnets	175 - 176
Accessories mounting components	176
Accessories mounting sets	176 - 177
Wiring diagrams	177
Scale drawings / drawing no. – CAD download: www.ifm.com	177 - 178

Full-metal sensors for high-pressure resistant applications on hydraulic cylinders and valves

Type	Dimensions [mm]	Sensing range [mm]	Material	U _b [V]	Protection	f [Hz]	I _{load} [mA]	Drawing no.	Order no.
M12 connector · Output function  · DC PNP · Wiring diagram no. 1 · Connector groups 8, 10, 11, 18, 20, 120, 124, 126, 128, 130, 157, 158									
	M12 / L = 93	1.8 f	High-grade st. steel	10...36	IP 65 / IP 68 / IP 69K	1000	200	1	MFH200
M12 connector · Output function  · DC NPN · Wiring diagram no. 2 · Connector groups 8, 10, 18, 20, 120, 124, 126, 128, 157									
	M12 / L = 93	1.8 f	High-grade st. steel	10...36	IP 65 / IP 68 / IP 69K	1000	200	1	MFH201
M12 connector · Output function  · DC PNP · Wiring diagram no. 1 · Connector groups 8, 10, 11, 18, 20, 120, 124, 126, 128, 130, 157, 158									
	M12 / L = 60	1.8 f	High-grade st. steel	10...36	IP 65 / IP 68 / IP 69K	1000	200	2	MFH202
M12 connector · Output function  · DC NPN · Wiring diagram no. 2 · Connector groups 8, 10, 18, 20, 120, 124, 126, 128, 157									
	M12 / L = 60	1.8 f	High-grade st. steel	10...36	IP 65 / IP 68 / IP 69K	1000	200	2	MFH203
M12 connector · Output function  · DC PNP · Wiring diagram no. 3 · Connector groups 8, 10, 18, 20, 120, 124, 126, 128, 157									
	M12 / L = 60	1.8 f	High-grade st. steel	10...36	IP 65 / IP 68 / IP 69K	1000	200	2	MFH204
M12 connector · Output function  · DC PNP · Wiring diagram no. 1 · Connector groups 8, 10, 11, 18, 20, 120, 124, 126, 128, 130, 157, 158									
	special design	2 f	High-grade st. steel	10...36	IP 65 / IP 68 / IP 69K	1000	200	3	M9H200

f = flush / nf = non flush

Full metal sensors for industrial applications

Type	Dimensions [mm]	Sensing range [mm]	Material	U _b [V]	Protection	f [Hz]	I _{load} [mA]	Drawing no.	Order no.
M12 connector · Output function  · DC PNP · Wiring diagram no. 1 · Connector groups 120, 124, 126, 128, 130, 157, 158									
	M12 / L = 60	60	High-grade st. steel	10...30	IP 65 / IP 67	5000	200	4	MFS211
	M18 / L = 60	70	High-grade st. steel	10...30	IP 65 / IP 67	5000	200	5	MGS204

Type	Dimensions [mm]	Sensing range [mm]	Material	U _b [V]	Protection	f [Hz]	I _{load} [mA]	Draw- ing no.	Order no.
------	--------------------	--------------------------	----------	-----------------------	------------	-----------	---------------------------	---------------------	--------------

M12 connector · Output function  · DC NPN · Wiring diagram no. 2 · Connector groups 120, 124, 126, 128, 157

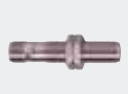
	M12 / L = 60	60	High-grade st. steel	10...30	IP 65 / IP 67	5000	200	4	MFS209
---	--------------	----	----------------------	---------	---------------	------	-----	---	--------

M12 connector · Output function  · DC PNP · Wiring diagram no. 3 · Connector groups 120, 124, 126, 128, 157

	M12 / L = 60	60	High-grade st. steel	10...30	IP 65 / IP 67	5000	200	4	MFS210
---	--------------	----	----------------------	---------	---------------	------	-----	---	--------

	M18 / L = 60	70	High-grade st. steel	10...30	IP 65 / IP 67	5000	200	5	MGS206
---	--------------	----	----------------------	---------	---------------	------	-----	---	--------

M12 connector · Output function  · DC NPN · Wiring diagram no. 2 · Connector groups 120, 124, 126, 128, 157

	M18 / L = 60	70	High-grade st. steel	10...30	IP 65 / IP 67	5000	200	5	MGS205
---	--------------	----	----------------------	---------	---------------	------	-----	---	--------

Sensors for industrial applications

Type	Dimensions [mm]	Sensing range [mm]	Material	U _b [V]	Protection	f [Hz]	I _{load} [mA]	Draw- ing no.	Order no.
------	--------------------	--------------------------	----------	-----------------------	------------	-----------	---------------------------	---------------------	--------------

Cable 2 m · Output function  · DC PNP · Wiring diagram no. 4

	M8 / L = 50	60	stainless steel (316L)	10...30	IP 67	5000	200	6	ME5011
---	-------------	----	------------------------	---------	-------	------	-----	---	--------

	M12 / L = 50	60	High-grade st. steel	10...30	IP 67	5000	200	7	MFS201
---	--------------	----	----------------------	---------	-------	------	-----	---	--------

	M18 / L = 50	70	stainless steel	10...30	IP 67	5000	200	8	MGS201
---	--------------	----	-----------------	---------	-------	------	-----	---	--------

Cable 2 m · Output function  · DC NPN · Wiring diagram no. 5

	M8 / L = 40	60	stainless steel (316L)	10...30	IP 67	5000	200	9	ME5015
---	-------------	----	------------------------	---------	-------	------	-----	---	--------

	M12 / L = 50	60	High-grade st. steel	10...30	IP 67	5000	200	7	MFS202
---	--------------	----	----------------------	---------	-------	------	-----	---	--------

Cable 2 m · Output function  · DC PNP · Wiring diagram no. 6

	M18 / L = 50	70	stainless steel	10...30	IP 67	5000	200	8	MGS202
---	--------------	----	-----------------	---------	-------	------	-----	---	--------

Position sensors

Type	Dimensions [mm]	Sensing range [mm]	Material	U _b [V]	Protection	f [Hz]	I _{load} [mA]	Drawing no.	Order no.
------	--------------------	-----------------------	----------	-----------------------	------------	-----------	---------------------------	-------------	-----------

M8 connector · Output function  · DC PNP · Wiring diagram no. 1 · Connector groups 1, 2, 3, 72, 78, 120, 122

	M8 / L = 60	60	stainless steel (316L)	10...30	IP 67	5000	200	10	ME5010
---	-------------	----	------------------------	---------	-------	------	-----	----	--------

M12 connector · Output function  · DC NPN · Wiring diagram no. 2 · Connector groups 8, 10, 18, 20, 120, 124, 126, 128, 157

	M12 / L = 60	60	High-grade st. steel	10...30	IP 67	5000	200	4	MFS203
---	--------------	----	----------------------	---------	-------	------	-----	---	--------

M12 connector · Output function  · DC PNP · Wiring diagram no. 1 · Connector groups 8, 10, 11, 18, 20, 120, 124, 126, 128, 130, 157, 158

	M12 / L = 60	60	stainless steel	10...30	IP 67	5000	200	4	MF5004
	M12 / L = 60	60	High-grade st. steel	10...30	IP 67	5000	200	4	MFS200
	M18 / L = 60	70	stainless steel	10...30	IP 67	5000	200	5	MGS200

Cable 2 m · Output function  · DC PNP · Wiring diagram no. 4

	28 x 10 x 16	60	PBT	10...30	IP 67	5000	200	11	MS5011
---	--------------	----	-----	---------	-------	------	-----	----	--------

Cable with connector 0.15 m · Output function  · DC PNP · Wiring diagram no. 1 · Connector groups 1, 2, 3, 72, 78, 120, 122

	40 x 12 x 26	60	PBT	10...30	IP 67	–	200	12	MN5200
---	--------------	----	-----	---------	-------	---	-----	----	--------

M8 connector · Output function  · DC PNP · Wiring diagram no. 7 · Connector groups 1, 2, 3, 72, 78, 120, 122

	28 x 10 x 16	60	PBT	10...30	IP 67	5000	200	13	MS5013
---	--------------	----	-----	---------	-------	------	-----	----	--------

M8 connector · Output function  · DC PNP · Wiring diagram no. 1 · Connector groups 1, 2, 3, 72, 78, 120, 122



	28 x 10 x 16	60	PBT	10...30	IP 67	5000	200	13	MS5010
---	--------------	----	-----	---------	-------	------	-----	----	--------

Full metal sensors for hygienic and wet areas







Type	Dimensions [mm]	Sensing range [mm]	Material	U _b [V]	Protection	f [Hz]	I _{load} [mA]	Drawing no.	Order no.
------	--------------------	-----------------------	----------	-----------------------	------------	-----------	---------------------------	-------------	-----------

M12 connector · Output function  · DC PNP · Wiring diagram no. 1 · Connector groups 120, 124, 126, 128, 130, 157, 158

	M12 / L = 60	60	High-grade st. steel	10...30	IP 65 / IP 68 / IP 69K	5000	100	4	MFT202
---	--------------	----	----------------------	---------	---------------------------	------	-----	---	--------

Type	Dimensions [mm]	Sensing range [mm]	Material	U _b [V]	Protection	f [Hz]	I _{load} [mA]	Draw- ing no.	Order no.
M12 connector · Output function  · DC PNP · Wiring diagram no. 1 · Connector groups 120, 124, 126, 128, 130, 157, 158									
	Ø 12 / L = 60	60	High-grade st. steel	10...30	IP 65 / IP 68 / IP 69K	5000	100	14	MFT204
	M18 / L = 60	70	High-grade st. steel	10...30	IP 65 / IP 68 / IP 69K	5000	100	5	MGT203

Sensors for hygienic and wet areas

Type	Dimensions [mm]	Sensing range [mm]	Material	U _b [V]	Protection	f [Hz]	I _{load} [mA]	Draw- ing no.	Order no.
M12 connector · Output function  · DC PNP · Wiring diagram no. 1 · Connector groups 120, 124, 126, 128, 130, 157, 158									
	M12 / L = 60	60	High-grade st. steel	10...30	IP 68 / IP 69K	5000	200	4	MFT200
M12 connector · Output function  · DC PNP · Wiring diagram no. 1 · Connector groups 8, 10, 11, 18, 20, 120, 124, 126, 128, 130, 157, 158									
	M18 / L = 60	70	High-grade st. steel	10...30	IP 68 / IP 69K	5000	200	5	MGT200
M12 connector · Output function  · DC PNP · Wiring diagram no. 1 · Connector groups 120, 124, 126, 130									
	M18 / L = 60	100	High-grade st. steel	10...30	IP 68 / IP 69K	–	200	5	MGT201

Accessories damping magnets

Type	Description	Order no.
	Damping magnet · M 1.0 · Housing materials: Samarium cobalt	E10749
	Damping magnet · M 2.0 · Housing materials: AlNiCo	E10750
	Damping magnet · M 3.0 · Housing materials: Barium ferrite	E10751
	Damping magnet · M 3.1 · Housing materials: Barium ferrite / stainless steel	E12291
	Damping magnet · M 4.0 · Housing materials: Barium ferrite	E10752



Position sensors



Type	Description	Order no.
	Damping magnet · M 4.1 · Housing materials: Barium ferrite / stainless steel	E11803
	Damping magnet · M 5.0 · Housing materials: Barium ferrite	E10753
	Damping magnet · M 5.1 · Housing materials: Barium ferrite with plastic coating / steel	E10754

Accessories mounting components

Type	Description	Order no.
	Angle bracket · for type M8 · Housing materials: stainless steel	E10734
	Angle bracket · for type M12 · Housing materials: stainless steel	E10735
	Angle bracket · for type M18 · Housing materials: stainless steel	E10736
	Mounting clamp · Ø 8 mm · Housing materials: aluminium black anodised	E10221
	Mounting clamp · Ø 12 mm · with end stop · for type M12 · Housing materials: PC	E11047
	Mounting clamp · Ø 18 mm · with end stop · for type M18 · Housing materials: PC	E11048

Accessories mounting sets

Type	Description	Order no.
	Mounting set · Ø 18.5 mm · Clamp mounting · Free-standing M10 · for type OG, IG, KG · Housing materials: clamp: diecast zinc / fixture: steel	E20718
	Mounting set · Ø 18.5 mm · Clamp mounting · Free-standing M10 · for type OG, IG, KG · Housing materials: clamp: diecast zinc / fixture: steel	E20719
	Mounting set · Ø 18.5 mm · Clamp mounting · Free-standing M10 · for type OG, IG, KG · Housing materials: fixture: stainless steel 316Ti / 1.4571 / clamp: stainless steel	E20869

Type	Description	Order no.
	Mounting set · Ø 18.5 mm · Clamp mounting · Free-standing M10 · for type OG, IG, KG · Housing materials: fixture: stainless steel 316Ti / 1.4571 / clamp: stainless steel	E20870
	Mounting set · Ø 18.5 mm · Clamp mounting · aluminium profile · for type OG, IG, KG · Housing materials: fixture: stainless steel 316Ti / 1.4571 / clamp: diecast zinc / Cube: diecast zinc	E20866
	Mounting set · Ø 18.5 mm · Clamp mounting · aluminium profile · for type OG, IG, KG · Housing materials: fixture: stainless steel 316Ti / 1.4571 / clamp: diecast zinc / Cube: diecast zinc	E20867

Wiring diagrams

Core colours

- BK black
- BN brown
- BU blue

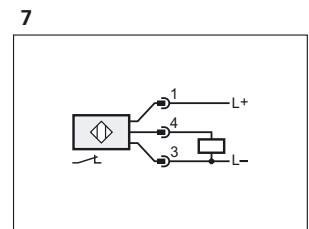
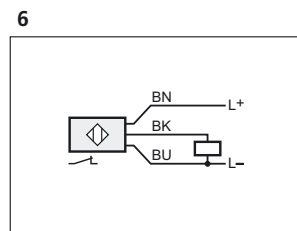
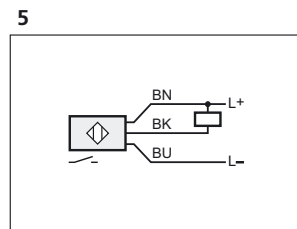
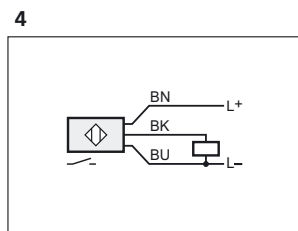
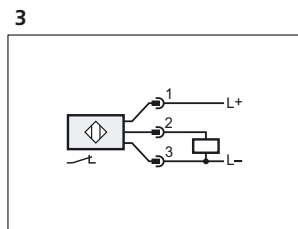
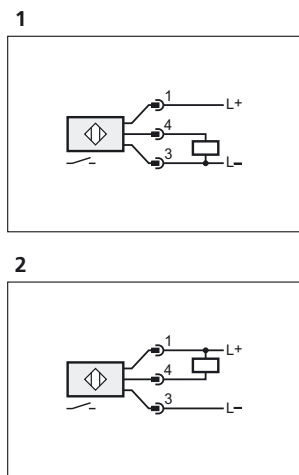

Scale drawings / drawing no. – CAD download: www.ifm.com

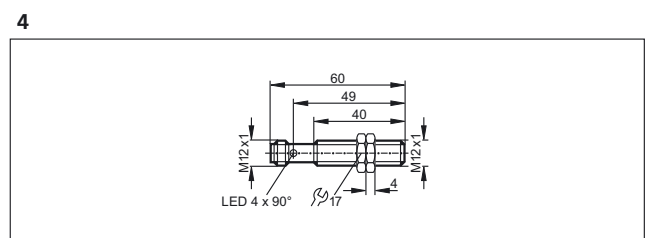
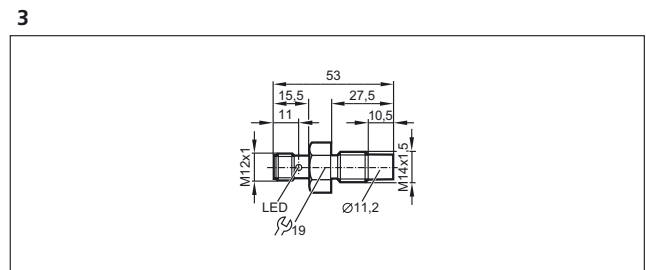
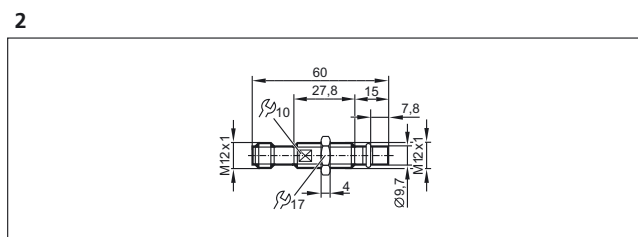
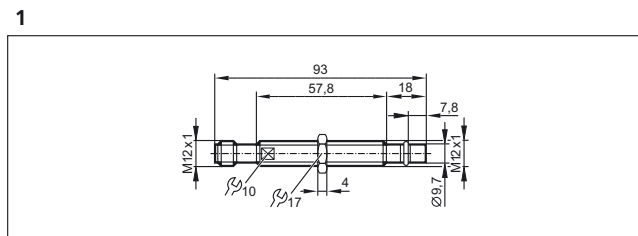

Scale drawings / drawing no. – CAD download: www.ifm.com

5

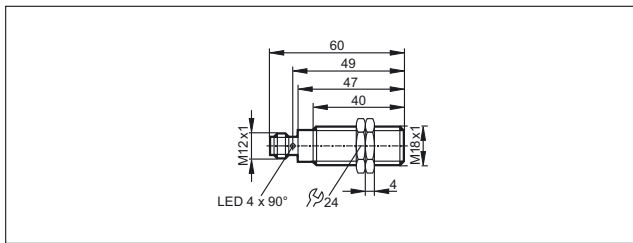

6

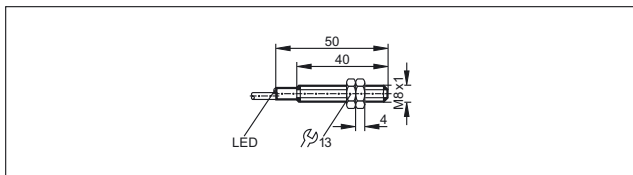

7

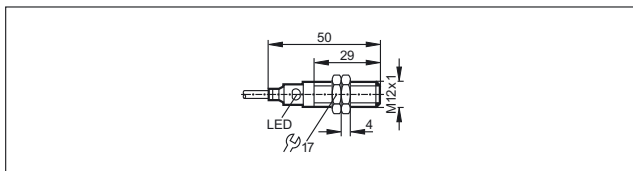

8

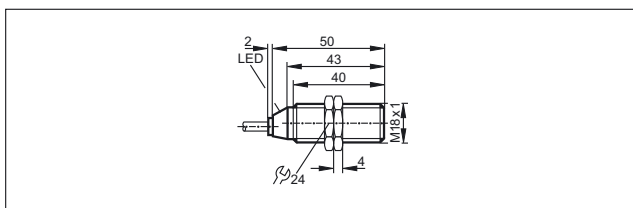

9

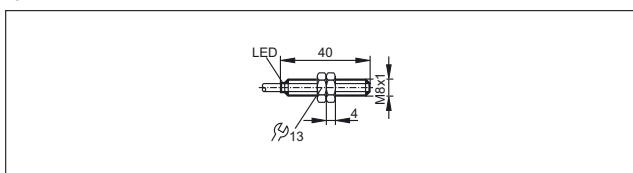

10

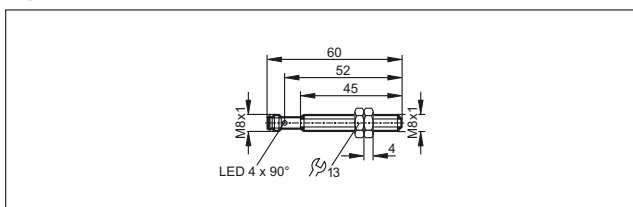

11

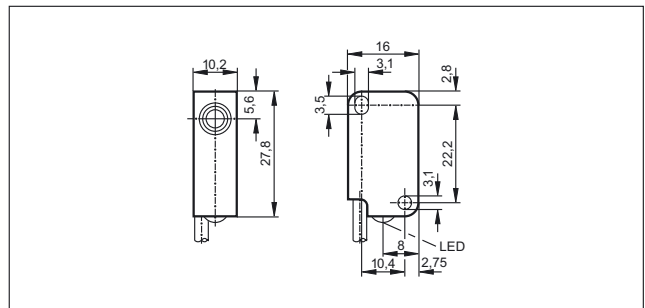

12

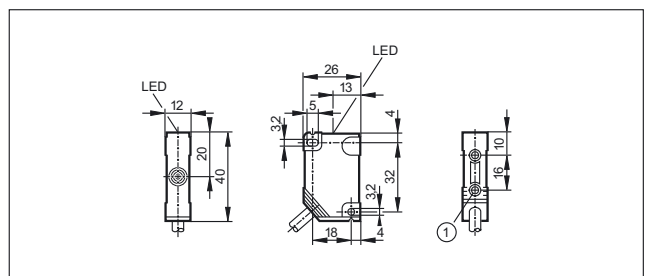

1: threaded insert M3, depth 5.8 mm, max. tightening torque 1.2 Nm (screw fixing class 8.8) when brass insert in contact with counterpart.

13

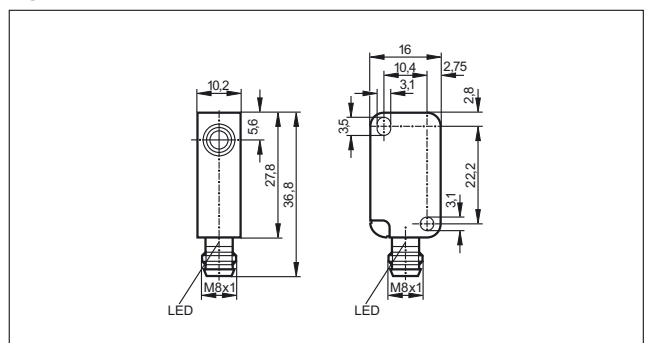

14

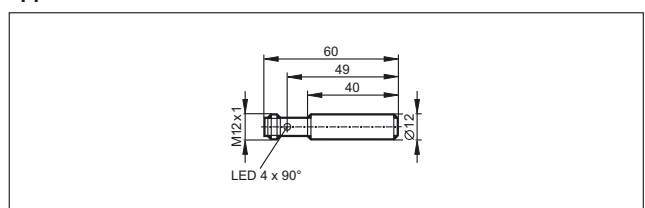





- Solid-state sensors for pneumatic cylinder position
- Self-clamping fixture for easy adjustment and quick mounting
- Easily inserted into the slot from the top
- Versions for standard and wet areas
- Adapters for other common cylinder types and makes

Cylinder sensors

Cylinder sensors are used for position detection of pistons in pneumatic cylinders. They are directly and robustly mounted into the cylinder T or C-slot. The ring magnet attached to the piston is sensed through the housing wall of non-magnetisable material (usually aluminium or stainless steel). ifm offers standard T-slot and C-slot solutions using adapters for the most common cylinder types and manufacturers.

Operating principle

ifm's cylinder sensors use state-of-the-art GMR or AMR technology as used in computer hard drives. A GMR element is made up of extremely thin magnetic layers, each separated by a nonmagnetic layer. Without external field they align in an anti-parallel manner which results in a defined electrical resistance. If these layers are exposed to a magnetic field, the magnetic layers align in a parallel manner. This results in a large change in resistance that is converted into a switching signal by the internal electronics. An AMR element consists of thin ferromagnetic stripes. Electrical resistance is highest without external magnetic fields. The effect of a magnetic field reduces resistance. This change is converted into a switching signal by the internal electronics. This method enables exact measurement of even very small changes of the magnetic field where space is extremely limited. This results in a smaller hysteresis and a short travel distance. So, the sensors can be used wherever exact positioning is required (e.g. short-stroke cylinder).

Response sensitivity

The response sensitivity applies equally to either magnetic polarity and without external field influence. The magnetic flux density in most pneumatic cylinders is between 5 and 25 millitesla (mT). ifm electronic's cylinder sensors are factory set so that they reliably detect these magnetic fields.

Travel distance

















The travel distance describes the section which is covered by the magnet in the sensing zone. It depends on the strength of the magnet. The short response times of the sensors allow very high travel speeds.

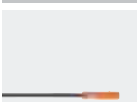

Position sensing: Cylinder sensors monitor the position of the piston in a pneumatic cylinder.

System overview	Page
T-slot sensors for industrial applications	182 - 183
T-slot reed sensors for industrial applications, 2-wire	183 - 184
T-slot reed sensors for industrial applications, 3-wire	184 - 185
T-slot sensors for hygienic and wet areas	185
T-slot sensors for short-stroke cylinders	186
T-slot sensors for short-stroke cylinders for hygienic and wet areas	187
T-slot sensors with ATEX approval 1G/1D	187
T-slot sensors with ATEX approval 3D/3G	187
T-slot sensors with ATEX approval 3D	187
T-slot reed sensors with ATEX approval 1G/1D	188
T-slot reed sensors with ATEX approval 3D/3G	188
T-slot sensors for welding applications, weld-field immune	188
Two T-slot sensors on one connector	188 - 189
Non flush C-slot sensors for industrial applications	189
Flush C-slot sensors for industrial applications	190
C-slot sensors for short-stroke cylinders	190 - 191
Fixing straps for clean line cylinders	191 - 192
Clips	192 - 193
Adapters for tie rod and integrated profile	193
Adapters for trapezoidal slot cylinders	194
Various adapters and memorisation blocks	194 - 195
Wiring diagrams	195 - 196
Scale drawings / drawing no. – CAD download: www.ifm.com	196 - 199

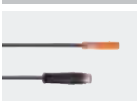
T-slot sensors for industrial applications

Type	Dimensions [mm]	Material	U _b [V]	f [Hz]	Protection	I _{load} [mA]	T _a [°C]	Drawing no.	Order no.
Cable 2 m · Output function  · 3-wire · DC PNP · Wiring diagram no. 1									
	25 x 5 x 6.5	PA (polyamide)	10...30	10000	IP 65 / IP 67	100	-25...85	1	MK5100
	25 x 5 x 6.5	PA (polyamide)	10...30	10000	IP 65 / IP 67	200	-25...85	1	MK5115
Cable 2 m · Output function  · 3-wire · DC NPN · Wiring diagram no. 2									
	25 x 5 x 6.5	PA (polyamide)	10...30	10000	IP 65 / IP 67	100	-25...85	1	MK5114
Cable 2 m · Output function  · 2-wire · DC PNP/NPN · Wiring diagram no. 3									
	25 x 5 x 6.5	PA (polyamide)	10...30	4000	IP 65 / IP 67	100	-25...85	1	MK5103
Cable 6 m · Output function  · 3-wire · DC PNP · Wiring diagram no. 1									
	25 x 5 x 6.5	PA (polyamide)	10...30	10000	IP 65 / IP 67	200	-25...85	1	MK5117
Cable 10 m · Output function  · 3-wire · DC PNP · Wiring diagram no. 1									
	25 x 5 x 6.5	PA (polyamide)	10...30	10000	IP 65 / IP 67	100	-25...85	1	MK5124
Cable 0.3 m · with M8 connector (snap-fit) · Output function  · 3-wire · DC PNP · Wiring diagram no. 4 · Connector groups 1, 2, 3, 72, 78, 120, 122									
	25 x 5 x 6.5	PA (polyamide)	10...30	10000	IP 65 / IP 67	100	-25...85	2	MK5101
	25 x 5 x 6.5	PA (polyamide)	10...30	10000	IP 65 / IP 67	200	-25...85	2	MK5106
Cable 0.3 m · with M8 connector (snap-fit) · Output function  · 3-wire · DC NPN · Wiring diagram no. 5 · Connector groups 1, 3, 72, 78, 120									
	25 x 5 x 6.5	PA (polyamide)	10...30	10000	IP 65 / IP 67	100	-25...85	2	MK5112
Cable 0.3 m · with M8 connector (snap-fit) · Output function  · 2-wire · DC PNP/NPN · Wiring diagram no. 6 · Connector groups 1, 3, 120									
	25 x 5 x 6.5	PA (polyamide)	10...30	4000	IP 65 / IP 67	100	-25...85	2	MK5104

Type	Dimensions [mm]	Material	U _b [V]	f [Hz]	Protection	I _{load} [mA]	T _a [°C]	Drawing no.	Order no.
------	--------------------	----------	-----------------------	-----------	------------	---------------------------	------------------------	----------------	--------------

Cable 0.3 m · with M8 connector · Output function  · 3-wire · DC PNP · Wiring diagram no. 4 · Connector groups 1, 2, 3, 72, 78, 120, 122

	25 x 5 x 6.5	PA (polyamide)	10...30	10000	IP 65 / IP 67	100	-25...85	3	MK5102
---	--------------	----------------	---------	-------	---------------	-----	----------	---	--------

Cable 0.3 m · with M12 connector · Output function  · 3-wire · DC PNP · Wiring diagram no. 4 · Connector groups 8, 10, 11, 18, 20, 120, 124, 126, 128, 130, 157, 158

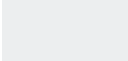
	25 x 5 x 6.5	PA (polyamide)	10...30	10000	IP 65 / IP 67	100	-25...85	4	MK5107
	25 x 5 x 6.5	PA (polyamide)	10...30	10000	IP 65 / IP 67	200	-25...85	4	MK5108

Cable 0.3 m · with M8 connector · Output function  · 2-wire · DC PNP/NPN · Wiring diagram no. 6 · Connector groups 1, 3, 120

	25 x 5 x 6.5	PA (polyamide)	10...30	4000	IP 65 / IP 67	100	-25...85	3	MK5105
---	--------------	----------------	---------	------	---------------	-----	----------	---	--------

Cable 0.3 m · with M12 connector · Output function  · 2-wire · DC PNP/NPN · Wiring diagram no. 6 · Connector groups 8, 10, 18, 20, 120, 124, 126, 128, 157

	25 x 5 x 6.5	PA (polyamide)	10...30	4000	IP 65 / IP 67	100	-25...85	4	MK5109
---	--------------	----------------	---------	------	---------------	-----	----------	---	--------

Cable 1 m · with M8 connector · Output function  · 3-wire · DC PNP · Wiring diagram no. 4 · Connector groups 1, 2, 3, 72, 78, 120, 122

	25 x 5 x 6.5	PA (polyamide)	10...30	10000	IP 65 / IP 67	100	-25...85	3	MK5122
---	--------------	----------------	---------	-------	---------------	-----	----------	---	--------

M8 connector · Output function  · 3-wire · DC PNP · Wiring diagram no. 4 · Connector groups 1, 2, 3, 72, 78, 120, 122

	27.5 x 18 x 15.5	PA (polyamide)	10...30	6000	IP 65 / IP 67	100	-25...85	5	MK5900
---	------------------	----------------	---------	------	---------------	-----	----------	---	--------

M8 connector · Output function  · 3-wire · DC NPN · Wiring diagram no. 5 · Connector groups 1, 3, 72, 78, 120

	27.5 x 18 x 15.5	PA (polyamide)	10...30	6000	IP 65 / IP 67	100	-25...85	5	MK5902
---	------------------	----------------	---------	------	---------------	-----	----------	---	--------









T-slot reed sensors for industrial applications, 2-wire

Type	Dimensions [mm]	Material	U _b [V]	f [Hz]	Protection	I _{load} [mA]	T _a [°C]	Drawing no.	Order no.
------	--------------------	----------	-----------------------	-----------	------------	---------------------------	------------------------	----------------	--------------

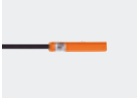
M8 connector · Output function  · 2-wire · AC/DC PNP/NPN · Wiring diagram no. 7 · Connector group --

	27.5 x 18 x 15.5	PA (polyamide)	5...50	1000	IP 65 / IP 67	100	-25...70	5	MR0901*
---	------------------	----------------	--------	------	---------------	-----	----------	---	---------







Position sensors





Type	Dimensions [mm]	Material	U _b [V]	f [Hz]	Protection	I _{load} [mA]	T _a [°C]	Drawing no.	Order no.
Cable 2 m · Output function  · 2-wire · AC/DC PNP/NPN · Wiring diagram no. 8									
	30.5 x 5 x 6.5	PA (polyamide)	5...120	1000	IP 65 / IP 67	100	-25...70	6	MR0100*
Cable 6 m · Output function  · 2-wire · AC/DC PNP/NPN · Wiring diagram no. 8									
	30.5 x 5 x 6.5	PA (polyamide)	5...120	1000	IP 65 / IP 67	100	-25...70	6	MR0117*
Cable 0.3 m · with M8 connector (snap-fit) · Output function  · 2-wire · AC/DC PNP/NPN · Wiring diagram no. 7 · Connector groups 1, 3, 120									
	30.5 x 5 x 6.5	PA (polyamide)	5...60	1000	IP 65 / IP 67	100	-25...70	7	MR0101*
Cable 0.3 m · with M8 connector · Output function  · 2-wire · AC/DC PNP/NPN · Wiring diagram no. 7 · Connector groups 1, 3, 120									
	30.5 x 5 x 6.5	PA (polyamide)	5...60	1000	IP 65 / IP 67	100	-25...70	8	MR0102*
Cable 0.3 m · with M12 connector · Output function  · 2-wire · AC/DC PNP/NPN · Wiring diagram no. 7 · Connector groups 8, 10, 18, 20, 120, 124, 126, 128, 157									
	30.5 x 5 x 6.5	PA (polyamide)	5...60	1000	IP 65 / IP 67	100	-25...70	9	MR0107*

* Note for AC and AC/DC units

Miniature fuse to IEC60127-2 sheet 1, $\leq 0,175$ A (fast acting) Recommendation: check the unit for reliable function after a short circuit.

T-slot reed sensors for industrial applications, 3-wire



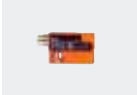





Type	Dimensions [mm]	Material	U _b [V]	f [Hz]	Protection	I _{load} [mA]	T _a [°C]	Drawing no.	Order no.
Cable 0.3 m · with M8 connector (snap-fit) · Output function  · 3-wire · AC/DC PNP · Wiring diagram no. 9 · Connector groups 1, 2, 3, 72, 78, 120, 122									
	30.5 x 5 x 6.5	PA (polyamide)	5...50	1000	IP 65 / IP 67	350 / 500	-25...70	7	MR0119*
Cable 0.3 m · with M8 connector · Output function  · 3-wire · AC/DC PNP · Wiring diagram no. 9 · Connector groups 1, 2, 3, 72, 78, 120, 122									
	30.5 x 5 x 6.5	PA (polyamide)	5...50	1000	IP 65 / IP 67	350 / 500	-25...70	8	MR0120*
Cable 2 m · Output function  · 3-wire · AC/DC PNP · Wiring diagram no. 10									
	30.5 x 5 x 6.5	PA (polyamide)	5...50	1000	IP 65 / IP 67	350 / 500	-25...70	6	MR0122*

Type	Dimensions [mm]	Material	U _b [V]	f [Hz]	Protection	I _{load} [mA]	T _a [°C]	Drawing no.	Order no.
Cable 6 m · Output function  · 3-wire · AC/DC PNP · Wiring diagram no. 10									
	30.5 x 5 x 6.5	PA (polyamide)	5...50	1000	IP 65 / IP 67	350 / 500	-25...70	6	MR0123*
Cable 0.3 m · with M12 connector · Output function  · 3-wire · AC/DC PNP · Wiring diagram no. 9 · Connector groups 8, 10, 11, 18, 20, 120, 124, 126, 128, 130, 157, 158									
	30.5 x 5 x 6.5	PA (polyamide)	5...50	1000	IP 65 / IP 67	350 / 500	-25...70	9	MR0121*
M8 connector · Output function  · 3-wire · AC/DC PNP · Wiring diagram no. 9 · Connector group --									
	27.5 x 18 x 15.5	PA (polyamide)	5...50	1000	IP 65 / IP 67	350 / 500	-25...70	5	MR0902*

*** Note for AC and AC/DC units**

Miniature fuse to IEC60127-2 sheet 1, $\leq 0,175$ A (fast acting) Recommendation: check the unit for reliable function after a short circuit.

T-slot sensors for hygienic and wet areas

Type	Dimensions [mm]	Material	U _b [V]	f [Hz]	Protection	I _{load} [mA]	T _a [°C]	Drawing no.	Order no.
Cable 2 m · Output function  · 3-wire · DC PNP · Wiring diagram no. 1									
	25 x 5 x 6.5	PA (polyamide)	10...30	10000	IP 65 / IP 67 / IP 69K	100	-25...85	1	MK5110
Cable 6 m · Output function  · 3-wire · DC PNP · Wiring diagram no. 1									
	25 x 5 x 6.5	PA (polyamide)	10...30	10000	IP 65 / IP 67 / IP 69K	100	-25...85	1	MK5128
Cable 0.3 m · with M12 connector · Output function  · 3-wire · DC PNP · Wiring diagram no. 4 · Connector groups 8, 10, 11, 18, 20, 120, 124, 126, 128, 130, 157, 158									
	25 x 5 x 6.5	PA (polyamide)	10...30	10000	IP 65 / IP 67 / IP 69K	100	-25...85	10	MK5111
Cable 0.3 m · with M12 connector · Output function  · 3-wire · DC NPN · Wiring diagram no. 5 · Connector groups 8, 10, 18, 20, 120, 124, 126, 128, 157									
	25 x 5 x 6.5	PA (polyamide)	10...30	6000	IP 65 / IP 67 / IP 69K	100	-25...85	11	MK5186

T-slot sensors for short-stroke cylinders

Type	Dimensions [mm]	Material	U _b [V]	f [Hz]	Protection	I _{load} [mA]	T _a [°C]	Drawing no.	Order no.
Cable 2 m · Output function  · 3-wire · DC PNP · Wiring diagram no. 1									
	25 x 5 x 6.5	PA (polyamide)	10...30	6000	IP 65 / IP 67	100	-25...85	12	MK5140
Cable 2 m · Output function  · 3-wire · DC PNP · Wiring diagram no. 11									
	25 x 5 x 6.5	PA (polyamide)	10...30	6000	IP 65 / IP 67	100	-25...85	12	MK5156
Cable 10 m · Output function  · 3-wire · DC PNP · Wiring diagram no. 1									
	25 x 5 x 6.5	PA (polyamide)	10...30	6000	IP 65 / IP 67	100	-25...85	12	MK5161
Cable 0.3 m · with M8 connector (snap-fit) · Output function  · 3-wire · DC NPN · Wiring diagram no. 5 · Connector groups 1, 3, 72, 78, 120									
	25 x 5 x 6.5	PA (polyamide)	10...30	6000	IP 65 / IP 67	100	-25...85	13	MK5137
Cable 0.3 m · with M8 connector (snap-fit) · Output function  · 3-wire · DC PNP · Wiring diagram no. 4 · Connector groups 1, 2, 3, 72, 78, 120, 122									
	25 x 5 x 6.5	PA (polyamide)	10...30	6000	IP 65 / IP 67	100	-25...85	13	MK5138
Cable 0.3 m · with M8 connector (snap-fit) · Output function  · 3-wire · DC PNP · Wiring diagram no. 12 · Connector groups 1, 2, 3, 72, 78, 120, 122									
	25 x 5 x 6.5	PA (polyamide)	10...30	6000	IP 65 / IP 67	100	-25...85	13	MK5155
Cable 0.3 m · with M8 connector · Output function  · 3-wire · DC PNP · Wiring diagram no. 4 · Connector groups 1, 2, 3, 72, 78, 120, 122									
	25 x 5 x 6.5	PA (polyamide)	10...30	6000	IP 65 / IP 67	100	-25...85	14	MK5159
Cable 0.3 m · with M12 connector · Output function  · 3-wire · DC PNP · Wiring diagram no. 4 · Connector groups 8, 10, 11, 18, 20, 120, 124, 126, 128, 130, 157, 158									
	25 x 5 x 6.5	PA (polyamide)	10...30	6000	IP 65 / IP 67	100	-25...85	15	MK5139

T-slot sensors for short-stroke cylinders for hygienic and wet areas

Type	Dimensions [mm]	Material	U _b [V]	f [Hz]	Protection	I _{load} [mA]	T _a [°C]	Drawing no.	Order no.
------	--------------------	----------	-----------------------	-----------	------------	---------------------------	------------------------	----------------	--------------

Cable 2 m · Output function  · 3-wire · DC PNP · Wiring diagram no. 1

	25 x 5 x 6.5	PA (polyamide)	10...30	6000	IP 65 / IP 67 / IP 69K	100	-25...85	12	MK5158
---	--------------	----------------	---------	------	---------------------------	-----	----------	----	--------

Cable 0.3 m · with M12 connector · Output function  · 3-wire · DC PNP · Wiring diagram no. 4 · Connector groups 8, 10, 11, 18, 20, 120, 124, 126, 128, 130, 157, 158

	25 x 5 x 6.5	PA (polyamide)	10...30	6000	IP 65 / IP 67 / IP 69K	100	-25...85	11	MK5157
---	--------------	----------------	---------	------	---------------------------	-----	----------	----	--------

T-slot sensors with ATEX approval 1G/1D

Type	Dimensions [mm]	Material	U _b [V]	f [Hz]	Protection	I _{load} [mA]	T _a [°C]	Drawing no.	Order no.
------	--------------------	----------	-----------------------	-----------	------------	---------------------------	------------------------	----------------	--------------

Cable 6 m · Output function  · 2-wire · Connection to certified intrinsically safe circuits with the max. values U = 15 V / I = 50 mA / P = 120 mW · Wiring diagram no. 3

	25 x 5 x 6.5	PA (polyamide)	–	2000	IP 65 / IP 67	–	-25...70	12	MK502A
---	--------------	----------------	---	------	---------------	---	----------	----	--------

T-slot sensors with ATEX approval 3D/3G

Type	Dimensions [mm]	Material	U _b [V]	f [Hz]	Protection	I _{load} [mA]	T _a [°C]	Drawing no.	Order no.
------	--------------------	----------	-----------------------	-----------	------------	---------------------------	------------------------	----------------	--------------

Cable 6 m · Output function  · 3-wire · DC PNP · Wiring diagram no. 1

	25 x 5 x 6.5	PA (polyamide)	10...30	6000	IP 65 / IP 67	100	-20...60	12	MK503A
---	--------------	----------------	---------	------	---------------	-----	----------	----	--------

T-slot sensors with ATEX approval 3D

Type	Dimensions [mm]	Material	U _b [V]	f [Hz]	Protection	I _{load} [mA]	T _a [°C]	Drawing no.	Order no.
------	--------------------	----------	-----------------------	-----------	------------	---------------------------	------------------------	----------------	--------------

Cable 2 m · Output function  · 3-wire · DC PNP · Wiring diagram no. 1

	25 x 5 x 6.5	PA (polyamide)	10...30	10000	IP 65 / IP 67	100	-25...60	1	MK500A
---	--------------	----------------	---------	-------	---------------	-----	----------	---	--------

Cable 0.3 m · with M12 connector · Output function  · 3-wire · DC PNP · Wiring diagram no. 4 · Connector groups 154, 156

	25 x 5 x 6.5	PA (polyamide)	10...30	10000	IP 65 / IP 67	100	-25...60	10	MK501A
---	--------------	----------------	---------	-------	---------------	-----	----------	----	--------

T-slot reed sensors with ATEX approval 1G/1D

Type	Dimensions [mm]	Material	U _b [V]	f [Hz]	Protection	I _{load} [mA]	T _a [°C]	Drawing no.	Order no.
------	--------------------	----------	-----------------------	-----------	------------	---------------------------	------------------------	----------------	--------------

Cable 6 m · Output function  · 2-wire · Connection to certified intrinsically safe circuits with the max. values U = 15 V / I = 50 mA / P = 120 mW · Wiring diagram no. 3

	30.5 x 5 x 6.5	PA (polyamide)	-	-	IP 65 / IP 67	-	-25...70	6	MR500A
---	----------------	----------------	---	---	---------------	---	----------	---	--------

T-slot reed sensors with ATEX approval 3D/3G

Type	Dimensions [mm]	Material	U _b [V]	f [Hz]	Protection	I _{load} [mA]	T _a [°C]	Drawing no.	Order no.
------	--------------------	----------	-----------------------	-----------	------------	---------------------------	------------------------	----------------	--------------

Cable 6 m · Output function  · 2-wire · DC PNP/NPN · Wiring diagram no. 13

	30.5 x 5 x 6.5	PA (polyamide)	5...30	-	IP 65 / IP 67	100	-20...60	6	MR501A*
---	----------------	----------------	--------	---	---------------	-----	----------	---	---------

*** Note for AC and AC/DC units**

Miniature fuse to IEC60127-2 sheet 1, ≤ 0,175 A (fast acting) Recommendation: check the unit for reliable function after a short circuit.

T-slot sensors for welding applications, weld-field immune

Type	Dimensions [mm]	Material	U _b [V]	f [Hz]	Protection	I _{load} [mA]	T _a [°C]	Drawing no.	Order no.
------	--------------------	----------	-----------------------	-----------	------------	---------------------------	------------------------	----------------	--------------

Cable 0.3 m · with M12 connector · Output function  · 3-wire · DC PNP · Wiring diagram no. 4 · Connector groups 114, 115, 116, 117

	25 x 5 x 6.5	PA (polyamide)	10...30	9	IP 65 / IP 67	100	-25...85	4	MK5214
---	--------------	----------------	---------	---	---------------	-----	----------	---	--------

Cable 0.3 m · with M8 connector · Output function  · 3-wire · DC PNP · Wiring diagram no. 4 · Connector group --



	25 x 5 x 6.5	PA (polyamide)	10...30	9	IP 65 / IP 67	100	-25...85	3	MK5215
---	--------------	----------------	---------	---	---------------	-----	----------	---	--------

Two T-slot sensors on one connector











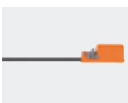

Type	Dimensions [mm]	Material	U _b [V]	f [Hz]	Protection	I _{load} [mA]	T _a [°C]	Drawing no.	Order no.
------	--------------------	----------	-----------------------	-----------	------------	---------------------------	------------------------	----------------	--------------

Cable 0.3 m · with M8 connector · Output function  · 4-wire · DC PNP · Wiring diagram no. 14 · Connector groups 4, 5, 74, 80, 124









	25 x 5 x 6.5	PA (polyamide)	10...30	6000	IP 65 / IP 67	100	-25...85	16	MK5208
---	--------------	----------------	---------	------	---------------	-----	----------	----	--------

Type	Dimensions [mm]	Material	U _b [V]	f [Hz]	Protection	I _{load} [mA]	T _a [°C]	Drawing no.	Order no.
Cable 0.3 m · with M12 connector · Output function  · 4-wire · DC PNP · Wiring diagram no. 14 · Connector groups 8, 9, 10, 11, 18, 20, 120, 124, 126, 128, 130, 131, 157, 158									
	25 x 5 x 6.5	PA (polyamide)	10...30	6000	IP 65 / IP 67	100	-25...85	17	MK5209

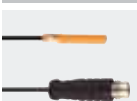
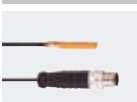

Non flush C-slot sensors for industrial applications

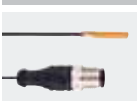

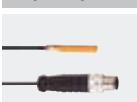







Type	Dimensions [mm]	Material	U _b [V]	f [Hz]	Protection	I _{load} [mA]	T _a [°C]	Drawing no.	Order no.
Cable 2 m · Output function  · 3-wire · DC PNP · Wiring diagram no. 1									
	17.5 x 2.8 x 7.7	PA (polyamide)	10...30	10000	IP 65 / IP 67	100	-25...85	18	MK5300
Cable 2 m · Output function  · 3-wire · DC NPN · Wiring diagram no. 2									
	17.5 x 2.8 x 7.7	PA (polyamide)	10...30	10000	IP 65 / IP 67	100	-25...85	18	MK5306
Cable 0.3 m · with M8 connector (snap-fit) · Output function  · 3-wire · DC PNP · Wiring diagram no. 4 · Connector groups 1, 2, 3, 72, 78, 120, 122									
	17.5 x 2.8 x 7.7	PA (polyamide)	10...30	10000	IP 65 / IP 67	100	-25...85	19	MK5301
Cable 0.3 m · with M8 connector (snap-fit) · Output function  · 3-wire · DC NPN · Wiring diagram no. 5 · Connector groups 1, 3, 72, 78, 120									
	17.5 x 2.8 x 7.7	PA (polyamide)	10...30	10000	IP 65 / IP 67	100	-25...85	19	MK5307
Cable 0.3 m · with M8 connector · Output function  · 3-wire · DC PNP · Wiring diagram no. 4 · Connector groups 1, 2, 3, 72, 78, 120, 122									
	17.5 x 2.8 x 7.7	PA (polyamide)	10...30	10000	IP 65 / IP 67	100	-25...85	20	MK5302
Cable 0.5 m · with M8 connector · Output function  · 3-wire · DC PNP · Wiring diagram no. 4 · Connector groups 1, 2, 3, 72, 78, 120, 122									
	17.5 x 2.8 x 7.7	PA (polyamide)	10...30	10000	IP 65 / IP 67	100	-25...85	20	MK5305
Cable 0.3 m · with M12 connector · Output function  · 3-wire · DC PNP · Wiring diagram no. 4 · Connector groups 8, 10, 11, 18, 20, 120, 124, 126, 128, 130, 157, 158									
	17.5 x 2.8 x 7.7	PA (polyamide)	10...30	10000	IP 65 / IP 67	100	-25...85	21	MK5304

Flush C-slot sensors for industrial applications

Type	Dimensions [mm]	Material	U _b [V]	f [Hz]	Protection	I _{load} [mA]	T _a [°C]	Drawing no.	Order no.
Cable 2 m · Output function  · 3-wire · DC PNP · Wiring diagram no. 1									
	25.8 x 2.8 x 5	PA (polyamide)	10...30	10000	IP 65 / IP 67	100	-25...85	22	MK5312
Cable 2 m · Output function  · 3-wire · DC NPN · Wiring diagram no. 2									
	25.8 x 2.8 x 5	PA (polyamide)	10...30	10000	IP 65 / IP 67	100	-25...85	22	MK5309
Cable 0.3 m · with M8 connector (snap-fit) · Output function  · 3-wire · DC PNP · Wiring diagram no. 4 · Connector groups 1, 2, 3, 72, 78, 120, 122									
	25.8 x 2.8 x 5	PA (polyamide)	10...30	10000	IP 65 / IP 67	100	-25...85	23	MK5310
Cable 0.3 m · with M8 connector · Output function  · 3-wire · DC PNP · Wiring diagram no. 4 · Connector groups 1, 2, 3, 72, 78, 120, 122									
	25.8 x 2.8 x 5	PA (polyamide)	10...30	10000	IP 65 / IP 67	100	-25...85	24	MK5311
Cable 0.3 m · with M12 connector · Output function  · 3-wire · DC PNP · Wiring diagram no. 4 · Connector groups 8, 10, 11, 18, 20, 120, 124, 126, 128, 130, 157, 158									
	25.8 x 2.8 x 5	PA (polyamide)	10...30	10000	IP 65 / IP 67	100	-25...85	25	MK5314
Cable 0.3 m · with M8 connector (snap-fit) · Output function  · 3-wire · DC NPN · Wiring diagram no. 5 · Connector groups 1, 3, 72, 78, 120									
	25.8 x 2.8 x 5	PA (polyamide)	10...30	10000	IP 65 / IP 67	100	-25...85	23	MK5308
Cable 0.5 m · with M8 connector · Output function  · 3-wire · DC PNP · Wiring diagram no. 4 · Connector groups 1, 2, 3, 72, 78, 120, 122									
	25.8 x 2.8 x 5	PA (polyamide)	10...30	10000	IP 65 / IP 67	100	-25...85	24	MK5315

C-slot sensors for short-stroke cylinders



Type	Dimensions [mm]	Material	U _b [V]	f [Hz]	Protection	I _{load} [mA]	T _a [°C]	Drawing no.	Order no.
Cable 2 m · Output function  · 3-wire · DC PNP · Wiring diagram no. 1									
	25.8 x 2.8 x 5	PA (polyamide)	10...30	5000	IP 65 / IP 67	100	-25...85	22	MK5325

Type	Dimensions [mm]	Material	U _b [V]	f [Hz]	Protection	I _{load} [mA]	T _a [°C]	Drawing no.	Order no.
Cable 0.3 m · with M8 connector (snap-fit) · Output function  · 3-wire · DC PNP · Wiring diagram no. 4 · Connector groups 1, 2, 3, 72, 78, 120, 122									
	25.8 x 2.8 x 5	PA (polyamide)	10...30	5000	IP 65 / IP 67	100	-25...85	23	MK5326
Cable 0.3 m · with M8 connector · Output function  · 3-wire · DC PNP · Wiring diagram no. 4 · Connector groups 1, 2, 3, 72, 78, 120, 122									
	25.8 x 2.8 x 5	PA (polyamide)	10...30	5000	IP 65 / IP 67	100	-25...85	24	MK5328
Cable 2 m · Output function  · 3-wire · DC PNP · Wiring diagram no. 1									
	17.5 x 2.8 x 7.7	PA (polyamide)	10...30	5000	IP 65 / IP 67	100	-25...85	26	MK5329
Cable 0.3 m · with M8 connector (snap-fit) · Output function  · 3-wire · DC PNP · Wiring diagram no. 4 · Connector groups 1, 2, 3, 72, 78, 120, 122									
	17.5 x 2.8 x 7.7	PA (polyamide)	10...30	5000	IP 65 / IP 67	100	-25...85	27	MK5330
Cable 0.3 m · with M8 connector · Output function  · 3-wire · DC PNP · Wiring diagram no. 4 · Connector groups 1, 2, 3, 72, 78, 120, 122									
	17.5 x 2.8 x 7.7	PA (polyamide)	10...30	5000	IP 65 / IP 67	100	-25...85	28	MK5331

Fixing straps for clean line cylinders

Type	Description	Order no.
	Fixing strap for clean-line cylinders · Piston diameter 8...12 mm · for type MKT · Housing materials: adapter: PA / Fixing strap: stainless steel	E11816
	Fixing strap for clean-line cylinders · Piston diameter 16...20 mm · for type MKT · Housing materials: adapter: PA / Fixing strap: stainless steel	E11817
	Fixing strap for clean-line cylinders · Piston diameter 25...32 mm · for type MKT · Housing materials: adapter: PA / Fixing strap: stainless steel	E11818
	Fixing strap for clean-line cylinders · Piston diameter 40 mm · for type MKT · Housing materials: adapter: PA / Fixing strap: stainless steel	E11819
	Fixing strap for clean-line cylinders · Piston diameter 50 mm · for type MKT · Housing materials: adapter: PA / Fixing strap: stainless steel	E11820
	Fixing strap for clean-line cylinders · Piston diameter 63 mm · for type MKT · Housing materials: adapter: PA / Fixing strap: stainless steel	E11821

Position sensors

Type	Description	Order no.
	Fixing strap for clean-line cylinders · Piston diameter 80 mm · for type MKT · Housing materials: adapter: PA / Fixing strap: stainless steel	E11822
	Fixing strap for clean-line cylinders · Piston diameter 100 mm · for type MKT · Housing materials: adapter: PA / Fixing strap: stainless steel	E11823
	Fixing strap for clean-line cylinders · Piston diameter 10...16 mm · for type MKT · Housing materials: adapter: stainless steel / Fixing strap: stainless steel	E11975
	Fixing strap for clean-line cylinders · Piston diameter 20...25 mm · for type MKT · Housing materials: adapter: stainless steel / Fixing strap: stainless steel	E11976
	Fixing strap for clean-line cylinders · Piston diameter 32 mm · for type MKT · Housing materials: adapter: stainless steel / Fixing strap: stainless steel	E11977
	Fixing strap for clean-line cylinders · Piston diameter 40 mm · for type MKT · Housing materials: adapter: stainless steel / Fixing strap: stainless steel	E11978
	Fixing strap for clean-line cylinders · Piston diameter 50 mm · for type MKT · Housing materials: adapter: stainless steel / Fixing strap: stainless steel	E11979
	Fixing strap for clean-line cylinders · Piston diameter 63 mm · for type MKT · Housing materials: adapter: stainless steel / Fixing strap: stainless steel	E11980
	Fixing strap for clean-line cylinders · Piston diameter 80 mm · for type MKT · Housing materials: adapter: stainless steel / Fixing strap: stainless steel	E11981
	Fixing strap for clean-line cylinders · Piston diameter 100 mm · for type MKT · Housing materials: adapter: stainless steel / Fixing strap: stainless steel	E11982
	Adapter for clean-line cylinders · for types MKT (T-slot cylinder sensors) · Housing materials: PA	E11846
	Adapter for clean-line cylinders · for types MKT (T-slot cylinder sensors) · Housing materials: stainless steel	E11877

Clips





Type	Description	Order no.
	Clip · for types MKT (T-slot cylinder sensors) · Piston diameter 12 mm · Housing materials: POM / fixture: aluminium / screw: stainless steel	E11961
	Clip · for types MKT (T-slot cylinder sensors) · Piston diameter 16 mm · Housing materials: POM / fixture: aluminium / screw: stainless steel	E11958

Type	Description	Order no.
	Clip · for types MKT (T-slot cylinder sensors) · Piston diameter 20 mm · Housing materials: POM / fixture: aluminium / screw: stainless steel	E11959
	Clip · for types MKT and MKI (T-slot cylinder sensors) · Piston diameter 25 mm · Housing materials: POM / fixture: aluminium / screw: stainless steel	E11960
	Clip · for types MKT (T-slot cylinder sensors) · Clamping range 40-45 mm · Piston diameter 40 mm · Housing materials: POM / fixture: aluminium / screw: stainless steel	E12015
	Clip · for types MKT (T-slot cylinder sensors) · Clamping range 35-36 mm · Piston diameter 32 mm · Housing materials: POM / fixture: aluminium / screw: stainless steel	E12017









Adapters for tie rod and integrated profile





Type	Description	Order no.
	Adapter for tie rod / integrated profile cylinders · for types MKT (T-slot cylinder sensors) · Clamping range 5...11 mm · Housing materials: aluminium / screw: stainless steel	E11797
	Adapter for tie rod / integrated profile cylinders · for types MKT (T-slot cylinder sensors) · Clamping range 9...15 mm · Housing materials: aluminium / screw: stainless steel	E11799
	Adapter for tie rod / integrated profile cylinders · for types MKT (T-slot cylinder sensors) · Clamping range 14...20 mm · Housing materials: aluminium / screw: stainless steel	E11801
	Adapter for tie rod cylinders (or cylinders of the same dimensions) · for types MKT (T-slot cylinder sensors) · Clamping range 3...7 mm · Housing materials: aluminium / screw: stainless steel	E11913
	Adapter for tie rod cylinders (or cylinders of the same dimensions) · for types MKT (T-slot cylinder sensors) · Clamping range 5...7 mm · Housing materials: aluminium / screw: stainless steel	E11912
	Adapter for tie rod / integrated profile cylinders · for types MKT (T-slot cylinder sensors) · Clamping range 5...11 mm · Housing materials: aluminium / screw: stainless steel	E12231
	Adapter for tie rod / integrated profile cylinders · for types MKT (T-slot cylinder sensors) · Clamping range 9...13.5 mm · Housing materials: aluminium / screw: stainless steel	E12232
	Adapter for tie rod / integrated profile cylinders · for types MKT (T-slot cylinder sensors) · Clamping range 9...17 mm · Housing materials: aluminium / screw: stainless steel	E12233
	Adapter for tie rod / integrated profile cylinders · for types MKT (T-slot cylinder sensors) · Clamping range 13...15 mm · Housing materials: aluminium / screw: stainless steel	E12234

Adapters for trapezoidal slot cylinders

Type	Description	Order no.
	Adapter for trapezoidal slot cylinders · for types MKT (T-slot cylinder sensors) · Housing materials: aluminium alloy / set screw: stainless steel	E11796
	Adapter for trapezoidal slot cylinders · for types MKT (T-slot cylinder sensors) · Housing materials: aluminium alloy / set screw: stainless steel	E11957
	Adapter for trapezoidal slot cylinders · for types MKT (T-slot cylinder sensors) · Housing materials: aluminium alloy / set screw: stainless steel	E11988
	Adapter for Pneumax cylinders 1500 series (or cylinders of the same dimensions) · for types MKT / MRT (T-slot cylinder sensors) · Housing materials: aluminium	E12375

Various adapters and memorisation blocks

Type	Description	Order no.
	Adapter for Bosch Rexroth cylinders ICL series and Festo cylinders type CDN · for types MKT (T-slot cylinder sensors) · Housing materials: adapter: aluminium anodised / screw: stainless steel	E12164
	Adapter for Bosch-Rexroth cylinders PRA / PRB series (or cylinders of the same dimensions) · for types MKT (T-slot cylinder sensors) · Housing materials: aluminium / screw: stainless steel	E11892
	Adapter for Bosch-Rexroth cylinders 523 series (or cylinders of the same dimensions) · for types MKT (T-slot cylinder sensors) · L-slot · Housing materials: aluminium / screw: stainless steel	E11894
	Adapter for SMC cylinders ECDQ2 series (or cylinders of the same dimensions) · for types MKT (T-slot cylinder sensors) · T-slot rail, flat · Housing materials: aluminium / screw: stainless steel	E11890
	Adapter for SMC cylinders CDQ2 series (or cylinders of the same dimensions) · for types MKT (T-slot cylinder sensors) · T-slot rail, high · Housing materials: aluminium / screw: stainless steel	E11891
	Adapter for SMC cylinder CP95 · for types MKT (T-slot cylinder sensors) · Housing materials: stainless steel	E11872
	Adapter for Festo cylinders type DZH (or cylinders of the same dimensions) · for types MKT (T-slot cylinder sensors) · Housing materials: aluminium / screw: stainless steel	E11895
	Adapter for Norgren cylinders of the M series · for types MKT (T-slot cylinder sensors) · Housing materials: stainless steel	E12218
	Protective adapter for T-slot cylinder sensors · for types MKT (T-slot cylinder sensors) · Housing materials: diecast zinc coated / screws: stainless steel	E12259

Type	Description	Order no.
	T-slot adapter for C-slot sensor · for types MKC (C-slot cylinder sensor) for installation in T-slot cylinders · (height 5 mm) · Housing materials: diecast zinc / fixing element: stainless steel	E11928
	T-slot adapter for C-slot sensor · for types MKC (C-slot cylinder sensor) for installation in T-slot cylinders · (height 7.7 mm) · Housing materials: diecast zinc / fixing element: stainless steel	E11914
	T-slot cylinder memorisation block · for types MKT (T-slot cylinder sensors) · Housing materials: PA / stainless steel	E11798
	C-slot cylinder memorisation block · for types MKC (C-slot cylinder sensors) · Housing materials: PA / stainless steel	E12004

Wiring diagrams

Core colours

BK black
 BN brown
 BU blue

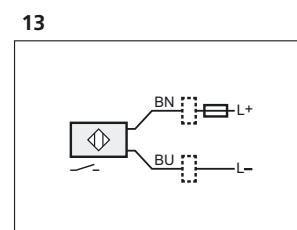
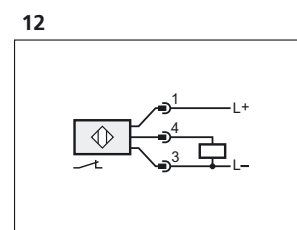
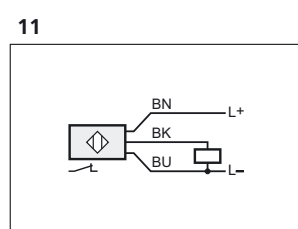
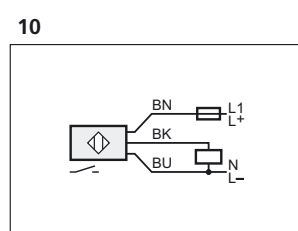
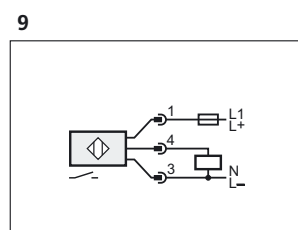
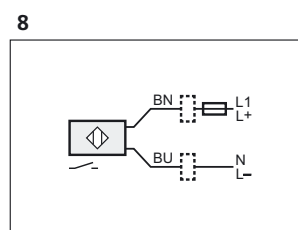
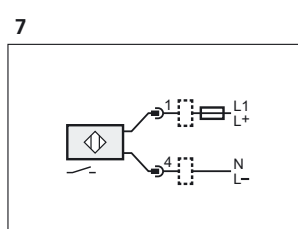
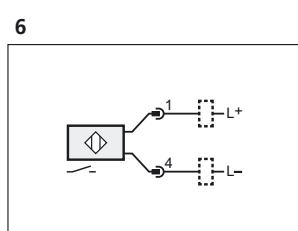
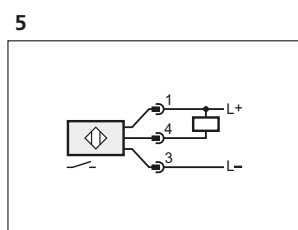
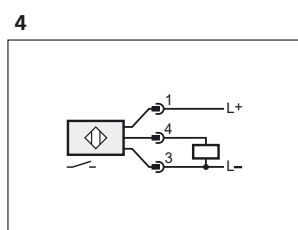
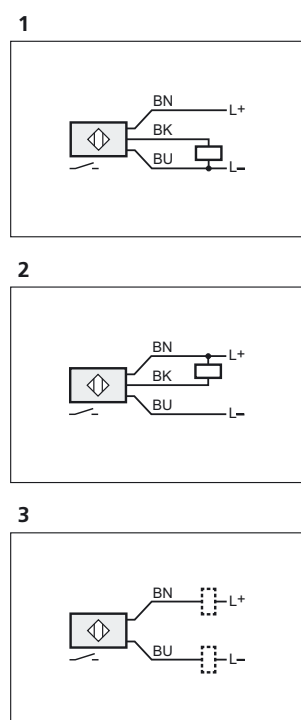

Note: miniature fuse to IEC60127-2 sheet 1,, ≤ 0,175 A (fast acting)

Wiring diagrams

14

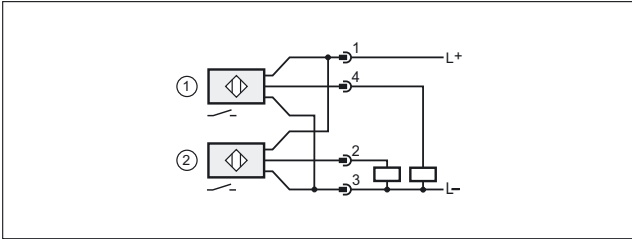

1: sensor 1, 2: sensor 2

Scale drawings / drawing no. – CAD download: www.ifm.com

1

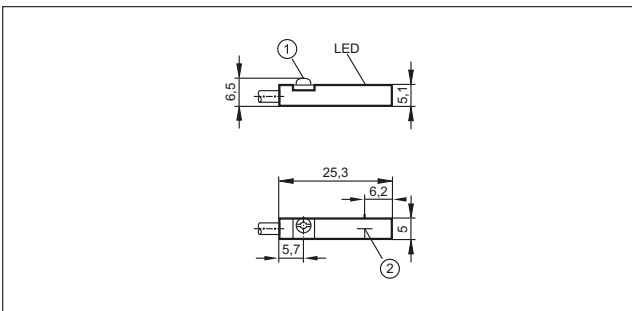

1: Fastening clamp, 2: sensing face

4

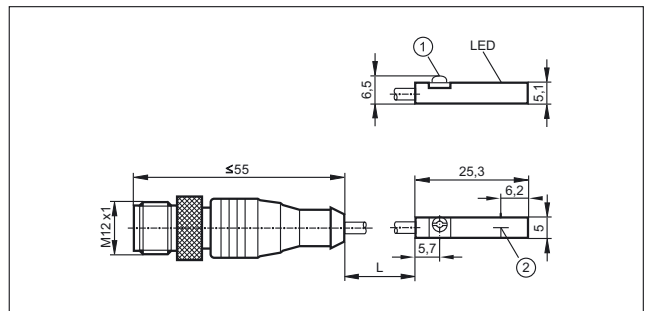

1: Fastening clamp, 2: sensing face

2

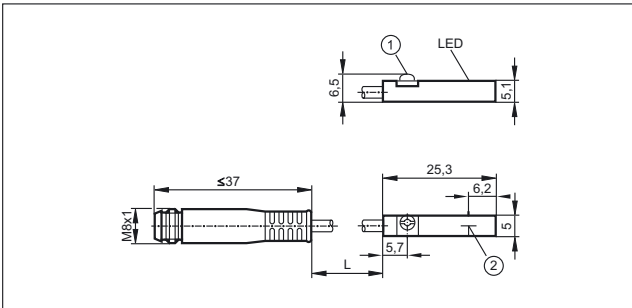

1: Fastening clamp, 2: sensing face

5

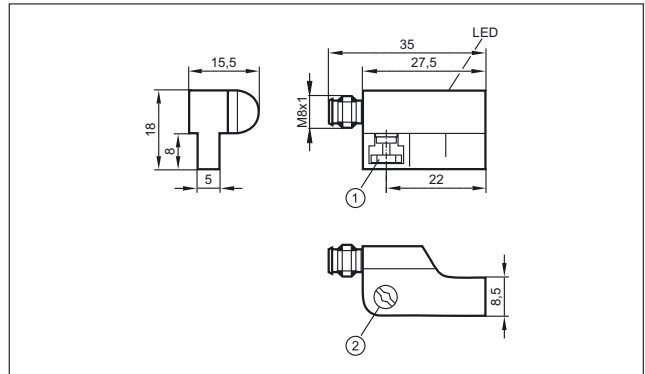

1: fixing element, 2: combined head screw for fixing element

3

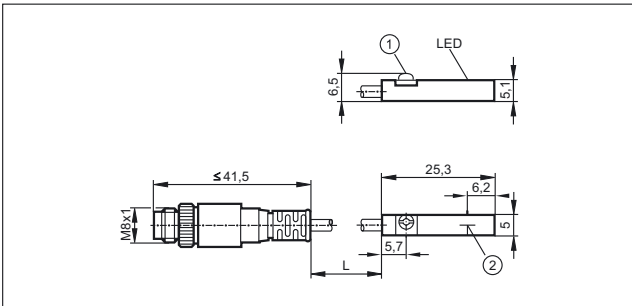

1: Fastening clamp, 2: sensing face

6

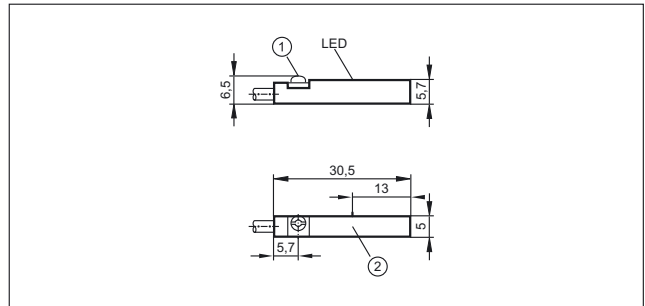

1: Clamping screw with combined slot/hexagon socket head AF 1.5, 2: sensing face

Scale drawings / drawing no. – CAD download: www.ifm.com

7

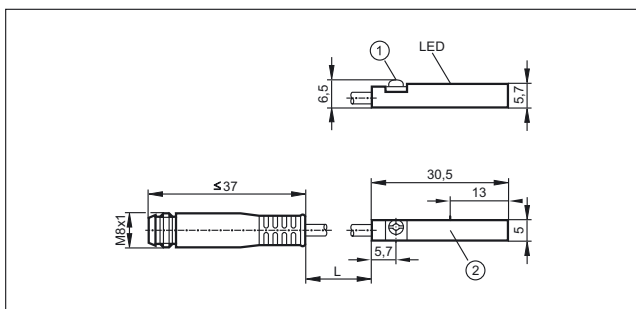

1: Clamping screw with combined slot/hexagon socket head AF 1.5, 2: sensing face

8

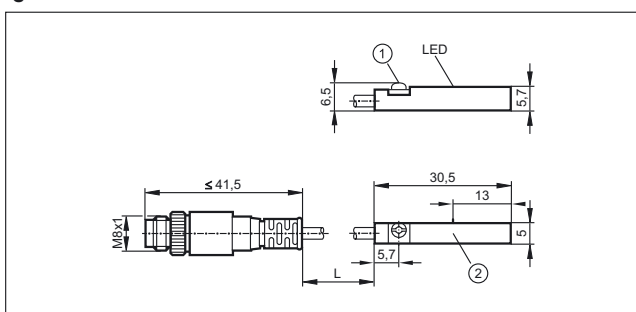

1: Clamping screw with combined slot/hexagon socket head AF 1.5, 2: sensing face

9

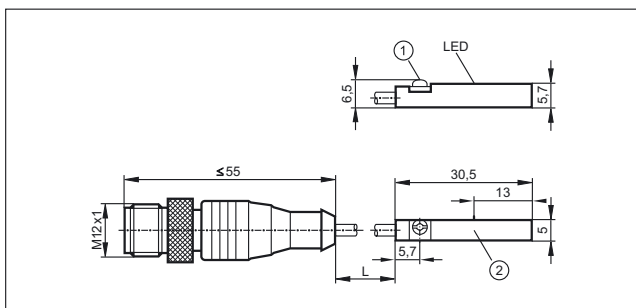

1: Clamping screw with combined slot/hexagon socket head AF 1.5, 2: sensing face

10

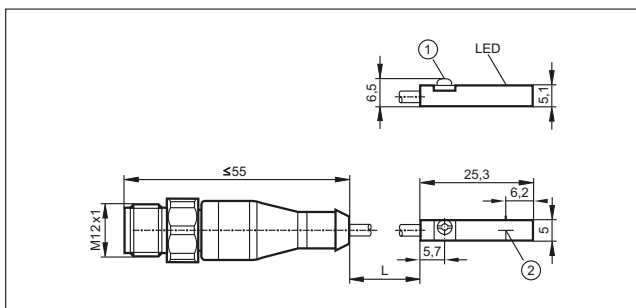

1: Fastening clamp, 2: sensing face

11

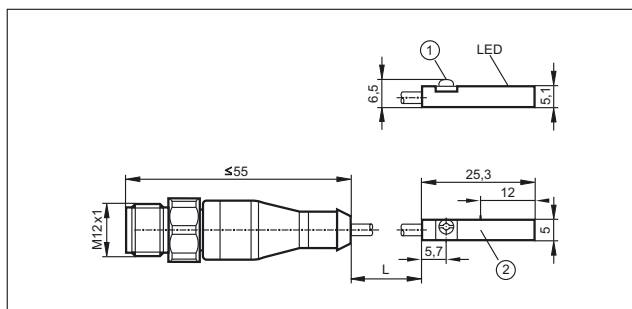

1: Fastening clamp, 2: sensing face

12

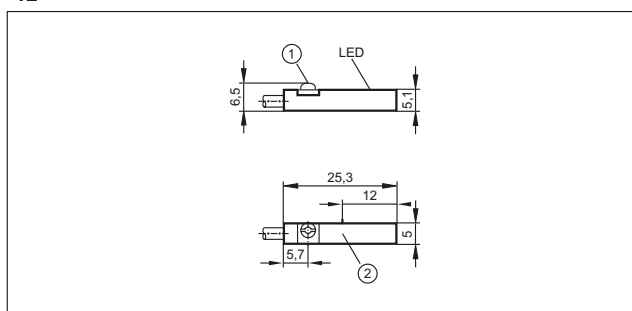

1: Fastening clamp, 2: sensing face

13

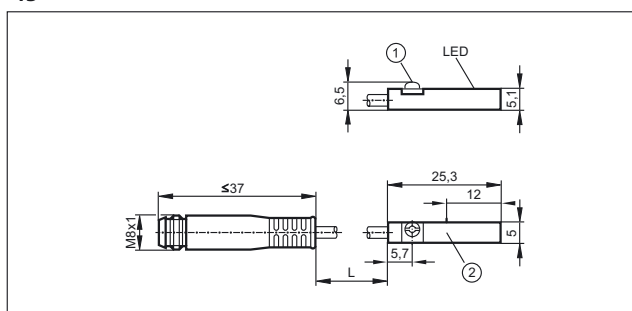

1: Fastening clamp, 2: sensing face

14

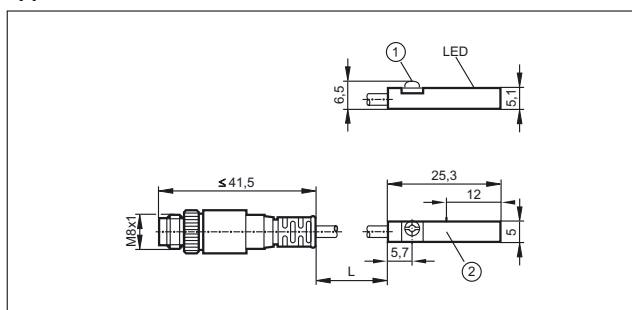

1: Fastening clamp, 2: sensing face

Scale drawings / drawing no. – CAD download: www.ifm.com

15

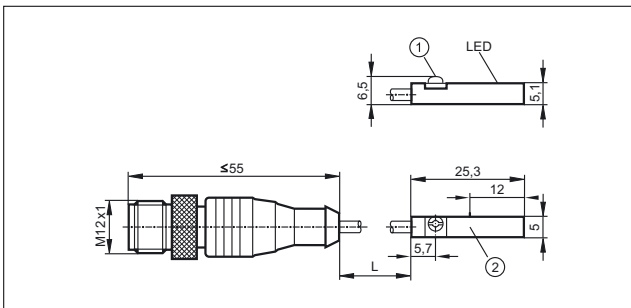

1: Fastening clamp, 2: sensing face

16

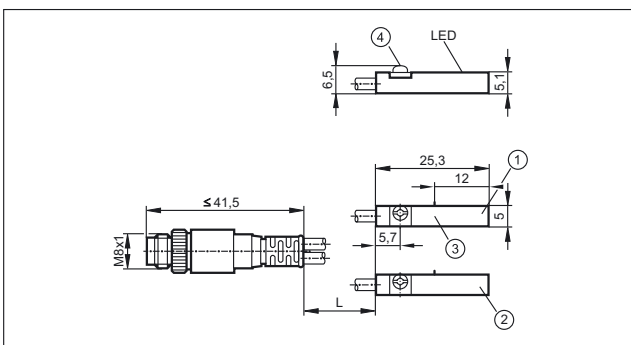

1: sensor 1, 2: sensor 2, 3: sensing face, 4: Fastening clamp

17

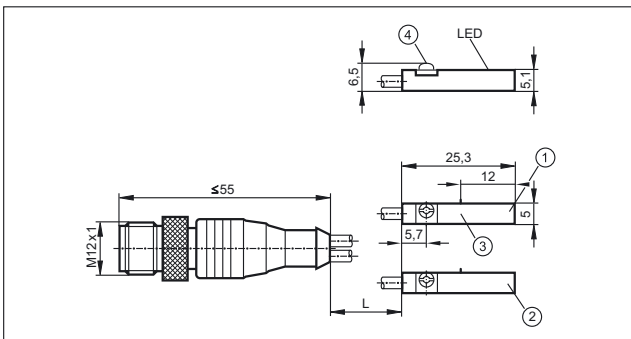

1: sensor 1, 2: sensor 2, 3: sensing face, 4: Fastening clamp

18

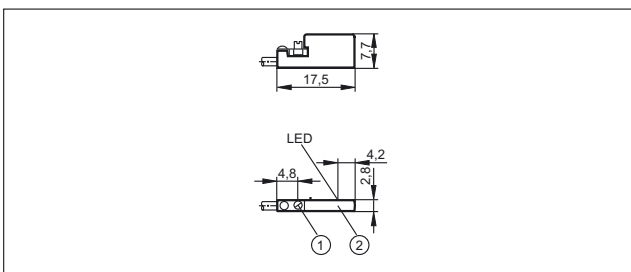

1: Fastening clamp, 2: sensing face

19

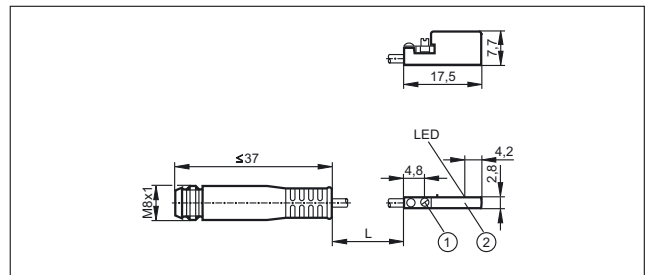

1: Fastening clamp, 2: sensing face

20

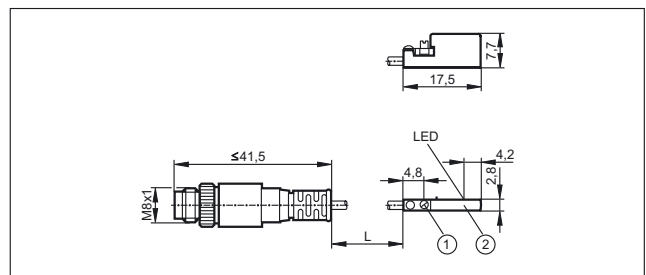

1: Fastening clamp, 2: sensing face

21

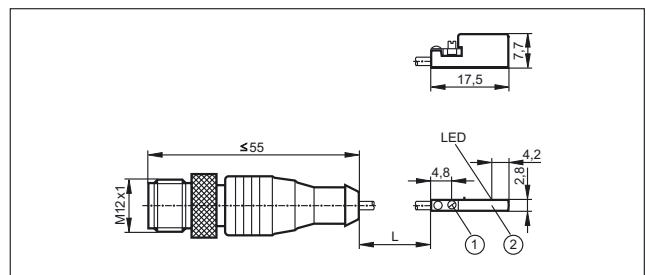

1: Fastening clamp, 2: sensing face

22

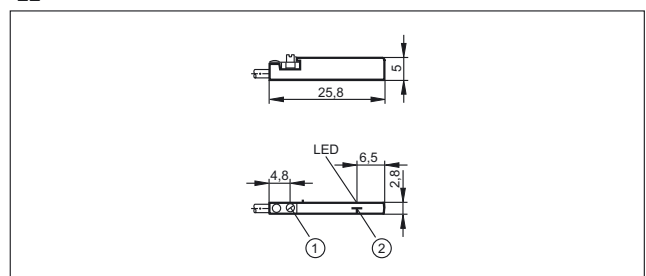

1: Fastening clamp, 2: sensing face

23

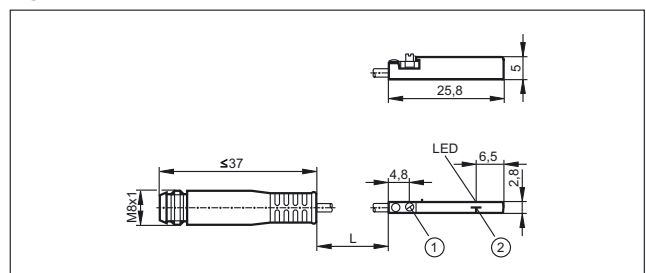

1: Fastening clamp, 2: sensing face

Scale drawings / drawing no. – CAD download: www.ifm.com

24

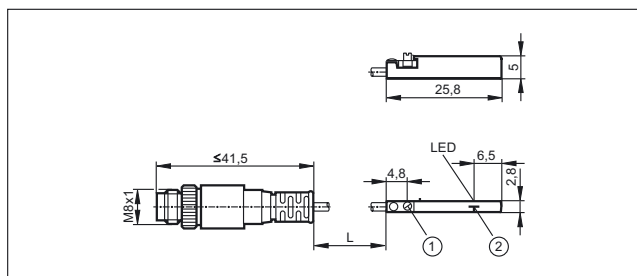

1: Fastening clamp, 2: sensing face

27

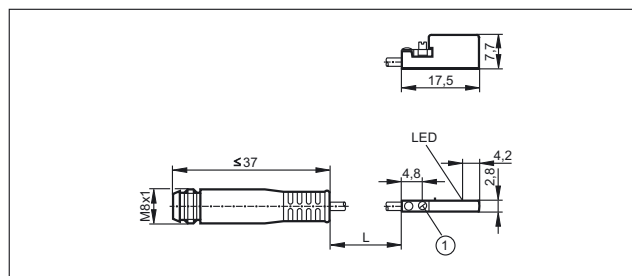

1: Fastening clamp

25

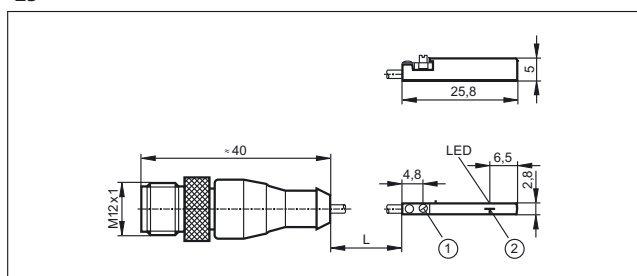

1: Fastening clamp, 2: sensing face

28

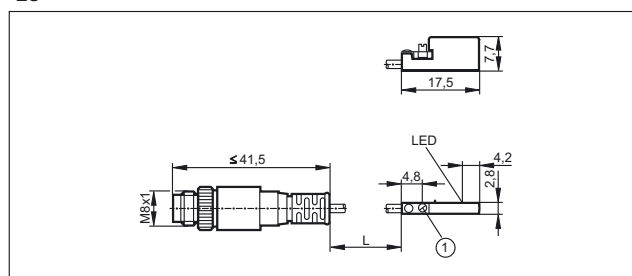

1: Fastening clamp

26

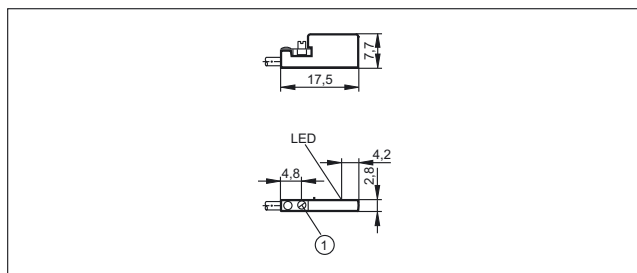

1: Fastening clamp



- Photoelectric sensors for general industrial applications
- Versions for use in hygienic and wet areas
- High-power for long ranges and accurate background suppression
- Easy alignment with visible red light
- Extensive range of mounting accessories

Photoelectric sensors

Compared to inductive, magnetic or capacitive sensors photoelectric sensors have a much higher sensing range and are used for the detection of products over longer distances, but will be more susceptible to the environment. The most important consideration when selecting all photoelectric sensors is contrast.

Through-beam sensors

A through-beam sensor has the longest range of all. The system consists of two separate components: a transmitter and a receiver. The beam is broken by the object resulting in the highest contrast and the highest power (low light loss, high excess gain). Adverse effects in the applications, such as dust in the air, dirt on the lenses, steam or mist do not immediately interfere with the system, so through-beam sensors will always be the most reliable.

Retro-reflective sensors

For a retro-reflective sensor the transmitter and receiver are incorporated into one housing and a prismatic reflector returns the transmitted light to the receiver. The resulting contrast level is high, but light losses mean distances less than for through-beam, but can still be quite considerable. The size and quality of the reflector greatly influences the performance of the sensor.

Diffuse reflection sensors

A diffuse reflection sensor is used for the direct detection of objects. Transmitter and receiver are incorporated into one housing. The transmitter emits light which is reflected by the object to be detected and seen by the receiver.

This system evaluates the reflected light by an object, so the contrast between object present and no object present is greatly dependant on the installation. This results in much lower sensing ranges and greatly increased influence of the object surface, colour, shape, etc.

Diffuse reflection sensors with background suppression

These sensors are specifically designed to check the angle of light reflection to determine if it is from the object in the foreground, or from the background behind it. Modern electronic receiver chips can give excellent results.

Application sensors

Photoelectric sensors are normally fitted far from contamination. But if this is unavoidable in, say, a food environment, where all equipment must be cleaned, ifm has developed special versions able to withstand the harshest washdown and most aggressive cleaning agents.



The reflector reflects the light beam: For a retro-reflective sensor transmitter and receiver are integrated into one housing.







Artificial eyes: Photoelectric sensors are used to detect positions in automation technology.



System overview	Page
Cylindrical OF housing (M12) BasicLine	203 - 204
Cylindrical housing JA (M12)	204
Cylindrical housing OG (M18) BasicLine	204 - 207
Cylindrical housing OG (M18) PerformanceLine	207 - 208
Cylindrical housing OG (M18) WetLine for hygienic and wet areas	209 - 210
Cylindrical housing OG (M18) BasicLine with lateral sensing face	210 - 211
Rectangular housing OG (M18)	211 - 213
OG series (M18) WetLine with rectangular housing for hygienic and wet areas	213
Cylindrical housing OI (M30)	214
Rectangular housing OH BasicLine	214 - 216
Rectangular housing O7 BasicLine	216 - 217
Rectangular housing OJ BasicLine, lateral sensing face	218
Rectangular housing OJ PerformanceLine, lateral sensing face	218 - 220
Rectangular housing OJ PerformanceLine, front sensing face	220 - 221
Rectangular plastic housing in O6 design	222 - 225
Rectangular housing O6 PerformanceLine, WetLine for hygienic and wet areas	226 - 230
Rectangular housing O5 BasicLine	230 - 231
Rectangular housing O5 PerformanceLine	231 - 232
Rectangular housing O5 PerformanceLine with ATEX approval 3D	232
Rectangular housing OL BasicLine	233
Rectangular housing O4 BasicLine	233 - 234
Rectangular housing O4 PerformanceLine	234 - 235
Prismatic reflectors, reflective tape and fixing components	235 - 236
Accessories OF design (M12)	236 - 237
Accessories OG design (M18)	237
Accessories OI design (M30)	237 - 238
Accessories OH housing	238
Accessories O7 housing	238 - 239
Accessories OJ housing	239 - 240
Accessories for O6 design	240
Accessories O5 housing	240 - 241
Accessories OL housing	241 - 242

System overview	Page
Accessories O4 housing	242 - 243
Accessories for system components	243 - 244
Wiring diagrams	244 - 246
Scale drawings / drawing no. – CAD download: www.ifm.com	246 - 258

Cylindrical OF housing (M12) BasicLine

Type	Operating principle	Range	Type of light	Spot Ø at max. range [mm]	Output H = light-on D = dark-on	Wiring diagr. no.	Draw- ing no.	Order no.
Through-beam sensor · Cable 2 m · 10...36 DC · metal · IP67								
	Transmitter	4 m	Infrared	700	–	1	1	OF5018
	Receiver	4 m	Infrared	–	H/D PNP	32	1	OF5019
Through-beam sensor · M12 connector · 10...36 DC · metal · IP65 · Connector groups 8, 10, 18, 20, 120, 124, 126, 128, 157								
	Transmitter	4 m	Infrared	700	–	2	2	OF5021
	Receiver	4 m	Infrared	–	H/D PNP	33	3	OF5022
Retro-reflective sensor · Cable 2 m · 10...36 DC · metal · IP67								
	Retro-reflective sensor	0.05...2 m	Infrared	140	H/D PNP	32	1	OF5014
	Polarisation filter	0.2...0.8 m	Red	70	H/D PNP	32	1	OF5024
	Retro-reflective sensor	0.05...2 m	Infrared	140	H/D NPN	34	1	OF5050
Retro-reflective sensor · M12 connector · 10...36 DC · metal · IP65 · Connector groups 8, 10, 18, 20, 120, 124, 126, 128, 157								
	Retro-reflective sensor	0.05...2 m	Infrared	140	H/D PNP	33	3	OF5016
	Polarisation filter	0.2...0.8 m	Red	70	H/D PNP	33	3	OF5025
	Retro-reflective sensor	0.05...2 m	Infrared	140	H/D NPN	35	3	OF5051
	Polarisation filter	0.2...0.8 m	Red	70	H/D NPN	35	3	OF5062
Diffuse reflection sensor · Cable 2 m · 10...36 DC · metal · IP67								
	Diffuse reflection sensor	1...200 mm	Infrared	92	H/D PNP	32	1	OF5010
	Diffuse reflection sensor	1...200 mm	Infrared	92	H/D NPN	36	1	OF5048

Position sensors

Type	Operating principle	Range	Type of light	Spot Ø at max. range [mm]	Output H = light-on D = dark-on	Wiring diagr. no.	Draw- ing no.	Order no.
------	---------------------	-------	---------------	---------------------------	---------------------------------------	-------------------------	---------------------	--------------

Diffuse reflection sensor · Cable 2 m · 10...36 DC · metal · IP67

	Diffuse reflection sensor	1...400 mm	Infrared	185	H/D PNP	32	1	OF5026
---	---------------------------	------------	----------	-----	---------	----	---	--------

Diffuse reflection sensor · Cable 6 m · 10...36 DC · high-grade stainless steel · IP67

	Diffuse reflection sensor	1...200 mm	Infrared	92	H/D PNP	32	1	OF5032
---	---------------------------	------------	----------	----	---------	----	---	--------

Diffuse reflection sensor · M12 connector · 10...36 DC · metal · IP65 · Connector groups 8, 10, 18, 20, 120, 124, 126, 128, 157

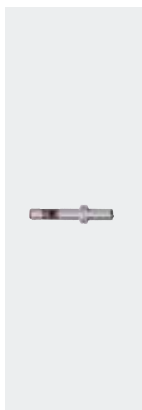
	Diffuse reflection sensor	1...200 mm	Infrared	92	H/D PNP	33	3	OF5012
	Diffuse reflection sensor	1...400 mm	Infrared	185	H/D PNP	33	3	OF5027
	Diffuse reflection sensor	1...200 mm	Infrared	92	H/D NPN	37	3	OF5049
	Diffuse reflection sensor	1...400 mm	Infrared	185	H/D NPN	37	3	OF5060

Cylindrical housing JA (M12)

Type	Dimensions [mm]	Sensing range [mm]	Material	U _b [V]	Protection	f [Hz]	I _{load} [mA]	Draw- ing no.	Order no.
------	--------------------	--------------------------	----------	-----------------------	------------	-----------	---------------------------	---------------------	--------------

M12 connector · Output function · DC PNP · Wiring diagram no. 3 · Connector groups 120, 124, 126, 128, 157

	M12 / L = 63	50 f	High-grade st. steel	10...30	IP 68	1600	100	4	JAC201
	M12 / L = 63	50 f	High-grade st. steel	10...30	IP 68 / IP 69K	1600	100	4	JAT201







f = flush / nf = non flush

Cylindrical housing OG (M18) BasicLine





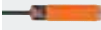

Type	Operating principle	Range	Type of light	Spot Ø at max. range [mm]	Output H = light-on D = dark-on	Wiring diagr. no.	Draw- ing no.	Order no.
------	---------------------	-------	---------------	---------------------------	---------------------------------------	-------------------------	---------------------	--------------





Through-beam sensor · M12 connector · 10...30 DC · plastics · IP67 · Connector groups 8, 10, 18, 20, 120, 124, 126, 128, 157

	Transmitter	8 m	Red	600	–	2	5	OGS100
---	-------------	-----	-----	-----	---	---	---	--------

Type	Operating principle	Range	Type of light	Spot Ø at max. range [mm]	Output H = light-on D = dark-on	Wiring diagr. no.	Draw- ing no.	Order no.
Through-beam sensor · M12 connector · 10...30 DC · plastics · IP67 · Connector groups 8, 10, 11, 18, 20, 120, 124, 126, 128, 130, 157, 158								
	Receiver	8 m	Red	–	D PNP	4	5	OGE100
	Receiver	8 m	Red	–	H PNP	5	5	OGE101
Through-beam sensor · M12 connector · 10...30 DC · plastics · IP67 · Connector groups 8, 10, 18, 20, 120, 124, 126, 128, 157								
	Receiver	8 m	Red	–	D NPN	6	5	OGE102
	Receiver	8 m	Red	–	H NPN	6	5	OGE103
Through-beam sensor · M12 connector · 10...36 DC · high-grade stainless steel · IP67 · Connector groups 8, 10, 18, 20, 120, 124, 126, 128, 157								
	Transmitter	20 m	Red	800	–	2	6	OGS200
Through-beam sensor · M12 connector · 10...36 DC · high-grade stainless steel · IP67 · Connector groups 8, 10, 11, 18, 20, 120, 124, 126, 128, 130, 157, 158								
	Receiver	20 m	Red	–	D PNP	4	6	OGE200
	Receiver	20 m	Red	–	H PNP	5	6	OGE201
Through-beam sensor · Cable 2 m · 20...250 AC/DC (47...63 Hz AC) · plastics · IP67								
	Transmitter	15 m	Infrared	2000	–	7	7	OG0028
	Receiver	15 m	Infrared	–	H AC/DC	8	7	OG0029*
	Receiver	15 m	Infrared	–	D AC/DC	8	7	OG0038*
Through-beam sensor · 1/2" connector · 20...250 AC/DC (47...63 Hz AC) · plastics · IP67 · Connector group 29								
	Transmitter	15 m	Infrared	2000	–	9	8	OG0030
	Receiver	15 m	Infrared	–	H AC/DC	10	8	OG0031*
	Receiver	15 m	Infrared	–	D AC/DC	10	8	OG0039*

Position sensors

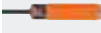

Type	Operating principle	Range	Type of light	Spot Ø at max. range [mm]	Output H = light-on D = dark-on	Wiring diagr. no.	Draw- ing no.	Order no.
Retro-reflective sensor · M12 connector · 10...30 DC · plastics · IP67 · Connector groups 8, 10, 11, 18, 20, 120, 124, 126, 128, 130, 157, 158								
	Polarisation filter	0.05...2.5 m	Red	200	D PNP	4	5	OGP100
	Polarisation filter	0.05...2.5 m	Red	200	H PNP	5	5	OGP101
Retro-reflective sensor · M12 connector · 10...30 DC · plastics · IP67 · Connector groups 8, 10, 18, 20, 120, 124, 126, 128, 157								
	Polarisation filter	0.05...2.5 m	Red	200	D NPN	6	5	OGP102
	Polarisation filter	0.05...2.5 m	Red	200	H NPN	6	5	OGP103
Retro-reflective sensor · M12 connector · 10...36 DC · high-grade stainless steel · IP67 · Connector groups 8, 10, 11, 18, 20, 120, 124, 126, 128, 130, 157, 158								
	Polarisation filter	0.03...4 m	Red	160	D PNP	4	6	OGP200
	Polarisation filter	0.03...4 m	Red	160	H PNP	5	6	OGP201
Retro-reflective sensor · Cable 2 m · 20...250 AC/DC (47...63 Hz AC) · plastics · IP67								
	Polarisation filter	3 m	Red	262	H AC/DC	8	7	OG0043*
	Polarisation filter	3 m	Red	262	D AC/DC	8	7	OG0032*
Retro-reflective sensor · 1/2" connector · 20...250 AC/DC (47...63 Hz AC) · plastics · IP67 · Connector group 29								
	Polarisation filter	3 m	Red	262	H AC/DC	10	8	OG0044*
	Polarisation filter	3 m	Red	262	D AC/DC	10	8	OG0033*
Diffuse reflection sensor · M12 connector · 10...30 DC · plastics · IP65 · Connector groups 8, 10, 11, 18, 20, 120, 124, 126, 128, 130, 157, 158								
	Diffuse reflection sensor	10...400 mm	Red	25	H PNP	4	9	OGT100
	Diffuse reflection sensor	10...400 mm	Red	25	D PNP	4	9	OGT101
Diffuse reflection sensor · M12 connector · 10...30 DC · plastics · IP65 · Connector groups 8, 10, 18, 20, 120, 124, 126, 128, 157								
	Diffuse reflection sensor	10...400 mm	Red	25	H NPN	6	9	OGT102

Type	Operating principle	Range	Type of light	Spot Ø at max. range [mm]	Output H = light-on D = dark-on	Wiring diagr. no.	Draw- ing no.	Order no.
Diffuse reflection sensor · M12 connector · 10...30 DC · plastics · IP65 · Connector groups 8, 10, 18, 20, 120, 124, 126, 128, 157								
	Diffuse reflection sensor	10...400 mm	Red	25	D NPN	6	9	OGT103
Diffuse reflection sensor · M12 connector · 10...36 DC · high-grade stainless steel · IP65 · Connector groups 8, 10, 11, 18, 20, 120, 124, 126, 128, 130, 157, 158								
	Diffuse reflection sensor	2...600 mm	Red	50	H PNP	4	10	OGT200
	Background suppression	15...250 mm	Red	21	H PNP	4	10	OGH200
Diffuse reflection sensor · Cable 2 m · 20...250 AC/DC (47...63 Hz AC) · plastics · IP67								
	Diffuse reflection sensor	1...600 mm	Infrared	< 169	H AC/DC	8	7	OG0034*
	Diffuse reflection sensor	1...600 mm	Infrared	< 169	D AC/DC	8	7	OG0040*
Diffuse reflection sensor · Cable 0.377 m · 20...250 AC/DC (47...63 Hz AC) · plastics · IP67								
	Diffuse reflection sensor	1...600 mm	Infrared	< 169	H AC/DC	8	7	OG0047*
Diffuse reflection sensor · 1/2" connector · 20...250 AC/DC (47...63 Hz AC) · plastics · IP67 · Connector group 29								
	Diffuse reflection sensor	1...600 mm	Infrared	< 169	H AC/DC	10	8	OG0035*
	Diffuse reflection sensor	1...600 mm	Infrared	< 169	D AC/DC	10	8	OG0041*











*** Note for AC and AC/DC units**

Miniature fuse to IEC60127-2 sheet 1, ≤ 2 A (fast acting) Recommendation: check the unit for reliable function after a short circuit.







Cylindrical housing OG (M18) PerformanceLine

Type	Operating principle	Range	Type of light	Spot Ø at max. range [mm]	Output H = light-on D = dark-on	Wiring diagr. no.	Draw- ing no.	Order no.
Through-beam sensor · Cable 2 m · 10...36 DC · high-grade stainless steel · IP67								
	Transmitter	25 m	Red	1000	–	1	11	OGS501
	Receiver	25 m	Red	–	H/D PNP	11	12	OGE502

Position sensors

Type	Operating principle	Range	Type of light	Spot Ø at max. range [mm]	Output H = light-on D = dark-on	Wiring diagr. no.	Draw- ing no.	Order no.
Through-beam sensor · M12 connector · 10...36 DC · high-grade stainless steel · IP67 · Connector groups 8, 10, 18, 20, 120, 124, 126, 128, 157								
	Transmitter	25 m	Red	1000	–	2	13	OGS500
Through-beam sensor · M12 connector · 10...36 DC · high-grade stainless steel · IP67 · Connector groups 8, 10, 11, 18, 20, 120, 124, 126, 128, 130, 157, 158								
	Receiver	25 m	Red	–	H/D PNP	4	14	OGE500
Retro-reflective sensor · Cable 2 m · 10...36 DC · high-grade stainless steel · IP67								
	Polarisation filter	0.03...5 m	Red	200	H/D PNP	11	12	OGP502
Retro-reflective sensor · M12 connector · 10...36 DC · high-grade stainless steel · IP67 · Connector groups 8, 10, 11, 18, 20, 120, 124, 126, 128, 130, 157, 158								
	Polarisation filter	0.03...5 m	Red	200	H/D PNP	4	14	OGP500
Retro-reflective sensor · M12 connector · 10...36 DC · high-grade stainless steel · IP67 · Connector groups 8, 10, 18, 20, 120, 124, 126, 128, 157								
	Polarisation filter	0.03...5 m	Red	200	H/D NPN	6	14	OGP503
Diffuse reflection sensor · Cable 2 m · 10...36 DC · high-grade stainless steel · IP67								
	Background suppression	15...300 mm	Red	25	H/D PNP	11	12	OGH501
Diffuse reflection sensor · M12 connector · 10...36 DC · high-grade stainless steel · IP67 · Connector groups 8, 10, 11, 18, 20, 120, 124, 126, 128, 130, 157, 158								
	Diffuse reflection sensor	2...800 mm	Red	66	H/D PNP	4	14	OGT500
	Background suppression	15...300 mm	Red	25	H/D PNP	4	14	OGH500
Diffuse reflection sensor · M12 connector · 10...36 DC · high-grade stainless steel · IP67 · Connector groups 8, 10, 18, 20, 120, 124, 126, 128, 157								
	Background suppression	15...300 mm	Red	25	H/D NPN	6	14	OGH504
	Background suppression	15...300 mm	Red	25	H/D NPN	6	14	OGH502

Cylindrical housing OG (M18) WetLine for hygienic and wet areas

Type	Operating principle	Range	Type of light	Spot Ø at max. range [mm]	Output H = light-on D = dark-on	Wiring diagr. no.	Draw- ing no.	Order no.
Through-beam sensor · Cable 6 m · 10...36 DC · high-grade stainless steel · IP67 / IP68 / IP69K								
	Transmitter	20 m	Red	800	–	1	15	OGS301
	Receiver	20 m	Red	–	D PNP	11	15	OGE302
	Receiver	20 m	Red	–	H PNP	11	15	OGE303
Through-beam sensor · M12 connector · 10...36 DC · high-grade stainless steel · IP67 / IP68 / IP69K · Connector groups 120, 124, 126								
	Transmitter	20 m	Red	800	–	2	6	OGS300
Through-beam sensor · M12 connector · 10...36 DC · high-grade stainless steel · IP67 / IP68 / IP69K · Connector groups 120, 124, 126, 130								
	Receiver	20 m	Red	–	D PNP	4	6	OGE300
	Receiver	20 m	Red	–	H PNP	5	6	OGE301
Retro-reflective sensor · Cable 6 m · 10...36 DC · high-grade stainless steel · IP67 / IP68 / IP69K								
	Polarisation filter	0.03...4 m	Red	160	D PNP	11	15	OGP302
	Polarisation filter	0.03...4 m	Red	160	H PNP	11	15	OGP303
Retro-reflective sensor · M12 connector · 10...36 DC · high-grade stainless steel · IP67 / IP68 / IP69K · Connector groups 120, 124, 126, 130								
	Polarisation filter	0.03...4 m	Red	160	D PNP	4	6	OGP300
	Polarisation filter	0.03...4 m	Red	160	H PNP	5	6	OGP301
Diffuse reflection sensor · Cable 6 m · 10...36 DC · high-grade stainless steel · IP67 / IP68 / IP69K								
	Background suppression	100 mm	Red	9	H PNP	11	16	OGH306
	Background suppression	100 mm	Red	9	D PNP	11	16	OGH307

Position sensors

Type	Operating principle	Range	Type of light	Spot Ø at max. range [mm]	Output H = light-on D = dark-on	Wiring diagr. no.	Draw- ing no.	Order no.
------	---------------------	-------	---------------	---------------------------	---------------------------------------	-------------------------	---------------------	--------------

Diffuse reflection sensor · Cable 6 m · 10...36 DC · high-grade stainless steel · IP67 / IP68 / IP69K

	Background suppression	200 mm	Red	17	H PNP	11	16	OGH308
	Background suppression	200 mm	Red	17	D PNP	11	16	OGH309
	Background suppression	300 mm	Red	25	H PNP	11	16	OGH310
	Background suppression	300 mm	Red	25	D PNP	11	16	OGH311

Diffuse reflection sensor · M12 connector · 10...36 DC · high-grade stainless steel · IP67 / IP68 / IP69K · Connector groups 120, 124, 126, 130

	Background suppression	100 mm	Red	9	H PNP	4	17	OGH300
	Background suppression	100 mm	Red	9	D PNP	4	17	OGH301
	Background suppression	200 mm	Red	17	H PNP	4	17	OGH302
	Background suppression	200 mm	Red	17	D PNP	4	17	OGH303
	Background suppression	300 mm	Red	25	H PNP	4	17	OGH304
	Background suppression	300 mm	Red	25	D PNP	4	17	OGH305

Cylindrical housing OG (M18) BasicLine with lateral sensing face

Type	Operating principle	Range	Type of light	Spot Ø at max. range [mm]	Output H = light-on D = dark-on	Wiring diagr. no.	Draw- ing no.	Order no.
------	---------------------	-------	---------------	---------------------------	---------------------------------------	-------------------------	---------------------	--------------

Through-beam sensor · M12 connector · 10...30 DC · high-grade stainless steel · IP68 · Connector groups 8, 10, 18, 20, 120, 124, 126, 128, 157

	Transmitter	9 m	Red	< 3000	–	2	18	OG5129
	Receiver	9 m	Red	–	H PNP	12	18	OG5127
	Receiver	9 m	Red	–	D PNP	13	18	OG5128

Type	Operating principle	Range	Type of light	Spot Ø at max. range [mm]	Output H = light-on D = dark-on	Wiring diagr. no.	Draw- ing no.	Order no.
------	---------------------	-------	---------------	---------------------------	---------------------------------------	-------------------------	---------------------	--------------

Retro-reflective sensor · M12 connector · 10...30 DC · high-grade stainless steel · IP68 · Connector groups 8, 10, 18, 20, 120, 124, 126, 128, 157

	Polarisation filter	3 m	Red	< 96	H PNP	12	18	OG5125
	Polarisation filter	3 m	Red	< 96	D PNP	13	18	OG5126

Diffuse reflection sensor · M12 connector · 10...30 DC · high-grade stainless steel · IP68 · Connector groups 8, 10, 18, 20, 120, 124, 126, 128, 157

	Background suppression	100 mm	Red	< 16	H PNP	12	19	OG5123
---	------------------------	--------	-----	------	-------	----	----	--------

Diffuse reflection sensor · M12 connector · 10...30 DC · high-grade stainless steel · IP68 · Connector groups 8, 10, 11, 18, 20, 120, 124, 126, 128, 130, 157, 158

	Background suppression	200 mm	Red	< 28	H PNP	12	19	OG5124
---	------------------------	--------	-----	------	-------	----	----	--------

Rectangular housing OG (M18)

Type	Operating principle	Range	Type of light	Spot Ø at max. range [mm]	Output H = light-on D = dark-on	Wiring diagr. no.	Draw- ing no.	Order no.
------	---------------------	-------	---------------	---------------------------	---------------------------------------	-------------------------	---------------------	--------------

Through-beam sensor · M12 connector · 10...30 DC · metal · IP67 · Connector groups 8, 10, 18, 20, 120, 124, 126, 128, 157

	Transmitter	20 m	Red	800	–	2	20	OGS280
	Receiver	20 m	Red	–	D NPN	14	20	OGE282

Through-beam sensor · M12 connector · 10...30 DC · metal · IP67 · Connector groups 8, 10, 11, 18, 20, 120, 124, 126, 128, 130, 157, 158

	Receiver	20 m	Red	–	D PNP	15	20	OGE280
	Receiver	20 m	Red	–	H PNP	5	20	OGE281



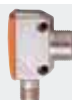



Through-beam sensor · 1/2" connector · 20...250 AC (47...60 Hz) · metal · IP67 · Connector group 29

	Transmitter	20 m	Red	800	–	16	21	OGS080*
---	-------------	------	-----	-----	---	----	----	---------

Through-beam sensor · 1/2" connector · 20...250 AC (47...63 Hz) · metal · IP67 · Connector group 29

	Receiver	20 m	Red	–	D AC	17	21	OGE080*
---	----------	------	-----	---	------	----	----	---------

Position sensors

Type	Operating principle	Range	Type of light	Spot Ø at max. range [mm]	Output H = light-on D = dark-on	Wiring diagr. no.	Draw- ing no.	Order no.
Through-beam sensor · 1/2" connector · 20...250 AC (47...63 Hz) · metal · IP67 · Connector group 29								
	Receiver	20 m	Red	–	H AC	17	21	OGE081*
Retro-reflective sensor · M12 connector · 10...30 DC · metal · IP67 · Connector groups 8, 10, 11, 18, 20, 120, 124, 126, 128, 130, 157, 158								
	Polarisation filter	0.1...4 m	Red	160	D PNP	15	20	OGP280
	Polarisation filter	0.1...4 m	Red	160	H PNP	5	20	OGP281
Retro-reflective sensor · M12 connector · 10...30 DC · metal · IP67 · Connector groups 8, 10, 18, 20, 120, 124, 126, 128, 157								
	Polarisation filter	0.1...4 m	Red	160	D NPN	14	20	OGP282
	Polarisation filter	0.1...4 m	Red	160	H NPN	18	20	OGP283
Retro-reflective sensor · 1/2" connector · 20...250 AC (47...63 Hz) · metal · IP67 · Connector group 29								
	Polarisation filter	4 m	Red	160	D AC	17	21	OGP080*
	Polarisation filter	4 m	Red	160	H AC	17	21	OGP081*
Diffuse reflection sensor · M12 connector · 10...30 DC · metal · IP67 · Connector groups 8, 10, 11, 18, 20, 120, 124, 126, 128, 130, 157, 158								
	Background suppression	100 mm	Red	7	H PNP	5	20	OGH280
	Background suppression	200 mm	Red	13	H PNP	5	20	OGH281
	Background suppression	15...200 mm	Red	13	H/D PNP	4	22	OGH580
Diffuse reflection sensor · M12 connector · 10...30 DC · metal · IP67 · Connector groups 8, 10, 18, 20, 120, 124, 126, 128, 157								
	Background suppression	100 mm	Red	7	H NPN	18	20	OGH282
	Background suppression	200 mm	Red	13	H NPN	18	20	OGH283
	Background suppression	15...200 mm	Red	13	H/D NPN	6	22	OGH581

Type	Operating principle	Range	Type of light	Spot Ø at max. range [mm]	Output H = light-on D = dark-on	Wiring diagr. no.	Draw- ing no.	Order no.
------	---------------------	-------	---------------	---------------------------	---------------------------------------	-------------------------	---------------------	--------------

Diffuse reflection sensor · 1/2" connector · 20...250 AC (47...63 Hz) · metal · IP67 · Connector group 29

	Background suppression	100 mm	Red	11	H AC	17	21	OGH080*
	Background suppression	100 mm	Red	11	D AC	17	21	OGH081*

* Note for AC and AC/DC units

Miniature fuse to IEC60127-2 sheet 1, ≤ 2 A (fast acting) Recommendation: check the unit for reliable function after a short circuit.

OG series (M18) WetLine with rectangular housing for hygienic and wet areas

Type	Operating principle	Range	Type of light	Spot Ø at max. range [mm]	Output H = light-on D = dark-on	Wiring diagr. no.	Draw- ing no.	Order no.
------	---------------------	-------	---------------	---------------------------	---------------------------------------	-------------------------	---------------------	--------------

Through-beam sensor · M12 connector · 10...30 DC · metal · IP67 / IP68 / IP69K · Connector groups 8, 10, 18, 20, 120, 124, 126, 128, 157

	Transmitter	15 m	Red	800	–	2	23	OGS380
---	-------------	------	-----	-----	---	---	----	--------

Through-beam sensor · M12 connector · 10...30 DC · metal · IP67 / IP68 / IP69K · Connector groups 8, 10, 11, 18, 20, 120, 124, 126, 128, 130, 157, 158

	Receiver	15 m	Red	–	D PNP	15	23	OGE380
	Receiver	15 m	Red	–	H PNP	5	23	OGE381
	Receiver	15 m	Red	–	D NPN	14	23	OGE382

Diffuse reflection sensor · M12 connector · 10...30 DC · metal · IP67 / IP68 / IP69K · Connector groups 8, 10, 11, 18, 20, 120, 124, 126, 128, 130, 157, 158

	Background suppression	100 mm	Red	7	H PNP	5	23	OGH380
	Background suppression	200 mm	Red	13	H PNP	5	23	OGH381
	Background suppression	100 mm	Red	7	H NPN	18	23	OGH382
	Background suppression	200 mm	Red	13	H NPN	18	23	OGH383

Cylindrical housing OI (M30)

Type	Operating principle	Range	Type of light	Spot Ø at max. range [mm]	Output H = light-on D = dark-on	Wiring diagr. no.	Draw- ing no.	Order no.
------	---------------------	-------	---------------	---------------------------	---------------------------------------	-------------------------	---------------------	--------------

Diffuse reflection sensor · M12 connector · 10...30 DC · metal · IP67 · Connector groups 8, 10, 11, 18, 20, 120, 124, 126, 128, 130, 157, 158

	Background suppression	600 mm	Red	30	H PNP	5	24	OIH280
---	------------------------	--------	-----	----	-------	---	----	--------

Diffuse reflection sensor · M12 connector · 10...30 DC · metal · IP67 · Connector groups 8, 10, 18, 20, 120, 124, 126, 128, 157

	Background suppression	600 mm	Red	30	H NPN	18	24	OIH282
---	------------------------	--------	-----	----	-------	----	----	--------

Diffuse reflection sensor · M12 connector · 10...30 DC · metal · IP67 · Connector groups 8, 10, 11, 18, 20, 120, 124, 126, 128, 130, 157, 158

	Background suppression	50...800 mm	Red	55	H PNP	5	25	OIH580
---	------------------------	-------------	-----	----	-------	---	----	--------

Diffuse reflection sensor · M12 connector · 10...30 DC · metal · IP67 · Connector groups 8, 10, 18, 20, 120, 124, 126, 128, 157

	Background suppression	50...800 mm	Red	55	H NPN	18	25	OIH582
---	------------------------	-------------	-----	----	-------	----	----	--------

Retro-reflective sensor · M12 connector · 10...30 DC · metal · IP67 · Connector groups 8, 10, 11, 18, 20, 120, 124, 126, 128, 130, 157, 158













	Polarisation filter	0.1...15 m	Red	100 x 130	D PNP	15	26	OIP280
	Polarisation filter	0.1...15 m	Red	100 x 130	H PNP	5	26	OIP281
	Polarisation filter	0.1...15 m	Red	100 x 130	D NPN	14	26	OIP282
	Polarisation filter	0.1...15 m	Red	100 x 130	H NPN	18	26	OIP283

Rectangular housing OH BasicLine

Type	Operating principle	Range	Type of light	Spot Ø at max. range [mm]	Output H = light-on D = dark-on	Wiring diagr. no.	Draw- ing no.	Order no.
------	---------------------	-------	---------------	---------------------------	---------------------------------------	-------------------------	---------------------	--------------

Through-beam sensor · Cable 2 m · 10...30 DC · plastics · IP67

	Transmitter	1.2 m	Red	10	–	1	27	OH5001
	Receiver	1.2 m	Red	–	D PNP	19	27	OH5002

Type	Operating principle	Range	Type of light	Spot Ø at max. range [mm]	Output H = light-on D = dark-on	Wiring diagr. no.	Draw- ing no.	Order no.
Through-beam sensor · Cable 0.2 m · with M8 connector · 10...30 DC · plastics · IP67 · Connector groups 1, 3, 72, 78, 120								
	Transmitter	1.2 m	Red	10	–	2	27	OH5020
Through-beam sensor · Cable 0.2 m · with M8 connector · 10...30 DC · plastics · IP67 · Connector groups 1, 2, 3, 72, 78, 120, 122								
	Receiver	1.2 m	Red	–	D PNP	15	27	OH5015
Through-beam sensor · Cable 0.2 m · with M8 connector · 10...30 DC · plastics · IP67 · Connector groups 4, 5, 74, 80, 124								
	Transmitter	1.2 m	Red	10	–	2	27	OH5012
	Receiver	1.2 m	Red	–	D PNP	15	27	OH5003
Retro-reflective sensor · Cable 2 m · 10...30 DC · plastics · IP67								
	Polarisation filter	0.8 m	Red	10	D PNP	19	28	OH5010
Retro-reflective sensor · Cable 0.2 m · with M8 connector · 10...30 DC · plastics · IP67 · Connector groups 1, 2, 3, 72, 78, 120, 122								
	Polarisation filter	0.8 m	Red	10	D PNP	15	28	OH5019
Retro-reflective sensor · Cable 0.2 m · with M8 connector · 10...30 DC · plastics · IP67 · Connector groups 4, 5, 74, 80, 124								
	Polarisation filter	0.8 m	Red	10	D PNP	15	28	OH5011
Diffuse reflection sensor · Cable 2 m · 10...30 DC · plastics · IP67								
	Background suppression	1...15 mm	Red	2.5	H PNP	20	29	OH5008
	Background suppression	1...30 mm	Red	4.5	H PNP	20	29	OH5006
	Diffuse reflection sensor	2...50 mm	Red	3.5	H PNP	20	29	OH5004
Diffuse reflection sensor · Cable 0.2 m · with M8 connector · 10...30 DC · plastics · IP67 · Connector groups 1, 2, 3, 72, 78, 120, 122								
	Diffuse reflection sensor	2...50 mm	Red	3.5	H PNP	5	29	OH5016
	Background suppression	1...15 mm	Red	2.5	H PNP	5	29	OH5018

Position sensors

Type	Operating principle	Range	Type of light	Spot Ø at max. range [mm]	Output H = light-on D = dark-on	Wiring diagr. no.	Draw- ing no.	Order no.
------	---------------------	-------	---------------	---------------------------	---------------------------------------	-------------------------	---------------------	--------------

Diffuse reflection sensor · Cable 0.2 m · with M8 connector · 10...30 DC · plastics · IP67 · Connector groups 1, 2, 3, 72, 78, 120, 122



Background suppression	1...30 mm	Red	4.5	H PNP	5	29	OH5017
------------------------	-----------	-----	-----	-------	---	----	---------------

Diffuse reflection sensor · Cable 0.2 m · with M8 connector · 10...30 DC · plastics · IP67 · Connector groups 4, 5, 74, 80, 124

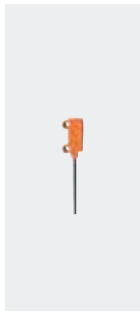

Diffuse reflection sensor	2...50 mm	Red	3.5	H PNP	5	29	OH5005
---------------------------	-----------	-----	-----	-------	---	----	---------------

Background suppression	1...15 mm	Red	2.5	H PNP	5	29	OH5009
------------------------	-----------	-----	-----	-------	---	----	---------------

Background suppression	1...30 mm	Red	4.5	H PNP	5	29	OH5007
------------------------	-----------	-----	-----	-------	---	----	---------------

Rectangular housing O7 BasicLine

Type	Operating principle	Range	Type of light	Spot Ø at max. range [mm]	Output H = light-on D = dark-on	Wiring diagr. no.	Draw- ing no.	Order no.
------	---------------------	-------	---------------	---------------------------	---------------------------------------	-------------------------	---------------------	--------------

Through-beam sensor · Cable 0.2 m · with M8 connector · 10...30 DC · plastics · IP65 · Connector groups 1, 3, 72, 78, 120



Transmitter	0...1.5 m	Red	90	–	2	30	O7S200
-------------	-----------	-----	----	---	---	----	---------------

Through-beam sensor · Cable 0.2 m · with M8 connector · 10...30 DC · plastics · IP65 · Connector groups 1, 2, 3, 72, 78, 120, 122



Receiver	0...1.5 m	Red	–	D PNP	15	31	O7E200
----------	-----------	-----	---	-------	----	----	---------------

Receiver	0...1.5 m	Red	–	H PNP	5	31	O7E201
----------	-----------	-----	---	-------	---	----	---------------

Receiver	0...1.5 m	Red	–	D NPN	14	31	O7E202
----------	-----------	-----	---	-------	----	----	---------------

Receiver	0...1.5 m	Red	–	H NPN	18	31	O7E203
----------	-----------	-----	---	-------	----	----	---------------

Retro-reflective sensor · Cable 0.2 m · with M8 connector · 10...30 DC · plastics · IP65 · Connector groups 1, 2, 3, 72, 78, 120, 122

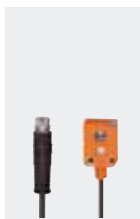

Polarisation filter	0.03...1 m	Red	55	D PNP	15	32	O7P200
---------------------	------------	-----	----	-------	----	----	---------------

Polarisation filter	0.03...1 m	Red	55	H PNP	5	32	O7P201
---------------------	------------	-----	----	-------	---	----	---------------

Polarisation filter	0.03...1 m	Red	55	D NPN	14	32	O7P202
---------------------	------------	-----	----	-------	----	----	---------------

Product selectors and further information can be found at: www.ifm.com

Type	Operating principle	Range	Type of light	Spot Ø at max. range [mm]	Output H = light-on D = dark-on	Wiring diagr. no.	Draw- ing no.	Order no.
------	---------------------	-------	---------------	---------------------------	---------------------------------------	-------------------------	---------------------	--------------

Retro-reflective sensor · Cable 0.2 m · with M8 connector · 10...30 DC · plastics · IP65 · Connector groups 1, 2, 3, 72, 78, 120, 122







Polarisation filter	0.03...1 m	Red	55	H NPN	18	32	O7P203
---------------------	------------	-----	----	-------	----	----	---------------

Diffuse reflection sensor · Cable 0.2 m · with M8 connector · 10...30 DC · plastics · IP65 · Connector groups 1, 2, 3, 72, 78, 120, 122













Background suppression	5...30 mm	Red	2.5	H PNP	5	33	O7H200
Background suppression	5...30 mm	Red	2.5	D PNP	15	33	O7H201
Background suppression	5...30 mm	Red	2.5	H NPN	18	33	O7H206
Background suppression	5...30 mm	Red	2.5	D NPN	14	33	O7H207
Background suppression	5...50 mm	Red	2.5	H PNP	5	33	O7H202
Background suppression	5...50 mm	Red	2.5	H NPN	18	33	O7H208
Background suppression	5...50 mm	Red	2.5	D NPN	14	33	O7H209
Background suppression	5...50 mm	Red	2.5	D PNP	15	33	O7H203
Background suppression	3...100 mm	Red	7	H PNP	5	33	O7H204
Background suppression	3...100 mm	Red	7	D PNP	15	33	O7H205
Background suppression	3...100 mm	Red	7	H NPN	18	33	O7H210
Background suppression	3...100 mm	Red	7	D NPN	14	33	O7H211

Rectangular housing OJ BasicLine, lateral sensing face

Type	Operating principle	Range	Type of light	Spot Ø at max. range [mm]	Output H = light-on D = dark-on	Wiring diagr. no.	Draw- ing no.	Order no.
Through-beam sensor · M8 connector · 10...30 DC · plastics · IP67 · Connector groups 1, 3, 72, 78, 120								
	Transmitter	0...10 m	Red	< 1000	–	2	34	OJ5200
Through-beam sensor · M8 connector · 10...30 DC · plastics · IP67 · Connector groups 1, 2, 3, 72, 78, 120, 122								
	Receiver	10 m	–	–	D PNP	4	34	OJE200
Retro-reflective sensor · M8 connector · 10...30 DC · plastics · IP67 · Connector groups 1, 2, 3, 72, 78, 120, 122								
	Retro-reflective sensor	1.8 m	Red	64	D PNP	4	34	OJR200
	Polarisation filter	1.8 m	Red	64	D PNP	4	34	OJP200
Diffuse reflection sensor · M8 connector · 10...30 DC · plastics · IP67 · Connector groups 1, 2, 3, 72, 78, 120, 122								
	Background suppression	100 mm	Red	< 13	H PNP	4	35	OJH200

Rectangular housing OJ PerformanceLine, lateral sensing face

Type	Operating principle	Range	Type of light	Spot Ø at max. range [mm]	Output H = light-on D = dark-on	Wiring diagr. no.	Draw- ing no.	Order no.
Through-beam sensor · Cable 2 m · 10...30 DC · plastics · IP67								
	Transmitter	10 m	Red	1000	–	1	36	OJ5033
	Receiver	10 m	Red	–	H/D PNP	21	36	OJ5034
Through-beam sensor · M8 connector · 10...30 DC · plastics · IP67 · Connector groups 4, 5, 74, 80, 124								
	Transmitter	10 m	Red	1000	–	2	37	OJ5030
	Receiver	10 m	Red	–	H/D PNP	22	37	OJ5031
	Receiver	10 m	Red	–	H/D NPN	23	37	OJ5032

Type	Operating principle	Range	Type of light	Spot Ø at max. range [mm]	Output H = light-on D = dark-on	Wiring diagr. no.	Draw- ing no.	Order no.
Through-beam sensor · M8 connector · 10...30 DC · plastics · IP67 · Connector groups 4, 5, 74, 80, 124								
	Transmitter	10 m	Red	1000	–	2	38	OJ5130
	Receiver	10 m	Red	–	H/D PNP	22	38	OJ5131
Retro-reflective sensor · Cable 2 m · 10...30 DC · plastics · IP67								
	Polarisation filter	0...2 m	Red	64	H/D PNP	21	36	OJ5028
Retro-reflective sensor · M8 connector · 10...30 DC · plastics · IP67 · Connector groups 4, 5, 74, 80, 124								
	Polarisation filter	0...2 m	Red	64	H/D PNP	22	37	OJ5026
	Polarisation filter	0...2 m	Red	64	H/D NPN	23	37	OJ5027
	Polarisation filter	0...2 m	Red	64	H/D PNP	22	38	OJ5126
Diffuse reflection sensor · Cable 2 m · 10...30 DC · plastics · IP67								
	Diffuse reflection sensor	1...600 mm	Red	60	H/D PNP	21	39	OJ5024
Diffuse reflection sensor · Cable 0.15 m · with M12 connector · 10...30 DC · plastics · IP67 · Connector groups 8, 10, 18, 20, 120, 124, 126, 128, 157								
	Background suppression	15...400 mm	Red	< 18	H/D PNP	22	40	OJ5078
Diffuse reflection sensor · M8 connector · 10...30 DC · plastics · IP67 · Connector groups 4, 5, 74, 80, 124								
	Diffuse reflection sensor	1...600 mm	Red	60	H/D PNP	22	41	OJ5022
	Diffuse reflection sensor	1...600 mm	Red	60	H/D NPN	23	41	OJ5023
	Diffuse reflection sensor	1...1000 mm	Infrared	150	H/D PNP	22	41	OJ5071
	Background suppression	15...400 mm	Red	< 18	H/D PNP	22	42	OJ5048
	Diffuse reflection sensor	1...600 mm	Red	60	H/D PNP	22	43	OJ5122

Position sensors

Type	Operating principle	Range	Type of light	Spot Ø at max. range [mm]	Output H = light-on D = dark-on	Wiring diagr. no.	Draw- ing no.	Order no.
------	---------------------	-------	---------------	---------------------------	---------------------------------------	-------------------------	---------------------	--------------

Diffuse reflection sensor · M8 connector · 10...30 DC · plastics · IP67 · Connector groups 4, 5, 74, 80, 124



Background suppression	15...400 mm	Red	< 18	H/D PNP	22	44	OJ5148
------------------------	-------------	-----	------	---------	----	----	---------------

Rectangular housing OJ PerformanceLine, front sensing face

Type	Operating principle	Range	Type of light	Spot Ø at max. range [mm]	Output H = light-on D = dark-on	Wiring diagr. no.	Draw- ing no.	Order no.
------	---------------------	-------	---------------	---------------------------	---------------------------------------	-------------------------	---------------------	--------------

Through-beam sensor · Cable 2 m · 10...30 DC · plastics · IP67



Transmitter	10 m	Red	1000	–	1	45	OJ5011
-------------	------	-----	------	---	---	----	---------------

Receiver	10 m	Red	–	H/D PNP	21	45	OJ5012
----------	------	-----	---	---------	----	----	---------------

Through-beam sensor · Cable 0.15 m · with M12 connector · 10...30 DC · plastics · IP67 · Connector groups 8, 10, 18, 20, 120, 124, 126, 128, 157

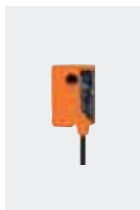

Transmitter	10 m	Red	1000	–	2	45	OJ5065
-------------	------	-----	------	---	---	----	---------------

Receiver	10 m	Red	–	H/D PNP	22	45	OJ5067
----------	------	-----	---	---------	----	----	---------------

Through-beam sensor · M8 connector · 10...30 DC · plastics · IP67 · Connector groups 4, 5, 74, 80, 124



Transmitter	10 m	Red	1000	–	2	46	OJ5008
-------------	------	-----	------	---	---	----	---------------

Receiver	10 m	Red	–	H/D PNP	22	46	OJ5009
----------	------	-----	---	---------	----	----	---------------

Receiver	10 m	Red	–	H/D NPN	23	46	OJ5010
----------	------	-----	---	---------	----	----	---------------









Transmitter	10 m	Red	1000	–	2	47	OJ5108
-------------	------	-----	------	---	---	----	---------------

Receiver	10 m	Red	–	H/D PNP	22	47	OJ5109
----------	------	-----	---	---------	----	----	---------------

Retro-reflective sensor · Cable 2 m · 10...30 DC · plastics · IP67



Polarisation filter	0...2 m	Red	64	H/D PNP	21	45	OJ5006
---------------------	---------	-----	----	---------	----	----	---------------

Type	Operating principle	Range	Type of light	Spot Ø at max. range [mm]	Output H = light-on D = dark-on	Wiring diagr. no.	Draw- ing no.	Order no.
Retro-reflective sensor · Cable 0.15 m · with M12 connector · 10...30 DC · plastics · IP67 · Connector groups 8, 10, 18, 20, 120, 124, 126, 128, 157								
	Polarisation filter	0...2 m	Red	64	H/D PNP	22	45	OJ5063
	Polarisation filter	0...2 m	Red	64	H/D PNP	22	45	OJ5062
Retro-reflective sensor · M8 connector · 10...30 DC · plastics · IP67 · Connector groups 4, 5, 74, 80, 124								
	Polarisation filter	0...2 m	Red	64	H/D PNP	22	46	OJ5004
	Polarisation filter	0...2 m	Red	64	H/D NPN	23	46	OJ5005
	Polarisation filter	0...2 m	Red	64	H/D PNP	22	47	OJ5104
Diffuse reflection sensor · Cable 0.15 m · with M12 connector · 10...30 DC · plastics · IP67 · Connector groups 8, 10, 18, 20, 120, 124, 126, 128, 157								
	Diffuse reflection sensor	1...600 mm	Red	60	H/D PNP	22	48	OJ5061
	Diffuse reflection sensor	1...600 mm	Red	60	H/D PNP	22	48	OJ5060
	Background suppression	15...400 mm	Red	< 18	H/D PNP	22	49	OJ5069
Diffuse reflection sensor · M8 connector · 10...30 DC · plastics · IP67 · Connector groups 4, 5, 74, 80, 124								
	Diffuse reflection sensor	1...600 mm	Red	60	H/D PNP	22	50	OJ5000
	Diffuse reflection sensor	1...600 mm	Red	60	H/D NPN	23	50	OJ5001
	Diffuse reflection sensor	1...1000 mm	Infrared	150	H/D PNP	22	50	OJ5070
	Background suppression	15...400 mm	Red	< 18	H/D PNP	22	51	OJ5044
	Diffuse reflection sensor	1...600 mm	Red	60	H/D PNP	22	52	OJ5100
	Background suppression	15...400 mm	Red	< 18	H/D PNP	22	53	OJ5144

Rectangular plastic housing in O6 design

Type	Operating principle	Range	Type of light	Spot Ø at max. range [mm]	Output H = light-on D = dark-on	Wiring diagr. no.	Draw- ing no.	Order no.
Through-beam sensor · Cable 2 m · 10...30 DC · plastics · IP65 / IP67								
	Transmitter	10 m	Red	300	–	1	54	O6S200
	Receiver	10 m	Red	–	H/D PNP	11	55	O6E200
	Receiver	10 m	Red	–	H/D NPN	24	55	O6E204
Through-beam sensor · Cable 0.3 m · with M12 connector, 4 poles · 10...30 DC · plastics · IP65 / IP67 · Connector groups 8, 10, 18, 20, 120, 124, 126, 128, 157								
	Transmitter	10 m	Red	300	–	2	54	O6S201
Through-beam sensor · Cable 0.3 m · with M12 connector, 4 poles · 10...30 DC · plastics · IP65 / IP67 · Connector groups 8, 10, 11, 18, 20, 120, 124, 126, 128, 130, 157, 158								
	Receiver	10 m	Red	–	H/D PNP	4	55	O6E201
Through-beam sensor · Cable 0.3 m · with M12 connector, 4 poles · 10...30 DC · plastics · IP65 / IP67 · Connector groups 8, 10, 18, 20, 120, 124, 126, 128, 157								
	Receiver	10 m	Red	–	H/D NPN	6	55	O6E205
Through-beam sensor · M8 connector, 3 poles · 10...30 DC · plastics · IP65 / IP67 · Connector groups 1, 3, 72, 78, 120								
	Transmitter	10 m	Red	300	–	2	56	O6S202
Through-beam sensor · M8 connector, 3 poles · 10...30 DC · plastics · IP65 / IP67 · Connector groups 1, 2, 3, 72, 78, 120, 122								
	Receiver	10 m	Red	–	H/D PNP	4	57	O6E202
Through-beam sensor · M8 connector, 4 poles · 10...30 DC · plastics · IP65 / IP67 · Connector groups 4, 5, 74, 80, 124								
	Receiver	10 m	Red	–	H/D PNP	4	57	O6E203
Through-beam sensor · M8 connector, 3 poles · 10...30 DC · plastics · IP65 / IP67 · Connector groups 1, 3, 72, 78, 120								
	Receiver	10 m	Red	–	H/D NPN	6	57	O6E206

Type	Operating principle	Range	Type of light	Spot Ø at max. range [mm]	Output H = light-on D = dark-on	Wiring diagr. no.	Draw- ing no.	Order no.
Through-beam sensor · M8 connector, 4 poles · 10...30 DC · plastics · IP65 / IP67 · Connector groups 4, 5, 74, 80, 124								
	Receiver	10 m	Red	–	H/D NPN	6	57	O6E207
	Receiver	15 m	Infrared	–	H/D NPN	25	57	O6E216
	Receiver	15 m	Infrared	–	H/D PNP	4	57	O6E215
Diffuse reflection sensor · Cable 2 m · 10...30 DC · plastics · IP65 / IP67								
	Background suppression	2...200 mm	Red	8	H/D PNP	11	58	O6H200
Diffuse reflection sensor · Cable 0.3 m · with M12 connector, 4 poles · 10...30 DC · plastics · IP65 / IP67 · Connector groups 8, 10, 11, 18, 20, 120, 124, 126, 128, 130, 157, 158								
	Background suppression	2...200 mm	Red	8	H/D PNP	4	58	O6H201
Diffuse reflection sensor · M8 connector, 3 poles · 10...30 DC · plastics · IP65 / IP67 · Connector groups 1, 2, 3, 72, 78, 120, 122								
	Background suppression	2...200 mm	Red	8	H/D PNP	4	59	O6H202
Diffuse reflection sensor · M8 connector, 4 poles · 10...30 DC · plastics · IP65 / IP67 · Connector groups 4, 5, 74, 80, 124								
	Background suppression	2...200 mm	Red	8	H/D PNP	4	59	O6H203
Diffuse reflection sensor · Cable 2 m · 10...30 DC · plastics · IP65 / IP67								
	Background suppression	2...200 mm	Red	8	H/D NPN	24	58	O6H204
Diffuse reflection sensor · Cable 0.3 m · with M12 connector, 4 poles · 10...30 DC · plastics · IP65 / IP67 · Connector groups 8, 10, 18, 20, 120, 124, 126, 128, 157								
	Background suppression	2...200 mm	Red	8	H/D NPN	6	58	O6H205
Diffuse reflection sensor · M8 connector, 3 poles · 10...30 DC · plastics · IP65 / IP67 · Connector groups 1, 3, 72, 78, 120								
	Background suppression	2...200 mm	Red	8	H/D NPN	6	59	O6H206
Diffuse reflection sensor · M8 connector, 4 poles · 10...30 DC · plastics · IP65 / IP67 · Connector groups 4, 5, 74, 80, 124								
	Background suppression	2...200 mm	Red	8	H/D NPN	6	59	O6H207











Position sensors

Type	Operating principle	Range	Type of light	Spot Ø at max. range [mm]	Output H = light-on D = dark-on	Wiring diagr. no.	Draw- ing no.	Order no.
Retro-reflective sensor · Cable 2 m · 10...30 DC · plastics · IP65 / IP67								
	Polarisation filter	0.05...5 m	Red	150	H/D PNP	11	58	O6P200
Retro-reflective sensor · Cable 0.3 m · with M12 connector, 4 poles · 10...30 DC · plastics · IP65 / IP67 · Connector groups 8, 10, 11, 18, 20, 120, 124, 126, 128, 130, 157, 158								
	Polarisation filter	0.05...5 m	Red	150	H/D PNP	4	58	O6P201
Retro-reflective sensor · M8 connector, 3 poles · 10...30 DC · plastics · IP65 / IP67 · Connector groups 1, 2, 3, 72, 78, 120, 122								
	Polarisation filter	0.05...5 m	Red	150	H/D PNP	4	59	O6P202
Retro-reflective sensor · M8 connector, 4 poles · 10...30 DC · plastics · IP65 / IP67 · Connector groups 4, 5, 74, 80, 124								
	Polarisation filter	0.05...5 m	Red	150	H/D PNP	4	59	O6P203
Retro-reflective sensor · Cable 2 m · 10...30 DC · plastics · IP65 / IP67								
	Polarisation filter	0.05...5 m	Red	150	H/D NPN	24	58	O6P204
Retro-reflective sensor · Cable 0.3 m · with M12 connector, 4 poles · 10...30 DC · plastics · IP65 / IP67 · Connector groups 8, 10, 18, 20, 120, 124, 126, 128, 157								
	Polarisation filter	0.05...5 m	Red	150	H/D NPN	6	58	O6P205
Retro-reflective sensor · M8 connector, 3 poles · 10...30 DC · plastics · IP65 / IP67 · Connector groups 1, 3, 72, 78, 120								
	Polarisation filter	0.05...5 m	Red	150	H/D NPN	6	59	O6P206
Retro-reflective sensor · M8 connector, 4 poles · 10...30 DC · plastics · IP65 / IP67 · Connector groups 4, 5, 74, 80, 124								
	Polarisation filter	0.05...5 m	Red	150	H/D NPN	6	59	O6P207
Through-beam sensor · M8 connector, 4 poles · 10...30 DC · plastics · IP65 / IP67 · Connector groups 4, 5, 74, 80, 124								
	Transmitter	10 m	Red	300	–	2	56	O6S203
	Transmitter	15 m	Infrared	460	–	2	56	O6S215









Type	Operating principle	Range	Type of light	Spot Ø at max. range [mm]	Output H = light-on D = dark-on	Wiring diagr. no.	Draw- ing no.	Order no.
Diffuse reflection sensor · Cable 2 m · 10...30 DC · plastics · IP65 / IP67								
	Diffuse reflection sensor	5...500 mm	Red	15	H/D PNP	11	58	O6T200
Diffuse reflection sensor · Cable 0.3 m · with M12 connector, 4 poles · 10...30 DC · plastics · IP65 / IP67 · Connector groups 8, 10, 11, 18, 20, 120, 124, 126, 128, 130, 157, 158								
	Diffuse reflection sensor	5...500 mm	Red	15	H/D PNP	4	58	O6T201
Diffuse reflection sensor · M8 connector, 3 poles · 10...30 DC · plastics · IP65 / IP67 · Connector groups 1, 2, 3, 72, 78, 120, 122								
	Diffuse reflection sensor	5...500 mm	Red	15	H/D PNP	4	59	O6T202
Diffuse reflection sensor · M8 connector, 4 poles · 10...30 DC · plastics · IP65 / IP67 · Connector groups 4, 5, 74, 80, 124								
	Diffuse reflection sensor	5...500 mm	Red	15	H/D PNP	4	59	O6T203
Diffuse reflection sensor · Cable 2 m · 10...30 DC · plastics · IP65 / IP67								
	Diffuse reflection sensor	5...500 mm	Red	15	H/D NPN	24	58	O6T204
Diffuse reflection sensor · Cable 0.3 m · with M12 connector, 4 poles · 10...30 DC · plastics · IP65 / IP67 · Connector groups 8, 10, 18, 20, 120, 124, 126, 128, 157								
	Diffuse reflection sensor	5...500 mm	Red	15	H/D NPN	6	58	O6T205
Diffuse reflection sensor · M8 connector, 3 poles · 10...30 DC · plastics · IP65 / IP67 · Connector groups 1, 3, 72, 78, 120								
	Diffuse reflection sensor	5...500 mm	Red	15	H/D NPN	6	59	O6T206
Diffuse reflection sensor · M8 connector, 4 poles · 10...30 DC · plastics · IP65 / IP67 · Connector groups 4, 5, 74, 80, 124								
	Diffuse reflection sensor	5...500 mm	Red	15	H/D NPN	6	59	O6T207
	Diffuse reflection sensor	5...600 mm	Infrared	24	H/D NPN	25	59	O6T216
	Diffuse reflection sensor	5...600 mm	Infrared	24	H/D PNP	4	59	O6T215

Rectangular housing O6 PerformanceLine, WetLine for hygienic and wet areas

Type	Operating principle	Range	Type of light	Spot Ø at max. range [mm]	Output H = light-on D = dark-on	Wiring diagr. no.	Draw- ing no.	Order no.
Through-beam sensor · Cable 2 m · 10...30 DC · high-grade stainless steel · IP65 / IP67 ; IP68 / IP69K								
	Transmitter	10 m	Red	300	–	1	60	O6S300
	Receiver	10 m	Red	–	H/D PNP	11	61	O6E300
Through-beam sensor · Cable 0.3 m · with M12 connector · 10...30 DC · high-grade stainless steel · IP65 / IP67 ; IP68 / IP69K · Connector groups 120, 124, 126, 130								
	Receiver	10 m	Red	–	H/D PNP	4	61	O6E301
Through-beam sensor · M8 connector · 10...30 DC · high-grade stainless steel · IP65 / IP67 ; IP68 / IP69K · Connector group 120								
	Transmitter	10 m	Red	300	–	2	62	O6S302
Through-beam sensor · M8 connector · 10...30 DC · high-grade stainless steel · IP65 / IP67 ; IP68 / IP69K · Connector groups 120, 122								
	Receiver	10 m	Red	–	H/D PNP	4	63	O6E302
Through-beam sensor · M8 connector · 10...30 DC · high-grade stainless steel · IP65 / IP67 ; IP68 / IP69K · Connector group 124								
	Receiver	10 m	Red	–	H/D PNP	4	63	O6E303
Through-beam sensor · Cable 0.3 m · with M12 connector · 10...30 DC · high-grade stainless steel · IP65 / IP67 ; IP68 / IP69K · Connector groups 120, 124, 126								
	Transmitter	10 m	Red	300	–	2	60	O6S301
Through-beam sensor · Cable 2 m · 10...30 DC · high-grade stainless steel · IP65 / IP67 ; IP68 / IP69K								
	Receiver	10 m	Red	–	H/D NPN	24	61	O6E304
Through-beam sensor · M8 connector · 10...30 DC · high-grade stainless steel · IP65 / IP67 ; IP68 / IP69K · Connector group 124								
	Transmitter	10 m	Red	300	–	26	62	O6S305
Through-beam sensor · Cable 0.3 m · with M12 connector · 10...30 DC · high-grade stainless steel · IP65 / IP67 ; IP68 / IP69K · Connector groups 120, 124, 126								
	Receiver	10 m	Red	–	H/D NPN	6	61	O6E305





Type	Operating principle	Range	Type of light	Spot Ø at max. range [mm]	Output H = light-on D = dark-on	Wiring diagr. no.	Draw- ing no.	Order no.
Through-beam sensor · M8 connector · 10...30 DC · high-grade stainless steel · IP65 / IP67 ; IP68 / IP69K · Connector group 124								
	Transmitter	10 m	Red	300	–	2	62	O6S303
	Receiver	10 m	Red	–	H/D PNP	4	63	O6E309
Through-beam sensor · M8 connector · 10...30 DC · high-grade stainless steel · IP65 / IP67 ; IP68 / IP69K · Connector group 120								
	Receiver	10 m	Red	–	H/D NPN	6	63	O6E306
Through-beam sensor · M8 connector · 10...30 DC · high-grade stainless steel · IP65 / IP67 ; IP68 / IP69K · Connector group 124								
	Receiver	10 m	Red	–	H/D NPN	6	63	O6E307
Diffuse reflection sensor · Cable 2 m · 10...30 DC · high-grade stainless steel · IP65 / IP67 ; IP68 / IP69K								
	Background suppression	2...200 mm	Red	8	H/D PNP	11	64	O6H300
Diffuse reflection sensor · Cable 0.3 m · with M12 connector · 10...30 DC · high-grade stainless steel · IP65 / IP67 ; IP68 / IP69K · Connector groups 120, 124, 126, 130								
	Background suppression	2...200 mm	Red	8	H/D PNP	4	64	O6H301
Diffuse reflection sensor · M8 connector · 10...30 DC · high-grade stainless steel · IP65 / IP67 ; IP68 / IP69K · Connector groups 120, 122								
	Background suppression	2...200 mm	Red	8	H/D PNP	4	65	O6H302
Diffuse reflection sensor · M8 connector · 10...30 DC · high-grade stainless steel · IP65 / IP67 ; IP68 / IP69K · Connector group 124								
	Background suppression	2...200 mm	Red	8	H/D PNP	4	65	O6H303
Diffuse reflection sensor · Cable 2 m · 10...30 DC · high-grade stainless steel · IP65 / IP67 ; IP68 / IP69K								
	Background suppression	2...200 mm	Red	8	H/D NPN	24	64	O6H304
Diffuse reflection sensor · Cable 0.3 m · with M12 connector · 10...30 DC · high-grade stainless steel · IP65 / IP67 ; IP68 / IP69K · Connector groups 120, 124, 126								
	Background suppression	2...200 mm	Red	8	H/D NPN	6	64	O6H305

Position sensors





Type	Operating principle	Range	Type of light	Spot Ø at max. range [mm]	Output H = light-on D = dark-on	Wiring diagr. no.	Draw- ing no.	Order no.
Diffuse reflection sensor · M8 connector · 10...30 DC · high-grade stainless steel · IP65 / IP67 ; IP68 / IP69K · Connector group 120								
	Background suppression	2...200 mm	Red	8	H/D NPN	6	65	O6H306
Diffuse reflection sensor · M8 connector · 10...30 DC · high-grade stainless steel · IP65 / IP67 ; IP68 / IP69K · Connector group 124								
	Background suppression	2...200 mm	Red	8	H/D NPN	6	65	O6H307
	Background suppression	2...200 mm	Red	8	H/D PNP	4	65	O6H309
Diffuse reflection sensor · M8 connector · 10...30 DC · plastics · IP65 / IP67 · Connector groups 4, 5, 74, 80, 124								
	Background suppression	2...200 mm	Red	8	H+D PNP	27	66	O6H210
	Background suppression	100 mm	Red	6	H PNP	4	67	O6H211
	Background suppression	200 mm	Red	8	H PNP	4	67	O6H212
	Background suppression	100 mm	Red	6	H NPN	6	67	O6H213
	Background suppression	200 mm	Red	8	H NPN	6	67	O6H214
Diffuse reflection sensor · M8 connector · 10...30 DC · high-grade stainless steel · IP65 / IP67 ; IP68 / IP69K · Connector group 124								
	Background suppression	2...200 mm	Red	8	H+D PNP	27	68	O6H310
Retro-reflective sensor · Cable 2 m · 10...30 DC · high-grade stainless steel · IP65 / IP67 ; IP68 / IP69K								
	Polarisation filter	0.05...5 m	Red	150	H/D PNP	11	64	O6P300
Retro-reflective sensor · Cable 0.3 m · with M12 connector · 10...30 DC · high-grade stainless steel · IP65 / IP67 ; IP68 / IP69K · Connector groups 120, 124, 126, 130								
	Polarisation filter	0.05...5 m	Red	150	H/D PNP	4	64	O6P301
Retro-reflective sensor · M8 connector · 10...30 DC · high-grade stainless steel · IP65 / IP67 ; IP68 / IP69K · Connector groups 120, 122								
	Polarisation filter	0.05...5 m	Red	150	H/D PNP	4	65	O6P302

Type	Operating principle	Range	Type of light	Spot Ø at max. range [mm]	Output H = light-on D = dark-on	Wiring diagr. no.	Draw- ing no.	Order no.
Retro-reflective sensor · M8 connector · 10...30 DC · high-grade stainless steel · IP65 / IP67 ; IP68 / IP69K · Connector group 124								
	Polarisation filter	0.05...5 m	Red	150	H/D PNP	4	65	O6P303
Retro-reflective sensor · Cable 2 m · 10...30 DC · high-grade stainless steel · IP65 / IP67 ; IP68 / IP69K								
	Polarisation filter	0.05...5 m	Red	150	H/D NPN	24	64	O6P304
Retro-reflective sensor · Cable 0.3 m · with M12 connector · 10...30 DC · high-grade stainless steel · IP65 / IP67 ; IP68 / IP69K · Connector groups 120, 124, 126								
	Polarisation filter	0.05...5 m	Red	150	H/D NPN	6	64	O6P305
Retro-reflective sensor · M8 connector · 10...30 DC · high-grade stainless steel · IP65 / IP67 ; IP68 / IP69K · Connector group 120								
	Polarisation filter	0.05...5 m	Red	150	H/D NPN	6	65	O6P306
Retro-reflective sensor · M8 connector · 10...30 DC · high-grade stainless steel · IP65 / IP67 ; IP68 / IP69K · Connector group 124								
	Polarisation filter	0.05...5 m	Red	150	H/D NPN	6	65	O6P307
	Polarisation filter	0.05...5 m	Red	150	H/D PNP	4	65	O6P309
	Polarisation filter	0.05...5 m	Red	150	H+D PNP	28	68	O6P310
Diffuse reflection sensor · Cable 2 m · 10...30 DC · high-grade stainless steel · IP65 / IP67 ; IP68 / IP69K								
	Diffuse reflection sensor	5...500 mm	Red	15	H/D PNP	11	64	O6T300
Diffuse reflection sensor · Cable 0.3 m · with M12 connector · 10...30 DC · high-grade stainless steel · IP65 / IP67 ; IP68 / IP69K · Connector groups 120, 124, 126, 130								
	Diffuse reflection sensor	5...500 mm	Red	15	H/D PNP	4	64	O6T301
Diffuse reflection sensor · M8 connector · 10...30 DC · high-grade stainless steel · IP65 / IP67 ; IP68 / IP69K · Connector groups 120, 122								
	Diffuse reflection sensor	5...500 mm	Red	15	H/D PNP	4	65	O6T302
Diffuse reflection sensor · M8 connector · 10...30 DC · high-grade stainless steel · IP65 / IP67 ; IP68 / IP69K · Connector group 124								
	Diffuse reflection sensor	5...500 mm	Red	15	H/D PNP	4	65	O6T303

Position sensors

Type	Operating principle	Range	Type of light	Spot Ø at max. range [mm]	Output H = light-on D = dark-on	Wiring diagr. no.	Draw- ing no.	Order no.
Diffuse reflection sensor · Cable 2 m · 10...30 DC · high-grade stainless steel · IP65 / IP67 ; IP68 / IP69K								
	Diffuse reflection sensor	5...500 mm	Red	15	H/D NPN	24	64	O6T304
Diffuse reflection sensor · Cable 0.3 m · with M12 connector · 10...30 DC · high-grade stainless steel · IP65 / IP67 ; IP68 / IP69K · Connector groups 120, 124, 126								
	Diffuse reflection sensor	5...500 mm	Red	15	H/D NPN	6	64	O6T305
Diffuse reflection sensor · M8 connector · 10...30 DC · high-grade stainless steel · IP65 / IP67 ; IP68 / IP69K · Connector group 120								
	Diffuse reflection sensor	5...500 mm	Red	15	H/D NPN	6	65	O6T306
Diffuse reflection sensor · M8 connector · 10...30 DC · high-grade stainless steel · IP65 / IP67 ; IP68 / IP69K · Connector group 124								
	Diffuse reflection sensor	5...500 mm	Red	15	H/D NPN	6	65	O6T307
	Diffuse reflection sensor	5...500 mm	Red	15	H/D PNP	4	65	O6T309

Rectangular housing O5 BasicLine

Type	Operating principle	Range	Type of light	Spot Ø at max. range [mm]	Output H = light-on D = dark-on	Wiring diagr. no.	Draw- ing no.	Order no.
Through-beam sensor · M12 connector · 10...36 DC · plastics · IP67 · Connector groups 8, 10, 18, 20, 120, 124, 126, 128, 157								
	Transmitter	20 m	Red	500	–	2	69	O5S200
Through-beam sensor · M12 connector · 10...36 DC · plastics · IP67 · Connector groups 8, 10, 11, 18, 20, 120, 124, 126, 128, 130, 157, 158								
	Receiver	20 m	Red	–	D PNP	15	69	O5E200
Retro-reflective sensor · M12 connector · 10...36 DC · plastics · IP67 · Connector groups 8, 10, 11, 18, 20, 120, 124, 126, 128, 130, 157, 158								
	Polarisation filter	0.1...7 m	Red	175	D PNP	15	70	O5P200
Retro-reflective sensor · M12 connector · 10...36 DC · plastics · IP67 · Connector groups 8, 9, 10, 11, 18, 20, 120, 124, 126, 128, 130, 131, 157, 158								
	Polarisation filter	0.1...7 m	Red	175	H PNP	29	70	O5P201

Type	Operating principle	Range	Type of light	Spot Ø at max. range [mm]	Output H = light-on D = dark-on	Wiring diagr. no.	Draw- ing no.	Order no.
------	---------------------	-------	---------------	---------------------------	---------------------------------------	-------------------------	---------------------	--------------

Diffuse reflection sensor · M12 connector · 10...36 DC · plastics · IP65 · Connector groups 8, 10, 11, 18, 20, 120, 124, 126, 128, 130, 157, 158

	Background suppression	50...1400 mm	Red	50	H PNP	5	71	O5H200
---	------------------------	--------------	-----	----	-------	---	----	---------------

Diffuse reflection sensor · M12 connector · 10...36 DC · plastics · IP67 · Connector groups 8, 10, 18, 20, 120, 124, 126, 128, 157

	Background suppression	50...1400 mm	Red	50	H NPN	18	71	O5H201
---	------------------------	--------------	-----	----	-------	----	----	---------------

Rectangular housing O5 PerformanceLine

Type	Operating principle	Range	Type of light	Spot Ø at max. range [mm]	Output H = light-on D = dark-on	Wiring diagr. no.	Draw- ing no.	Order no.
------	---------------------	-------	---------------	---------------------------	---------------------------------------	-------------------------	---------------------	--------------

Through-beam sensor · Cable 2 m · 10...36 DC · plastics · IP67

	Transmitter	25 m	Red	625	–	1	72	O5S501
	Receiver	25 m	Red	–	H/D PNP	11	73	O5E501

Through-beam sensor · M12 connector · 10...36 DC · plastics · IP67 · Connector groups 8, 10, 18, 20, 120, 124, 126, 128, 157

	Transmitter	25 m	Red	625	–	2	69	O5S500
---	-------------	------	-----	-----	---	---	----	---------------

Through-beam sensor · M12 connector · 10...36 DC · plastics · IP67 · Connector groups 8, 10, 11, 18, 20, 120, 124, 126, 128, 130, 157, 158

	Receiver	25 m	Red	–	H/D PNP	4	74	O5E500
---	----------	------	-----	---	---------	---	----	---------------

Through-beam sensor · M12 connector · 10...36 DC · plastics · IP67 · Connector groups 8, 10, 18, 20, 120, 124, 126, 128, 157

	Receiver	25 m	Red	–	H/D NPN	6	74	O5E502
---	----------	------	-----	---	---------	---	----	---------------

Retro-reflective sensor · Cable 2 m · 10...36 DC · plastics · IP67

	Polarisation filter	0.075...10 m	Red	250	H/D PNP	11	75	O5P501
---	---------------------	--------------	-----	-----	---------	----	----	---------------

Retro-reflective sensor · M12 connector · 10...36 DC · plastics · IP67 · Connector groups 8, 10, 11, 18, 20, 120, 124, 126, 128, 130, 157, 158

	Polarisation filter	0.075...10 m	Red	250	H/D PNP	4	76	O5P500
---	---------------------	--------------	-----	-----	---------	---	----	---------------

Position sensors

Type	Operating principle	Range	Type of light	Spot Ø at max. range [mm]	Output H = light-on D = dark-on	Wiring diagr. no.	Draw- ing no.	Order no.
------	---------------------	-------	---------------	---------------------------	---------------------------------------	-------------------------	---------------------	--------------

Retro-reflective sensor · M12 connector · 10...36 DC · plastics · IP67 · Connector groups 8, 10, 18, 20, 120, 124, 126, 128, 157

	Polarisation filter	0.075...10 m	Red	250	H/D NPN	6	76	O5P502
---	---------------------	--------------	-----	-----	---------	---	----	---------------

Diffuse reflection sensor · Cable 2 m · 10...36 DC · plastics · IP67

	Background suppression	50...1800 mm	Red	50	H/D PNP	11	75	O5H503
---	------------------------	--------------	-----	----	---------	----	----	---------------

Diffuse reflection sensor · M12 connector · 10...36 DC · plastics · IP67 · Connector groups 8, 10, 11, 18, 20, 120, 124, 126, 128, 130, 157, 158

	Background suppression	50...1800 mm	Red	50	H/D PNP	4	76	O5H500
	Background suppression	60...700 mm	Red	35	H/D PNP	4	76	O5H501

Diffuse reflection sensor · M12 connector · 10...36 DC · plastics · IP67 · Connector groups 8, 10, 18, 20, 120, 124, 126, 128, 157

	Background suppression	50...1800 mm	Red	50	H/D NPN	6	76	O5H504
---	------------------------	--------------	-----	----	---------	---	----	---------------

Rectangular housing O5 PerformanceLine with ATEX approval 3D

Type	Operating principle	Range	Type of light	Spot Ø at max. range [mm]	Output H = light-on D = dark-on	Wiring diagr. no.	Draw- ing no.	Order no.
------	---------------------	-------	---------------	---------------------------	---------------------------------------	-------------------------	---------------------	--------------

Through-beam sensor · M12 connector · 10...30 DC · plastics · IP65 · Connector groups 154, 156

	Transmitter	25 m	Red	625	–	2	77	O5S51A
	Receiver	25 m	Red	–	H/D PNP	4	77	O5E51A



Retro-reflective sensor · M12 connector · 10...30 DC · plastics · IP65 · Connector groups 154, 156

	Polarisation filter	0.075...10 m	Red	250	H/D PNP	4	77	O5P51A
---	---------------------	--------------	-----	-----	---------	---	----	---------------

Diffuse reflection sensor · M12 connector · 10...30 DC · plastics · IP65 · Connector groups 154, 156

	Background suppression	50...1800 mm	Red	50	H/D PNP	4	77	O5H51A
---	------------------------	--------------	-----	----	---------	---	----	---------------



Rectangular housing OL BasicLine

Type	Operating principle	Range	Type of light	Spot Ø at max. range [mm]	Output H = light-on D = dark-on	Wiring diagr. no.	Draw- ing no.	Order no.
Through-beam sensor · Terminals · 20...250 AC/DC (47...63 Hz AC) · plastics · IP67								
	Transmitter	25 m	Infrared	< 2500	–	30	78	OL0006
	Receiver	25 m	Infrared	–	H/D Relay	31	78	OL0007
Retro-reflective sensor · Terminals · 20...250 AC/DC (47...63 Hz AC) · plastics · IP67								
	Polarisation filter	0.3...5 m	Red	250	H/D Relay	31	79	OL0004*
Diffuse reflection sensor · Terminals · 20...250 AC/DC (47...63 Hz AC) · plastics · IP67								
	Diffuse reflection sensor	1...1000 mm	Infrared	< 300	H/D Relay	31	78	OL0005*
	Diffuse reflection sensor	1...800 mm	Infrared	< 80	H/D Relay	31	78	OL0009*

* Note for AC and AC/DC units

Miniature fuse to IEC60127-2 sheet 1, ≤ 5 A (fast acting) Recommendation: check the unit for reliable function after a short circuit.

Rectangular housing O4 BasicLine

Type	Operating principle	Range	Type of light	Spot Ø at max. range [mm]	Output H = light-on D = dark-on	Wiring diagr. no.	Draw- ing no.	Order no.
Through-beam sensor · M12 connector · 10...36 DC · plastics · IP67 · Connector groups 8, 10, 18, 20, 120, 124, 126, 128, 157								
	Transmitter	0...50 m	Red	1000	–	2	80	O4S200
Through-beam sensor · M12 connector · 10...36 DC · plastics · IP67 · Connector groups 8, 10, 11, 18, 20, 120, 124, 126, 128, 130, 157, 158								
	Receiver	0...50 m	Red	–	D PNP	15	81	O4E200
	Receiver	0...50 m	Red	–	H PNP	5	81	O4E201
Retro-reflective sensor · M12 connector · 10...36 DC · plastics · IP67 · Connector groups 8, 10, 11, 18, 20, 120, 124, 126, 128, 130, 157, 158								
	Polarisation filter	0.3...18 m	Red	500	D PNP	15	82	O4P200

You can find wiring diagrams and scale drawings from page 244

Position sensors

Type	Operating principle	Range	Type of light	Spot Ø at max. range [mm]	Output H = light-on D = dark-on	Wiring diagr. no.	Draw- ing no.	Order no.
------	---------------------	-------	---------------	---------------------------	---------------------------------------	-------------------------	---------------------	--------------

Retro-reflective sensor · M12 connector · 10...36 DC · plastics · IP67 · Connector groups 8, 10, 11, 18, 20, 120, 124, 126, 128, 130, 157, 158



Polarisation filter	0.3...18 m	Red	500	H PNP	5	82	O4P201
---------------------	------------	-----	-----	-------	---	----	---------------

Diffuse reflection sensor · M12 connector · 10...36 DC · plastics · IP65 · Connector groups 8, 10, 11, 18, 20, 120, 124, 126, 128, 130, 157, 158



Background suppression	100...2000 mm	Red	100	H PNP	5	83	O4H200
------------------------	---------------	-----	-----	-------	---	----	---------------

Background suppression	100...2000 mm	Red	100	D PNP	15	83	O4H201
------------------------	---------------	-----	-----	-------	----	----	---------------

Rectangular housing O4 PerformanceLine

Type	Operating principle	Range	Type of light	Spot Ø at max. range [mm]	Output H = light-on D = dark-on	Wiring diagr. no.	Draw- ing no.	Order no.
------	---------------------	-------	---------------	---------------------------	---------------------------------------	-------------------------	---------------------	--------------

Through-beam sensor · Cable 2 m · 10...36 DC · plastics · IP67



Transmitter	80 m	Red	2400	–	1	84	O4S501
-------------	------	-----	------	---	---	----	---------------

Receiver	80 m	Red	–	H/D PNP	11	85	O4E501
----------	------	-----	---	---------	----	----	---------------

Through-beam sensor · M12 connector · 10...36 DC · plastics · IP67 · Connector groups 8, 10, 18, 20, 120, 124, 126, 128, 157



Transmitter	80 m	Red	2400	–	2	80	O4S500
-------------	------	-----	------	---	---	----	---------------

Through-beam sensor · M12 connector · 10...36 DC · plastics · IP67 · Connector groups 8, 10, 11, 18, 20, 120, 124, 126, 128, 130, 157, 158



Receiver	80 m	Red	–	H/D PNP	4	86	O4E500
----------	------	-----	---	---------	---	----	---------------

Retro-reflective sensor · Cable 2 m · 10...36 DC · plastics · IP67



Polarisation filter	0.3...22 m	Red	660	H/D PNP	11	87	O4P501
---------------------	------------	-----	-----	---------	----	----	---------------

Retro-reflective sensor · M12 connector · 10...36 DC · plastics · IP67 · Connector groups 8, 10, 11, 18, 20, 120, 124, 126, 128, 130, 157, 158



Polarisation filter	0.3...22 m	Red	660	H/D PNP	4	88	O4P500
---------------------	------------	-----	-----	---------	---	----	---------------

Diffuse reflection sensor · Cable 2 m · 10...36 DC · plastics · IP67



Background suppression	100...2600 mm	Red	50	H/D PNP	11	89	O4H501
------------------------	---------------	-----	----	---------	----	----	---------------

Type	Operating principle	Range	Type of light	Spot Ø at max. range [mm]	Output H = light-on D = dark-on	Wiring diagr. no.	Draw- ing no.	Order no.
------	---------------------	-------	---------------	---------------------------	---------------------------------------	-------------------------	---------------------	--------------

Diffuse reflection sensor · M12 connector · 10...36 DC · plastics · IP67 · Connector groups 8, 10, 11, 18, 20, 120, 124, 126, 128, 130, 157, 158





Background suppression 100...2600 mm Red 50 H/D PNP 4 90 **O4H500**



Prismatic reflectors, reflective tape and fixing components

Type	Description	Order no.
	Prismatic reflector · Ø 20 mm · round · For red light and infrared light retro-reflective sensors · Housing materials: plastics	E20003
	Prismatic reflector · Ø 25 mm · round · fixing by screw · For red light and infrared light retro-reflective sensors · Housing materials: plastics	E20953
	Prismatic reflector · Ø 35 mm · round · fixing by screw · For red light and infrared light retro-reflective sensors · Housing materials: plastics	E20954
	Prismatic reflector · Ø 42 mm · round · For red light and infrared light retro-reflective sensors · Housing materials: plastics	E20004
	Prismatic reflector · Ø 50 mm · round · fixing by screw · For red light and infrared light retro-reflective sensors · Housing materials: plastics	E20956
	Prismatic reflector · Ø 80 mm · round · For red light and infrared light retro-reflective sensors · Housing materials: plastics	E20005
	Prismatic reflector · 18 x 40 mm · rectangular · For red light and infrared light retro-reflective sensors · Housing materials: plastics	E21115
	Prismatic reflector · 45 x 28 mm · rectangular · For red light and infrared light retro-reflective sensors · Housing materials: plastics	E20452
	Prismatic reflector · 48 x 48 mm · rectangular · For red light and infrared light retro-reflective sensors · Housing materials: front plate: PMMA / base: ABS	E20744
	Prismatic reflector · 93 x 45 mm · rectangular · For red light and infrared light retro-reflective sensors · Housing materials: plastics	E20453
	Prismatic reflector · 96 x 96 mm · rectangular · For red light and infrared light retro-reflective sensors · Housing materials: plastics	E20454
	Prismatic reflector · 18 x 18 mm · rectangular · For red light and infrared light retro-reflective sensors · Housing materials: Solidchem	E21267





Type	Description	Order no.
	Prismatic reflector · 56 x 38 mm · rectangular · For red light and infrared light retro-reflective sensors · Housing materials: Solidchem	E21268
	Prismatic reflector · 48 x 48 mm · rectangular · For red light and infrared light retro-reflective sensors · Housing materials: Solidchem	E21269
	Prismatic reflector · 96 x 96 mm · rectangular · For red light and infrared light retro-reflective sensors · Housing materials: Solidchem	E21270
	Mounting set · for reflector · Clamp mounting · Rod mounting Ø 30 mm · Housing materials: fixture: stainless steel 316Ti / 1.4571 / clamp: aluminium transparent anodised	E21007
	Mounting set · for reflector · Ø 25 mm · Clamp mounting · free-standing M8 · Housing materials: fixture: stainless steel 316Ti / 1.4571 / clamp: stainless steel	E20903
	Mounting set · for reflector · Ø 35 mm · Clamp mounting · free-standing M8 · Housing materials: fixture: stainless steel 316Ti / 1.4571 / clamp: stainless steel	E20907
	Mounting set · for reflector · Ø 50 mm · Clamp mounting · Free-standing M10 · Housing materials: fixture: stainless steel 316Ti / 1.4571 / clamp: stainless steel	E20911
	Mounting set · for reflector · Ø 80 mm · Clamp mounting · free-standing M12 · Housing materials: fixture: stainless steel 316Ti / 1.4571 / clamp: diecast zinc	E20914
	Mounting set · for reflector · Ø 80 mm · Clamp mounting · free-standing M12 · Housing materials: fixture: stainless steel 316Ti / 1.4571 / clamp: stainless steel	E20915
	Angle bracket · for reflector · 50 x 50 mm · Housing materials: fixture: stainless steel 316Ti / 1.4571	E20724
	Reflective tape · TS-02 · 50 x 1000 mm · For red light and infrared light retro-reflective sensors · Housing materials: plastics / acrylic	E21015

Accessories OF design (M12)



Type	Description	Order no.
	angle support · 90° · for type OF · Housing materials: housing: ABS / lens: PC	E20590
	Angle bracket · Ø 12 mm · with end stop · Mounting clamp · Clamp mounting · for type IF, KF, OF · Housing materials: fixture: stainless steel / Mounting clamp: PC black	E21144

Type	Description	Order no.
	Mounting set · Ø 12.2 mm · Clamp mounting · rod mounting Ø 10 mm · for type OF, IF · Housing materials: fixture: stainless steel 316Ti / 1.4571 / clamp: diecast zinc	E21200
	Mounting set · Ø 12.2 mm · Clamp mounting · rod mounting Ø 10 mm · for type OF, IF · Housing materials: fixture: stainless steel 316Ti / 1.4571 / clamp: stainless steel	E21201
	Mounting set · Ø 12.2 mm · Clamp mounting · rod mounting Ø 10 mm · for type OF, IF · Housing materials: fixture: stainless steel 316Ti / 1.4571 / clamp: diecast zinc	E21202
	Mounting set · Ø 12.2 mm · Clamp mounting · rod mounting Ø 10 mm · for type OF, IF · Housing materials: fixture: stainless steel 316Ti / 1.4571 / clamp: stainless steel	E21203









Accessories OG design (M18)

Type	Description	Order no.
	Angle bracket · for type M18 · Housing materials: stainless steel	E10736
	Angle bracket · Ø 18 mm · with end stop · Mounting clamp · Clamp mounting · for type OG, IG, KG · Housing materials: fixture: stainless steel / Mounting clamp: PC black	E21145
	Mounting set · Ø 18.5 mm · Clamp mounting · rod mounting Ø 12 mm · for type OG, IG, KG · Housing materials: clamp: diecast zinc / fixture: steel	E20720
	Mounting set · Ø 18.5 mm · Clamp mounting · rod mounting Ø 12 mm · for type OG, IG, KG · Housing materials: clamp: diecast zinc / fixture: steel	E20721
	Mounting set · Ø 18.5 mm · Clamp mounting · rod mounting Ø 12 mm · for type OG, IG, KG · Housing materials: clamp: high-grade stainless steel / fixture: high-grade stainless steel	E21206
	Mounting set · Ø 18.5 mm · Clamp mounting · rod mounting Ø 12 mm · for type OG, IG, KG · Housing materials: clamp: high-grade stainless steel / fixture: high-grade stainless steel	E21207

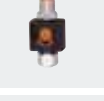

Accessories OI design (M30)

Type	Description	Order no.
	Angle bracket · for type M30 · Housing materials: stainless steel	E10737
	Mounting clamp · Ø 30 mm · with end stop · for type M30 · Housing materials: PC	E11049

Position sensors

Type	Description	Order no.
	Mounting clamp · Ø 34 mm - Ø 30 mm · with reducing bush · for type M30 · Housing materials: PBT	E10077
	Mounting set · Ø 30.2 mm · Clamp mounting · aluminium profile · for type II, KI, OID, OI · Housing materials: fixture: stainless steel 316Ti / 1.4571 / clamp: diecast zinc / Cube: diecast zinc	E20875
	Mounting set · Ø 30.2 mm · Clamp mounting · free-standing M12 · for type OI, II, KI · Housing materials: fixture: stainless steel 316Ti / 1.4571 / clamp: diecast zinc	E20873
	Mounting set · Ø 30.2 mm · Clamp mounting · free-standing M12 · for type OI, II, KI · Housing materials: fixture: stainless steel 316Ti / 1.4571 / clamp: stainless steel	E20874
	mounting rod · Ø 12 / M10 · Length: 130 mm · straight · Housing materials: stainless steel 316Ti / 1.4571	E20938
	Cube · M10 · aluminium profile · Housing materials: diecast zinc	E20951
	Memory plug · Parameter memory for IO-Link sensors · Storage capacity: 2 Kbytes · Housing materials: PA PACM 12 / PET / sealing: FPM / nut: stainless steel 316L / 1.4404 / connector: TPU	E30398
	IO-Link interface · for parameter setting and analysis of units with max. 65 mA current consumption · Supported communication protocols: IO-Link (4800 and 38400 bits/s) EPS protocol (19200 bits/s) · for operation with FDT framework software "ifm Container" or software "LINERECORDER SENSOR"	E30396
	LINERECORDER SENSOR · Version 4.0.0 · Software for clear online and offline parameter setting of IO-Link sensors via USB adapter · Use via USB connection cable (drivers are supplied): E30396 IO-Link interface or E30390 IO-Link master (note the respective data sheet) · IODD import and update from ifm's homepage · Reading of IODDs via storage media · Automatic sensor identification · Graphic representation of the process values and history incl. export function · Documentation and archiving · Transferable parameter sets · Full memory plug support for IO-Link 1.1	QA0001



Accessories OH housing

Type	Description	Order no.
	Angle bracket · for free-standing mounting · for type OH · Housing materials: Angle bracket: stainless steel 316Ti / 1.4571	E21057
	Mounting set · for type OH · Housing materials: ABS	E21056











Accessories O7 housing

Type	Description	Order no.
	Mounting set · O7 · Clamp mounting · rod mounting Ø 10 mm · Housing materials: fixture: stainless steel / clamp: stainless steel / screw: stainless steel / nut: stainless steel	E21237



Product selectors and further information can be found at: www.ifm.com

Type	Description	Order no.
	Mounting set · O7 · Free-standing mounting · free-standing · Housing materials: fixture: stainless steel / screws: stainless steel	E21238
	Mounting set · O7 · Free-standing mounting · with fine adjustment · free-standing · Housing materials: fixture: stainless steel / Spring: spring steel / screws: stainless steel	E21239
	Mounting set · O7 · ball joint · free-standing · Housing materials: fixture: diecast zinc / mounting base: diecast zinc / screws: stainless steel	E21240

Accessories OJ housing

Type	Description	Order no.
	Angle bracket · for type OJ · Housing materials: high-grade stainless steel	E20984
	Basic clip · OJ · Housing materials: high-grade stainless steel	E20965
	Basic clip · OJ · Housing materials: diecast zinc	E20964
	Swivel-mount clip · for type OJ · Housing materials: diecast zinc	E20974
	Mounting set · OJ · for side lens · Clamp mounting · free-standing M8 · Housing materials: fixture: stainless steel 316Ti / 1.4571 / clamp: diecast zinc	E20968
	Mounting set · OJ · for side lens · Clamp mounting · free-standing M8 · Housing materials: fixture: stainless steel 316Ti / 1.4571 / clamp: stainless steel	E20969
	Mounting set · OJ · for side lens · rod mounting Ø 10 mm · Housing materials: clamp: diecast zinc / fixture: stainless steel 316Ti / 1.4571	E21095
	Mounting set · OJ · for side lens · Clamp mounting · rod mounting Ø 10 mm · Housing materials: fixture: stainless steel 316Ti / 1.4571 / clamp: diecast zinc	E21222
	Mounting set · OJ · for side lens · Clamp mounting · rod mounting Ø 10 mm · Housing materials: fixture: stainless steel 316Ti / 1.4571 / clamp: stainless steel	E20973
	Mounting set · OJ · for front lens · Clamp mounting · free-standing M8 · Housing materials: clamp: diecast zinc / fixture: stainless steel 316Ti / 1.4571	E20966





Position sensors

Type	Description	Order no.
	Mounting set · OJ · for front lens · Clamp mounting · rod mounting Ø 10 mm · Housing materials: fixture: stainless steel 316Ti / 1.4571 / clamp: diecast zinc	E20970
	Mounting set · OJ · for front lens · Clamp mounting · rod mounting · Housing materials: fixture: stainless steel 316Ti / 1.4571 / clamp: stainless steel	E21221

Accessories for O6 design



Type	Description	Order no.
	Angle bracket · O6 · for type O6 · Housing materials: stainless steel 316Ti / 1.4571	E21271
	Mounting set · O6 · Clamp mounting · rod mounting Ø 10 mm · for type O6 · Housing materials: stainless steel 316Ti / 1.4571	E21272
	Protective cover · O6 · for type O6 · Housing materials: stainless steel 316Ti / 1.4571	E21273
	Pin hole · 0.5 mm · for type O6E / O6S plastic · Housing materials: stainless steel	E21277
	Slit diaphragm · 0.5 x 8 mm · for type O6E / O6S plastic · Housing materials: stainless steel	E21280

Accessories O5 housing



Type	Description	Order no.
	Angle bracket · for type O5 · Housing materials: stainless steel 316Ti / 1.4571	E21087
	Angle bracket · for type O5 · Housing materials: stainless steel 316Ti / 1.4571	E21085
	Angle bracket · O5, O4 · for mounting O5, O4 sensors instead of OL sensors · Dovetail clamp · Housing materials: Dovetail clamp: AlMgSi0.5 / fixture: AlMg3	E21122
	Dovetail clamp · for type DTS, O4, O5 · Housing materials: AlMgSi0.5	E21088
	Mounting brackets Mounting on the back of the unit · for type O5 · Housing materials: stainless steel 316Ti / 1.4571	E21086

Type	Description	Order no.
	Mounting sleeve · O5 · for mounting O5 sensors instead of OC sensors · Housing materials: AlZnMgCu1.5 F51/52	E21114
	Mounting set · Clamp mounting · With protective cover · rod mounting Ø 12 mm · for type O5 · Housing materials: fixture: stainless steel 316Ti / 1.4571 / clamp: high-grade stainless steel	E21223
	Mounting set · Clamp mounting · With protective cover · rod mounting Ø 12 mm · for type O5 · Housing materials: stainless steel 316Ti / 1.4571 / clamp: diecast zinc	E21210
	Mounting set · Clamp mounting · rod mounting Ø 12 mm · for type O5, O5D · Housing materials: stainless steel 316Ti / 1.4571 / clamp: diecast zinc	E21211
	Mounting set · Clamp mounting · rod mounting Ø 12 mm · for type O5, O5D · Housing materials: stainless steel 316Ti / 1.4571 / clamp: high-grade stainless steel	E21212
	Mounting set · Clamp mounting · With protective cover · rod mounting Ø 14 mm · for type O5 · Housing materials: fixture: stainless steel 316Ti / 1.4571 / clamp: stainless steel	E21142
	Mounting set · Clamp mounting · With protective cover · Free-standing M10 · for type O5 · Housing materials: stainless steel 316Ti / 1.4571 / clamp: diecast zinc	E21084
	Mounting set · Clamp mounting · Free-standing M10 · for type O5 · Housing materials: stainless steel 316Ti / 1.4571 / clamp: diecast zinc	E21083
	Memory plug · Parameter memory for IO-Link sensors · Storage capacity: 2 Kbytes · Housing materials: PA PACM 12 / PET / sealing: FPM / nut: stainless steel 316L / 1.4404 / connector: TPU	E30398
	IO-Link interface · for parameter setting and analysis of units with max. 65 mA current consumption · Supported communication protocols: IO-Link (4800 and 38400 bits/s) EPS protocol (19200 bits/s) · for operation with FDT framework software "ifm Container" or software "LINERECORDER SENSOR"	E30396
	LINERECORDER SENSOR · Version 4.0.0 · Software for clear online and offline parameter setting of IO-Link sensors via USB adapter · Use via USB connection cable (drivers are supplied): E30396 IO-Link interface or E30390 IO-Link master (note the respective data sheet) · IODD import and update from ifm's homepage · Reading of IODDs via storage media · Automatic sensor identification · Graphic representation of the process values and history incl. export function · Documentation and archiving · Transferable parameter sets · Full memory plug support for IO-Link 1.1	QA0001







Accessories OL housing



Type	Description	Order no.
	Angle bracket · for type OL · Housing materials: stainless steel	E20788
	Angle bracket · With protective cover · for type OL · Housing materials: stainless steel	E20789

Position sensors

Type	Description	Order no.
	Mounting set · Clamp mounting · free-standing M12 · for type OL · Housing materials: fixture: stainless steel / clamp: diecast zinc	E20792
	Mounting set · OL · Clamp mounting · rod mounting Ø 40 mm · Housing materials: fixture: stainless steel 316Ti / 1.4571 / clamp: aluminium transparent anodised	E21012
	Mounting set · Clamp mounting · With protective cover · free-standing M12 · for type OL · Housing materials: fixture: stainless steel / clamp: diecast zinc	E20793
	Mounting set · Clamp mounting · With protective cover · free-standing M12 · for type OL · Housing materials: clamp: stainless steel / fixture: stainless steel 316Ti / 1.4571	E20877

Accessories O4 housing

Type	Description	Order no.
	Angle bracket · O1D, O4 · for type O1D, O4 · Housing materials: stainless steel 316L / 1.4404	E21120
	Angle bracket · O4 · for type O4 · Housing materials: stainless steel 316L / 1.4404	E21117
	Angle bracket · O5, O4 · for mounting O5, O4 sensors instead of OL sensors · Dovetail clamp · Housing materials: Dovetail clamp: AlMgSi0.5 / fixture: AlMg3	E21122
	Dovetail clamp · for type DTS, O4, O5 · Housing materials: AlMgSi0.5	E21088
	Mounting brackets Mounting on the back of the unit · O4 · for type O4 · Housing materials: stainless steel 316Ti / 1.4571	E21116
	Mounting set · Clamp mounting · With protective cover · rod mounting Ø 12 mm · for type O4 · Housing materials: stainless steel 316L / 1.4404 / clamp: diecast zinc	E21215
	Mounting set · Clamp mounting · With protective cover · rod mounting Ø 12 mm · for type O4 · Housing materials: stainless steel 316L / 1.4404 / clamp: high-grade stainless steel	E21216
	Mounting set · Clamp mounting · rod mounting Ø 12 mm · for type O4 · Housing materials: stainless steel 316L / 1.4404 / clamp: diecast zinc	E21217
	Mounting set · Clamp mounting · rod mounting Ø 12 mm · for type O4 · Housing materials: stainless steel 316L / 1.4404 / clamp: high-grade stainless steel	E21218

Type	Description	Order no.
	Mounting set · O4 · Clamp mounting · for type O4 · Housing materials: stainless steel 316L / 1.4404 / clamp: diecast zinc	E21118
	Mounting set · O4 · Clamp mounting · With protective cover · for type O4 · Housing materials: stainless steel 316L / 1.4404 / clamp: diecast zinc	E21119
	Mounting set · O4 · Clamp mounting · for type O4 · Housing materials: stainless steel 316L / 1.4404 / clamp: diecast zinc	E21118

Accessories for system components

Type	Description	Order no.
	clamp · Ø 10 mm; M8 · free-standing M8 · Housing materials: clamp: diecast zinc	E20843
	clamp · Ø 10 mm; M8 · free-standing M8 · Housing materials: clamp: stainless steel 316Ti / 1.4571	E20844
	clamp · Ø 12 mm; M10 · Free-standing M10 · Housing materials: clamp: diecast zinc	E20716
	clamp · Ø 12 mm · rod mounting Ø 12 mm · Housing materials: clamp: diecast zinc	E20717
	clamp · Ø 12 mm · rod mounting Ø 12 mm · Housing materials: clamp: stainless steel	E21110
	clamp · Ø 14 mm; M12 · free-standing M12 · Housing materials: clamp: diecast zinc	E20796
	mounting rod · Ø 10 / M8 · Length: 150 mm · straight · Housing materials: stainless steel 316Ti / 1.4571	E21081
	mounting rod · Ø 10 / M8 · Length: 200 mm · angled · Housing materials: stainless steel 316Ti / 1.4571	E80310
	mounting rod · Ø 12 / M10 · Length: 130 mm · straight · Housing materials: stainless steel 316Ti / 1.4571	E20938
	mounting rod · Ø 12 / M10 · Length: 200 mm · angled · Housing materials: stainless steel 316Ti / 1.4571	E20940

Type	Description	Order no.
	Head cap screw · M8 x 40 mm · ISO 4762 (DIN 912) · free-standing M8 · Housing materials: screw: steel galvanised	E21204
	Head cap screw · M8 x 40 mm · ISO 4762 (DIN 912) · free-standing M8 · Housing materials: screw: high-grade stainless steel	E21205
	Head cap screw · M10 x 45 mm · ISO 4762 (DIN 912) · Free-standing M10 · Housing materials: screw: steel galvanised	E21208
	Head cap screw · M10 x 45 mm · ISO 4762 (DIN 912) · Free-standing M10 · Housing materials: screw: high-grade stainless steel	E21209
	Head cap screw · M10 x 120 mm · ISO 4762 (DIN 912) · Free-standing M10 · Housing materials: screw: steel galvanised	E21213
	Head cap screw · M10 x 120 mm · ISO 4762 (DIN 912) · Free-standing M10 · Housing materials: screw: high-grade stainless steel	E21214
	Cube · M8 · aluminium profile · Housing materials: diecast zinc	E20950
	Cube · M10 · aluminium profile · Housing materials: diecast zinc	E20951
	Protective bracket for free-standing and rod mounting · Ø 18 mm · Clamp mounting · Housing materials: stainless steel 316L / 1.4404	E21125
	Protective bracket for free-standing and rod mounting · Ø 18 mm · with end stop · Mounting clamp · Clamp mounting · Housing materials: Mounting clamp: PC black / Angle bracket: stainless steel 316L / 1.4404	E21126

Wiring diagrams

Core colours

- BN brown
- BU blue
- BK black
- WH white

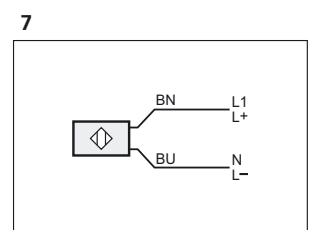
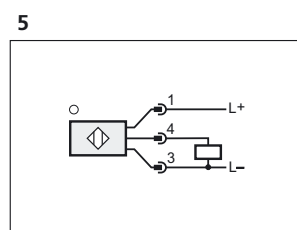
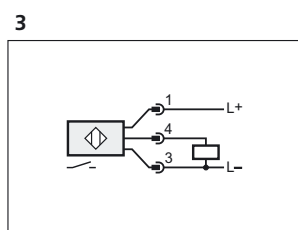
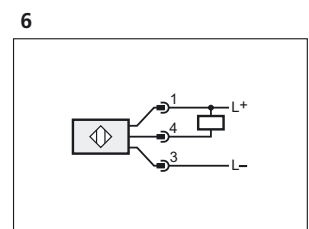
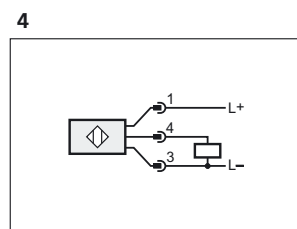
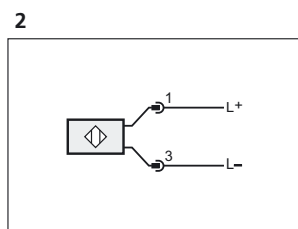
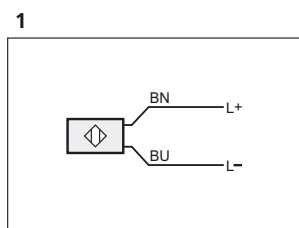

Wiring diagrams

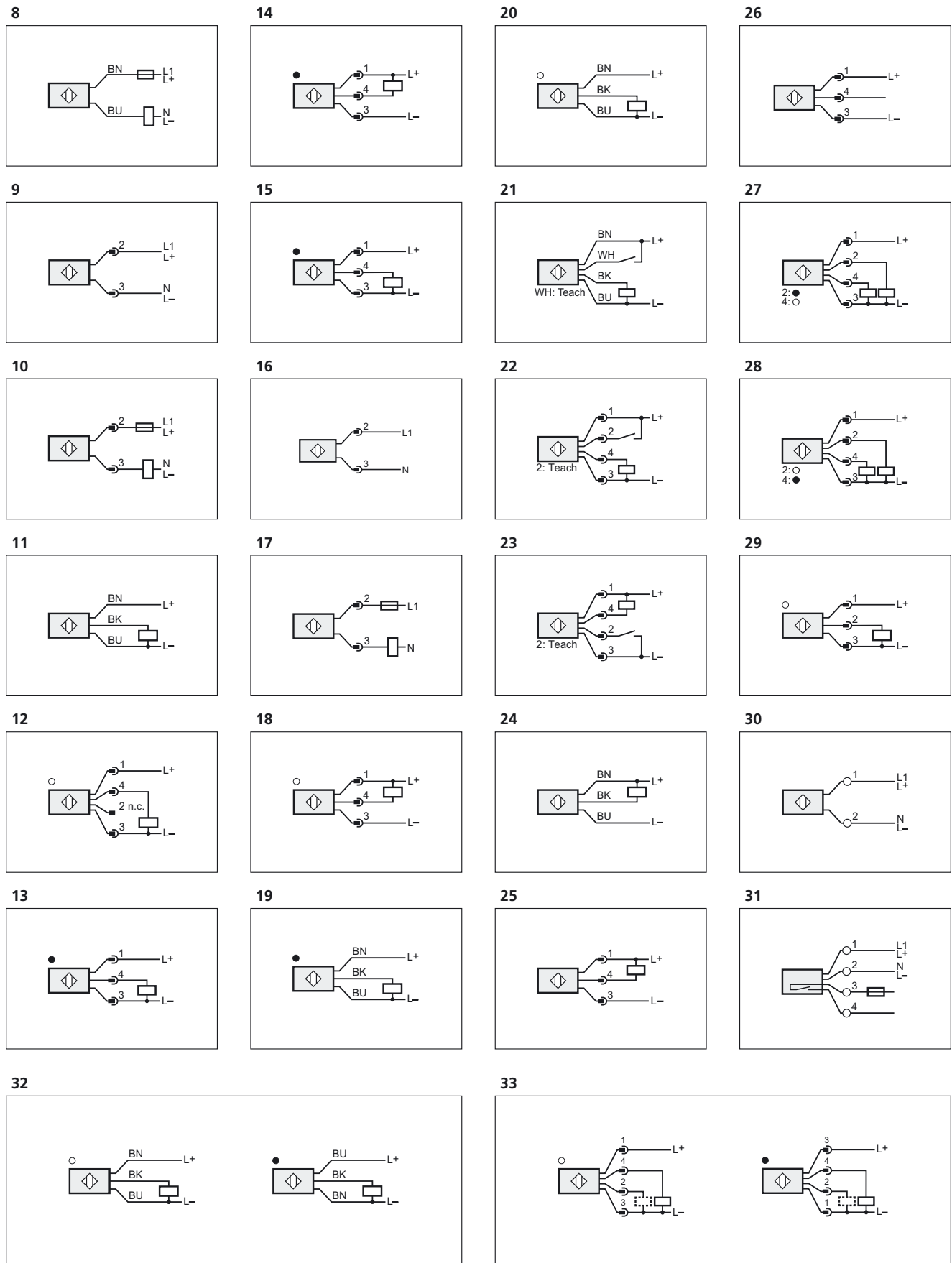

2: function check

Wiring diagrams

34

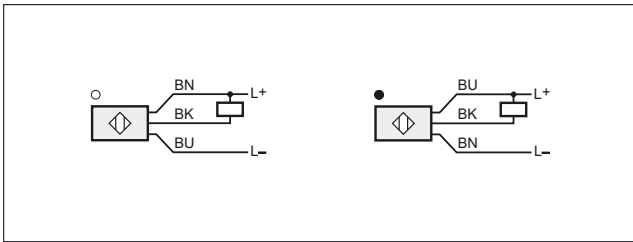

36

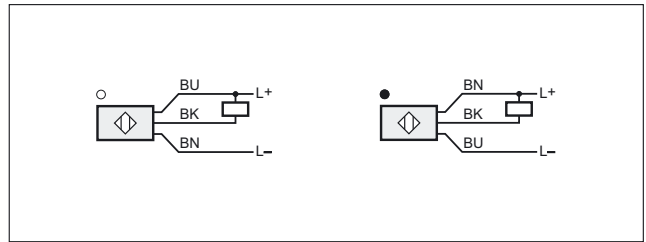

35

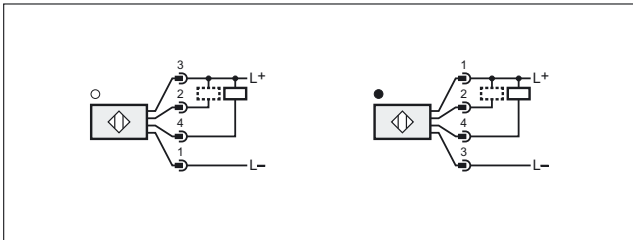

2: function check

37

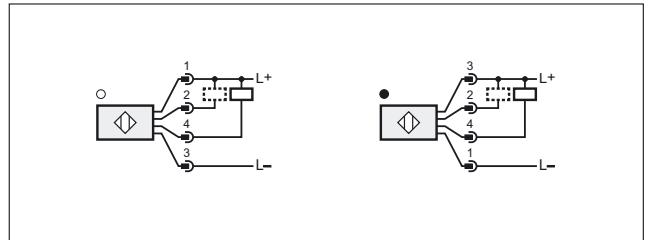

2: function check

Scale drawings / drawing no. – CAD download: www.ifm.com

1

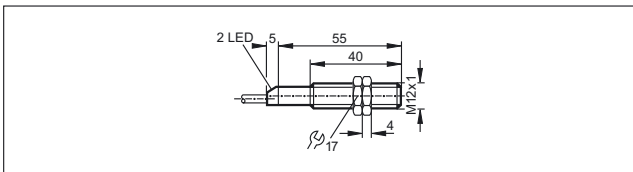

2

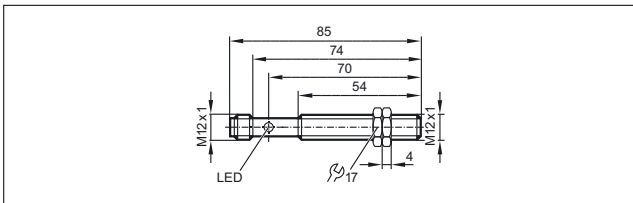

3

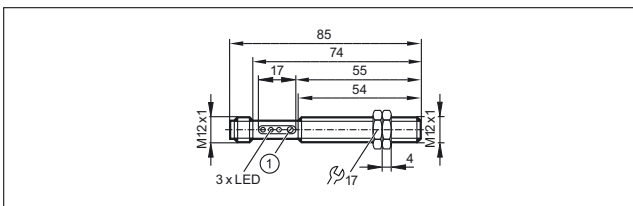

1: potentiometer

4

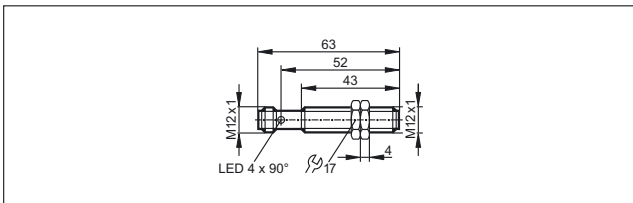

5

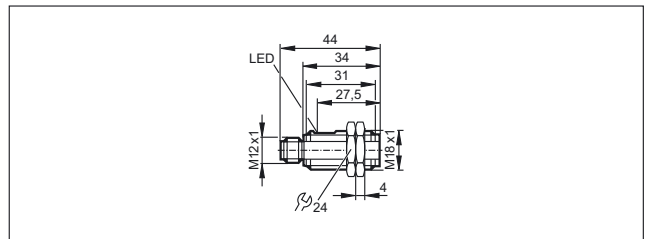

6

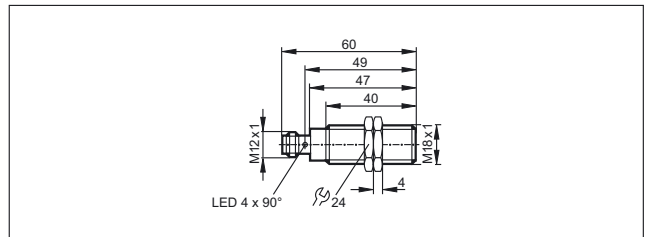

7

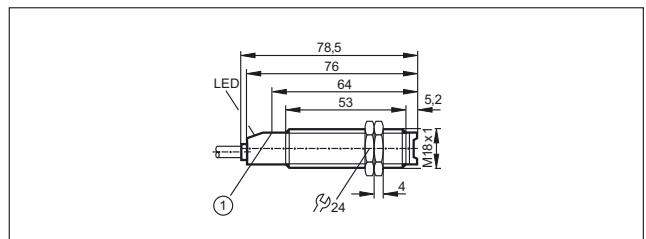

1: pushbutton

Scale drawings / drawing no. – CAD download: www.ifm.com

8

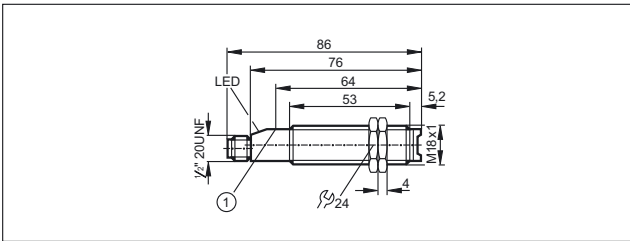

1: pushbutton

9

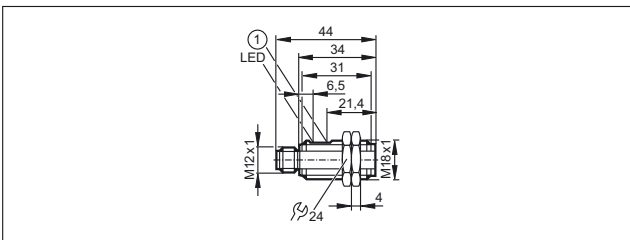

1: potentiometer

10

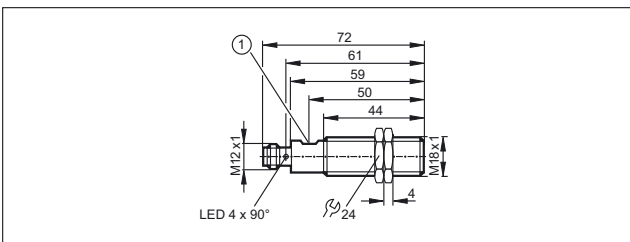

1: potentiometer

11

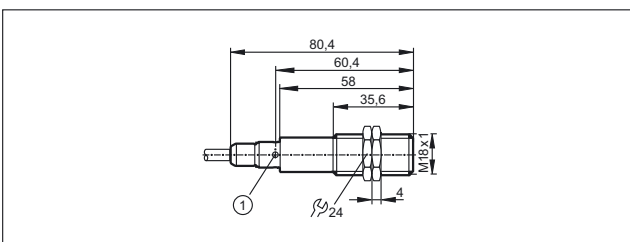

1: LED 4 x 90°

12

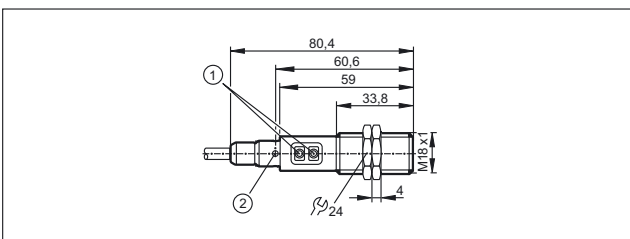

1: Programming buttons, 2: LED 4 x 90°

13

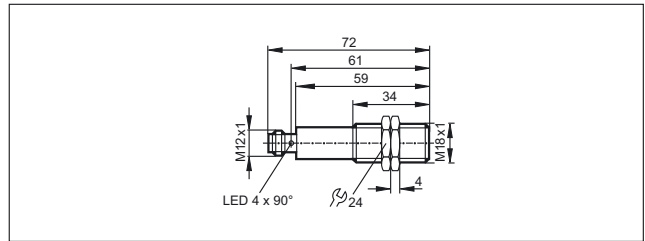

14

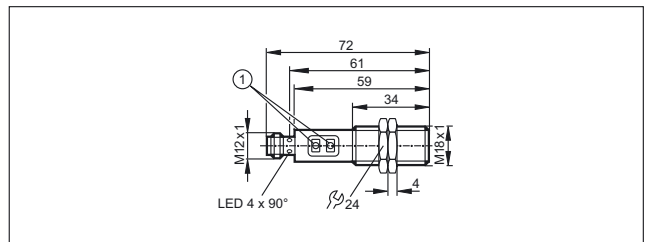

1: Programming buttons

15

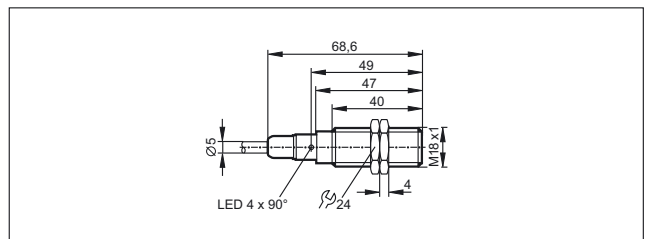

16

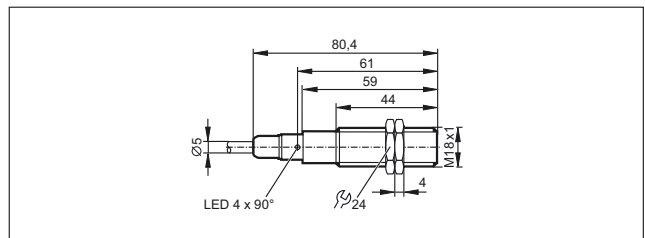

17

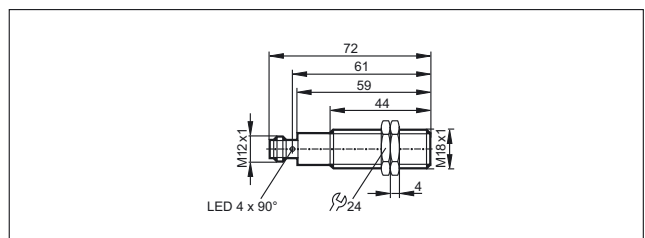

18

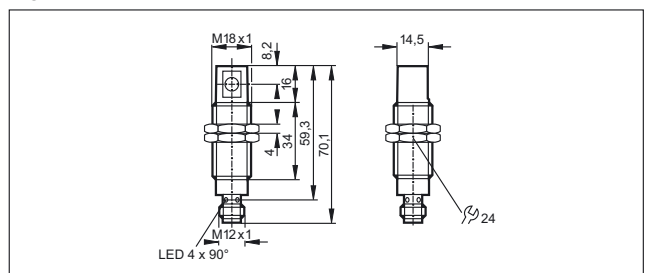

Scale drawings / drawing no. – CAD download: www.ifm.com

19

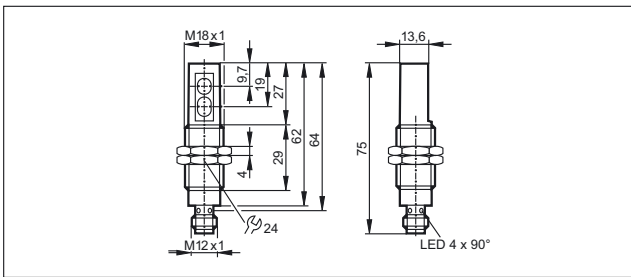

20

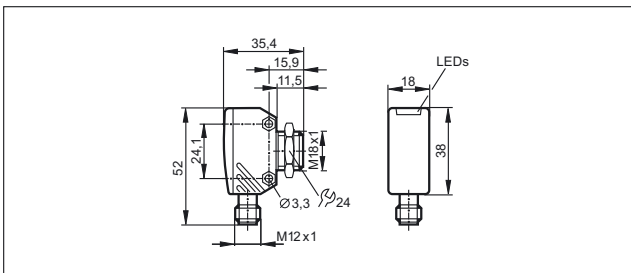

21

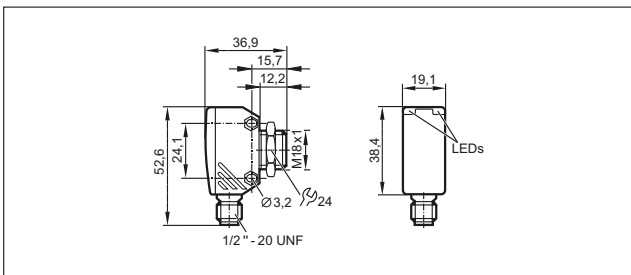

22

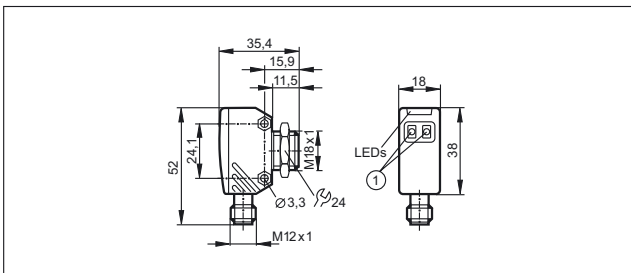

1: setting pushbuttons

23

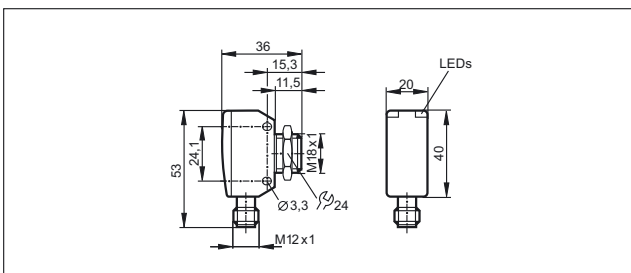

24

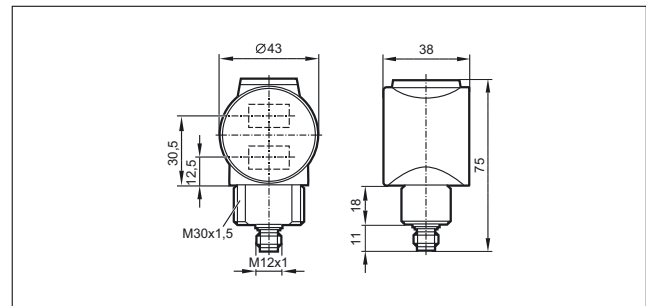

1: potentiometer

25

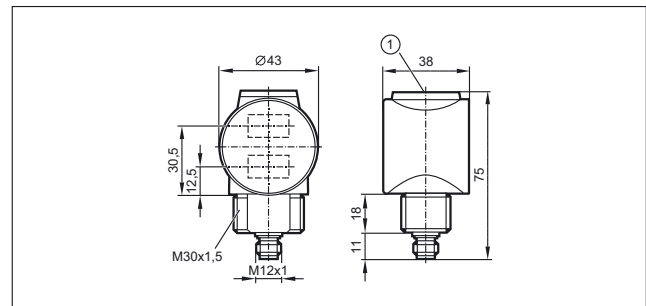

1:: potentiometer

26

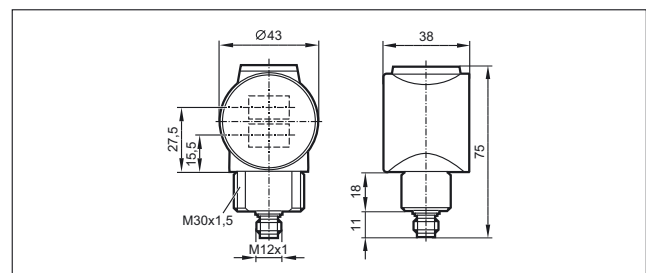

27

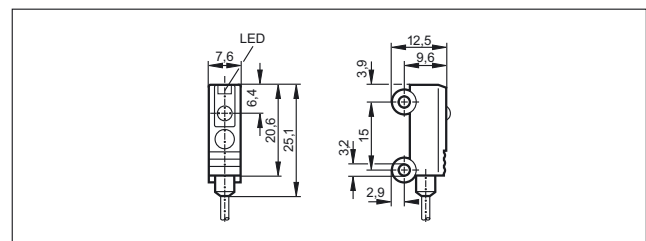

28

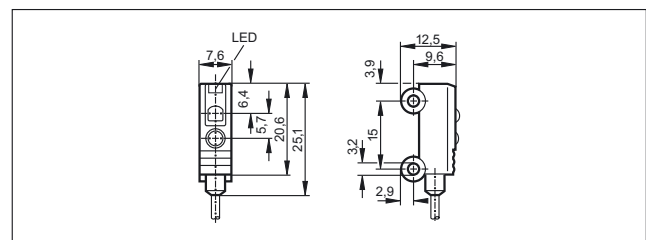

Scale drawings / drawing no. – CAD download: www.ifm.com

29

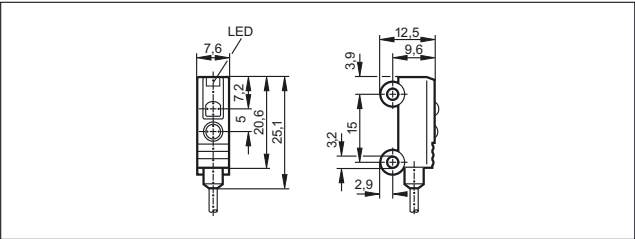

30

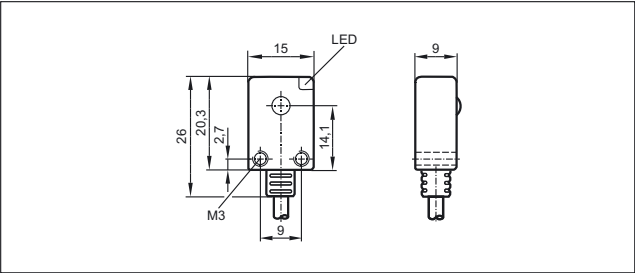

31

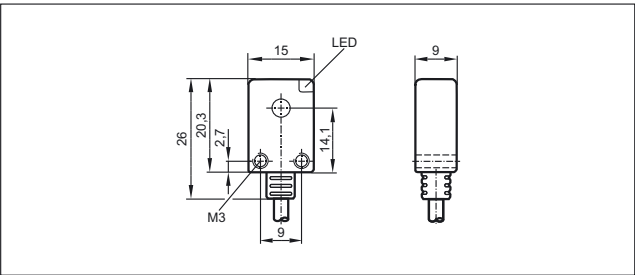

32

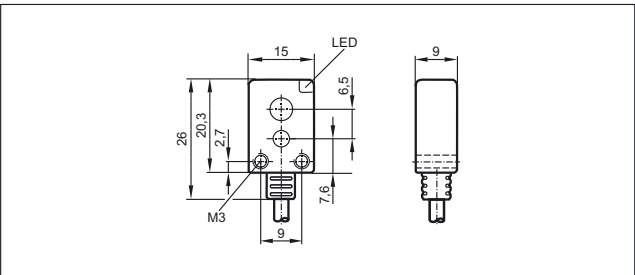

33

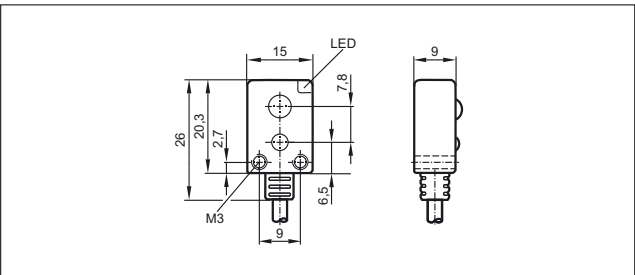

34

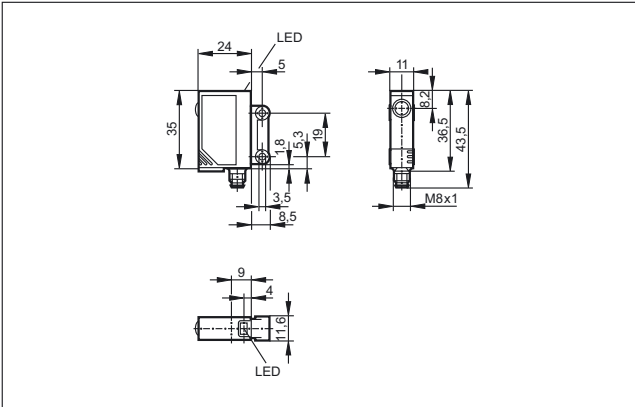

35

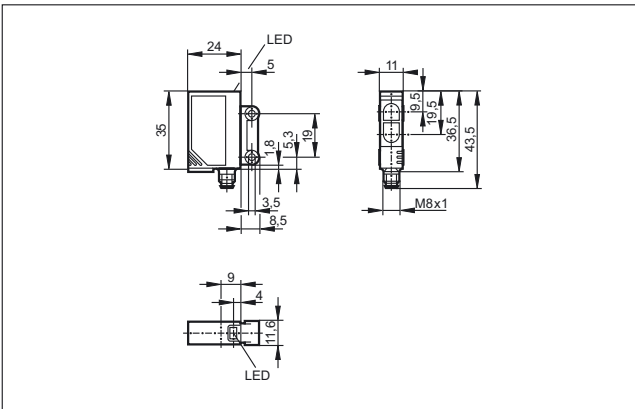

36

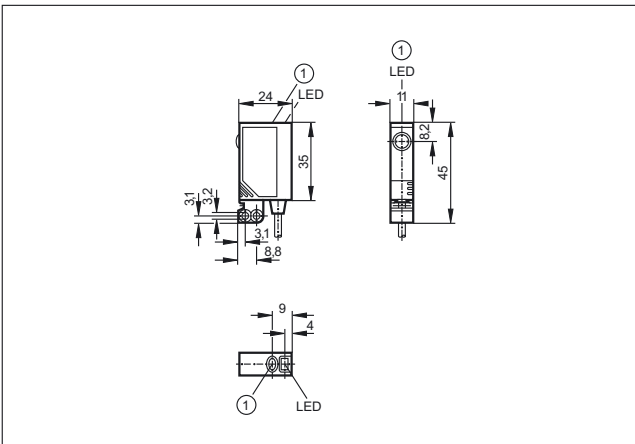

1: pushbutton

Scale drawings / drawing no. – CAD download: www.ifm.com

37

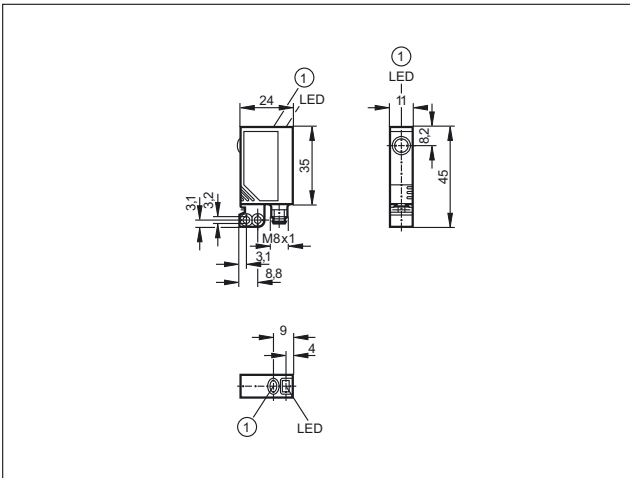

1: pushbutton

40

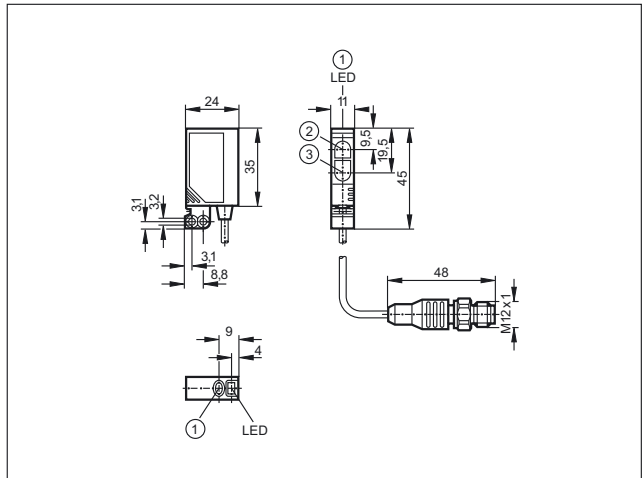

1: pushbutton, 2: Receiver, 3: Transmitter

38

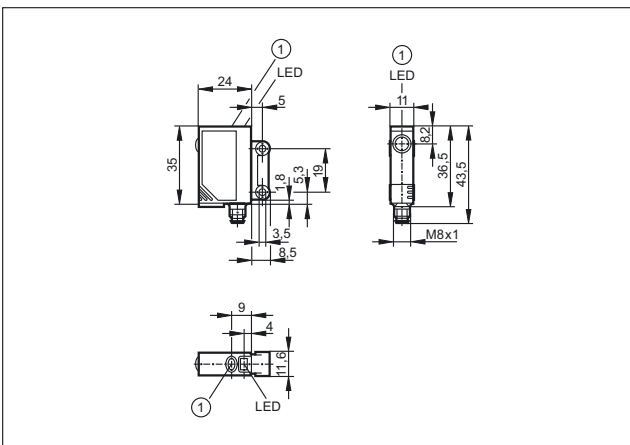

1: pushbutton

41

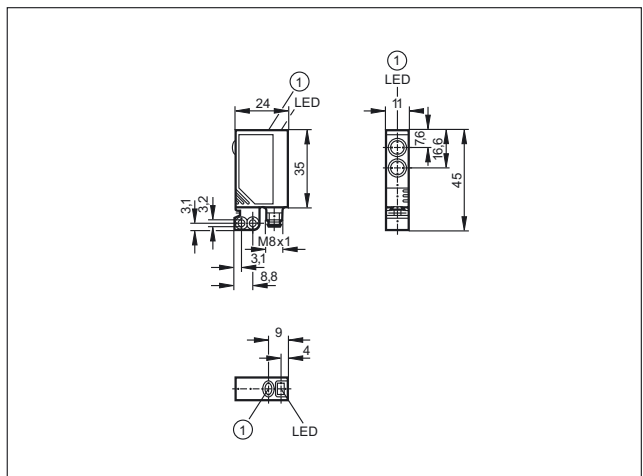

1: pushbutton

39

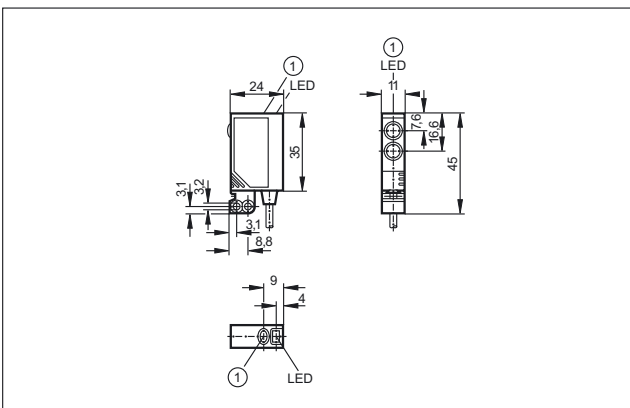

1: pushbutton

42

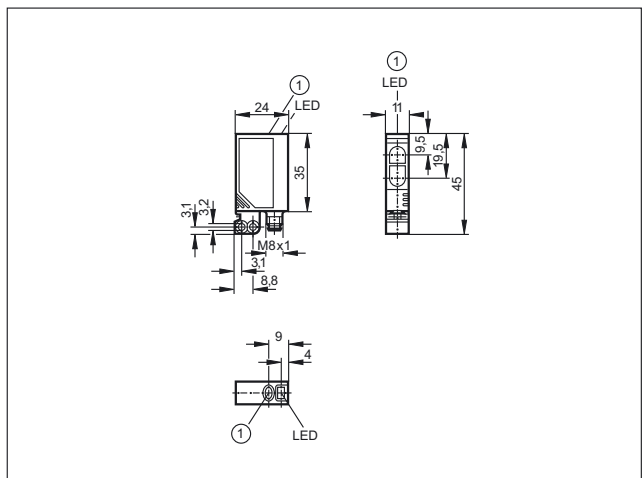

1: pushbutton

Scale drawings / drawing no. – CAD download: www.ifm.com

43

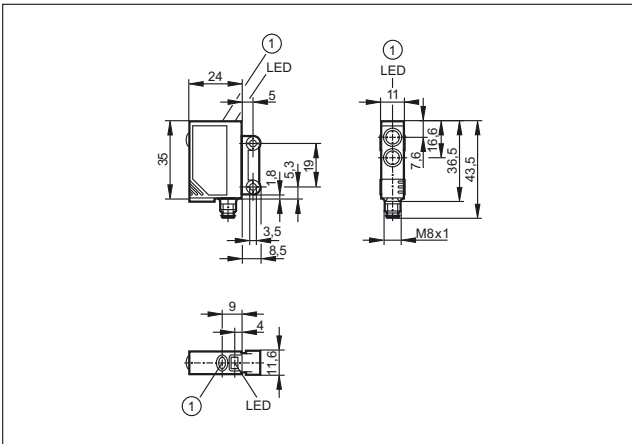

1: pushbutton

44

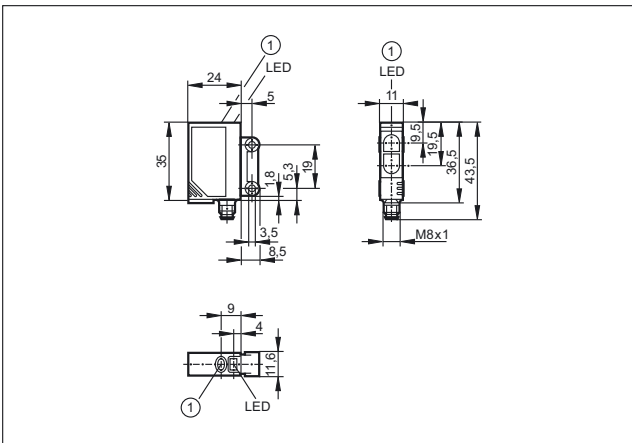

1: pushbutton

45

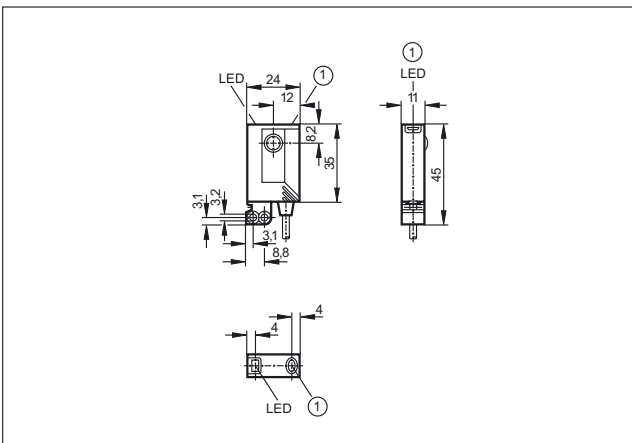

1: pushbutton

46

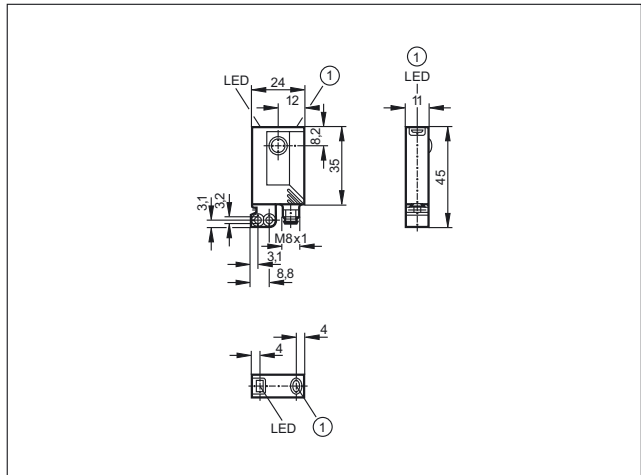

1: pushbutton

47

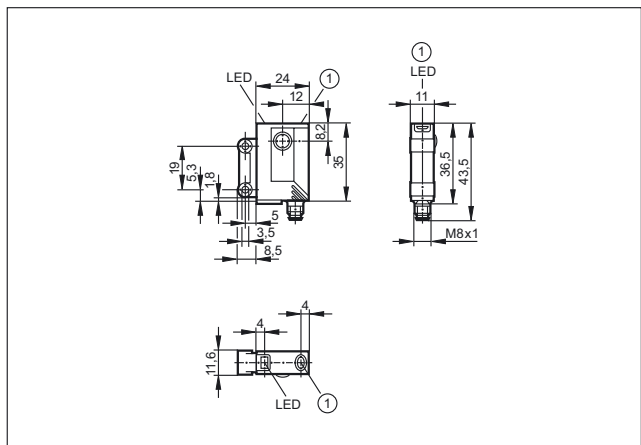

1: pushbutton

48

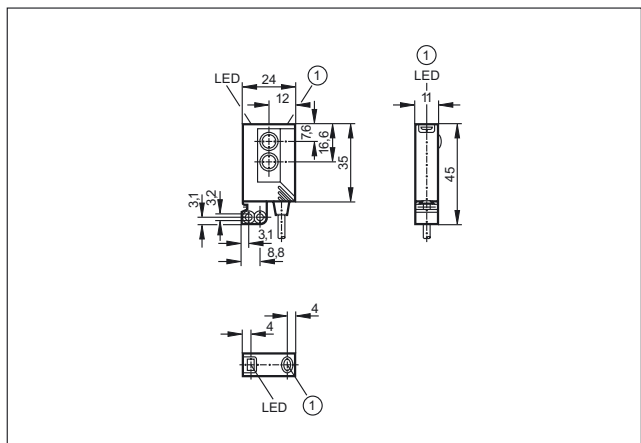

1: pushbutton

Scale drawings / drawing no. – CAD download: www.ifm.com

49

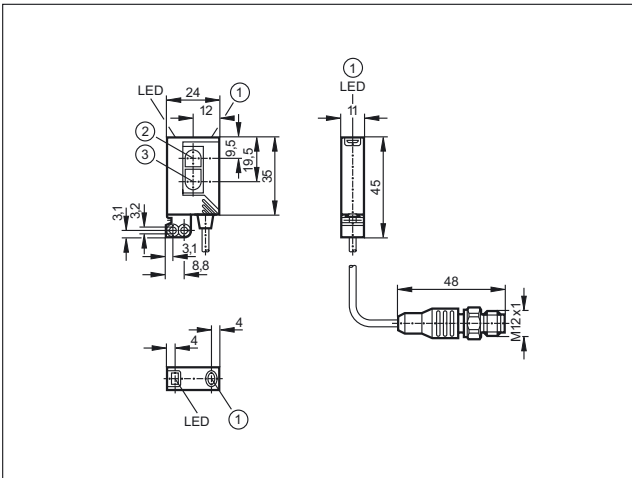

1: pushbutton, 2: Receiver, 3: Transmitter

50

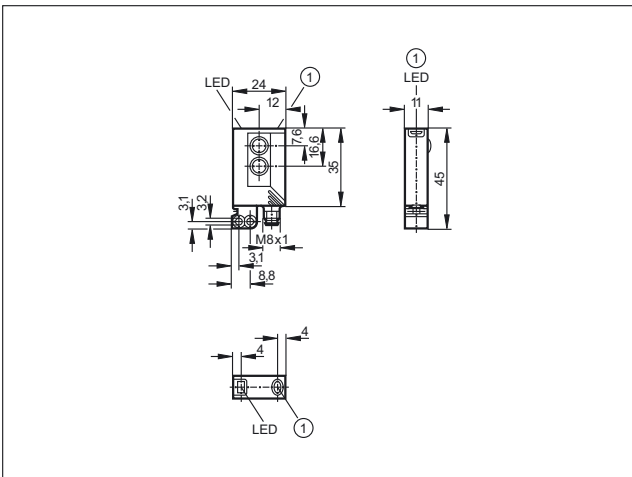

1: pushbutton

51

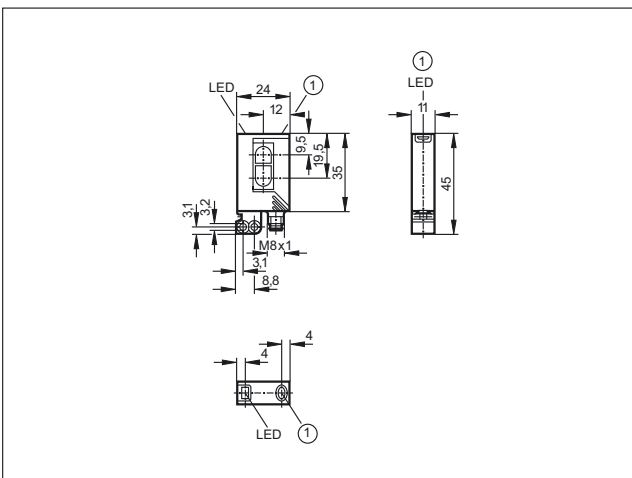

1: pushbutton

52

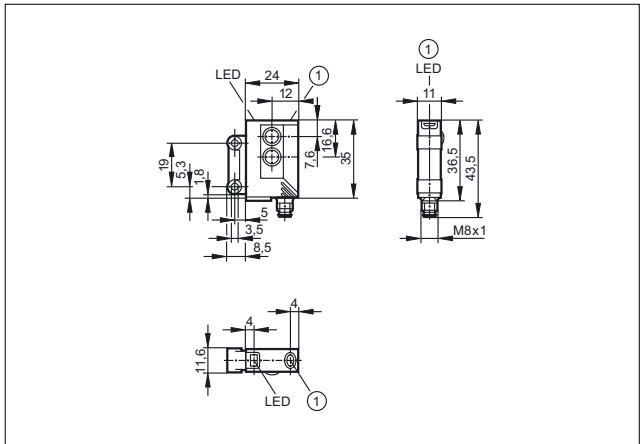

1: pushbutton

53

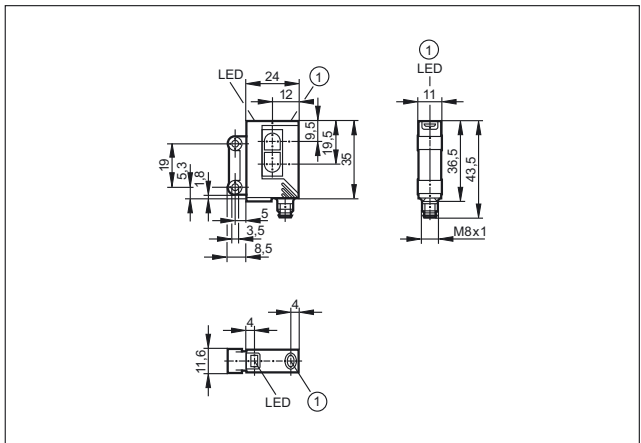

1: pushbutton

54

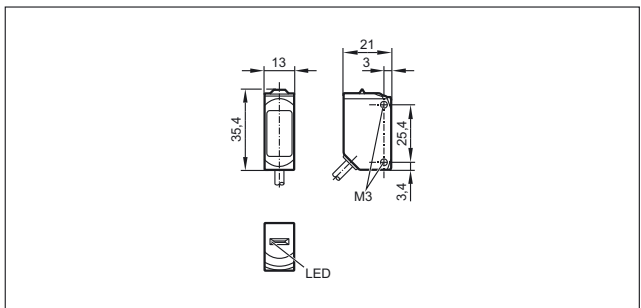

55

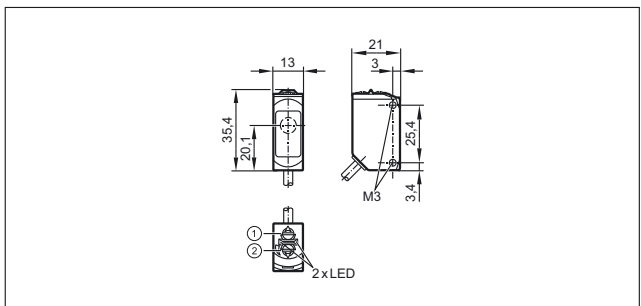

Scale drawings / drawing no. – CAD download: www.ifm.com

56

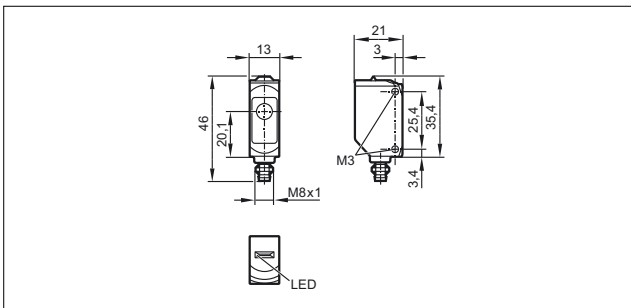

61

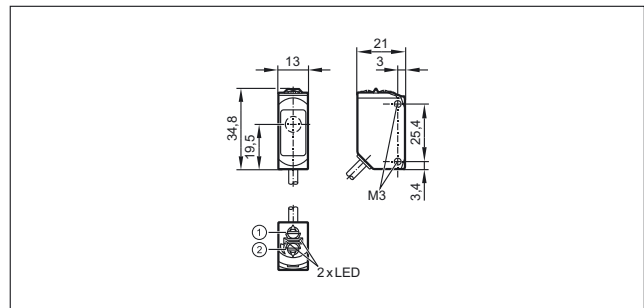

1:: output function switch, 2:: potentiometer sensitivity

57

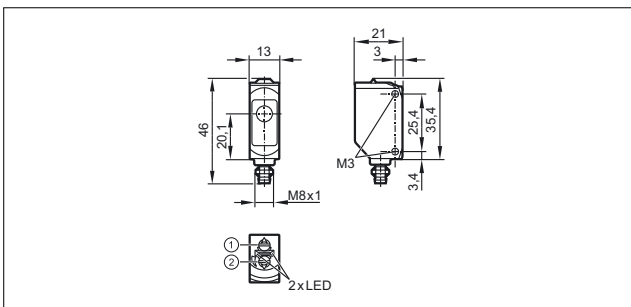

62

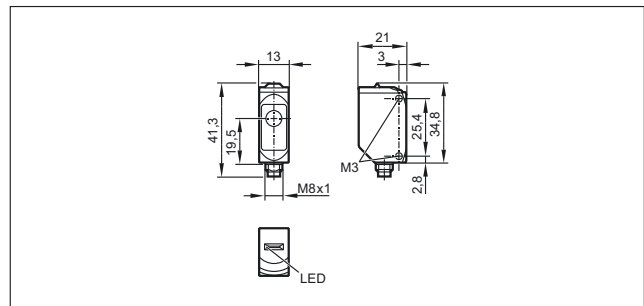

58

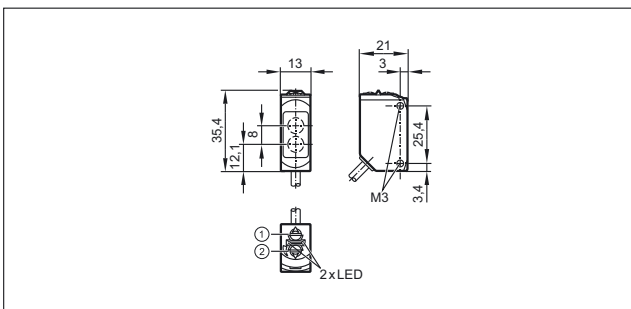

63

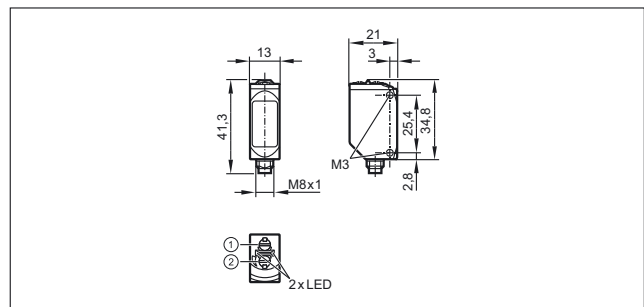

1:: output function switch, 2:: potentiometer sensitivity

59

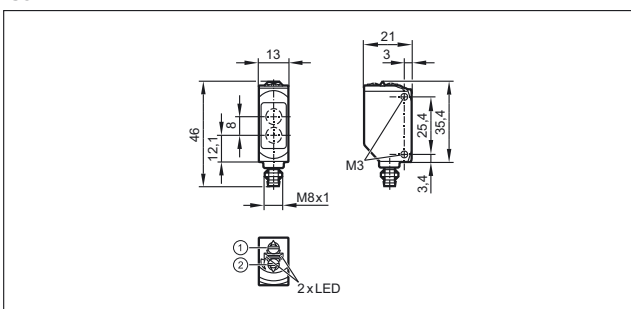

64

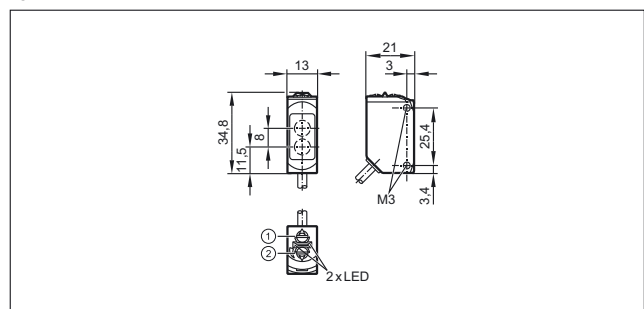

60

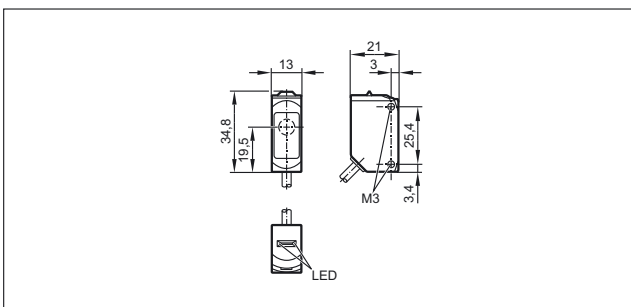

65

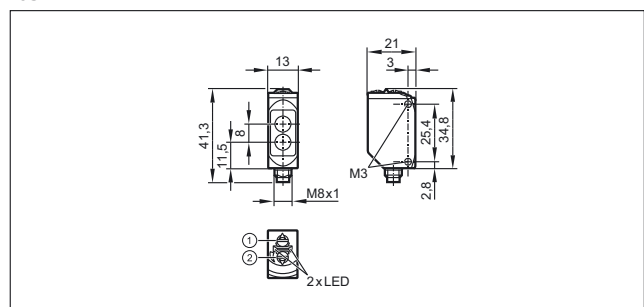

Scale drawings / drawing no. – CAD download: www.ifm.com

66

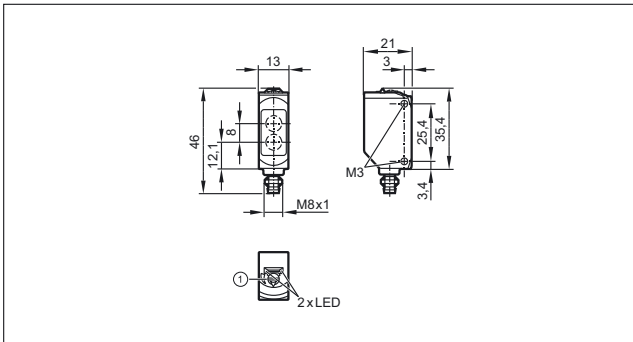

1: potentiometer sensitivity

67

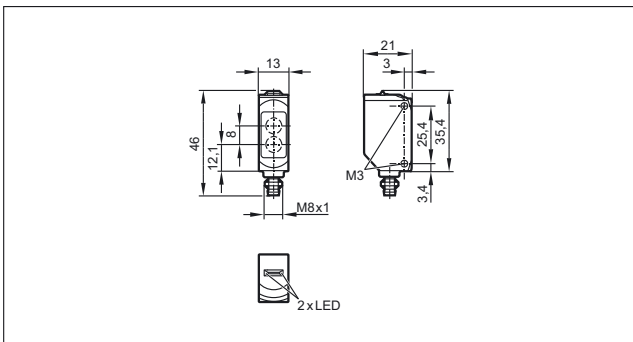

1: potentiometer sensitivity

69

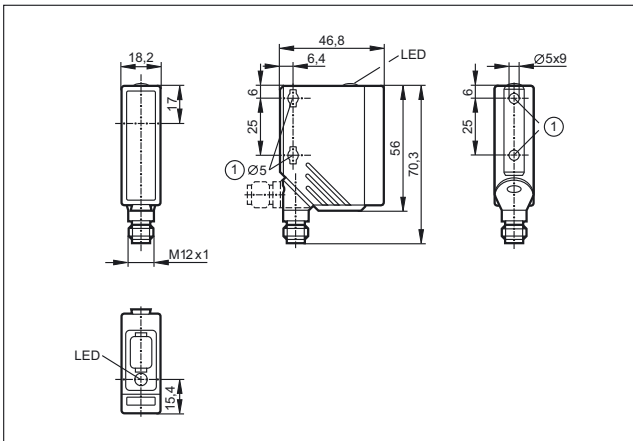

1: When a M5 mounting screw is used, the max. tightening torque is 2 Nm.

70

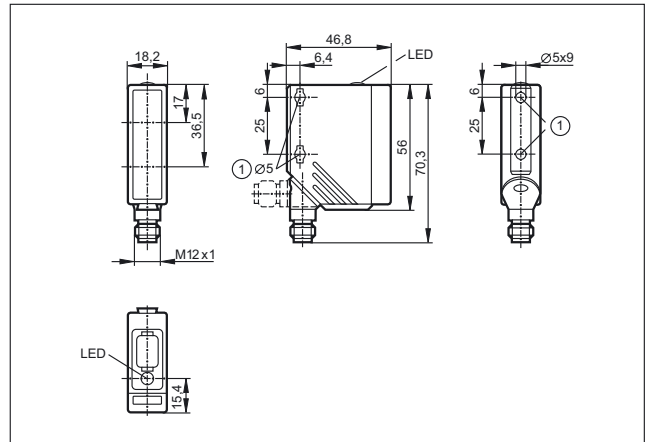

1: When a M5 mounting screw is used, the max. tightening torque is 2 Nm.

71

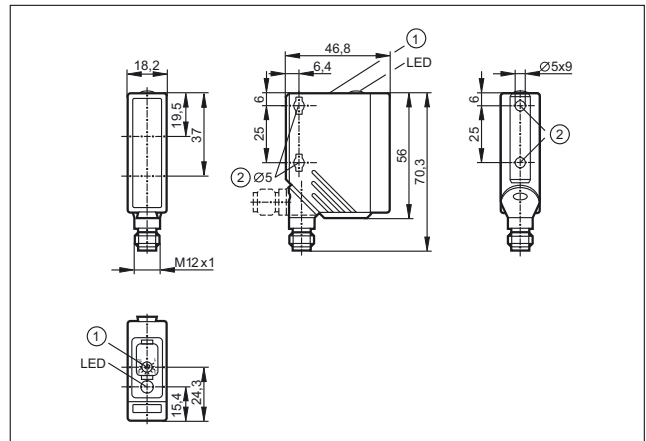

1: potentiometer, 2: When a M5 mounting screw is used, the max. tightening torque is 2 Nm.

72

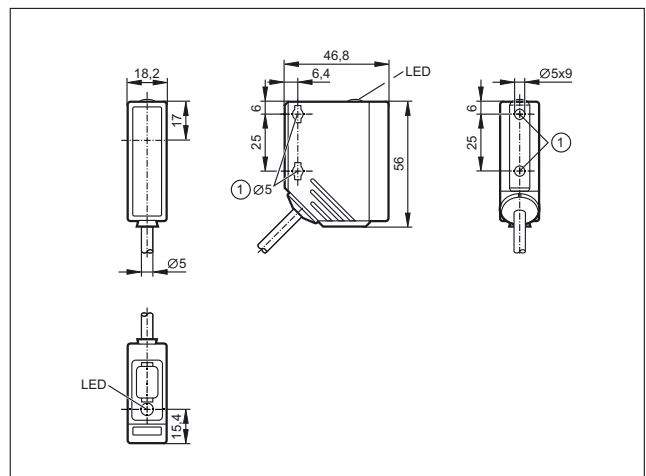

1: When a M5 mounting screw is used, the max. tightening torque is 2 Nm.

Scale drawings / drawing no. – CAD download: www.ifm.com

73

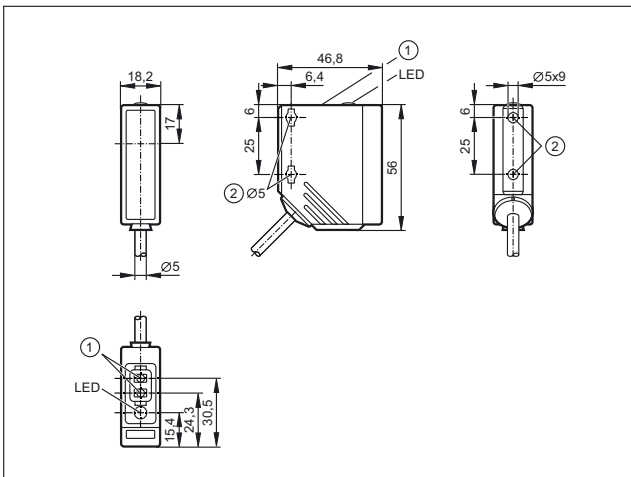

1: Programming buttons, 2: When a M5 mounting screw is used, the max. tightening torque is 2 Nm.

74

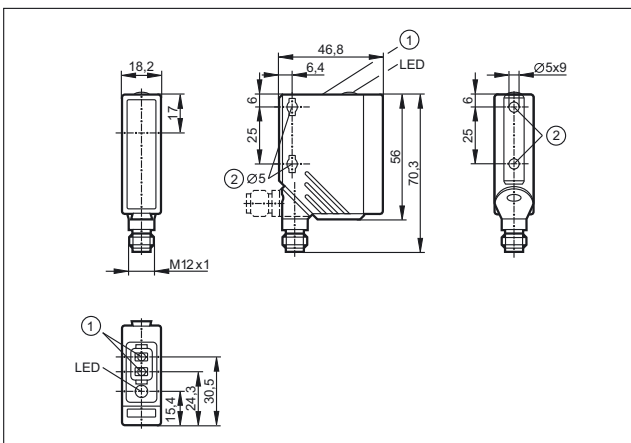

1: Programming buttons, 2: When a M5 mounting screw is used, the max. tightening torque is 2 Nm.

75

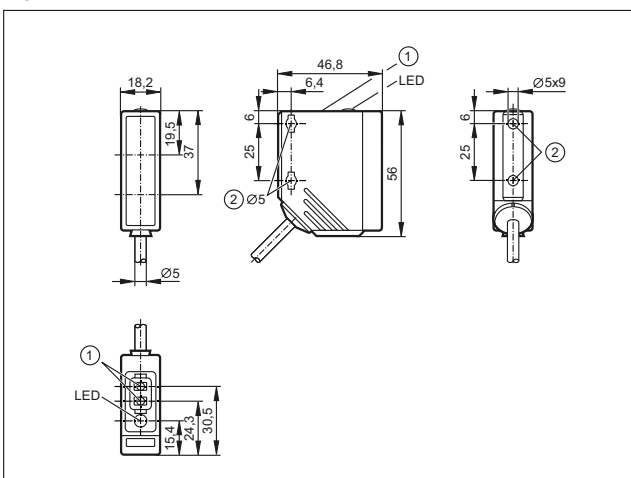

1: Programming buttons, 2: When a M5 mounting screw is used, the max. tightening torque is 2 Nm.

76

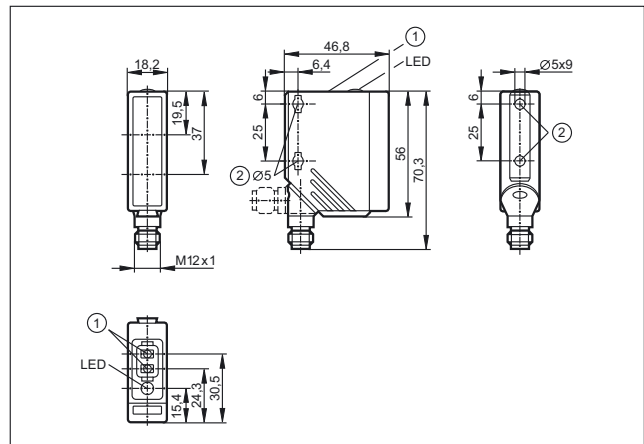

1: Programming buttons, 2: When a M5 mounting screw is used, the max. tightening torque is 2 Nm.

77

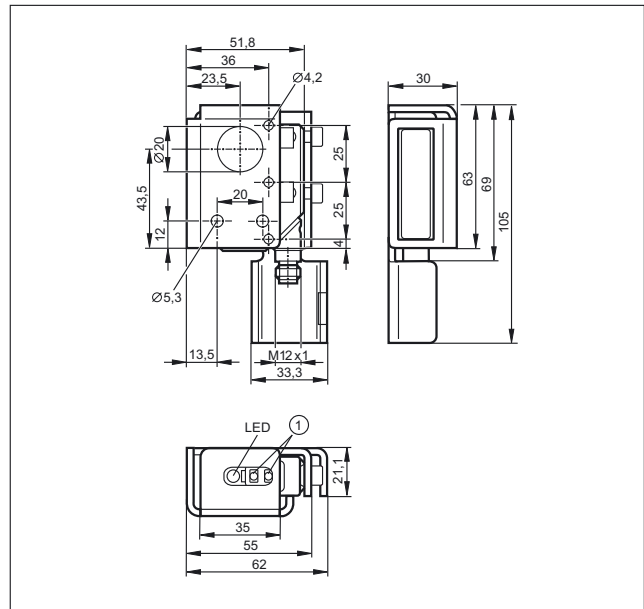

1: Programming buttons

78

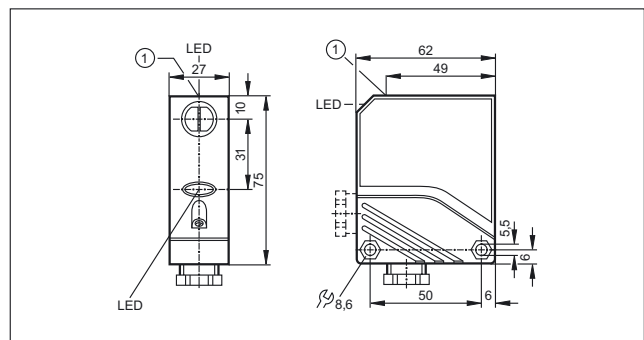

1: pushbutton

Scale drawings / drawing no. – CAD download: www.ifm.com

79

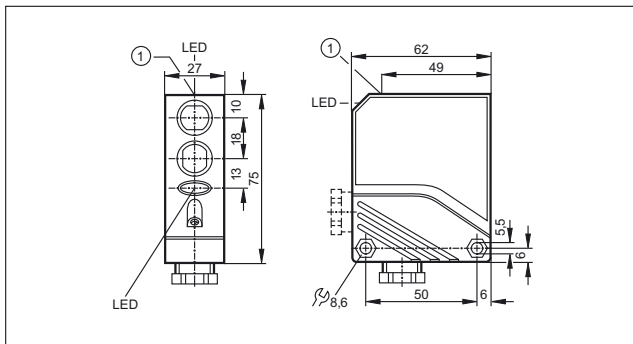

1: pushbutton

80

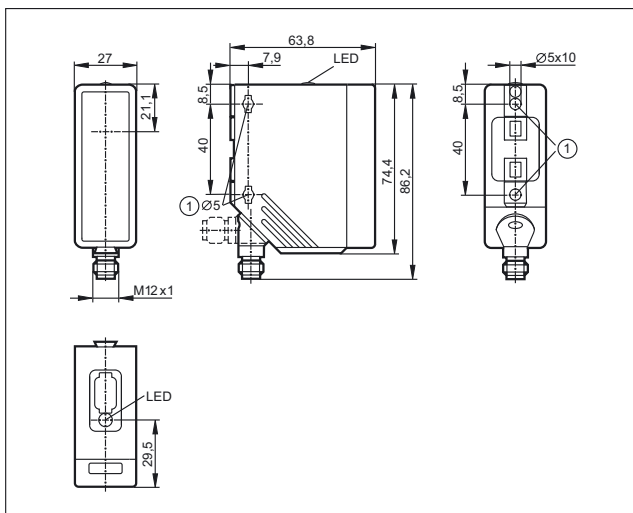

1: When a M5 mounting screw is used, the max. tightening torque is 2 Nm.

81

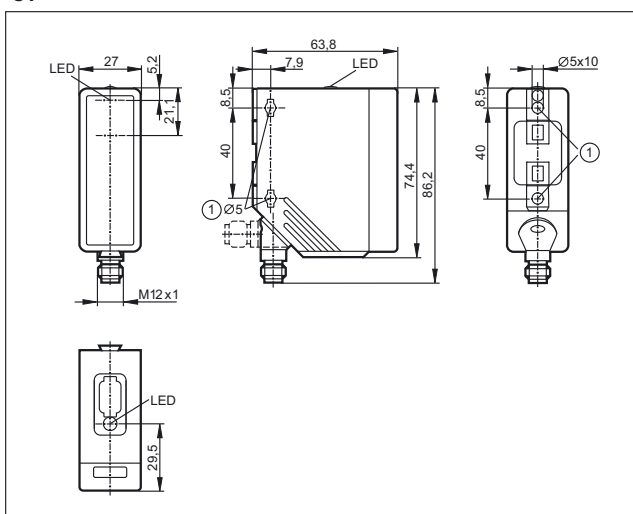

1: When a M5 mounting screw is used, the max. tightening torque is 2 Nm.

82

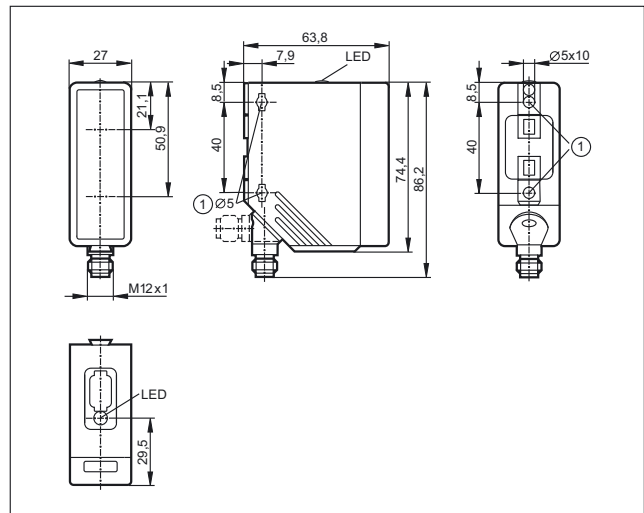

1: When a M5 mounting screw is used, the max. tightening torque is 2 Nm.

83

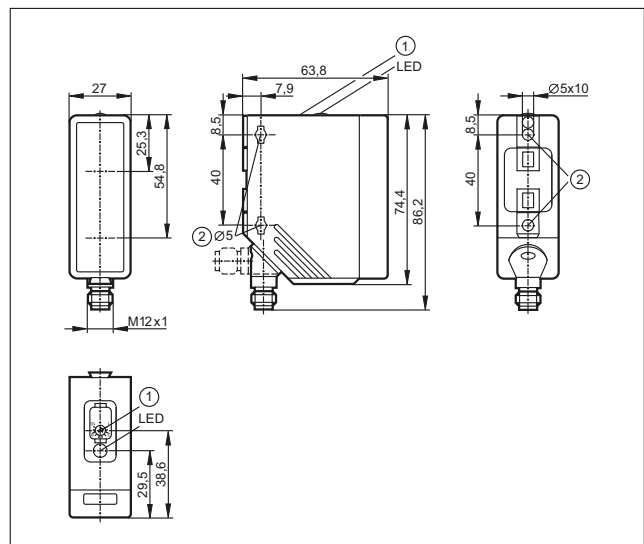

1: potentiometer, 2: When a M5 mounting screw is used, the max. tightening torque is 2 Nm.

Scale drawings / drawing no. – CAD download: www.ifm.com

84

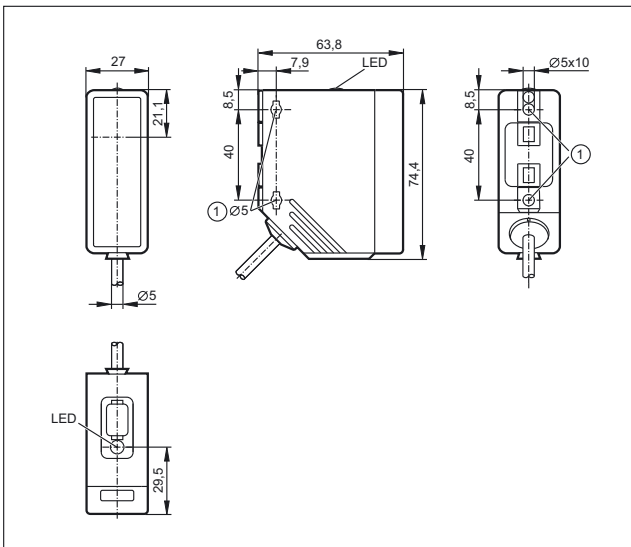

1: When a M5 mounting screw is used, the max. tightening torque is 2 Nm.

85

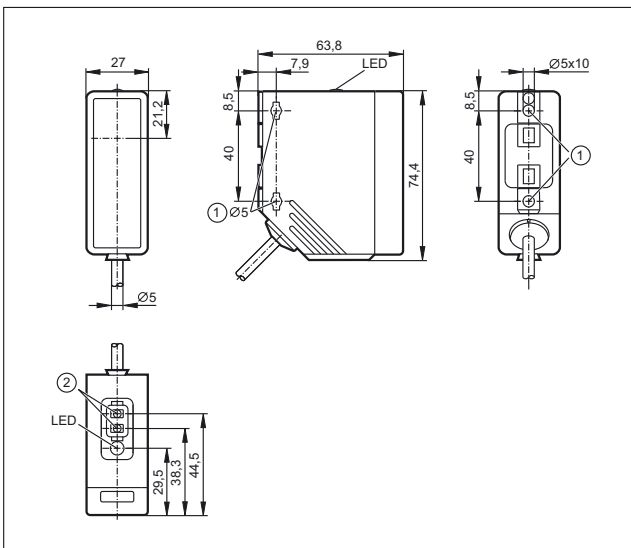

1: When a M5 mounting screw is used, the max. tightening torque is 2 Nm., 2: Programming buttons

86

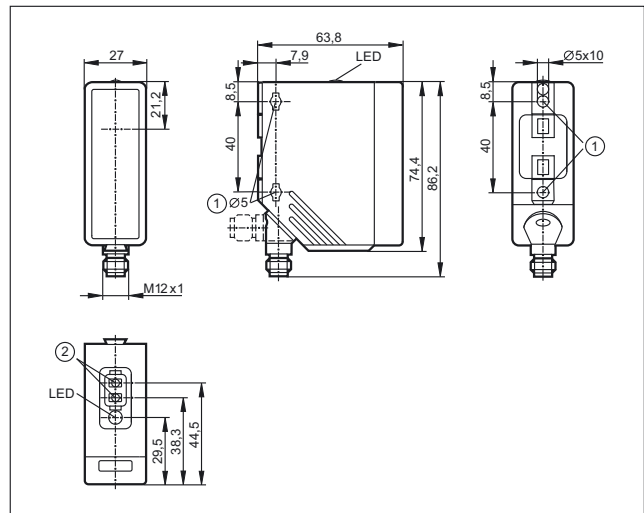

1: When a M5 mounting screw is used, the max. tightening torque is 2 Nm., 2: Programming buttons

87

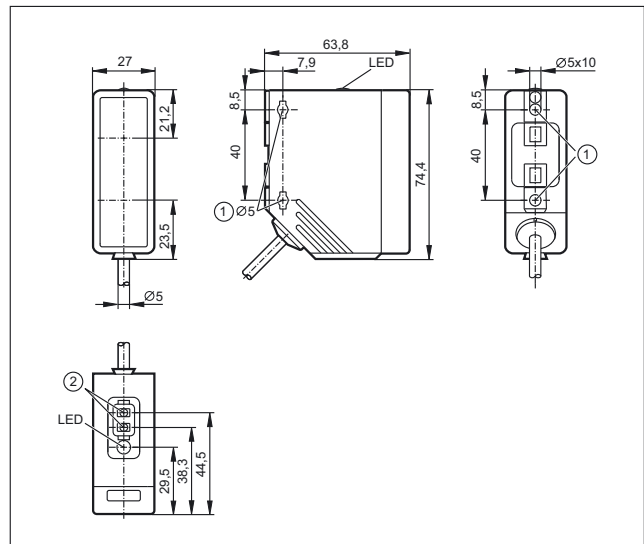

1: When a M5 mounting screw is used, the max. tightening torque is 2 Nm., 2: Programming buttons

88

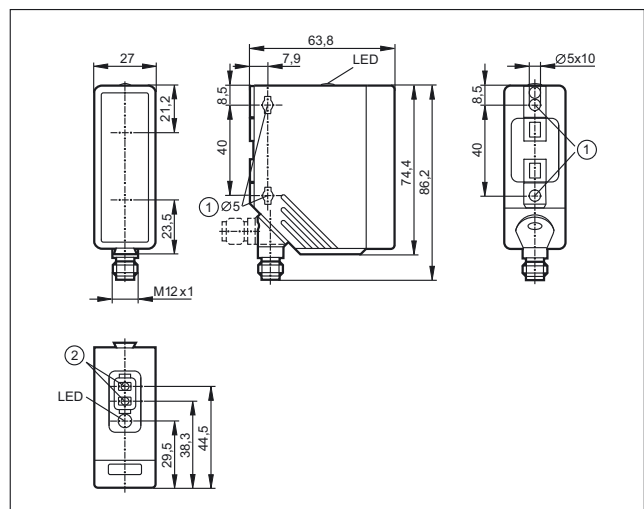

1: When a M5 mounting screw is used, the max. tightening torque is 2 Nm., 2: Programming buttons

Scale drawings / drawing no. – CAD download: www.ifm.com

89

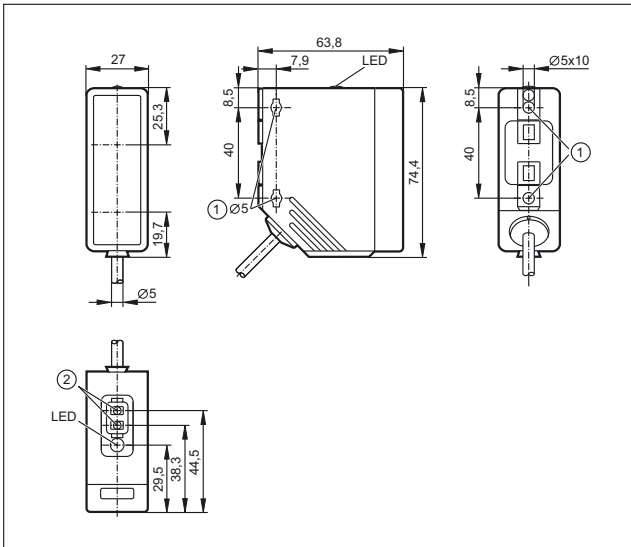

1: When a M5 mounting screw is used, the max. tightening torque is 2 Nm., 2: Programming buttons

90

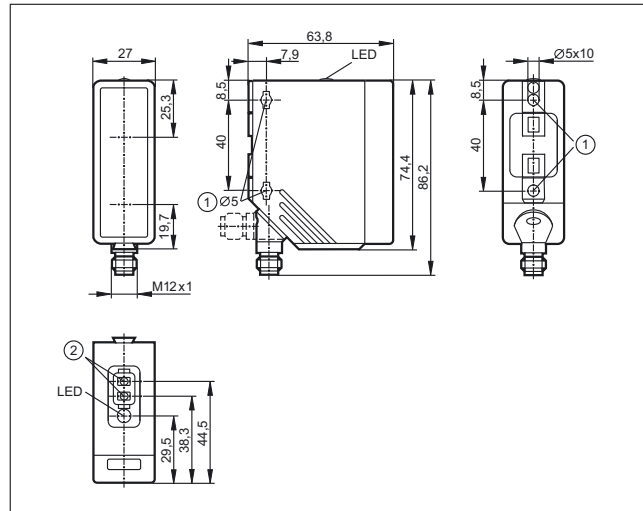

1: When a M5 mounting screw is used, the max. tightening torque is 2 Nm., 2: Programming buttons



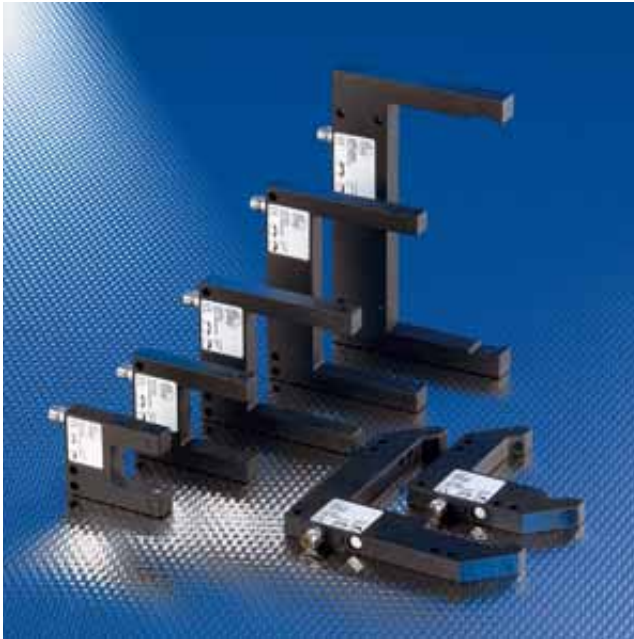

- Quick set-up: no need to align transmitter and receiver
- Fine and precise light beam across the whole fork width
- Metal housing reduces distortion
- Light-on / dark-on mode selectable via rotary switch
- Easy sensitivity setting via potentiometer

Optical fork and angle sensors

The optical fork and angle sensors are made from distortion-resistant diecast zinc and feature a high switching frequency. Applications are in particular part monitoring in feeding technology and handling systems. Further application examples are belt edge and double feed monitoring.

Easy to use

Sensitivity setting using the potentiometer and setting of light-on / dark-on mode using the rotary switch are simple and time-saving. No complex adjustment is required because transmitter and receiver are already aligned towards each other. Due to the fine and precise red light beam which is constant across the entire fork width, out-of-balance monitoring of shafts can also be carried out.



The optical fork and angle sensors are especially used for part monitoring in feeding technology and handling systems.

System overview	Page
Optical fork sensors	262
Laser fork sensors, laser class 2	263
Optical angle sensors	263
Wiring diagrams	263 - 264
Scale drawings / drawing no. – CAD download: www.ifm.com	264 - 265

Optical fork sensors

Type	Fork width (w) [mm]	Fork depth (d) [mm]	Smallest detectable object Ø [mm]	Switching frequency [Hz]	Output H = light-on D = dark-on	U _b [V]	Drawing no.	Order no.
------	------------------------	------------------------	--------------------------------------	-----------------------------	---------------------------------------	-----------------------	-------------	-----------

Optical fork sensor · Type OPU · M8 connector · metal · DC · Wiring diagram no. 3 · Connector groups 1, 2, 3, 72, 78, 120, 122

	10	17	0.3	10000	H/D PNP/NPN	10...35	1	OPU200
---	----	----	-----	-------	-------------	---------	---	---------------

Optical fork sensor · Type OPU · M8 connector · metal · DC · Wiring diagram no. 1 · Connector groups 1, 2, 3, 72, 78, 120, 122

	20	25	0.4	4000	H/D PNP	10...35	2	OPU201
---	----	----	-----	------	---------	---------	---	---------------

	30	35	0.5	4000	H/D PNP	10...35	3	OPU202
---	----	----	-----	------	---------	---------	---	---------------

	50	55	0.5	4000	H/D PNP	10...35	4	OPU203
---	----	----	-----	------	---------	---------	---	---------------

	80	55	0.5	4000	H/D PNP	10...35	5	OPU204
---	----	----	-----	------	---------	---------	---	---------------

	120	60	0.8	2000	H/D PNP	10...35	6	OPU205
---	-----	----	-----	------	---------	---------	---	---------------

Optical fork sensor · Type OPU · M8 connector · metal · DC · Wiring diagram no. 2 · Connector groups 1, 3, 72, 78, 120

	20	25	0.4	4000	H/D NPN	10...35	2	OPU207
---	----	----	-----	------	---------	---------	---	---------------

	30	35	0.5	4000	H/D NPN	10...35	3	OPU208
---	----	----	-----	------	---------	---------	---	---------------

	50	55	0.5	4000	H/D NPN	10...35	4	OPU209
---	----	----	-----	------	---------	---------	---	---------------



	80	55	0.5	4000	H/D NPN	10...35	5	OPU210
---	----	----	-----	------	---------	---------	---	---------------

	120	60	0.8	2000	H/D NPN	10...35	6	OPU211
---	-----	----	-----	------	---------	---------	---	---------------

Laser fork sensors, laser class 2

Type	Fork width (w) [mm]	Fork depth (d) [mm]	Smallest detectable object Ø [mm]	Switching frequency [Hz]	Output H = light-on D = dark-on	U _b [V]	Drawing no.	Order no.
------	------------------------	------------------------	--------------------------------------	-----------------------------	---------------------------------------	-----------------------	-------------	-----------



Optical fork sensor · Type OPU · M8 connector · metal · DC · Wiring diagram no. 1 · Connector groups 1, 2, 3, 72, 78, 120, 122

	30	35	0.05	3000	H/D PNP	10...30	7	OPU700
	50	55	0.05	3000	H/D PNP	10...30	8	OPU701
	80	55	0.05	3000	H/D PNP	10...30	9	OPU702



Optical angle sensors

Type	Side length (x, y) [mm]	Sensor width (z) [mm]	Smallest detectable object Ø [mm]	Switching frequency [Hz]	Output H = light-on D = dark-on	U _b [V]	Drawing no.	Order no.
------	----------------------------	--------------------------	--------------------------------------	-----------------------------	---------------------------------------	-----------------------	-------------	-----------

Optical angle sensor · Type OPL · M8 connector · metal · DC · Wiring diagram no. 1 · Connector groups 1, 2, 3, 72, 78, 120, 122

	50	60	0.5	4000	H/D PNP	10...35	10	OPL200
	80	100	0.7	4000	H/D PNP	10...35	11	OPL201

Optical angle sensor · Type OPL · M8 connector · metal · DC · Wiring diagram no. 2 · Connector groups 1, 3, 72, 78, 120

	50	60	0.5	4000	H/D NPN	10...35	10	OPL202
	80	100	0.7	4000	H/D NPN	10...35	11	OPL203

Wiring diagrams

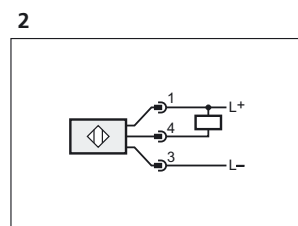
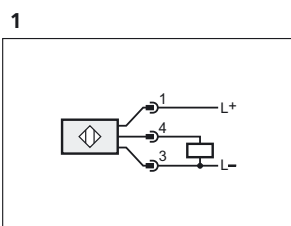

Scale drawings / drawing no. – CAD download: www.ifm.com

8

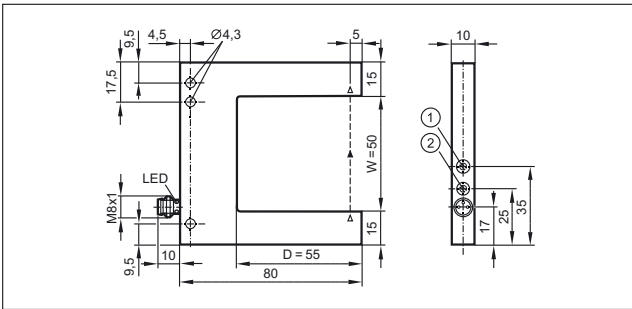

1: potentiometer sensitivity, 2: output function switch

9

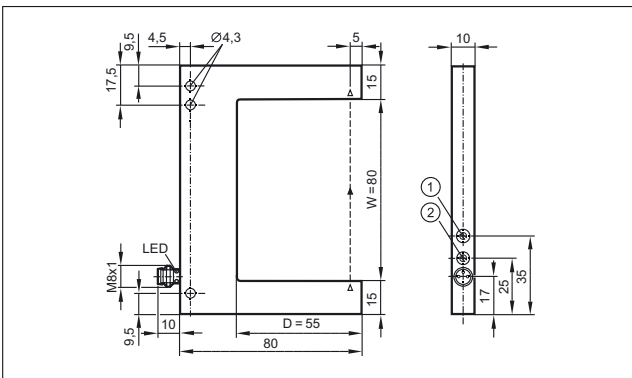

1: potentiometer sensitivity, 2: output function switch

10

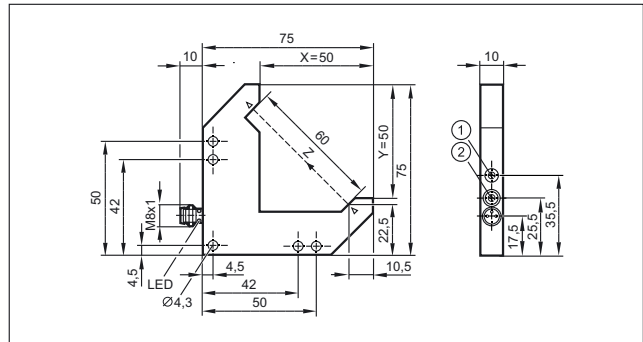

1: potentiometer sensitivity, 2: output function switch

11

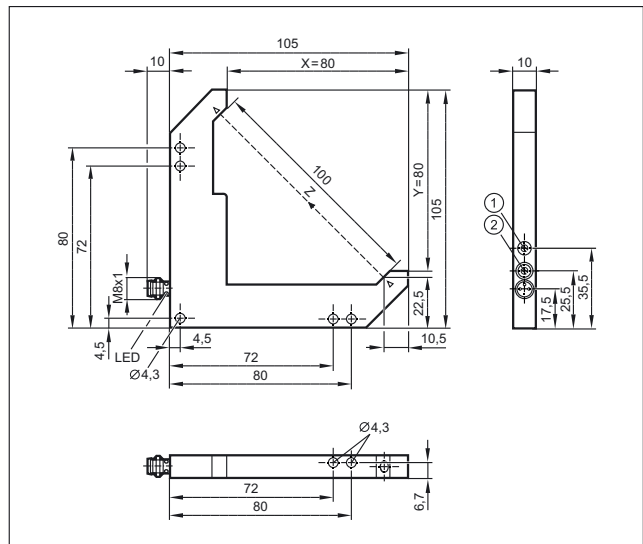

1: potentiometer sensitivity, 2: output function switch



- Laser sensors for detection of tiny objects
- Laser sensors for high power over long ranges
- Clearly visible red light for easy setting
- Easy pushbutton adjustment
- Accessories for robust mounting and fine adjustment

Laser sensors





Laser sensors are used where detection of small objects or precise positioning is required. Alternatively, where very high power is needed lasers are also of great benefit to cover longer distances or see through. Laser sensors are available as through-beam sensors, retro-reflective sensors or diffuse reflection sensors. Laser light consists of light waves of identical length which have a defined phase relation (coherence). This results in an important feature of laser systems, that is the almost parallel light beam. The small angle of divergence means long ranges can be achieved. The laser spot which is also clearly visible in daylight simplifies the alignment of the system.



Coherent: Laser sensors emit light of a defined wave length and the same phase position.

System overview	Page
Cylindrical OG housing (M18) Laser PerformanceLine, laser class 1	268
Rectangular housing OJ Laser PerformanceLine, lateral sensing face, laser class 1	268 - 269
Rectangular housing OJ Laser PerformanceLine, front sensing face, laser class 1	269 - 270
Rectangular housing O5 laser class 1	270 - 271
Rectangular housing O1 Laser PerformanceLine with background suppression, laser class 2	271
Prismatic reflector	271 - 272
Accessories OG housing	272
Accessories O5 housing	272 - 273
Accessories O1 housing	274
Accessories for system components	274 - 275
Cylindrical OI housing (M30) for optical distance measurement, laser class 2	275
Cylindrical OI housing (M30) for optical distance measurement, laser class 1	275 - 276
Rectangular housing O5 for optical distance measurement, laser class 2	276
Rectangular housing O1 for optical distance measurement, laser class 1	276
Rectangular housing O1 for optical distance measurement, laser class 2	277
Rectangular housing O1 Laser PerformanceLine with background suppression, laser class 2	277
Rectangular housing O1 for optical level measurement, laser class 2	277
Accessories OI design (M30)	278
Accessories O5 housing	278 - 279
Accessories O1 housing	279 - 280
Wiring diagrams	280
Scale drawings / drawing no. – CAD download: www.ifm.com	280 - 283

Cylindrical OG housing (M18) Laser PerformanceLine, laser class 1

Type	Operating principle	Range	Type of light	Spot Ø at max. range [mm]	Output H = light-on D = dark-on	Wiring diagr. no.	Draw- ing no.	Order no.
Through-beam sensor · M12 connector · 10...36 DC · high-grade stainless steel · IP65 / IP67 · Connector groups 8, 10, 18, 20, 120, 124, 126, 128, 157								
	Transmitter	2 m	Red	5	–	1	1	OGS701
	Transmitter	60 m	Red	312	–	1	1	OGS700
Through-beam sensor · M12 connector · 10...36 DC · high-grade stainless steel · IP65 / IP67 · Connector groups 8, 10, 11, 18, 20, 120, 124, 126, 128, 130, 157, 158								
	Receiver	2 m	Red	–	H/D PNP	2	2	OGE701
	Receiver	60 m	Red	–	H/D PNP	2	2	OGE700
Retro-reflective sensor · M12 connector · 10...36 DC · high-grade stainless steel · IP65 / IP67 · Connector groups 8, 10, 11, 18, 20, 120, 124, 126, 128, 130, 157, 158								
	Polarisation filter	0.2...2 m	Red	5	H/D PNP	2	2	OGP701
	Polarisation filter	0.2...15 m	Red	78	H/D PNP	2	2	OGP700
Diffuse reflection sensor · M12 connector · 10...36 DC · high-grade stainless steel · IP65 / IP67 · Connector groups 8, 10, 11, 18, 20, 120, 124, 126, 128, 130, 157, 158								
	Background suppression	20...200 mm	Red	1.2	H/D PNP	2	2	OGH700

Rectangular housing OJ Laser PerformanceLine, lateral sensing face, laser class 1



Type	Operating principle	Range	Type of light	Spot Ø at max. range [mm]	Output H = light-on D = dark-on	Wiring diagr. no.	Draw- ing no.	Order no.
Through-beam sensor · M8 connector · 10...30 DC · plastics · IP67 · Connector groups 4, 5, 74, 80, 124								
	Transmitter	1 m	Red	< 4	–	1	3	OJ5041
	Receiver	1 m	Red	–	H/D PNP	3	3	OJ5042
	Transmitter	15 m	Red	< 24	–	1	3	OJ5038
	Receiver	15 m	Red	–	H/D PNP	3	3	OJ5039

Type	Operating principle	Range	Type of light	Spot Ø at max. range [mm]	Output H = light-on D = dark-on	Wiring diagr. no.	Draw- ing no.	Order no.
------	---------------------	-------	---------------	---------------------------	---------------------------------------	-------------------------	---------------------	--------------



Through-beam sensor · M8 connector · 10...30 DC · plastics · IP67 · Connector groups 4, 5, 74, 80, 124

	Transmitter	1 m	Red	< 4	–	1	4	OJ5141
	Receiver	1 m	Red	–	H/D PNP	3	4	OJ5142
	Transmitter	15 m	Red	< 24	–	1	4	OJ5138
	Receiver	15 m	Red	–	H/D PNP	3	4	OJ5139

Retro-reflective sensor · M8 connector · 10...30 DC · plastics · IP67 · Connector groups 4, 5, 74, 80, 124

	Polarisation filter	8 m	Red	< 12	H/D PNP	3	3	OJ5036
	Polarisation filter	8 m	Red	< 12	H/D PNP	3	4	OJ5136

Diffuse reflection sensor · M8 connector · 10...30 DC · plastics · IP67 · Connector groups 4, 5, 74, 80, 124

	Background suppression	7...150 mm	Red	0.8	H/D PNP	3	5	OJ5058
	Background suppression	15...200 mm	Red	2x1	H/D PNP	3	6	OJ5054
	Background suppression	7...150 mm	Red	0.8	H/D PNP	3	7	OJ5158
	Background suppression	15...200 mm	Red	2x1	H/D PNP	3	8	OJ5154

Rectangular housing OJ Laser PerformanceLine, front sensing face, laser class 1

Type	Operating principle	Range	Type of light	Spot Ø at max. range [mm]	Output H = light-on D = dark-on	Wiring diagr. no.	Draw- ing no.	Order no.
------	---------------------	-------	---------------	---------------------------	---------------------------------------	-------------------------	---------------------	--------------



Through-beam sensor · M8 connector · 10...30 DC · plastics · IP67 · Connector groups 4, 5, 74, 80, 124

	Transmitter	1 m	Red	< 4	–	1	9	OJ5019
	Receiver	1 m	Red	–	H/D PNP	3	9	OJ5020



Position sensors

Type	Operating principle	Range	Type of light	Spot Ø at max. range [mm]	Output H = light-on D = dark-on	Wiring diag. no.	Draw- ing no.	Order no.
------	---------------------	-------	---------------	---------------------------	---------------------------------------	------------------------	---------------------	--------------



Through-beam sensor · M8 connector · 10...30 DC · plastics · IP67 · Connector groups 4, 5, 74, 80, 124

	Transmitter	15 m	Red	< 24	–	1	9	OJ5016
	Receiver	15 m	Red	–	H/D PNP	3	9	OJ5017
	Transmitter	15 m	Red	< 24	–	1	10	OJ5116
	Receiver	15 m	Red	–	H/D PNP	3	10	OJ5117

Retro-reflective sensor · M8 connector · 10...30 DC · plastics · IP67 · Connector groups 4, 5, 74, 80, 124

	Polarisation filter	8 m	Red	< 12	H/D PNP	3	9	OJ5014
	Polarisation filter	8 m	Red	< 12	H/D PNP	3	10	OJ5114



Diffuse reflection sensor · M8 connector · 10...30 DC · plastics · IP67 · Connector groups 4, 5, 74, 80, 124

	Background suppression	7...150 mm	Red	0.8	H/D PNP	3	11	OJ5056
	Background suppression	15...200 mm	Red	2x1	H/D PNP	3	12	OJ5052
	Background suppression	15...200 mm	Red	2x1	H/D PNP	3	13	OJ5152

Rectangular housing O5 laser class 1

Type	Operating principle	Range	Type of light	Spot Ø at max. range [mm]	Output H = light-on D = dark-on	Wiring diag. no.	Draw- ing no.	Order no.
------	---------------------	-------	---------------	---------------------------	---------------------------------------	------------------------	---------------------	--------------

Through-beam sensor · M12 connector · 10...36 DC · plastics · IP67 · Connector groups 8, 10, 18, 20, 120, 124, 126, 128, 157

	Transmitter	60 m	Red	150	–	1	14	O5S700
	Receiver	60 m	Red	–	H/D PNP	2	15	O5E700

Type	Operating principle	Range	Type of light	Spot Ø at max. range [mm]	Output H = light-on D = dark-on	Wiring diagr. no.	Draw- ing no.	Order no.
------	---------------------	-------	---------------	---------------------------	---------------------------------------	-------------------------	---------------------	--------------

Retro-reflective sensor · M12 connector · 10...36 DC · plastics · IP67 · Connector groups 8, 10, 11, 18, 20, 120, 124, 126, 128, 130, 157, 158

	Polarisation filter	15 m	Red	40	H/D PNP	2	16	O5P700
---	---------------------	------	-----	----	---------	---	----	---------------

Diffuse reflection sensor · M12 connector · 10...36 DC · plastics · IP67 · Connector groups 8, 10, 11, 18, 20, 120, 124, 126, 128, 130, 157, 158

	Background suppression	20...200 mm	Red	1.2	H/D PNP	2	17	O5H700
---	------------------------	-------------	-----	-----	---------	---	----	---------------

Rectangular housing O1 Laser PerformanceLine with background suppression, laser class 2

Type	Operating principle	Range	Type of light	Spot Ø at max. range [mm]	Output H = light-on D = dark-on	Wiring diagr. no.	Draw- ing no.	Order no.
------	---------------------	-------	---------------	---------------------------	---------------------------------------	-------------------------	---------------------	--------------



Photoelectric distance sensor · M12 connector · 10...30 DC · metal · IP67 · Connector groups 8, 10, 11, 18, 20, 120, 124, 126, 128, 130, 157, 158

	Background suppression	0.2...10 m	–	< 15 x 15	normally open / closed programmable PNP	2	18	O1D101
--	------------------------	------------	---	-----------	--	---	----	---------------

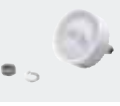
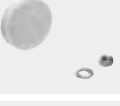

Photoelectric distance sensor · M12 connector · 10...30 DC · metal · IP67 · Connector groups 8, 10, 18, 20, 120, 124, 126, 128, 157

	Background suppression	0.2...10 m	–	< 15 x 15	normally open / closed programmable NPN	4	18	O1D104
---	------------------------	------------	---	-----------	--	---	----	---------------







Prismatic reflector

Type	Description	Order no.
	Prismatic reflector · Ø 10 mm · round · fixing by screw · M3 · for retro-reflective laser sensors · Housing materials: screw: stainless steel 316 / 1.4401 / spring washer: stainless steel 316 / 1.4401 / nut: stainless steel 316 / 1.4401 / front plate: PMMA / base: ABS	E20990
	Prismatic reflector · Ø 15 mm · round · fixing by screw · M3 · for retro-reflective laser sensors · Housing materials: screw: stainless steel 316 / 1.4401 / spring washer: stainless steel 316 / 1.4401 / nut: stainless steel 316 / 1.4401 / front plate: PMMA / base: ABS	E20992
	Prismatic reflector · Ø 19 mm · round · fixing by screw · M3 · for retro-reflective laser sensors · Housing materials: screw: stainless steel 316 / 1.4401 / spring washer: stainless steel 316 / 1.4401 / nut: stainless steel 316 / 1.4401 / front plate: PMMA / base: ABS	E20993
	Prismatic reflector · 11 x 11 mm · rectangular · fixing by screw · M3 · for retro-reflective laser sensors · Housing materials: screw: stainless steel 316 / 1.4401 / spring washer: stainless steel 316 / 1.4401 / nut: stainless steel 316 / 1.4401 / front plate: PMMA / base: ABS	E20991
	Prismatic reflector · 14 x 23 mm · rectangular · for retro-reflective laser sensors · Housing materials: front plate: PMMA / base: ABS	E20989

Position sensors















Type	Description	Order no.
	Prismatic reflector · 30 x 20 mm · rectangular · for retro-reflective laser sensors · Housing materials: front plate: PMMA / base: ABS	E20994
	Prismatic reflector · 50 x 10 mm · rectangular · for retro-reflective laser sensors · Housing materials: front plate: PMMA / base: ABS	E20988
	Prismatic reflector · 48 x 48 mm · rectangular · for retro-reflective laser sensors and glass and film detection · Housing materials: plastics	E20722

Accessories OG housing









Type	Description	Order no.
	Fixture for mounting and fine adjustment of laser units · Ø 18.5 mm · Clamp mounting · rod or free-standing depending on the clamp · for type OG · Housing materials: stainless steel 316Ti / 1.4571	E20737
	Fixture for mounting and fine adjustment of laser units · Ø 18.5 mm · Clamp mounting · rod mounting Ø 12 mm · for type OG · Housing materials: fixture: stainless steel 316Ti / 1.4571 / clamp: high-grade stainless steel	E21220
	Fixture for mounting and fine adjustment of laser units · Ø 18.5 mm · Clamp mounting · rod mounting Ø 12 mm · for type OG · Housing materials: fixture: stainless steel 316Ti / 1.4571 / clamp: diecast zinc	E21219
	Mounting set · Ø 18.5 mm · Clamp mounting · rod mounting Ø 12 mm · for type OG, IG, KG · Housing materials: clamp: diecast zinc / fixture: steel	E20720
	Mounting set · Ø 18.5 mm · Clamp mounting · rod mounting Ø 12 mm · for type OG, IG, KG · Housing materials: clamp: diecast zinc / fixture: steel	E20721
	Mounting set · Ø 18.5 mm · Clamp mounting · rod mounting Ø 12 mm · for type OG, IG, KG · Housing materials: clamp: high-grade stainless steel / fixture: high-grade stainless steel	E21206
	Mounting set · Ø 18.5 mm · Clamp mounting · rod mounting Ø 12 mm · for type OG, IG, KG · Housing materials: clamp: high-grade stainless steel / fixture: high-grade stainless steel	E21207

Accessories O5 housing

Type	Description	Order no.
	Angle bracket · for type O5 · Housing materials: stainless steel 316Ti / 1.4571	E21087
	Angle bracket · for type O5 · Housing materials: stainless steel 316Ti / 1.4571	E21085



Type	Description	Order no.
	Angle bracket · O5, O4 · for mounting O5, O4 sensors instead of OL sensors · Dovetail clamp · Housing materials: Dovetail clamp: AlMgSi0.5 / fixture: AlMg3	E21122
	Dovetail clamp · for type DTS, O4, O5 · Housing materials: AlMgSi0.5	E21088
	Mounting brackets Mounting on the back of the unit · for type O5 · Housing materials: stainless steel 316Ti / 1.4571	E21086
	Mounting sleeve · O5 · for mounting O5 sensors instead of OC sensors · Housing materials: AlZnMgCu1.5 F51/52	E21114
	Fixture for mounting and fine adjustment of laser units · Clamp mounting · rod or free-standing depending on the clamp · for type O5 · Housing materials: stainless steel 316Ti / 1.4571	E20794
	Mounting set · Clamp mounting · With protective cover · rod mounting Ø 12 mm · for type O5 · Housing materials: fixture: stainless steel 316Ti / 1.4571 / clamp: high-grade stainless steel	E21223
	Mounting set · Clamp mounting · With protective cover · rod mounting Ø 12 mm · for type O5 · Housing materials: stainless steel 316Ti / 1.4571 / clamp: diecast zinc	E21210
	Mounting set · Clamp mounting · rod mounting Ø 12 mm · for type O5, O5D · Housing materials: stainless steel 316Ti / 1.4571 / clamp: diecast zinc	E21211
	Mounting set · Clamp mounting · rod mounting Ø 12 mm · for type O5, O5D · Housing materials: stainless steel 316Ti / 1.4571 / clamp: high-grade stainless steel	E21212
	Mounting set · Clamp mounting · With protective cover · rod mounting Ø 14 mm · for type O5 · Housing materials: fixture: stainless steel 316Ti / 1.4571 / clamp: stainless steel	E21142
	Mounting set · Clamp mounting · With protective cover · Free-standing M10 · for type O5 · Housing materials: stainless steel 316Ti / 1.4571 / clamp: diecast zinc	E21084
	Mounting set · Clamp mounting · Free-standing M10 · for type O5 · Housing materials: stainless steel 316Ti / 1.4571 / clamp: diecast zinc	E21083
	Memory plug · Parameter memory for IO-Link sensors · Storage capacity: 2 Kbytes · Housing materials: PA PACM 12 / PET / sealing: FPM / nut: stainless steel 316L / 1.4404 / connector: TPU	E30398
	IO-Link interface · for parameter setting and analysis of units with max. 65 mA current consumption · Supported communication protocols: IO-Link (4800 and 38400 bits/s) EPS protocol (19200 bits/s) · for operation with FDT framework software "ifm Container" or software "LINERECORDER SENSOR"	E30396
	LINERECORDER SENSOR · Version 4.0.0 · Software for clear online and offline parameter setting of IO-Link sensors via USB adapter · Use via USB connection cable (drivers are supplied): E30396 IO-Link interface or E30390 IO-Link master (note the respective data sheet) · IODD import and update from ifm's homepage · Reading of IODDs via storage media · Automatic sensor identification · Graphic representation of the process values and history incl. export function · Documentation and archiving · Transferable parameter sets · Full memory plug support for IO-Link 1.1	QA0001

Accessories O1 housing





Type	Description	Order no.
	Prismatic reflector · 226 x 262 mm · rectangular · Housing materials: plastics	E21159
	Mounting adapter · O1D · for optical distance sensors · Process connection · G1 male · for type O1D · Housing materials: flange: stainless steel 316L / 1.4404 / sealing: FKM / Protective cover: PMMA transparent / screws: high-grade stainless steel	E21224
	Fixture for mounting and fine adjustment of laser units · O1D · Clamp mounting · rod or free-standing depending on the clamp · Housing materials: fixture: aluminium transparent anodised / plastics: POM / screws: stainless steel	E1D100
	Mounting set · E2D101 + E20938 + E20951	E21079
	Angle bracket · O1D, O4 · for type O1D, O4 · Housing materials: stainless steel 316L / 1.4404	E21120
	Protective bracket · O1D · for type O1D · Housing materials: Angle bracket: stainless steel 316 / 1.4401 / screws: stainless steel / housing: polyamide	E21236
	Protective cover · O1D · Housing materials: bezel: ZnAl4Cu1 finish black / window: PMMA transparent and colourless / sealing: FPM 75+/-5 Shore A black / screws: stainless steel	E21133
	Protective cover · O1D · Housing materials: bezel: ZnAl4Cu1 finish black / window: glass transparent and colourless / sealing: FPM 75+/-5 Shore A black / screws: stainless steel	E21171

Accessories for system components



Type	Description	Order no.
	mounting rod · Ø 10 / M8 · Length: 150 mm · straight · Housing materials: stainless steel 316Ti / 1.4571	E21081
	mounting rod · Ø 10 / M8 · Length: 200 mm · angled · Housing materials: stainless steel 316Ti / 1.4571	E80310
	mounting rod · Ø 12 / M10 · Length: 130 mm · straight · Housing materials: stainless steel 316Ti / 1.4571	E20938
	mounting rod · Ø 12 / M10 · Length: 200 mm · angled · Housing materials: stainless steel 316Ti / 1.4571	E20940
	Head cap screw · M8 x 40 mm · ISO 4762 (DIN 912) · free-standing M8 · Housing materials: screw: steel galvanised	E21204

Type	Description	Order no.
	Head cap screw · M10 x 45 mm · ISO 4762 (DIN 912) · Free-standing M10 · Housing materials: screw: steel galvanised	E21208
	Head cap screw · M10 x 45 mm · ISO 4762 (DIN 912) · Free-standing M10 · Housing materials: screw: high-grade stainless steel	E21209
	Cube · M10 · aluminium profile · Housing materials: diecast zinc	E20951

Cylindrical OI housing (M30) for optical distance measurement, laser class 2

Type	Operating principle	Range	Type of light	Spot Ø at max. range [mm]	Output H = light-on D = dark-on	Wiring diag. no.	Drawing no.	Order no.
Photoelectric distance sensor · M12 connector · 10...30 DC · metal · IP65 / IP67 · Display unit: cm, inch · Connector groups 8, 10, 18, 20, 120, 124, 126, 128, 157								
	Background suppression	0.03...2 m	Red	< 5	2 switching outputs normally open / closed complementary PNP	5	19	OID200
Photoelectric distance sensor · M12 connector · 10...30 DC · metal · IP65 / IP67 · Display unit: cm · Connector groups 8, 10, 18, 20, 120, 124, 126, 128, 157								
	Background suppression	0.03...2 m	Red	< 5	2 switching outputs normally open / closed complementary PNP	5	19	OID201
Photoelectric distance sensor · M12 connector · 10...30 DC · metal · IP65 / IP67 · Display unit: cm, inch · Connector groups 8, 10, 18, 20, 120, 124, 126, 128, 157								
	Background suppression	0.03...2 m	Red	< 5	2 switching outputs normally open / closed complementary NPN	6	19	OID202
Photoelectric distance sensor · M12 connector · 10...30 DC · metal · IP65 / IP67 / IP68 / IP69K · Display unit: cm · Connector groups 12, 13, 19, 21, 122, 126, 128, 130, 132, 159								
	Background suppression	0.03...2 m	Red	< 5	2 switching outputs normally open / closed complementary PNP	7	20	OID204





Cylindrical OI housing (M30) for optical distance measurement, laser class 1

Type	Operating principle	Range	Type of light	Spot Ø at max. range [mm]	Output H = light-on D = dark-on	Wiring diag. no.	Drawing no.	Order no.
Photoelectric distance sensor · M12 connector · 10...30 DC · metal · IP65 / IP67 · Display unit: cm, inch · Connector groups 8, 10, 18, 20, 120, 124, 126, 128, 157								
	Background suppression	0.03...2 m	Red	< 5	2 switching outputs normally open / closed complementary PNP	5	19	OID250
Photoelectric distance sensor · M12 connector · 10...30 DC · metal · IP65 / IP67 · Display unit: cm · Connector groups 8, 10, 18, 20, 120, 124, 126, 128, 157								
	Background suppression	0.03...2 m	Red	< 5	2 switching outputs normally open / closed complementary PNP	5	19	OID251

Position sensors

Type	Operating principle	Range	Type of light	Spot Ø at max. range [mm]	Output H = light-on D = dark-on	Wiring diagr. no.	Draw- ing no.	Order no.
Photoelectric distance sensor · M12 connector · 10...30 DC · metal · IP65 / IP67 / IP68 / IP69K · Display unit: cm · Connector groups 12, 13, 19, 21, 122, 126, 128, 130, 132, 159								
	Background suppression	0.03...2 m	Red	< 5	2 switching outputs normally open / closed complementary PNP	7	20	OID254

Rectangular housing O5 for optical distance measurement, laser class 2

Type	Operating principle	Range	Type of light	Spot Ø at max. range [mm]	Output H = light-on D = dark-on	Wiring diagr. no.	Draw- ing no.	Order no.
Photoelectric distance sensor · M12 connector · 10...30 DC · metal · IP65 / IP67 · Display unit: cm · Connector groups 8, 10, 18, 20, 120, 124, 126, 128, 157								
	Background suppression	0.03...2 m	Red	< 5	2 switching outputs normally open / closed complementary PNP	5	21	O5D100
Photoelectric distance sensor · M12 connector · 10...30 DC · metal · IP65 / IP67 · Display unit: inch · Connector groups 8, 10, 18, 20, 120, 124, 126, 128, 157								
	Background suppression	0.03...2 m	Red	< 5	2 switching outputs normally open / closed complementary PNP	5	21	O5D101
Photoelectric distance sensor · M12 connector · 10...30 DC · metal · IP65 / IP67 · Display unit: cm · Connector groups 8, 10, 18, 20, 120, 124, 126, 128, 157								
	Background suppression	0.03...2 m	Red	< 5	2 switching outputs normally open / closed complementary NPN	6	21	O5D102
	Background suppression	0.03...2 m	Red	< 5	2 switching outputs normally open / closed complementary PNP	5	21	O5D150
Photoelectric distance sensor · M12 connector · 10...30 DC · metal · IP65 / IP67 · Display unit: inch · Connector groups 8, 10, 18, 20, 120, 124, 126, 128, 157								
	Background suppression	0.03...2 m	Red	< 5	2 switching outputs normally open / closed complementary PNP	5	21	O5D151

Rectangular housing O1 for optical distance measurement, laser class 1

Type	Operating principle	Range	Sampling rate [Hz]	Spot Ø at max. range [mm]	U _b [V]	Wiring diagr. no.	Draw- ing no.	Order no.
Output function OUT1: normally open / closed programmable OUT2: normally open / closed programmable or analogue (4...20 mA / 0...10 V, scalable) · Wiring diagram no. 8 · Connector groups 8, 10, 18, 20, 120, 124, 126, 128, 157								
	Photoelectric distance sensor	0.3...6 m	1...33	< 8 x 8	18...30	8	18	O1D155

Rectangular housing O1 for optical distance measurement, laser class 2

Type	Operating principle	Range	Sampling rate [Hz]	Spot Ø at max. range [mm]	U _b [V]	Wiring diagr. no.	Drawing no.	Order no.
------	---------------------	-------	--------------------	---------------------------	--------------------	-------------------	-------------	-----------

Output function OUT1: normally open / closed programmable OUT2: normally open / closed programmable or analogue (4...20 mA / 0...10 V, scalable) · Wiring diagram no. 8 · Connector groups 8, 10, 18, 20, 120, 124, 126, 128, 157

	Photoelectric distance sensor	1...75 m on reflector E21159	1...33	< 150 x 150	18...30	8	18	O1D106
	Photoelectric distance sensor	0.2...10 m	1...33	< 15 x 15	18...30	8	18	O1D105
	Photoelectric distance sensor	0.2...10 m	1...50	< 15 x 15	18...30	8	18	O1D100

Output function OUT1: normally open / closed programmable OUT2: normally open / closed programmable or analogue (4...20 mA / 0...10 V, scalable) · Wiring diagram no. 9 · Connector groups 8, 10, 18, 20, 120, 124, 126, 128, 157

	Photoelectric distance sensor	0.2...10 m	1...50	< 15 x 15	18...30	9	18	O1D103
---	-------------------------------	------------	--------	-----------	---------	---	----	--------

Rectangular housing O1 Laser PerformanceLine with background suppression, laser class 2

Type	Operating principle	Range	Type of light	Spot Ø at max. range [mm]	Output H = light-on D = dark-on	Wiring diagr. no.	Drawing no.	Order no.
------	---------------------	-------	---------------	---------------------------	---------------------------------	-------------------	-------------	-----------

Photoelectric distance sensor · M12 connector · 10...30 DC · metal · IP67 · Connector groups 8, 10, 11, 18, 20, 120, 124, 126, 128, 130, 157, 158

	Background suppression	0.2...10 m	–	< 15 x 15	normally open / closed programmable PNP	2	18	O1D101
---	------------------------	------------	---	-----------	---	---	----	--------

Photoelectric distance sensor · M12 connector · 10...30 DC · metal · IP67 · Connector groups 8, 10, 18, 20, 120, 124, 126, 128, 157

	Background suppression	0.2...10 m	–	< 15 x 15	normally open / closed programmable NPN	4	18	O1D104
---	------------------------	------------	---	-----------	---	---	----	--------











Rectangular housing O1 for optical level measurement, laser class 2

Type	Operating principle	Range	Sampling rate [Hz]	Spot Ø at max. range [mm]	U _b [V]	Wiring diagr. no.	Drawing no.	Order no.
------	---------------------	-------	--------------------	---------------------------	--------------------	-------------------	-------------	-----------



Output function OUT1: normally open / closed programmable OUT2: normally open / closed programmable or analogue (4...20 mA / 0...10 V, scalable) · Wiring diagram no. 8 · Connector groups 8, 10, 18, 20, 120, 124, 126, 128, 157









	Optical level sensor	0.2...10 m	1...33	< 15 x 15	18...30	8	18	O1D300
---	----------------------	------------	--------	-----------	---------	---	----	--------

Accessories OI design (M30)



Type	Description	Order no.
	Mounting set · Clamp mounting · Free-standing M10 · for type O5 · Housing materials: stainless steel 316Ti / 1.4571 / clamp: diecast zinc	E21083
	Mounting set · Clamp mounting · With protective cover · Free-standing M10 · for type O5 · Housing materials: stainless steel 316Ti / 1.4571 / clamp: diecast zinc	E21084
	mounting rod · Ø 12 / M10 · Length: 130 mm · straight · Housing materials: stainless steel 316Ti / 1.4571	E20938
	Cube · M10 · aluminium profile · Housing materials: diecast zinc	E20951
	Angle bracket · for type O5 · Housing materials: stainless steel 316Ti / 1.4571	E21085
	Angle bracket · for type O5 · Housing materials: stainless steel 316Ti / 1.4571	E21087
	Dovetail clamp · for type DTS, O4, O5 · Housing materials: AlMgSi0.5	E21088
	Memory plug · Parameter memory for IO-Link sensors · Storage capacity: 2 Kbytes · Housing materials: PA PACM 12 / PET / sealing: FPM / nut: stainless steel 316L / 1.4404 / connector: TPU	E30398
	IO-Link interface · for parameter setting and analysis of units with max. 65 mA current consumption · Supported communication protocols: IO-Link (4800 and 38400 bits/s) EPS protocol (19200 bits/s) · for operation with FDT framework software "ifm Container" or software "LINERECORDER SENSOR"	E30396
	LINERECORDER SENSOR · Version 4.0.0 · Software for clear online and offline parameter setting of IO-Link sensors via USB adapter · Use via USB connection cable (drivers are supplied): E30396 IO-Link interface or E30390 IO-Link master (note the respective data sheet) · IODD import and update from ifm's homepage · Reading of IODDs via storage media · Automatic sensor identification · Graphic representation of the process values and history incl. export function · Documentation and archiving · Transferable parameter sets · Full memory plug support for IO-Link 1.1	QA0001



Accessories O5 housing

Type	Description	Order no.
	Angle bracket · for type M30 · Housing materials: stainless steel	E10737
	Mounting clamp · Ø 30 mm · with end stop · for type M30 · Housing materials: PC	E11049
	Mounting clamp · Ø 34 mm · Ø 30 mm · with reducing bush · for type M30 · Housing materials: PBT	E10077

Type	Description	Order no.
	Mounting set · Ø 30.2 mm · Clamp mounting · aluminium profile · for type II, KI, O1D, O1 · Housing materials: fixture: stainless steel 316Ti / 1.4571 / clamp: diecast zinc / Cube: diecast zinc	E20875
	Mounting set · Ø 30.2 mm · Clamp mounting · free-standing M12 · for type O1, II, KI · Housing materials: fixture: stainless steel 316Ti / 1.4571 / clamp: diecast zinc	E20873
	Mounting set · Ø 30.2 mm · Clamp mounting · free-standing M12 · for type O1, II, KI · Housing materials: fixture: stainless steel 316Ti / 1.4571 / clamp: stainless steel	E20874
	mounting rod · Ø 12 / M10 · Length: 130 mm · straight · Housing materials: stainless steel 316Ti / 1.4571	E20938
	Cube · M10 · aluminium profile · Housing materials: diecast zinc	E20951
	Memory plug · Parameter memory for IO-Link sensors · Storage capacity: 2 Kbytes · Housing materials: PA PACM 12 / PET / sealing: FPM / nut: stainless steel 316L / 1.4404 / connector: TPU	E30398
	IO-Link interface · for parameter setting and analysis of units with max. 65 mA current consumption · Supported communication protocols: IO-Link (4800 and 38400 bits/s) EPS protocol (19200 bits/s) · for operation with FDT framework software "ifm Container" or software "LINERECORDER SENSOR"	E30396
	LINERECORDER SENSOR · Version 4.0.0 · Software for clear online and offline parameter setting of IO-Link sensors via USB adapter · Use via USB connection cable (drivers are supplied): E30396 IO-Link interface or E30390 IO-Link master (note the respective data sheet) · IODD import and update from ifm's homepage · Reading of IODDs via storage media · Automatic sensor identification · Graphic representation of the process values and history incl. export function · Documentation and archiving · Transferable parameter sets · Full memory plug support for IO-Link 1.1	QA0001

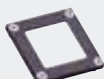
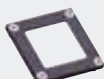
Accessories O1 housing

Type	Description	Order no.
	Prismatic reflector · 226 x 262 mm · rectangular · Housing materials: plastics	E21159
	Fixture for mounting and fine adjustment of laser units · O1D · Clamp mounting · rod or free-standing depending on the clamp · Housing materials: fixture: aluminium transparent anodised / plastics: POM / screws: stainless steel	E1D100
	Mounting set · E2D101 + E20938 + E20951	E21079
	Protective cover · O1D · Housing materials: bezel: ZnAl4Cu1 finish black / window: PMMA transparent and colourless / sealing: FPM 75+/-5 Shore A black / screws: stainless steel	E21133
	Protective cover · O1D · Housing materials: bezel: ZnAl4Cu1 finish black / window: glass transparent and colourless / sealing: FPM 75+/-5 Shore A black / screws: stainless steel	E21171

Type	Description	Order no.
	Cooling box · Protective housing with an active cooling system for the O1D design · for type O1D · Housing materials: housing: aluminium transparent anodised / cover: aluminium black anodised / bezel: aluminium black anodised / window: float glass / cable gland: Brass nickel-plated / nozzle: Brass nickel-plated / sealing: FPM	E21248
	Cable · 10 m	E12274

Wiring diagrams

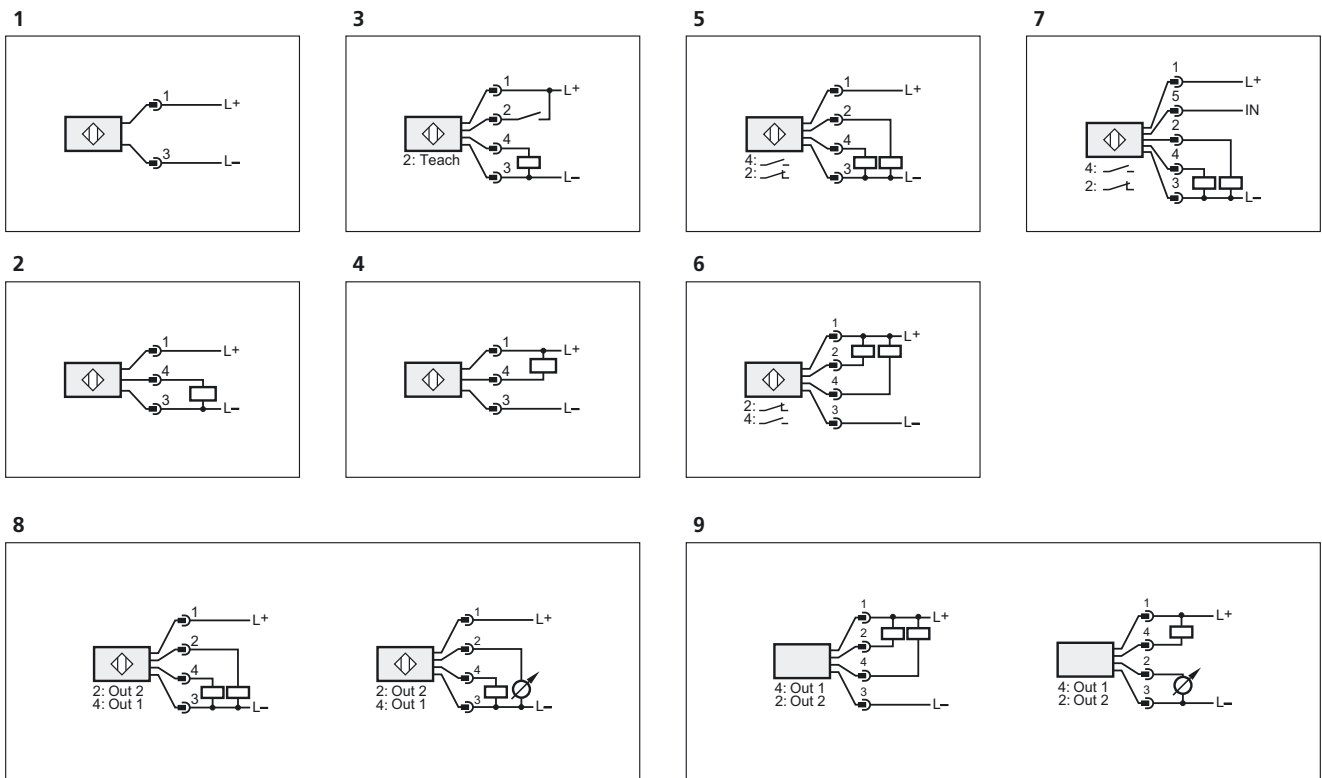

Scale drawings / drawing no. – CAD download: www.ifm.com

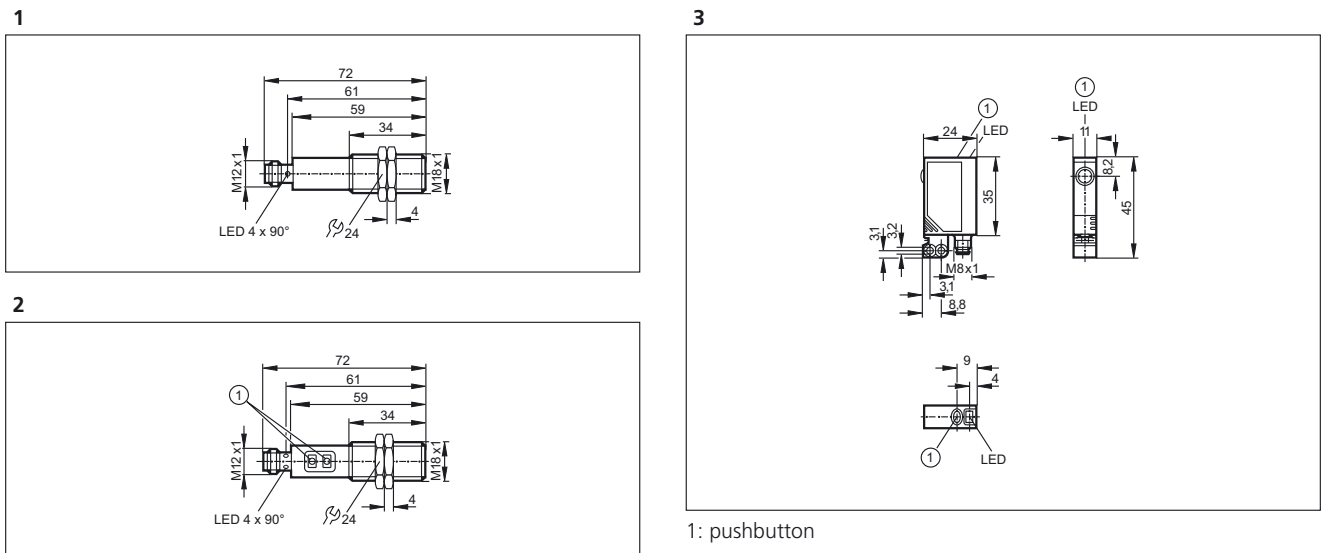

1: Programming buttons

Scale drawings / drawing no. – CAD download: www.ifm.com

4

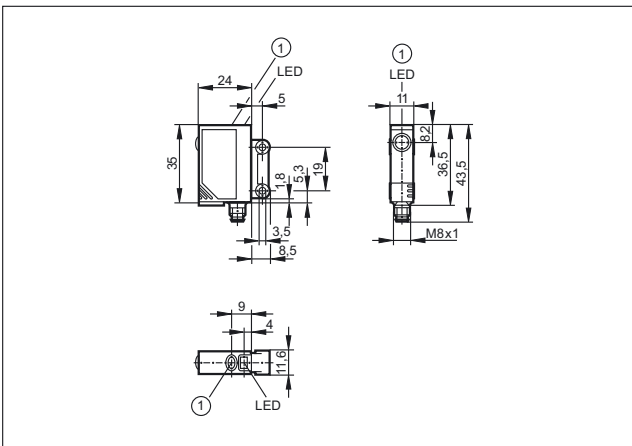

1: pushbutton

7

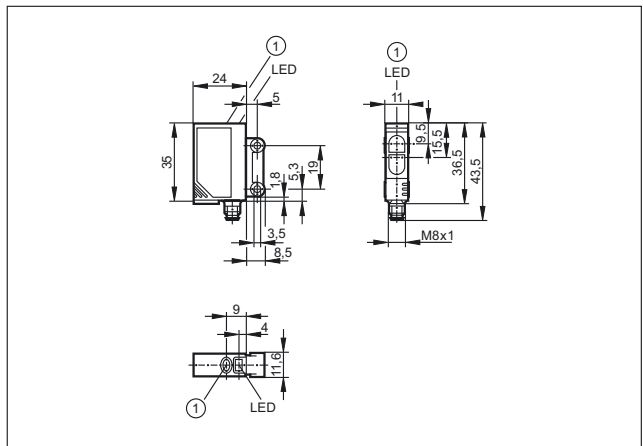

1: pushbutton

5

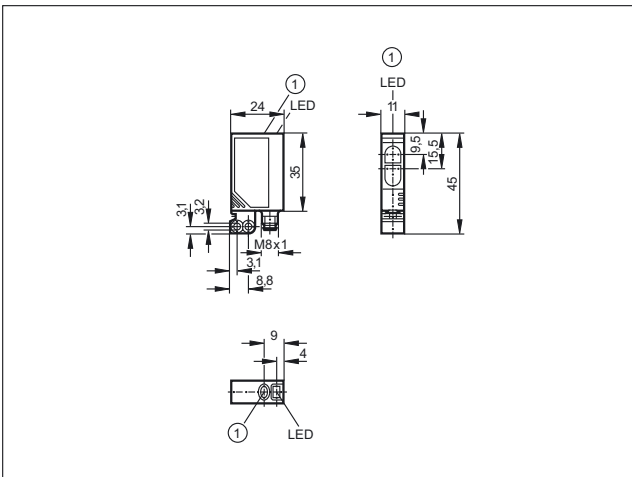

1: pushbutton

8

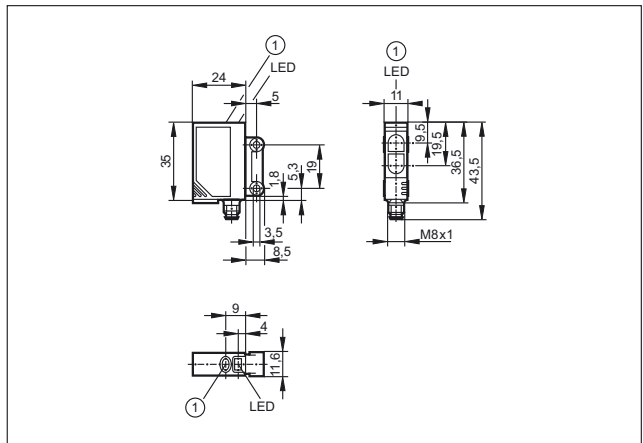

1: pushbutton

6

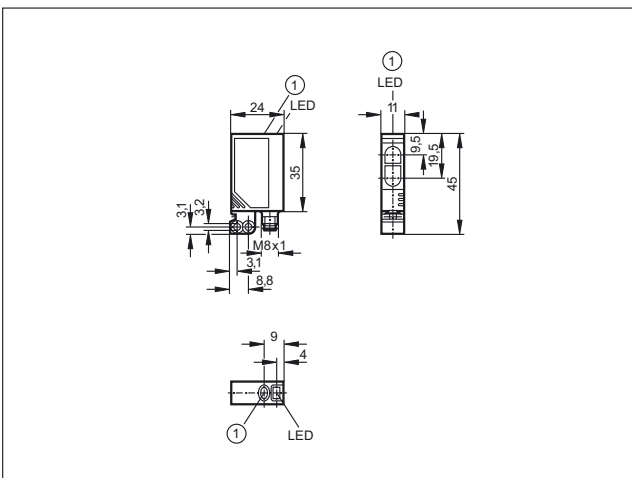

1: pushbutton

9

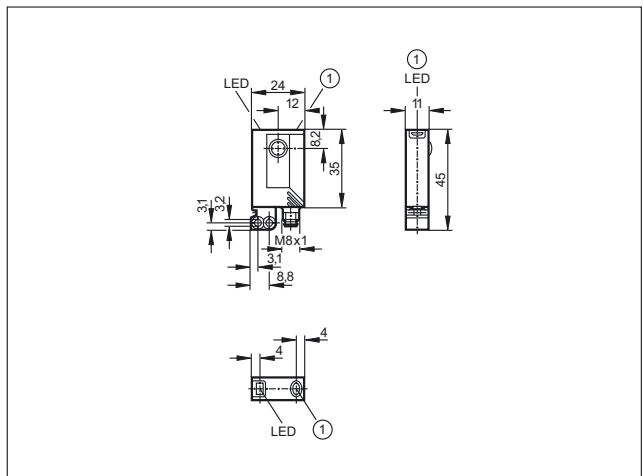

1: pushbutton

Scale drawings / drawing no. – CAD download: www.ifm.com

10

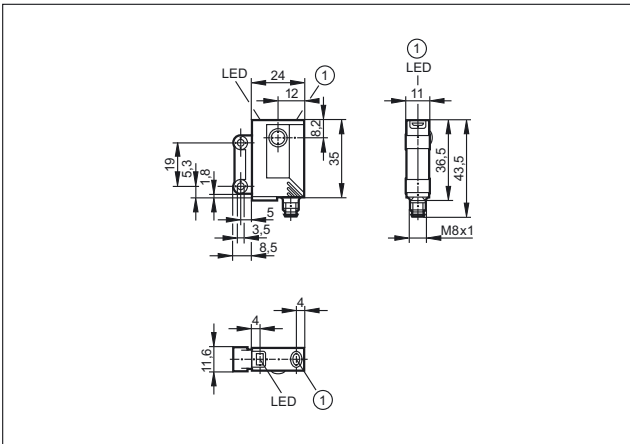

1: pushbutton

13

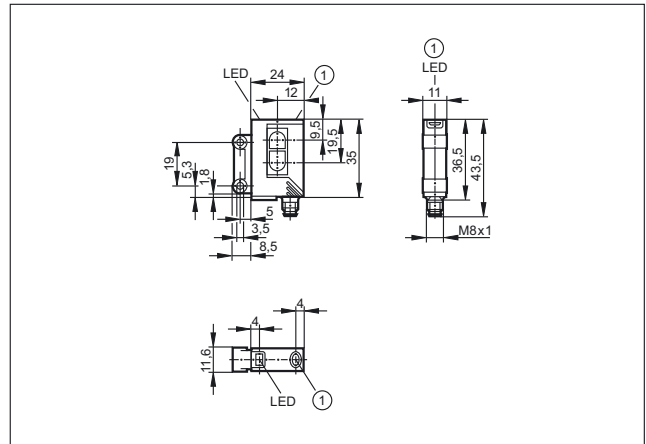

1: pushbutton

11

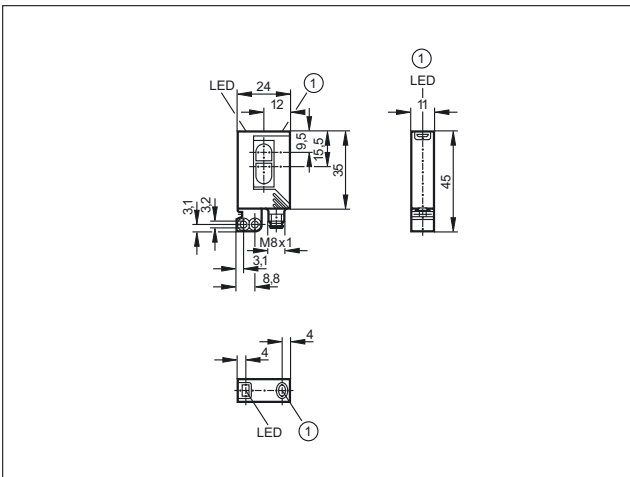

1: pushbutton

14

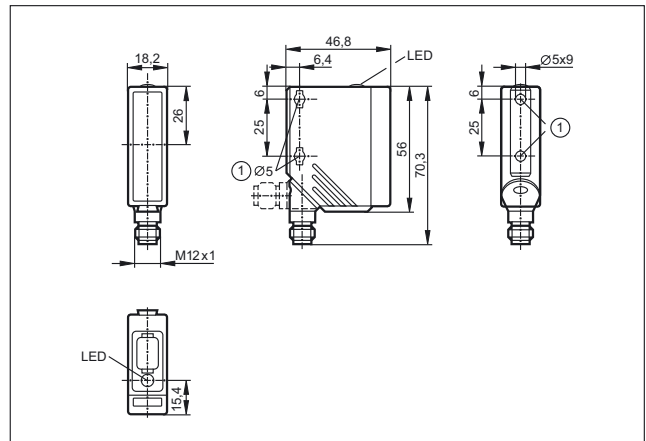

15

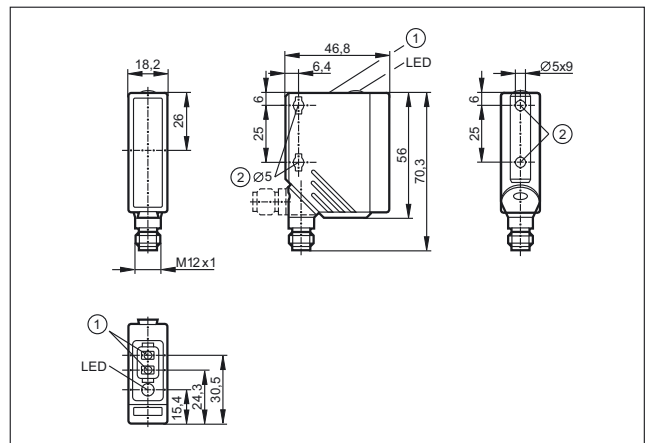

12

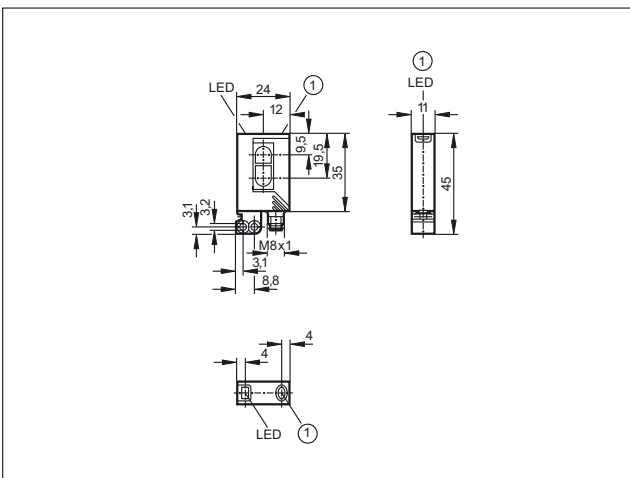

1: pushbutton

Scale drawings / drawing no. – CAD download: www.ifm.com

16

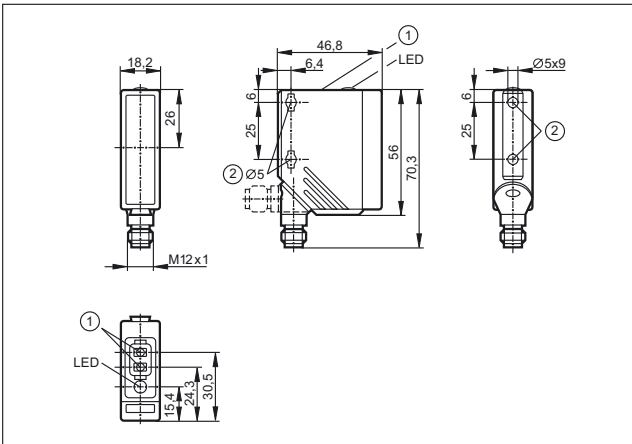

1: Programming buttons, 2: When a M5 mounting screw is used, the max. tightening torque is 2 Nm.

17

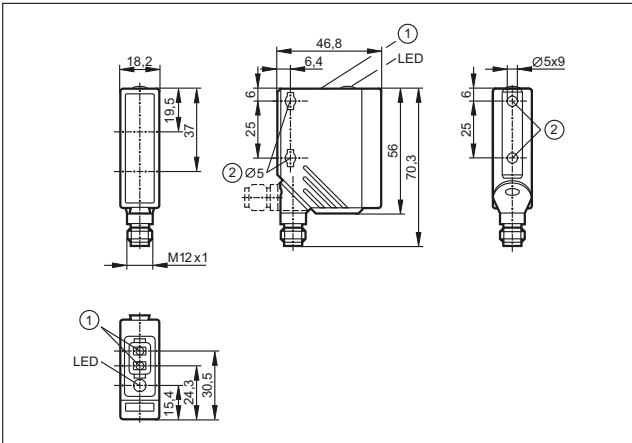

1: Programming buttons, 2: When a M5 mounting screw is used, the max. tightening torque is 2 Nm.

18

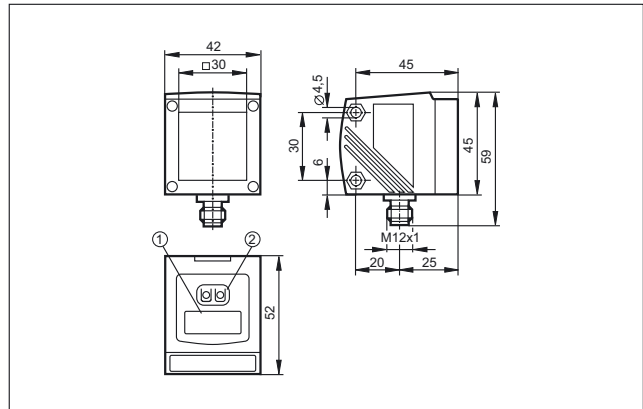

1: 4-digit alphanumeric display, 2: Programming buttons

19

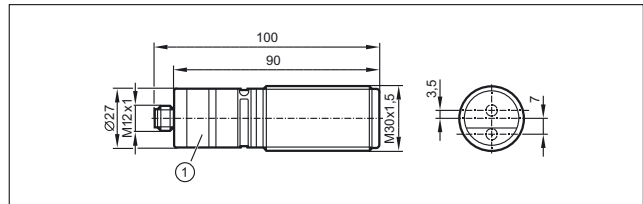

20

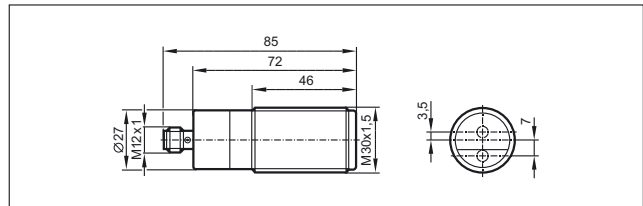

21

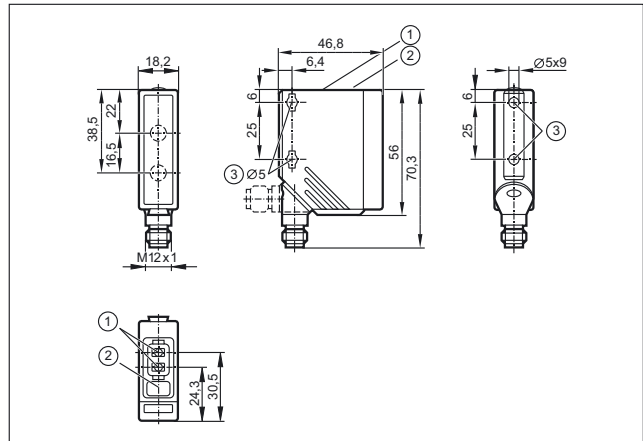



- Powerful single and multichannel fibre optic amplifiers
- Manual or automatic setting by means of “teach in”
- Helpful display to check operation, switching status and function
- Wide choice of fibre optics
- Easy mounting

Fibre optics systems

Fibre optics come into their own where mounting space is at a premium. They are connected to fibre optic amplifiers which contain the photoelectric components and output circuitry. Two photoelectric operating principles can be used:

Through-beam

Transmitting and receiving fibre optics are laid separately. The two ends (fibre optic heads) are mounted opposite each other. The light beam break is evaluated. As with standard photoelectrics this results in longer ranges and higher contrast for reliable sensing.

Diffuse reflection

Transmitting and receiving fibre optics are in one sheath and one sensing head. Evaluation is based on the diffuse reflection from the object, thus relies on the object surface characteristics.

Classification of fibre optics

Acrylic fibre optics

Acrylic fibre optics are suited for most standard applications. Acrylic fibres can be cut to length to fit the application.

High-flex fibre optics

More robust versions of the acrylic fibres are useful when the application places mechanic stresses on the fibre, such as repeated bending or a tight bend radius.

Glass fibre optics

Where particular demands such as heat or chemical resistance are placed on the fibre, glass fibre solutions are offered with sheathing materials which will also withstand harsh environments.

Versatile fibre optic amplifiers

The OOF amplifiers include some useful features. Logical combinations can be applied too, and two outputs can be assigned to one fibre, resulting in two switch-points from one sensing head. The pulse stretching function (delay time) allows the user to set a minimum pulse duration on the switching output. Where multiple fibres are used there is no danger of cross-talk, as the amplifier polls each one sequentially. The microprocessor-based setting is automated, while manual setting is also possible for critical situations.



Minute objects up to 0.5 mm are detected safely.

Fibre optic systems can also be mounted in places where access is difficult.



System overview	Page
OOF amplifiers for acrylic fibre optics	286
OBF amplifiers for acrylic fibre optics	286
Acrylic fibre optics for OBF / OOF housings, through-beam system	287
Acrylic fibre optics for OBF / OOF housings, through-beam system, highly flexible	287 - 288
Acrylic fibre optics for OBF / OOF housings, diffuse reflection system	288 - 289
Acrylic fibre optics for OBF / OOF housings, diffuse reflection system, highly flexible	289
Acrylic fibre optics for OBF / OOF housings, through-beam system, can be cut to length	289
Acrylic fibre optics for OBF / OOF housings, diffuse reflection system, can be cut to length	289
Acrylic fibres on a reel for OBF housing	290
OOF amplifiers for glass fibre optics	290
OKF amplifiers for glass fibre optics	290
OUF amplifiers for glass fibre optics	291
Glass fibre optics for OOF / OKF and OUF housings, through-beam system	291 - 292
Glass fibre optics for OOF / OKF and OUF housings, diffuse reflection system	292 - 293
Accessories	293 - 294
Wiring diagrams	294 - 295
Scale drawings / drawing no. – CAD download: www.ifm.com	296 - 302

OOF amplifiers for acrylic fibre optics

Type	Number of input channels	For fibre optics	Type of light	Sensing range through beam	Sensing range diffuse	Output H = light-on D = dark-on	U _b [V]	Drawing no.	Order no.
------	--------------------------	------------------	---------------	----------------------------	-----------------------	---------------------------------------	-----------------------	-------------	-----------

Type OOF · M12 connector · plastics · DC · Wiring diagram no. 1 · Connector groups 14, 16, 17

	2	FE/FT-11	Red	3.8 m	0...300 mm	H/D PNP	12...36	1	OO5000
---	---	----------	-----	-------	------------	---------	---------	---	--------

Type OOF · M12 connector · plastics · DC · Wiring diagram no. 5 · Connector groups 16, 17

	4	FE/FT-11	Red	3.8 m	0...300 mm	H/D PNP	12...36	2	OO5001
---	---	----------	-----	-------	------------	---------	---------	---	--------

Type OOF · M16 connector · plastics · DC · Wiring diagram no. 6 · Connector group 23

	6	FE/FT-11	Red	3.8 m	0...300 mm	H/D PNP	12...36	3	OO5002
---	---	----------	-----	-------	------------	---------	---------	---	--------

Type OOF · M16 connector · plastics · DC · Wiring diagram no. 7 · Connector group 23

	8	FE/FT-11	Red	3.8 m	0...300 mm	H/D PNP	12...36	4	OO5003
---	---	----------	-----	-------	------------	---------	---------	---	--------

OBF amplifiers for acrylic fibre optics

Type	Number of input channels	For fibre optics	Type of light	Sensing range through beam	Sensing range diffuse	Output H = light-on D = dark-on	U _b [V]	Drawing no.	Order no.
------	--------------------------	------------------	---------------	----------------------------	-----------------------	---------------------------------------	-----------------------	-------------	-----------

Type OBF · M12 connector · plastics · DC · Wiring diagram no. 8 · Connector groups 8, 10, 18, 20, 120, 124, 126, 128, 157

	1	FE/FT-11	Red	0...2 m	0...100 mm	H/D PNP/NPN	10...30	5	OBF500
---	---	----------	-----	---------	------------	-------------	---------	---	--------

Type OBF · M8 connector · plastics · DC · Wiring diagram no. 8 · Connector groups 4, 5, 74, 80, 124

	1	FE/FT-11	Red	0...2 m	0...100 mm	H/D PNP/NPN	10...30	6	OBF501
---	---	----------	-----	---------	------------	-------------	---------	---	--------













Type OBF · Cable 2 m · plastics · DC · Wiring diagram no. 9

	1	FE/FT-11	Red	0...2 m	0...100 mm	H/D PNP/NPN	10...30	7	OBF502
---	---	----------	-----	---------	------------	-------------	---------	---	--------

Type OBF · M8 connector · plastics · DC · Wiring diagram no. 10 · Connector groups 1, 3, 120

	1	FE/FT-11	Red	0...2 m	0...100 mm	H/D PNP/NPN	10...30	6	OBF503
---	---	----------	-----	---------	------------	-------------	---------	---	--------



Acrylic fibre optics for OBF / OOF housings, through-beam system

Type	System	Fibre optic material	Range OB50.. / OBF5.. / OO50.. [mm]	Sensing head material	Ambient temperature [°C]	Sheathing material	Drawing no.	Order no.
	FE-11	PMMA	60 / 130 / 160	aluminium	-40...70	PE (polyethylene)	8	E20609
	FE-11	PMMA	60 / 130 / 160	aluminium	-40...70	PE (polyethylene)	9	E20612
	FE-11	PMMA	150 / 210 / 800	aluminium	-40...70	PE (polyethylene)	9	E20615
	FE-11	PMMA	150 / 300 / 700	aluminium	-40...70	PE (polyethylene)	10	E20757
	FE-11	PMMA	200 / 350 / 800	aluminium	-40...70	PE (polyethylene)	11	E20603
	FE-11	PMMA	200 / 450 / 800	aluminium	-40...70	PE (polyethylene)	9	E20606
	FE-11	PMMA	400 / 900 / 1600	aluminium	-40...70	PE (polyethylene)	12	E20753
	FE-11	PMMA	1200 / 2000 / 3800	aluminium	-40...70	PE (polyethylene)	13	E20752
	FE-11	PMMA	60 / 130 / 160	stainless steel	-40...70	PE (polyethylene)	14	E20751
	FE-11	PMMA	140 / 230 / 400	stainless steel	-40...70	PE (polyethylene)	15	E20714
	FE-11	PMMA	200 / 450 / 800	stainless steel 316L / 1.4404	-40...70	PE (polyethylene)	16	E20750
	FE-11	PMMA	20 / 20 / 20	PA	-25...60	PE (polyethylene)	17	E20689



Acrylic fibre optics for OBF / OOF housings, through-beam system, highly flexible



Type	System	Fibre optic material	Range OB50.. / OBF5.. / OO50.. [mm]	Sensing head material	Ambient temperature [°C]	Sheathing material	Drawing no.	Order no.
	FE-11	PMMA	50 / 56 / 120	aluminium	-40...60	PE (polyethylene)	8	E21103

Position sensors



Type	System	Fibre optic material	Range OB50.. / OBF5.. / OO50.. [mm]	Sensing head material	Ambient temperature [°C]	Sheathing material	Draw- ing no.	Order no.
	FE-11	PMMA	50 / 56 / 120	aluminium	-40...60	PE (polyethylene)	9	E21104
	FE-11	PMMA	250 / 350 / 750	aluminium	-40...60	PE (polyethylene)	18	E21101
	FE-11	PMMA	250 / 350 / 750	aluminium	-40...60	PE (polyethylene)	9	E21102

Acrylic fibre optics for OBF / OOF housings, diffuse reflection system

Type	System	Fibre optic material	Range OB50.. / OBF5.. / OO50.. [mm]	Sensing head material	Ambient temperature [°C]	Sheathing material	Draw- ing no.	Order no.
	FT-11	PMMA	6 / 10 /	aluminium	-40...70	PE (polyethylene)	19	E20756
	FT-11	PMMA	20 / 25 / 60	aluminium	-40...70	PE (polyethylene)	20	E20639
	FT-11	PMMA	20 / 25 / 60	aluminium	-40...70	PE (polyethylene)	11	E20712
	FT-11	PMMA	60 / 70 / 300	aluminium	-40...70	PE (polyethylene)	21	E20645
	FT-11	PMMA	60 / 90 / 300	aluminium	-40...70	PE (polyethylene)	21	E20651
	FT-11	PMMA	60 / 70 / 300	aluminium	-40...70	PE (polyethylene)	22	E20648
	FT-11	PMMA	60 / 90 / 300	aluminium	-40...70	PE (polyethylene)	22	E20654
	FT-11	PMMA	60 / 75 / 200	aluminium	-40...70	PE (polyethylene)	23	E20758
	FT-11	PMMA	70 / 100 / 300	aluminium	-40...70	PE (polyethylene)	22	E20633
	FT-11	PMMA	15 / 25 / 60	stainless steel	-40...70	PE (polyethylene)	24	E20748
	FT-11	PMMA	20 / 25 / 60	stainless steel	-40...70	PE (polyethylene)	25	E20711

Type	System	Fibre optic material	Range OB50.. / OBF5.. / OO50.. [mm]	Sensing head material	Ambient temperature [°C]	Sheathing material	Draw- ing no.	Order no.
	FT-11	PMMA	40 / 60 / 150	stainless steel	-40...70	PE (polyethylene)	26	E20715
	FT-11	PMMA	70 / 100 / 300	stainless steel	-40...70	PE (polyethylene)	27	E20749
	FE-11	PMMA	–	–	-30...70	PE (polyethylene)	28	E20772

Acrylic fibre optics for OBF / OOF housings, diffuse reflection system, highly flexible

Type	System	Fibre optic material	Range OB50.. / OBF5.. / OO50.. [mm]	Sensing head material	Ambient temperature [°C]	Sheathing material	Draw- ing no.	Order no.
	FT-11	PMMA	10 / 10 / 30	aluminium	-40...60	PE (polyethylene)	29	E21106
	FT-11	PMMA	10 / 10 / 30	aluminium	-40...60	PE (polyethylene)	18	E21107
	FT-11	PMMA	70 / 104 / 180	aluminium	-40...60	PE (polyethylene)	30	E21105



Acrylic fibre optics for OBF / OOF housings, through-beam system, can be cut to length

Type	System	Fibre optic material	Range OB50.. / OBF5.. / OO50.. [mm]	Sensing head material	Ambient temperature [°C]	Sheathing material	Draw- ing no.	Order no.
	FE-11	PMMA	175 / 370 / 700	aluminium	-40...70	–	31	E20767





Acrylic fibre optics for OBF / OOF housings, diffuse reflection system, can be cut to length

Type	System	Fibre optic material	Range OB50.. / OBF5.. / OO50.. [mm]	Sensing head material	Ambient temperature [°C]	Sheathing material	Draw- ing no.	Order no.
	FT-11	PMMA	55 / 110 / 235	aluminium	-40...70	–	32	E20765



Acrylic fibres on a reel for OBF housing

Type	Description	Order no.
	acrylic fibres on a reel · 20 m · for type OBF, OOF · Housing materials: PE (polyethylene), Fibre optic: PMMA, can be cut to length	E20773
	acrylic fibres on a reel · 50 m · for type OBF, OOF · Housing materials: PE (polyethylene), Fibre optic: PMMA, can be cut to length	E20774

OOF amplifiers for glass fibre optics

Type	Number of input channels	For fibre optics	Type of light	Sensing range through beam	Sensing range diffuse	Output H = light-on D = dark-on	U _b [V]	Drawing no.	Order no.
Type OOF · M12 connector · plastics · DC · Wiring diagram no. 1 · Connector groups 14, 16, 17									
	2	FE/FT-00	Red	0.4 m	0...200 mm	H/D PNP	12...36	33	OO5004
Type OOF · M12 connector · plastics · DC · Wiring diagram no. 5 · Connector groups 16, 17									
	4	FE/FT-00	Red	0.4 m	0...200 mm	H/D PNP	12...36	34	OO5005
Type OOF · M16 connector · plastics · DC · Wiring diagram no. 6 · Connector group 23									
	6	FE/FT-00	Red	0.4 m	0...200 mm	H/D PNP	12...36	35	OO5006
Type OOF · M16 connector · plastics · DC · Wiring diagram no. 7 · Connector group 23									
	8	FE/FT-00	Red	0.4 m	0...200 mm	H/D PNP	12...36	36	OO5007

OKF amplifiers for glass fibre optics

Type	Number of input channels	For fibre optics	Type of light	Sensing range through beam	Sensing range diffuse	Output H = light-on D = dark-on	U _b [V]	Drawing no.	Order no.
Type OKF · Cable 2 m · plastics · DC · Wiring diagram no. 11									
	1	FE/FT-00	Red	0...0.12 m	0...40 mm	H/D PNP	10...36	37	OK5001
Type OKF · M12 connector · plastics · DC · Wiring diagram no. 12 · Connector groups 8, 10, 18, 20, 120, 124, 126, 128, 157									
	1	FE/FT-00	Red	0...0.12 m	0...40 mm	H/D PNP	10...36	38	OK5008

OUF amplifiers for glass fibre optics

Type	Number of input channels	For fibre optics	Type of light	Sensing range through beam	Sensing range diffuse	Output H = light-on D = dark-on	U _b [V]	Drawing no.	Order no.
------	--------------------------	------------------	---------------	----------------------------	-----------------------	---------------------------------------	-----------------------	-------------	-----------

Type OUF · Cable 2 m · plastics · DC · Wiring diagram no. 2

	1	FE/FT-00	Infrared	0.12 m	40 mm	H PNP	10...36	39	OU5001
	1	FE/FT-00	Infrared	0.12 m	40 mm	D PNP	10...36	39	OU5002









Type OUF · M12 connector · plastics · DC · Wiring diagram no. 3 · Connector groups 8, 10, 11, 18, 20, 120, 124, 126, 128, 130, 157, 158

	1	FE/FT-00	Infrared	0...0.12 m	0...40 mm	H PNP	10...36	40	OU5043
---	---	----------	----------	------------	-----------	-------	---------	----	--------

Type OUF · M12 connector · plastics · DC · Wiring diagram no. 4 · Connector groups 8, 9, 10, 11, 18, 20, 120, 124, 126, 128, 130, 131, 157, 158

	1	FE/FT-00	Infrared	0...0.12 m	0...40 mm	D PNP	10...36	40	OU5044
--	---	----------	----------	------------	-----------	-------	---------	----	--------

Glass fibre optics for OOF / OKF and OUF housings, through-beam system









Type	System	Fibre optic material	Range OOF / OKF / OUF [mm]	Sensing head material	Ambient temperature [°C]	Sheathing material	Drawing no.	Order no.
	FE-00	glass	400 / 120 / 120	aluminium	-20...80	PVC	41	E20059
	FE-00	glass	400 / 120 / 120	aluminium	-20...80	PVC	42	E20060
	FE-00	glass	400 / 120 / 120	aluminium	-20...80	PVC	43	E20062
	FE-00	glass	400 / 120 / 120	aluminium	-20...80	PVC	44	E20228
	FE-00	glass	160 / 50 / 50	stainless steel	-20...80	PVC	45	E20061
	FE-00	glass	400 / 120 / 120	aluminium	-40...290	aluminium	46	E20128
	FE-00	glass	400 / 120 / 120	aluminium	-40...290	aluminium	47	E20130
	FE-00	glass	400 / 120 / 120	aluminium	-40...290	aluminium	48	E20129





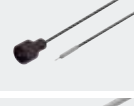

You can find wiring diagrams and scale drawings from page 294

Position sensors







Type	System	Fibre optic material	Range OOF / OKF / OUF [mm]	Sensing head material	Ambient temperature [°C]	Sheathing material	Drawing no.	Order no.
	FE-00	glass	160 / 50 / 50	stainless steel	-40...290	aluminium	49	E20127
	FE-00	glass	160 / 50 / 50	stainless steel	-20...150	metal silicone	50	E20506
	FE-00	glass	400 / 120 / 120	stainless steel	-20...150	metal silicone	51	E20505
	FE-00	glass	400 / 120 / 120	stainless steel	-20...150	metal silicone	52	E20492
	FE-00	glass	400 / 120 / 120	stainless steel	-20...150	metal silicone	53	E20493

Glass fibre optics for OOF / OKF and OUF housings, diffuse reflection system





Type	System	Fibre optic material	Range OOF / OKF / OUF [mm]	Sensing head material	Ambient temperature [°C]	Sheathing material	Drawing no.	Order no.
	FT-00	glass	200 / 40 / 40	aluminium	-20...80	PVC	54	E20051
	FT-00	glass	200 / 40 / 40	aluminium	-20...80	PVC	55	E20052
	FT-00	glass	200 / 40 / 40	aluminium	-20...80	PVC	56	E20054
	FT-00	glass	200 / 40 / 40	Brass	-20...80	PVC	57	E20249
	FT-00	glass	24 / 6 / 6	stainless steel	-20...80	PVC	58	E20230
	FT-00	glass	24 / 8 / 8	stainless steel	-20...80	PVC	45	E20053
	FT-00	glass	200 / 40 / 40	aluminium	-40...290	aluminium	59	E20055
	FT-00	glass	200 / 40 / 40	aluminium	-40...290	aluminium	60	E20056
	FT-00	glass	200 / 40 / 40	aluminium	-40...290	aluminium	61	E20058

Type	System	Fibre optic material	Range OOF / OKF / OUF [mm]	Sensing head material	Ambient temperature [°C]	Sheathing material	Drawing no.	Order no.
	FT-00	glass	24 / 8 / 8	stainless steel	-40...290	aluminium	49	E20057
	FT-00	glass	24 / 8 / 8	stainless steel	-20...150	metal silicone	50	E20507
	FT-00	glass	200 / 40 / 40	stainless steel	-20...150	metal silicone	62	E20489
	FT-00	glass	200 / 40 / 40	stainless steel	-20...150	metal silicone	63	E20494
	FT-00	glass	200 / 40 / 40	stainless steel	-20...150	metal silicone	56	E20495
	FT-00	glass	- / 40 / 40	Brass	-20...80	–	64	E20078
	FT-00	glass	200 / 40 / 40	stainless steel	-25...80	–	65	E20215

Accessories

Type	Description	Order no.
	Lens attachment · Ø 5 mm / M3 · for through-beam fibre optics · Housing materials: aluminium black anodised / glass	E20679
	Lens attachment · Ø 6 mm / M4 · for through-beam fibre optics · Housing materials: aluminium black anodised / glass	E20680
	Lens attachment · D5x10-M3-ALU · for through-beam fibre optics · M3 · Housing materials: aluminium black anodised	E20754
	Lens attachment · D5x10-M4-ALU · for through-beam fibre optics · M4 · Housing materials: aluminium black anodised	E20755
	Diaphragm attachment · D5x10-M3-ALU/D0.4 · for through-beam fibre optics · M3 · Housing materials: aluminium black anodised	E20762
	Angle bracket · for type OBF · Housing materials: steel galvanised	E20593
	Angle bracket · OU · with mounting material · Housing materials: galvanised steel	E20211

You can find wiring diagrams and scale drawings from page 294

Type	Description	Order no.
	Mounting clamp · Ø 3 mm · for fibre optics · Housing materials: aluminium black anodised	E20107
	Mounting clamp · Ø 3.5 mm · for fibre optics · Housing materials: aluminium black anodised	E20106
	Mounting clamp · Ø 4.5 mm · for fibre optics · Housing materials: aluminium black anodised	E20105
	Mounting clamp · Ø 5 mm · for fibre optics · Housing materials: aluminium black anodised	E20104
	Mounting clamp · Ø 6 mm · for fibre optics · Housing materials: aluminium black anodised	E20103
	Mounting clamp · Ø 7 mm · for fibre optics · Housing materials: aluminium black anodised	E20102
	Mounting clamp · Ø 8 mm · Housing materials: aluminium black anodised	E10221
	Mounting clamp · Ø 10 mm · for fibre optics · Housing materials: PBT	E20353
	cutter for fibre optics · for type FE/FT-11 · Housing materials: plastics	E20600

Wiring diagrams

Core colours

- BK black
- BN brown
- BU blue
- VT lilac
- WH white

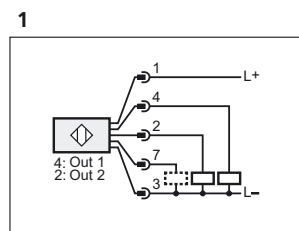

7: function check

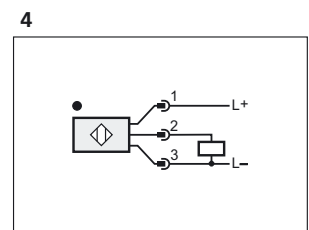
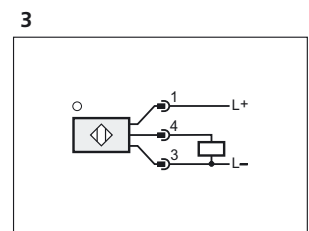
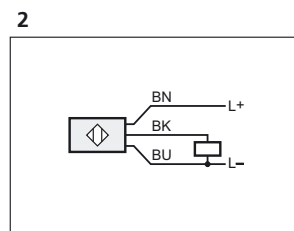

Wiring diagrams

5

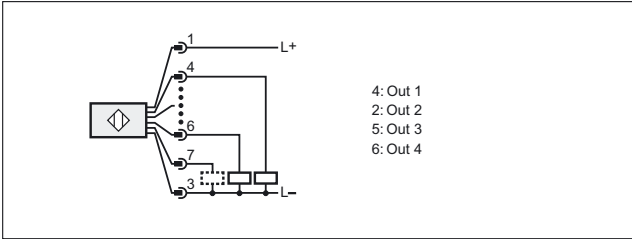

7: function check

6

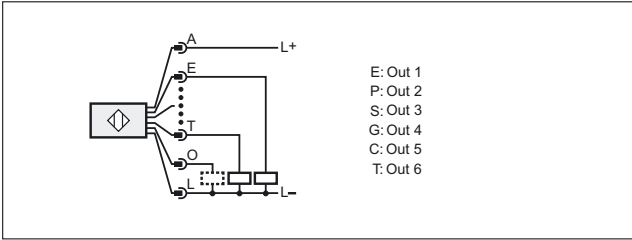

O: function check

7

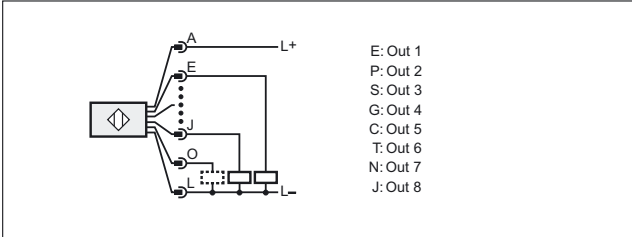

O: function check

8

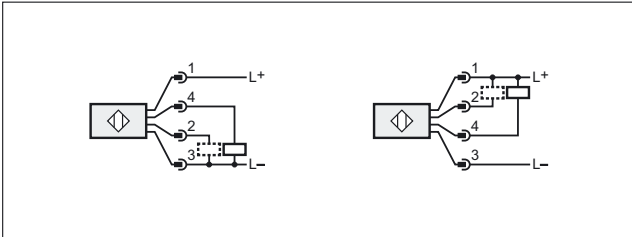

9

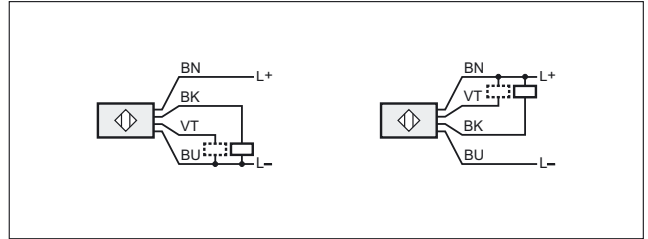

10

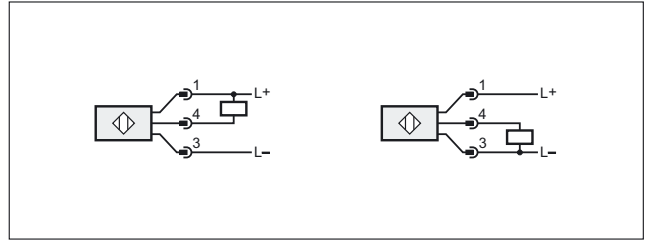

11

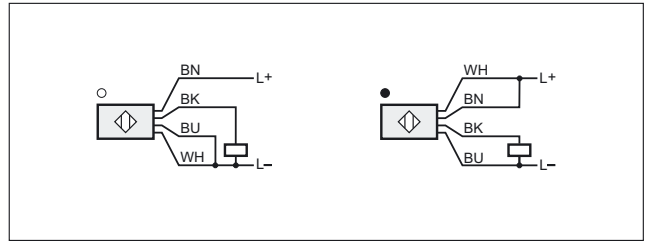

12

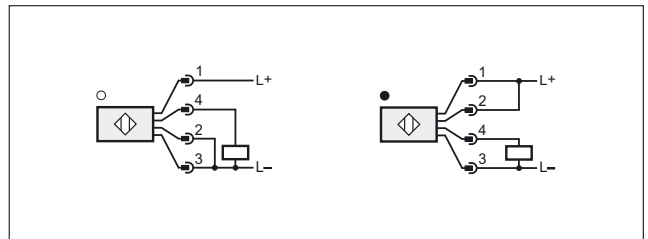

Scale drawings / drawing no. – CAD download: www.ifm.com

1

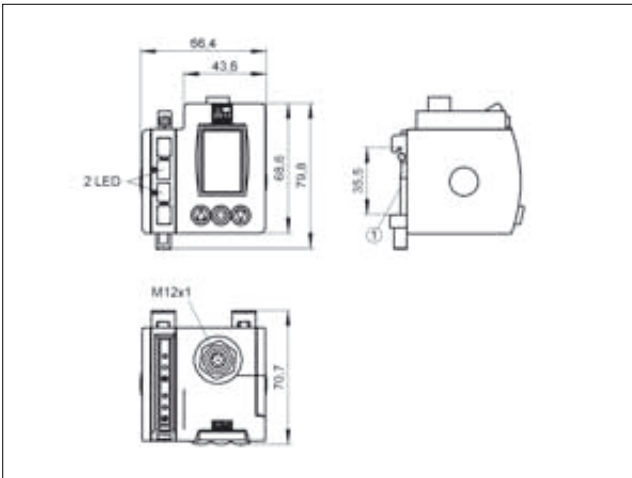

1: Mounting on DIN rail

4

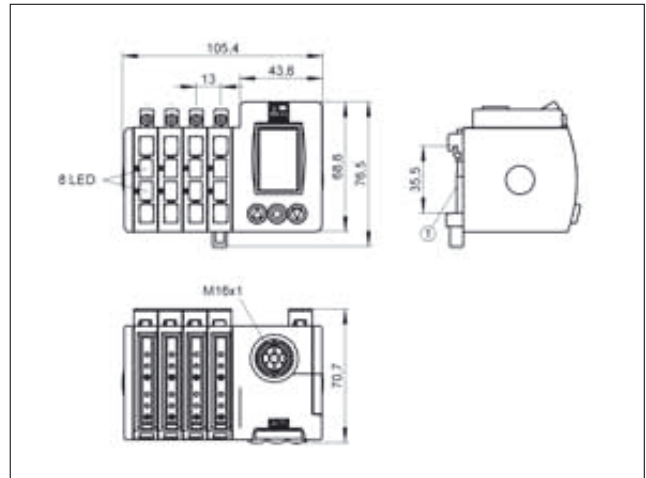

1: Mounting on DIN rail

2

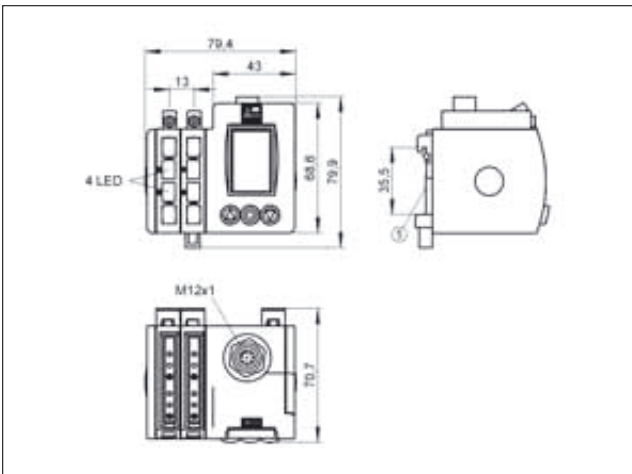

1: Mounting on DIN rail

5

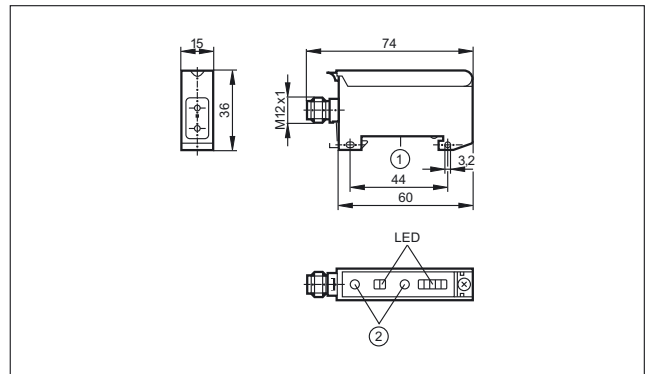

1: Mounting on DIN rail, 2: setting pushbuttons

3

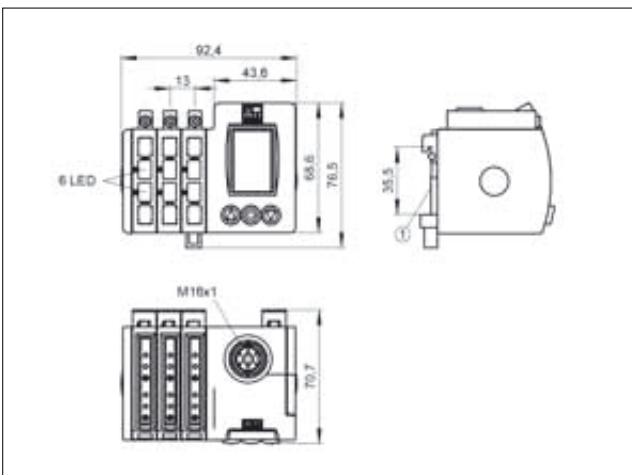

1: Mounting on DIN rail

6

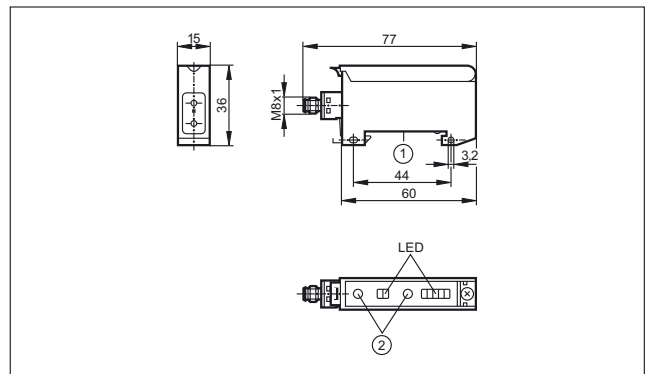

1: Mounting on DIN rail, 2: setting pushbuttons

Scale drawings / drawing no. – CAD download: www.ifm.com

7

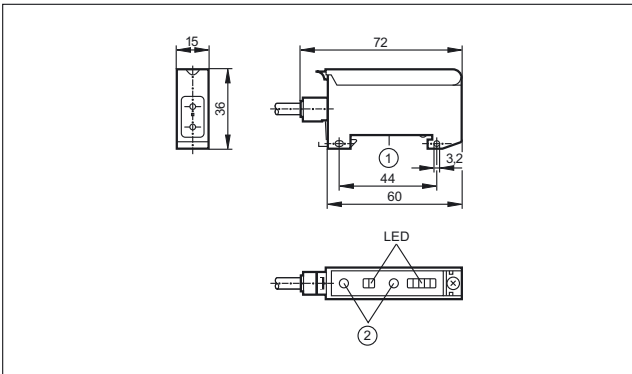

1: Mounting on DIN rail, 2: setting pushbuttons

8

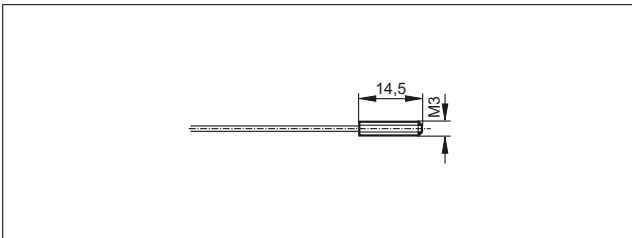

9

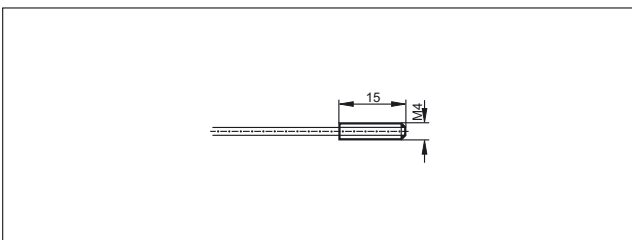

10

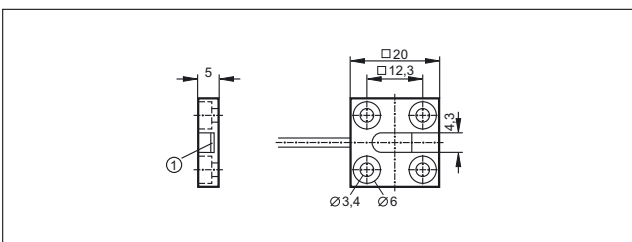

1: Sensing surface

11

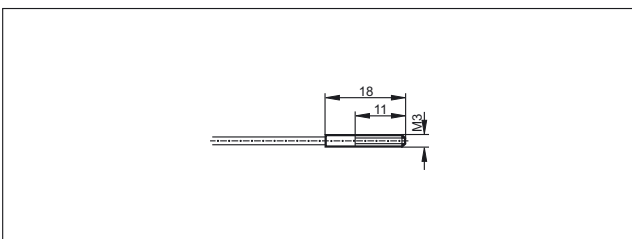

12

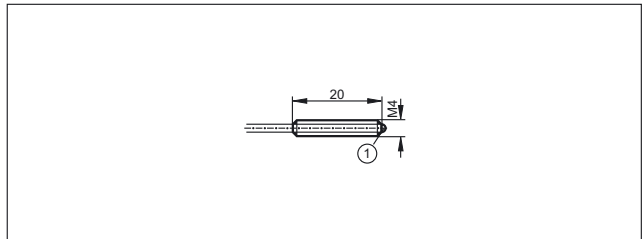

1: glass lens

13

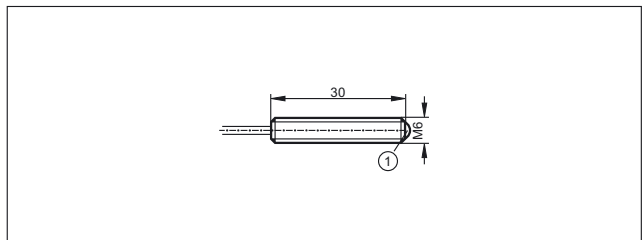

1: glass lens

14

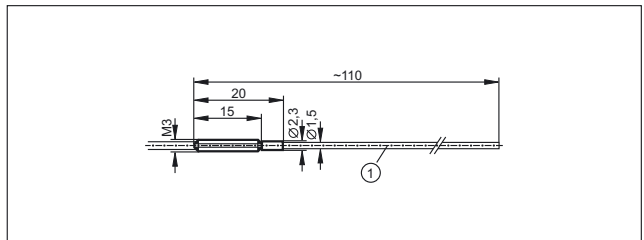

1: bendable

15

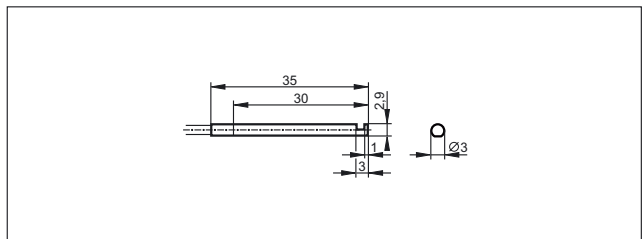

16

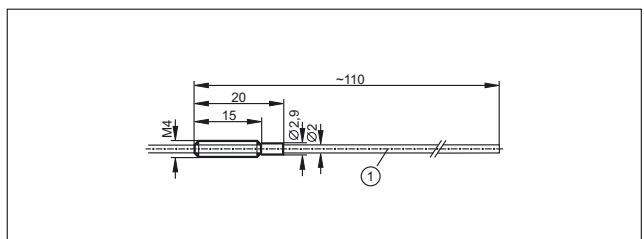

1: bendable

Scale drawings / drawing no. – CAD download: www.ifm.com

17

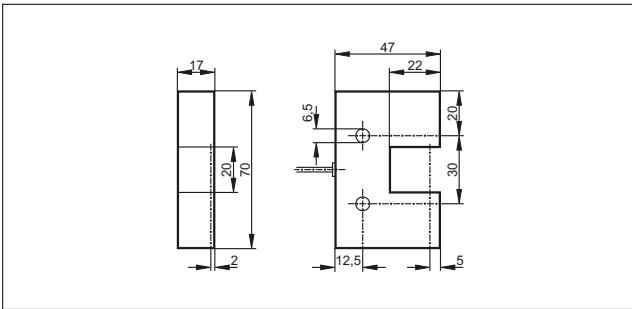

23

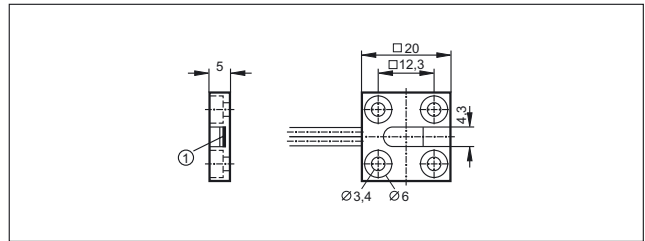

1: Sensing surface

18

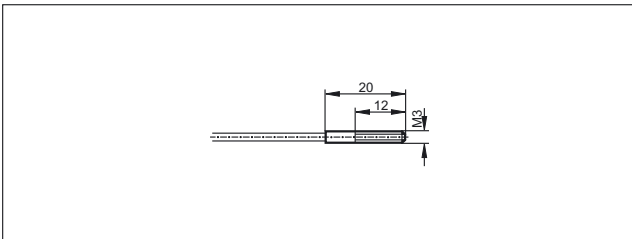

24

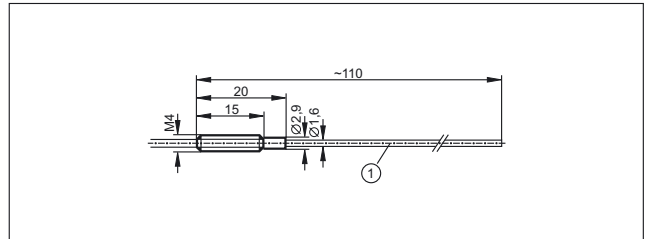

1: bendable

19

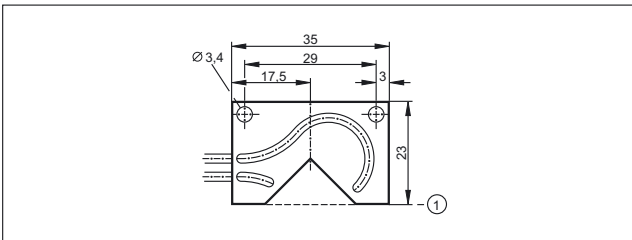

1: Reference edge

25

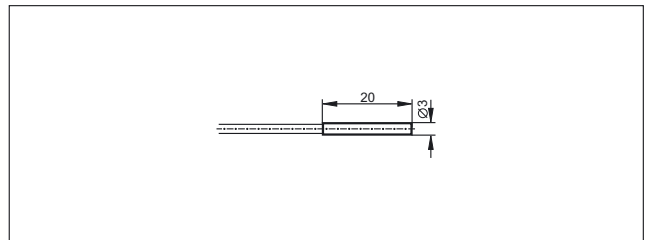

20

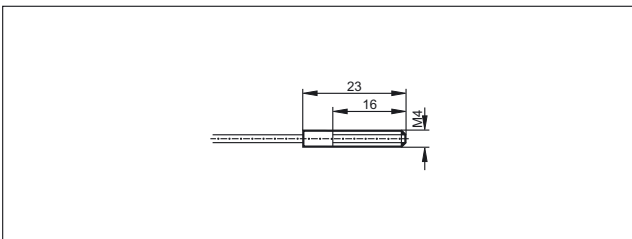

26

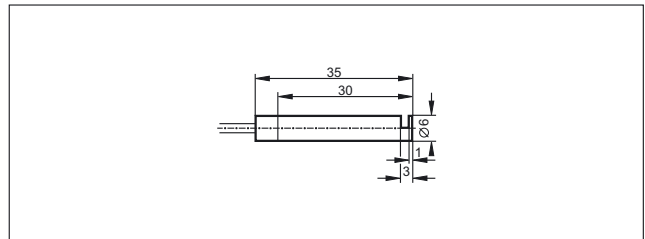

21

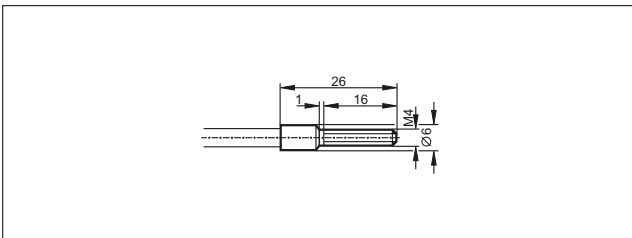

27

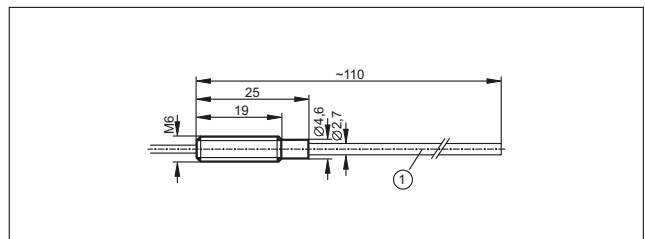

1: bendable

22

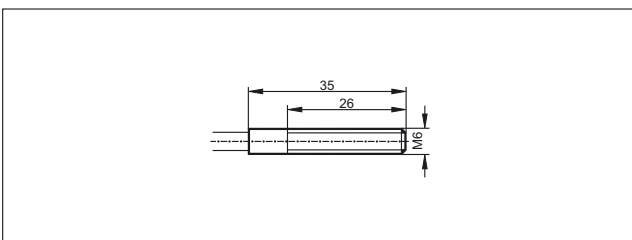

Scale drawings / drawing no. – CAD download: www.ifm.com

28

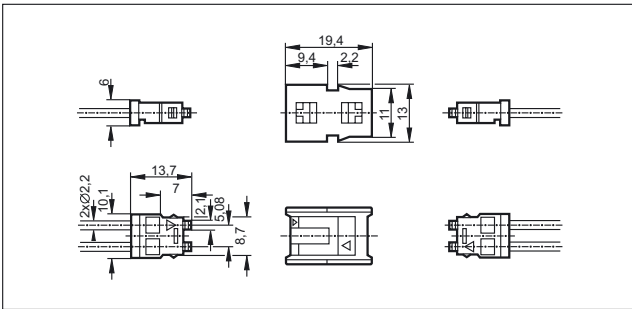

29

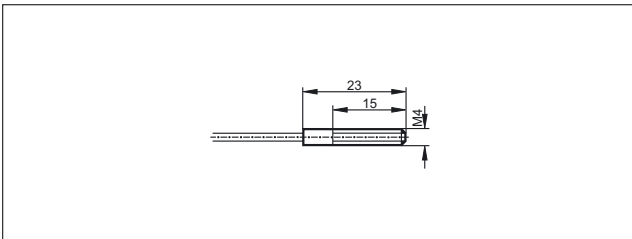

30

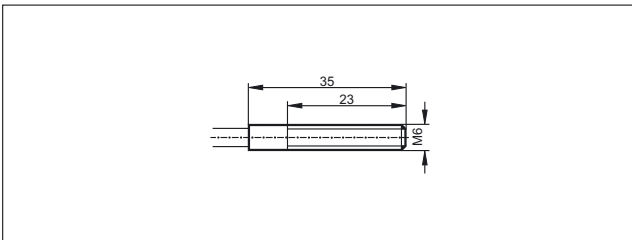

31

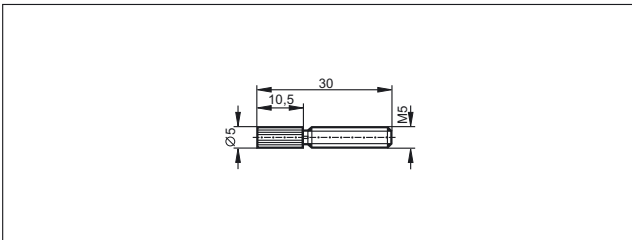

32

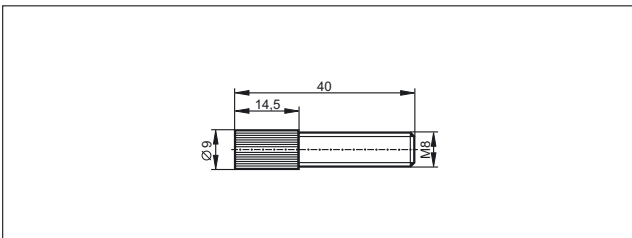

33

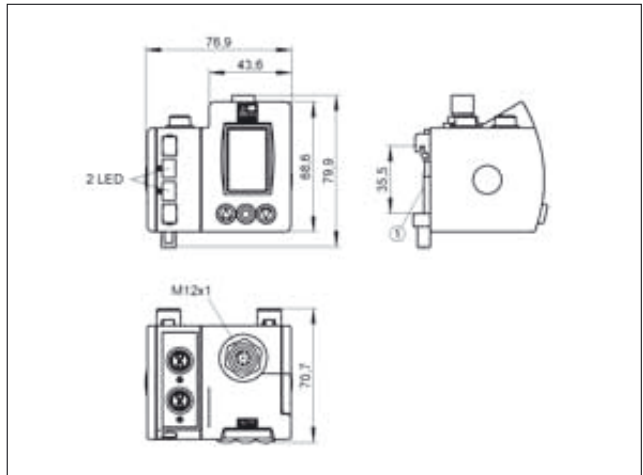

1: Mounting on DIN rail

34

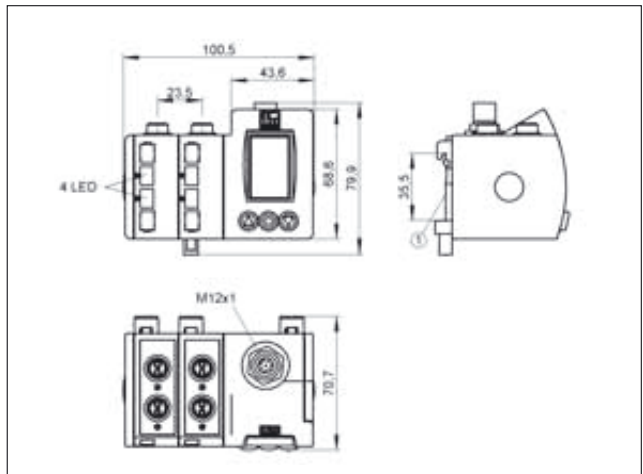

1: Mounting on DIN rail

35

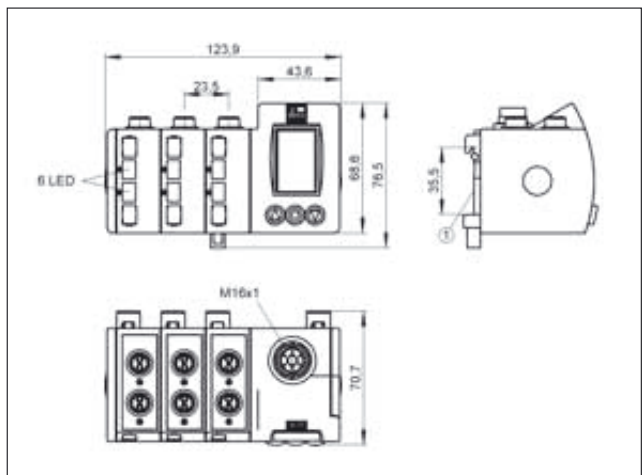

1: Mounting on DIN rail

Scale drawings / drawing no. – CAD download: www.ifm.com

36

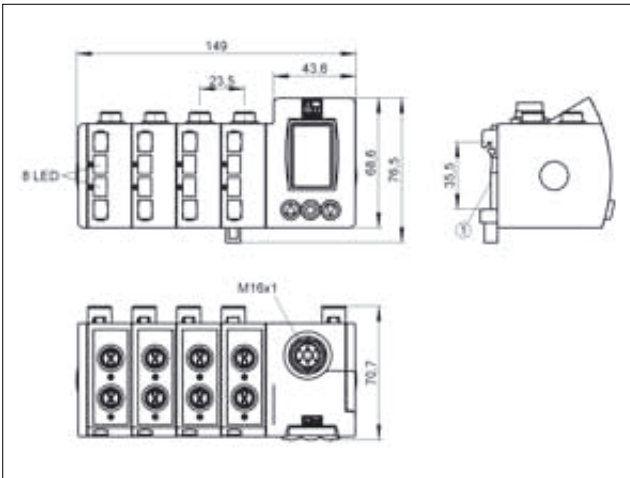

1: Mounting on DIN rail

37

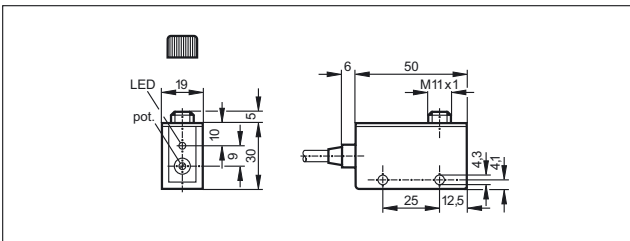

38

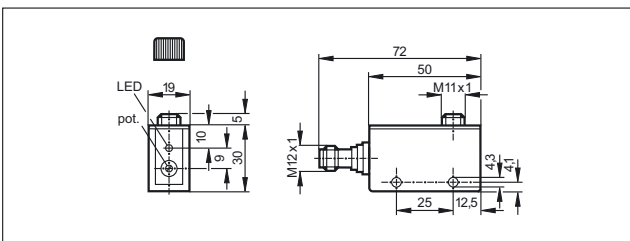

39

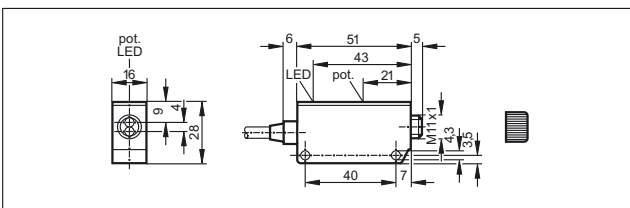

40

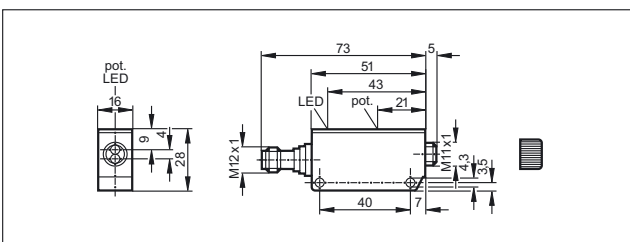

41

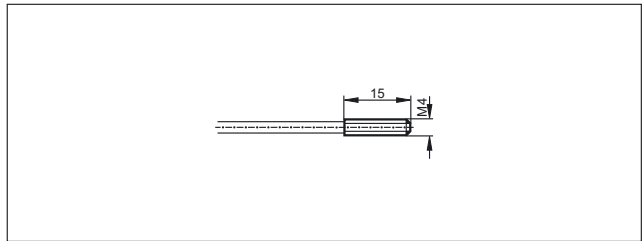

42

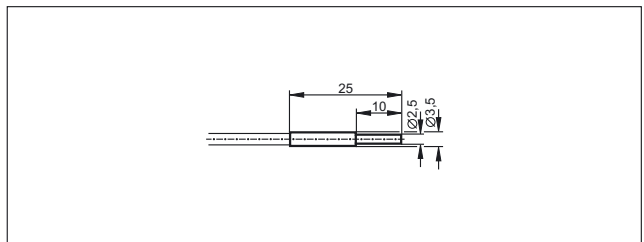

43

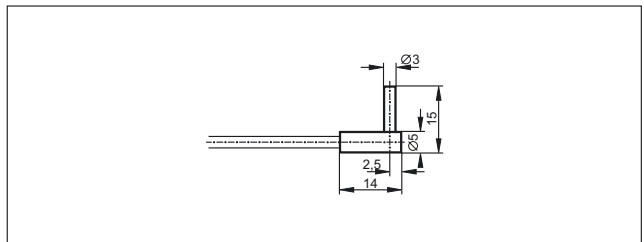

44

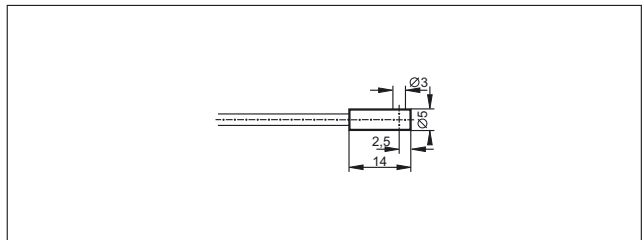

45

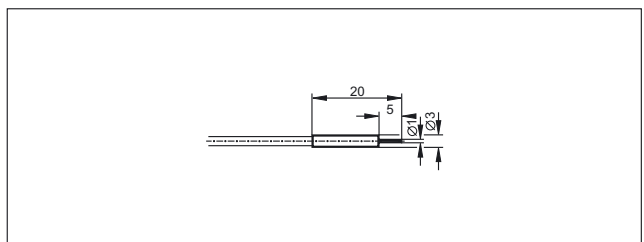

46

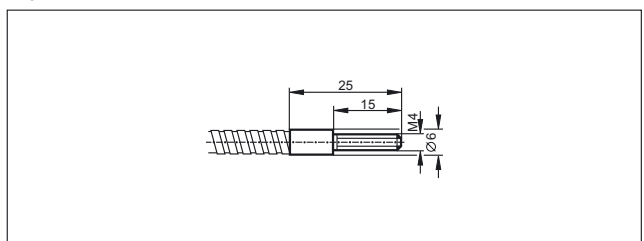

Scale drawings / drawing no. – CAD download: www.ifm.com

47

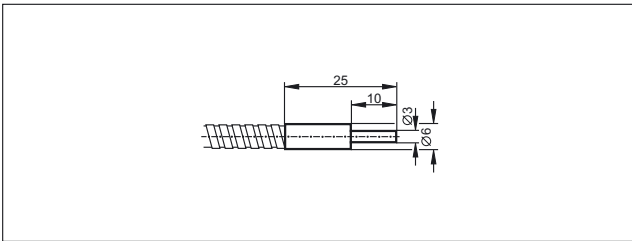

53

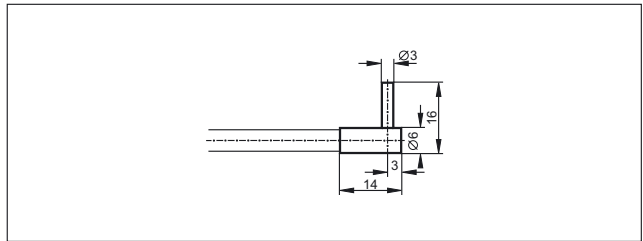

48

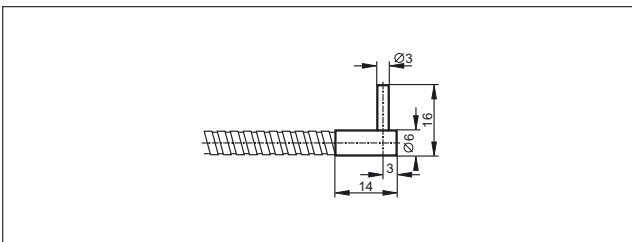

54

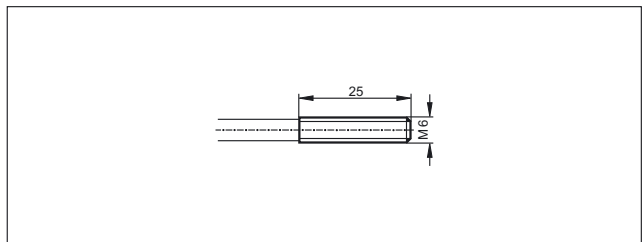

49

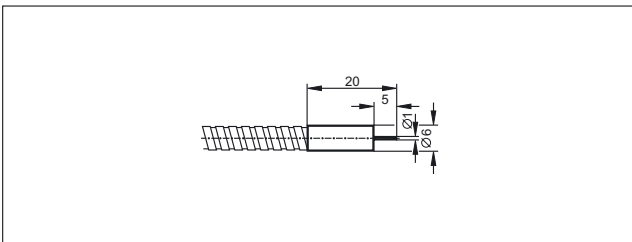

55

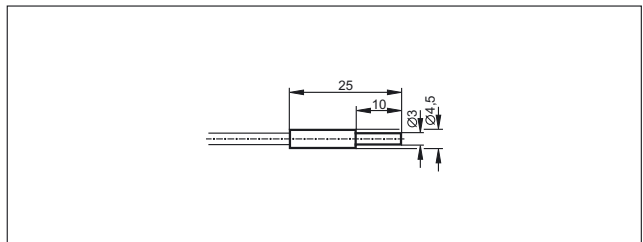

50

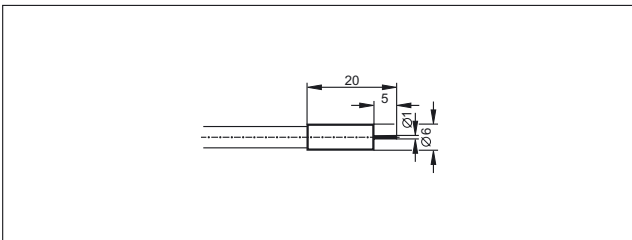

56

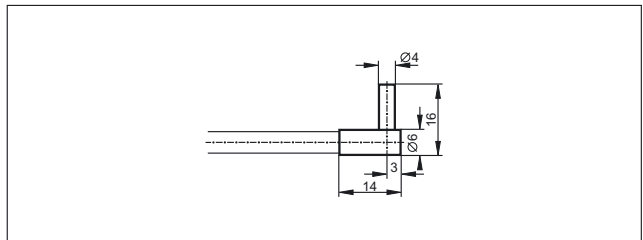

51

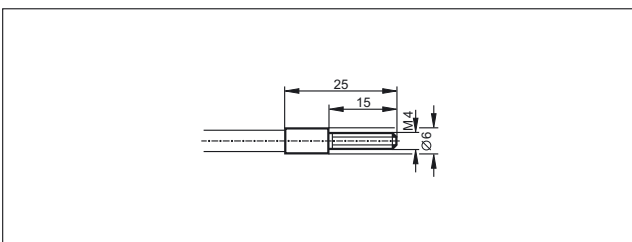

57

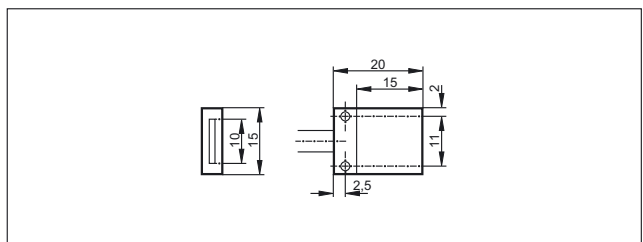

52

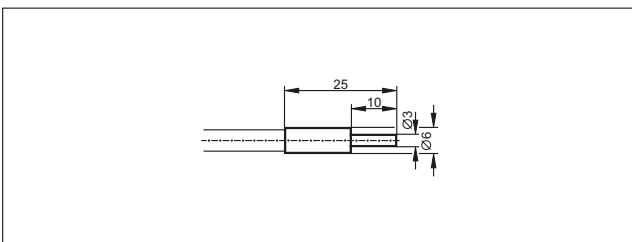

58

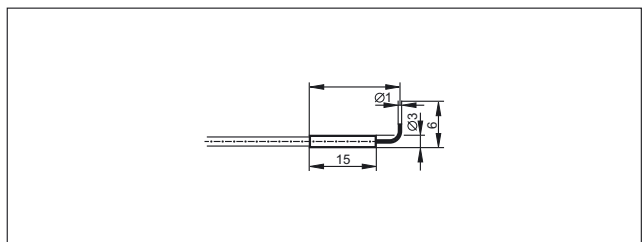

Scale drawings / drawing no. – CAD download: www.ifm.com

59

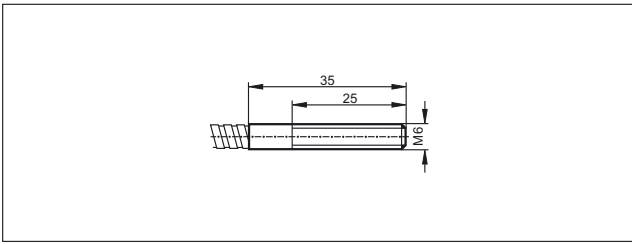

63

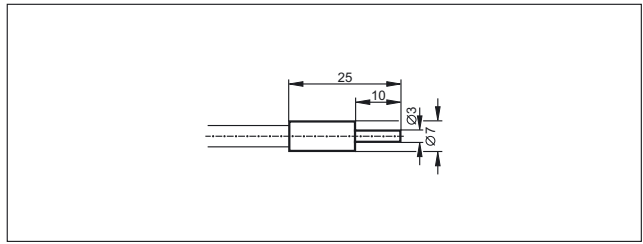

60

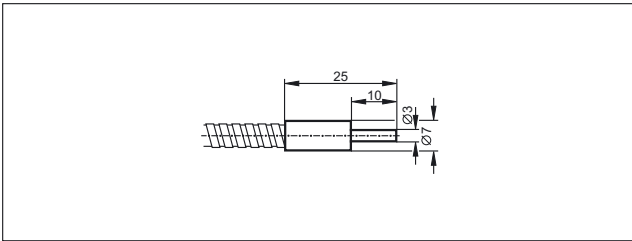

64

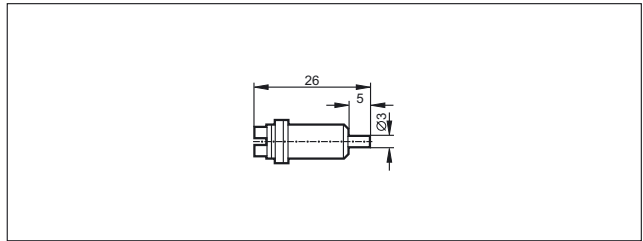

61

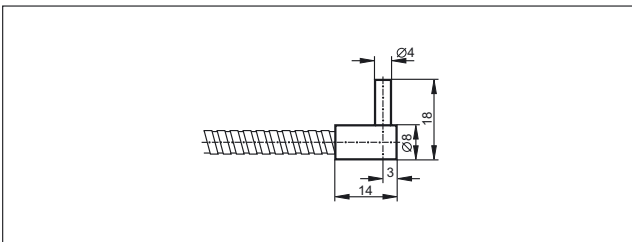

65

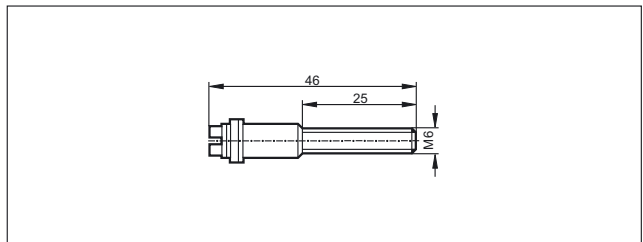

62

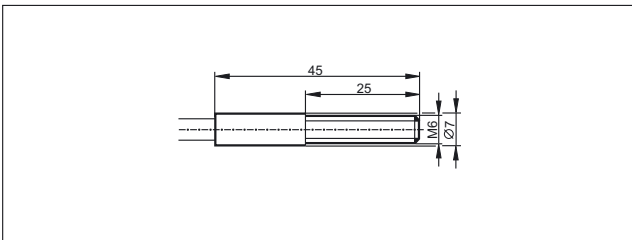





- Photoelectric sensors for specific applications such as transparent objects, low contrast, colour
- Easy pushbutton setting
- Wide range of mounting accessories
- Excellent price / performance ratio

Detection of transparent objects

Counting bottles and glasses or the reliable monitoring of film for tear or web-break is straightforward using specially designed retro-reflective sensors. ifm offers two styles of retro-reflective sensor with a small switching hysteresis especially designed for the detection of transparent objects. With this operating principle, retro-reflective sensors have the advantage that the light beam must pass the object to be detected twice, weakening the light sufficiently to detect a transparent object reliably. Precise adjustment is made by means of the push-button setting.

Low contrast sensor

The O5K low contrast sensor is designed to detect print marks and particularly flat objects. Even pale colours on a light background can be detected. With its RGB transmitter LED the sensor detects even very small differences in contrast. During set-up it automatically selects the optimum transmitter colour from the red green blue (RGB) transmitter to ensure maximum energy difference of the reflected light. In addition, the setting method saves time and money. Pressing the pushbuttons twice is enough for the sensor to be ready for operation.

High-resolution colour sensor

The O5C electronic colour sensor from ifm detects the colour, packaging, label or imprint of objects at a high resolution. With the five selectable tolerance steps, the colour sensor perfectly differentiates even the finest shades of colour from the background or other objects. The unit is set to the colour to be detected by one push of the button.

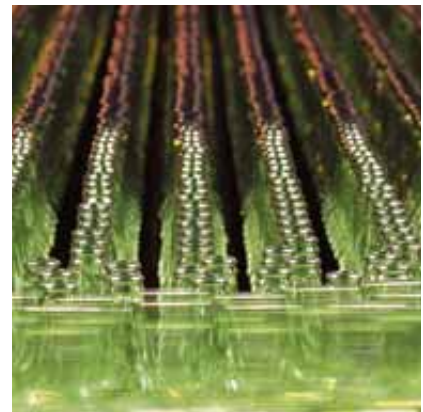



Detection of glass and PET bottles in the beverage industry.

System overview	Page
Sensors for the detection of transparent objects	306
Contrast sensors	306
Sensors for colour detection	307
Rectangular housing O1 for optical level measurement, laser class 2	307
Prismatic reflector	307
Accessories OJ housing	307 - 308
Accessories O5 housing	308 - 309
Accessories for system components	309
Wiring diagrams	309 - 310
Scale drawings / drawing no. – CAD download: www.ifm.com	310 - 311





Sensors for the detection of transparent objects

Type	Operating principle	Range	Type of light	Spot Ø at max. range [mm]	Output H = light-on D = dark-on	Wiring diagr. no.	Draw- ing no.	Order no.
------	---------------------	-------	---------------	---------------------------	---------------------------------------	-------------------------	---------------------	--------------

Retro-reflective sensor · PVC cable 0.15 m · with M12 connector · 10...30 DC · plastics · IP67 · Connector groups 8, 10, 11, 18, 20, 120, 124, 126, 128, 130, 157, 158

	Polarisation filter	0.2...1.5 m	Red	64	H/D PNP	1	1	OJ5191
	Polarisation filter	0.2...1.5 m	Red	64	H/D PNP	1	2	OJ5190

Retro-reflective sensor · M8 connector · 10...30 DC · plastics · IP67 · Connector groups 4, 5, 74, 80, 124

	Polarisation filter	0.2...1.5 m	Red	64	H/D PNP	2	3	OJ5085
	Polarisation filter	0.2...1.5 m	Red	64	H/D PNP	2	4	OJ5086
	Polarisation filter	0.2...1.5 m	Red	64	H/D PNP	2	5	OJ5186
	Polarisation filter	0.2...1.5 m	Red	64	H/D NPN	3	5	OJ5189
	Polarisation filter	0.2...1.5 m	Red	64	H/D PNP	2	6	OJ5185

Retro-reflective sensor · M12 connector · 10...36 DC · plastics · IP67 · Connector groups 10, 12, 13, 18, 19, 20, 21, 120, 122, 124, 126, 128, 130, 132, 157, 159

	Polarisation filter	0...1.5 m	Red	40 / 80	H/D PNP/NPN	5	7	O5G500
---	---------------------	-----------	-----	---------	-------------	---	---	--------

Contrast sensors

Type	Operating principle	Range	Type of light	Spot Ø at max. range [mm]	Output H = light-on D = dark-on	Wiring diagr. no.	Draw- ing no.	Order no.
------	---------------------	-------	---------------	---------------------------	---------------------------------------	-------------------------	---------------------	--------------

M12 connector · 10...36 DC · plastics · IP67 · Connector groups 10, 12, 13, 18, 19, 20, 21, 120, 122, 124, 126, 128, 130, 132, 157, 158, 159

	Diffuse contrast sensor	18...22 mm	RGB	1.5 x 5	H/D PNP/NPN	6	8	O5K500
---	-------------------------	------------	-----	---------	-------------	---	---	--------

Sensors for colour detection

Type	Operating principle	Measuring range	Light spot diameter [mm]	U _b [V]	Current consumption [mA]	Sampling rate / switching frequency [Hz]	Drawing no.	Order no.
------	---------------------	-----------------	-----------------------------	-----------------------	-----------------------------	---	-------------	-----------

M12 connector · Output function light-on / dark-on programmable · DC PNP/NPN · Wiring diagram no. 4 · Connector groups 10, 12, 13, 18, 19, 20, 21, 120, 122, 124, 126, 128, 130, 132, 157, 159

	Colour sensor	15...19 mm	2.5 x 6	10...36	50	2000	8	O5C500
---	---------------	------------	---------	---------	----	------	---	--------

Rectangular housing O1 for optical level measurement, laser class 2

Type	Operating principle	Range	Sampling rate [Hz]	Spot Ø at max. range [mm]	U _b [V]	Wiring diagr. no.	Drawing no.	Order no.
------	---------------------	-------	-----------------------	------------------------------	-----------------------	-------------------	-------------	-----------

Output function OUT1: normally open / closed programmable OUT2: normally open / closed programmable or analogue (4...20 mA / 0...10 V, scalable) · Wiring diagram no. 7 · Connector groups 8, 10, 18, 20, 120, 124, 126, 128, 157

	Optical level sensor	0.2...10 m	1...33	< 15 x 15	18...30	7	9	O1D300
---	----------------------	------------	--------	-----------	---------	---	---	--------

Prismatic reflector

Type	Description	Order no.
------	-------------	-----------

	Prismatic reflector · 48 x 48 mm · rectangular · for retro-reflective laser sensors and glass and film detection · Housing materials: plastics	E20722
---	--	--------

Accessories OJ housing

Type	Description	Order no.
------	-------------	-----------

	Angle bracket · for type OJ · Housing materials: high-grade stainless steel	E20984
---	---	--------







	Basic clip · OJ · Housing materials: high-grade stainless steel	E20965
---	---	--------

	Basic clip · OJ · Housing materials: diecast zinc	E20964
---	---	--------







	Swivel-mount clip · for type OJ · Housing materials: diecast zinc	E20974
---	---	--------



	Mounting set · OJ · for side lens · Clamp mounting · free-standing M8 · Housing materials: fixture: stainless steel 316Ti / 1.4571 / clamp: diecast zinc	E20968
---	--	--------

Position sensors





Type	Description	Order no.
	Mounting set · OJ · for side lens · Clamp mounting · free-standing M8 · Housing materials: fixture: stainless steel 316Ti / 1.4571 / clamp: stainless steel	E20969
	Mounting set · OJ · for side lens · rod mounting Ø 10 mm · Housing materials: clamp: diecast zinc / fixture: stainless steel 316Ti / 1.4571	E21095
	Mounting set · OJ · for side lens · Clamp mounting · rod mounting Ø 10 mm · Housing materials: fixture: stainless steel 316Ti / 1.4571 / clamp: diecast zinc	E21222
	Mounting set · OJ · for side lens · Clamp mounting · rod mounting Ø 10 mm · Housing materials: fixture: stainless steel 316Ti / 1.4571 / clamp: stainless steel	E20973
	Mounting set · OJ · for front lens · Clamp mounting · free-standing M8 · Housing materials: clamp: diecast zinc / fixture: stainless steel 316Ti / 1.4571	E20966
	Mounting set · OJ · for front lens · Clamp mounting · rod mounting Ø 10 mm · Housing materials: fixture: stainless steel 316Ti / 1.4571 / clamp: diecast zinc	E20970
	Mounting set · OJ · for front lens · Clamp mounting · rod mounting · Housing materials: fixture: stainless steel 316Ti / 1.4571 / clamp: stainless steel	E21221

Accessories O5 housing

Type	Description	Order no.
	Angle bracket · for type O5 · Housing materials: stainless steel 316Ti / 1.4571	E21085
	Angle bracket · for type O5 · Housing materials: stainless steel 316Ti / 1.4571	E21087
	Mounting set · Clamp mounting · With protective cover · rod mounting Ø 12 mm · for type O5 · Housing materials: fixture: stainless steel 316Ti / 1.4571 / clamp: high-grade stainless steel	E21223
	Mounting set · Clamp mounting · With protective cover · rod mounting Ø 12 mm · for type O5 · Housing materials: stainless steel 316Ti / 1.4571 / clamp: diecast zinc	E21210
	Mounting set · Clamp mounting · rod mounting Ø 12 mm · for type O5, O5D · Housing materials: stainless steel 316Ti / 1.4571 / clamp: diecast zinc	E21211
	Mounting set · Clamp mounting · rod mounting Ø 12 mm · for type O5, O5D · Housing materials: stainless steel 316Ti / 1.4571 / clamp: high-grade stainless steel	E21212

Type	Description	Order no.
	Mounting brackets Mounting on the back of the unit · for type O5 · Housing materials: stainless steel 316Ti / 1.4571	E21086
	Dovetail clamp · for type DTS, O4, O5 · Housing materials: AlMgSi0.5	E21088

Accessories for system components

Type	Description	Order no.
	mounting rod · Ø 12 / M10 · Length: 130 mm · straight · Housing materials: stainless steel 316Ti / 1.4571	E20938
	mounting rod · Ø 12 / M10 · Length: 200 mm · angled · Housing materials: stainless steel 316Ti / 1.4571	E20940
	Head cap screw · M10 x 120 mm · ISO 4762 (DIN 912) · Free-standing M10 · Housing materials: screw: steel galvanised	E21213
	Head cap screw · M10 x 120 mm · ISO 4762 (DIN 912) · Free-standing M10 · Housing materials: screw: high-grade stainless steel	E21214
	Cube · M10 · aluminium profile · Housing materials: diecast zinc	E20951

Wiring diagrams

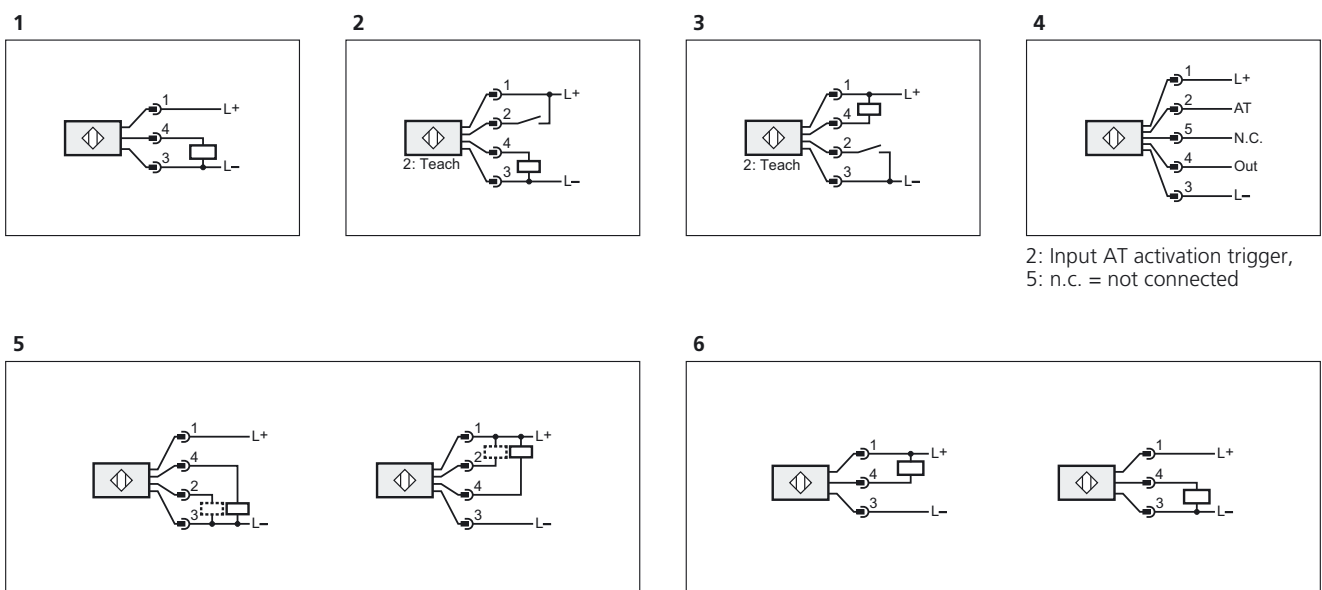

Wiring diagrams

7

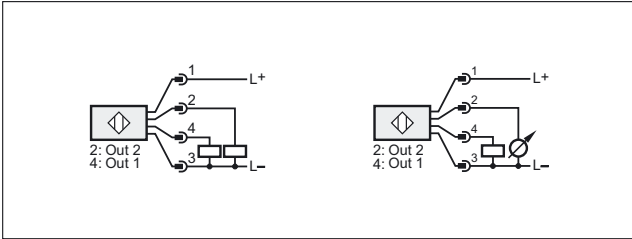

Scale drawings / drawing no. – CAD download: www.ifm.com

1

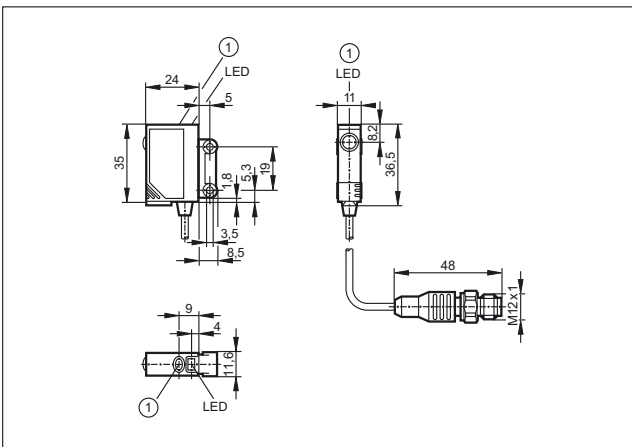

1: pushbutton

3

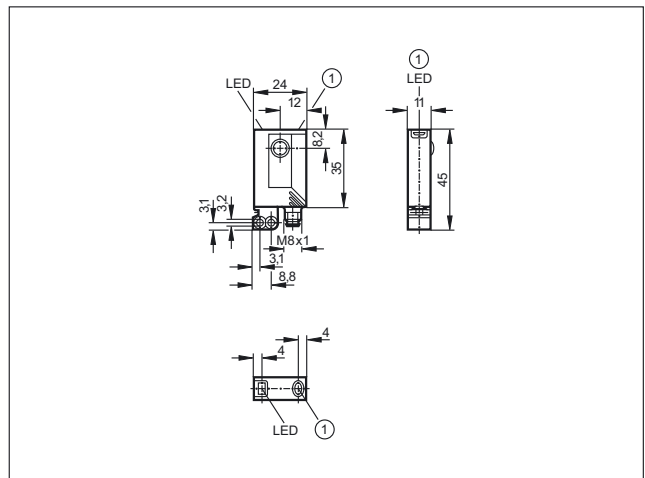

1: pushbutton

2

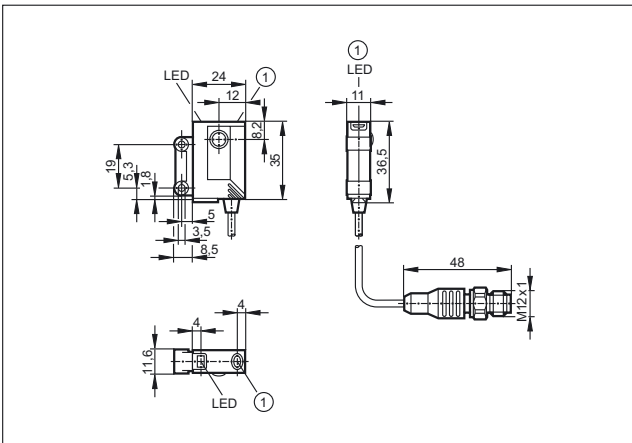

1: pushbutton

4

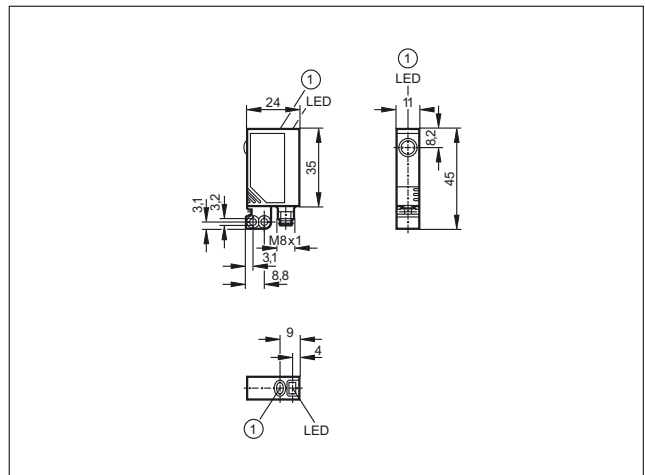

1: pushbutton

Scale drawings / drawing no. – CAD download: www.ifm.com

5

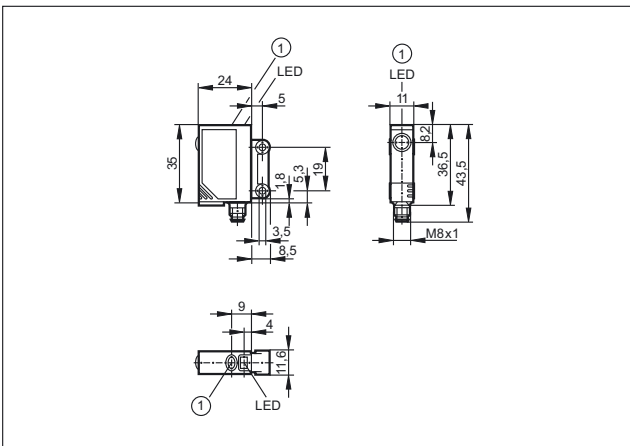

1: pushbutton

6

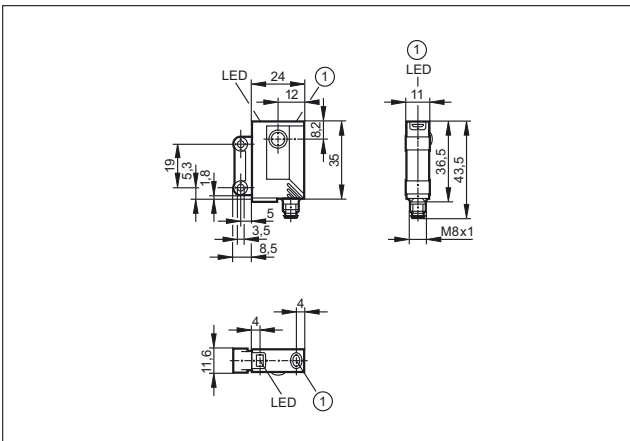

1: pushbutton

7

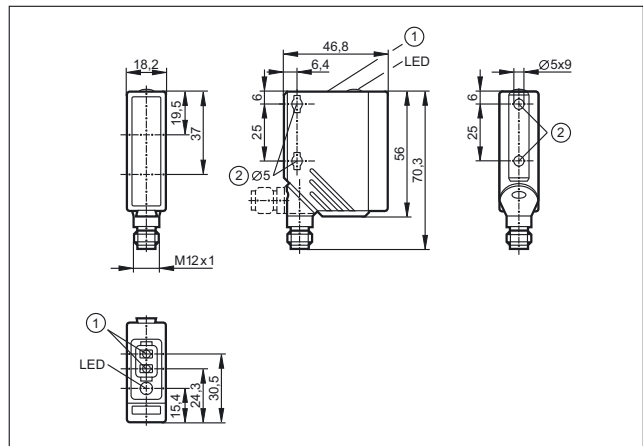

1: Programming buttons, 2: When a M5 mounting screw is used, the max. tightening torque is 2 Nm.

8

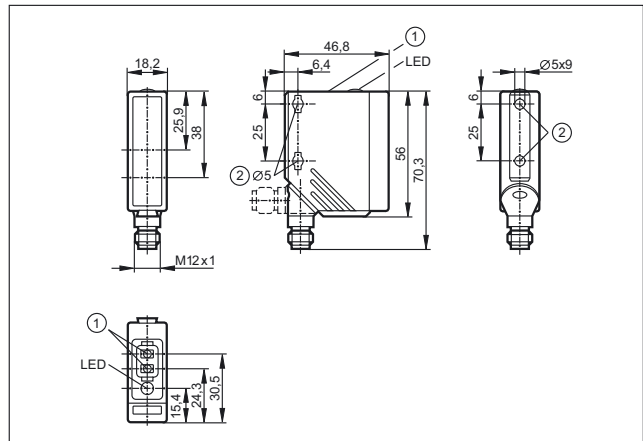

1: Programming buttons, 2: When a M5 mounting screw is used, the max. tightening torque is 2 Nm.

9

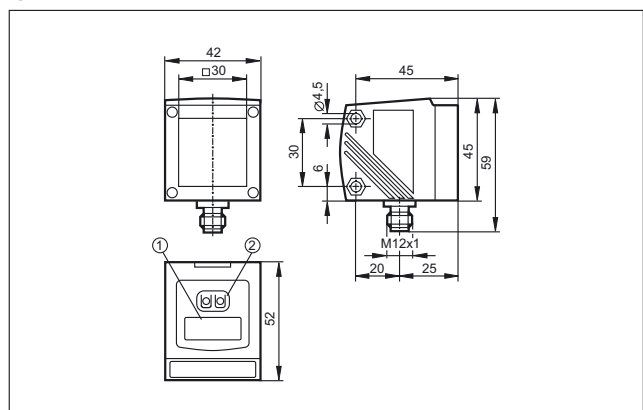

1: 4-digit alphanumeric display, 2: Programming buttons



- Dual inductive feedback sensors for pneumatic actuators and valves
- Designed for simple fit to common actuators based on VDI / VDE 3845
- AS-i versions for even simpler and neater wiring
- Compact, weatherproof and low maintenance
- Mounting sets available for manual valves and non-standard actuators

Valve sensors

Butterfly and ball valves in a variety of specifications are common across a broad spectrum of industrial processes. A large proportion of these have been automated with the addition of a pneumatic actuator to drive the valve between its open and closed positions. Feedback can then be added to confirm that the valve has achieved its desired position. This often takes the form of a rotating cam arrangement with a couple of microswitches or small inductive sensors mounted inside a plastic switch box. Such switch boxes can be difficult to set up, suffer from ingress and the cams can sometimes slip under normal plant vibration.

Operating principle

In 1992 ifm electronic released our first alternative to this old and failure prone design. The IND dual sensor is essentially a pair of inductive sensors, operating at different frequencies so as not to interfere with each other, combined into a custom design housing which mechanically matches the top works on standard pneumatic actuators. The dual sensor fits neatly onto the actuator's existing M5 holes. A plastic target "puck" is then fitted onto the slotted actuator shaft, again using the existing threaded hole. The puck has two metal targets spaced 90 degrees apart which are picked up by either the OPEN sensor or the CLOSED sensor.

Advantages

This simple construction addresses all the shortcomings of the switchbox solution. It is weatherproof surviving heavy rain, ice and strong sunshine. It is low profile allowing valve / actuator packages to fit where a switchbox would not. This also means that feedback can be fitted to even small manually operated valves. It is low weight so will not fail even if pumps are causing pipe vibration. It allows for back wiring a local solenoid through the common multi-pin connector, saving on wiring and cable tray costs.









Feedback: Position monitoring of both pneumatically actuated and manual valves is needed for plant control.

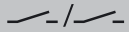
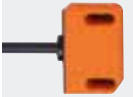
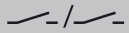
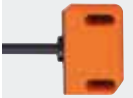
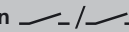
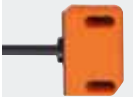



System overview	Page
Sensors for industrial applications	314 - 315
Sensors for industrial applications, AS-i system	315
Sensors with ATEX approval 1G / 2G and 1D	316
Sensors with ATEX approval 3D and / or 3G	317
Sensors for rising stem valves	317
Sensors for rising stem valves, AS-i system	318
Added value packages with Bürkert solenoid valve	318
Added value packages with Norgren Herion solenoid valve	318
Switching cams for sensors with quarter-turn actuators	318 - 320
Accessories for quarter-turn actuator sensors	320 - 321
Accessories for rising stem valve sensors	321
Wiring diagrams	321 - 322
Scale drawings / drawing no. – CAD download: www.ifm.com	322 - 325



Sensors for industrial applications

Type	Dimensions [mm]	Sensing range [mm]	Material	U _b [V]	Protection	f AC / DC [Hz]	I _{load} AC / DC [mA]	Draw- ing no.	Order no.
Cable 2 m · Output function  · DC PNP · Wiring diagram no. 1									
	40 x 26 x 26	4 nf	PBT	10...36	IP 67	1300	250	1	IN5251
Cable 6 m · Output function  · DC PNP · Wiring diagram no. 1									
	40 x 26 x 26	4 nf	PC (polycarbonate)	10...36	IP 67	1300	250	1	IN5304
Cable 10 m · Output function  · DC PNP · Wiring diagram no. 1									
	40 x 26 x 26	4 nf	PBT	10...36	IP 67	1300	250	1	IN5323
Cable 2 m · Output function  · AC/DC · Wiring diagram no. 2									
	40 x 26 x 40	4 nf	PBT	20...250	IP 67	25 / 50	250 / 100	2	IN0110*
M12 connector · Output function  · DC PNP/NPN · Wiring diagram no. 13 · Connector groups 8, 10, 18, 20, 120, 124, 126, 128, 157									
	40 x 26 x 26	4 nf	PBT	10...36	IP 67	1300	250	3	IN5224
M12 connector · Output function  · DC PNP/NPN · Wiring diagram no. 3 · Connector groups 8, 10, 18, 20, 120, 124, 126, 128, 157									
	40 x 26 x 47	4 nf	PBT	10...36	IP 67	250	250	4	IN5331
M12 connector · Output function  · DC PNP · Wiring diagram no. 4 · Connector groups 8, 9, 10, 11, 18, 20, 120, 124, 126, 128, 130, 131, 157, 158									
	40 x 26 x 26	4 nf	PBT	10...36	IP 67	1300	250	3	IN5225
	40 x 26 x 47	4 nf	PBT	10...36	IP 67	1300	250	4	IN5327
M18 connector · Output function  · DC PNP · Wiring diagram no. 4 · Connector group 24									
	40 x 26 x 26	4 nf	PBT	10...36	IP 67	1300	250	5	IN5285

Type	Dimensions [mm]	Sensing range [mm]	Material	U _b [V]	Protection	f AC / DC [Hz]	I _{load} AC / DC [mA]	Draw- ing no.	Order no.
------	--------------------	--------------------------	----------	-----------------------	------------	----------------------	--------------------------------------	---------------------	--------------

M18 connector · Output function  /  · AC/DC · Wiring diagram no. 5 · Connector group 24

	40 x 26 x 40	4 nf	PBT	20...250	IP 67	25 / 50	250 / 100	6	IN0108*
---	--------------	------	-----	----------	-------	---------	-----------	---	---------

Rd 24 x 1/8 connector 6 pins · Output function  /  · DC PNP · Connector groups 34, 40, 135, 136

	40 x 26 x 60	4 nf	PBT	10...36	IP 67	1300	250	7	IN5334
---	--------------	------	-----	---------	-------	------	-----	---	--------

Terminals · Output function  /  · DC PNP · Wiring diagram no. 14

	33 x 60 x 92	4 nf	PA (polyamide)	10...30	IP 67	500	100	8	IN5409
---	--------------	------	----------------	---------	-------	-----	-----	---	--------

f = flush / nf = non flush

*** Note for AC and AC/DC units**

Miniature fuse to IEC60127-2 sheet 1, ≤ 2 A (fast acting) Recommendation: check the unit for reliable function after a short circuit.

Sensors for industrial applications, AS-i system

Type	Dimensions [mm]	Sensing range [mm]	Material	U _b [V]	Protection	f AC / DC [Hz]	I _{load} AC / DC [mA]	Draw- ing no.	Order no.
------	--------------------	--------------------------	----------	-----------------------	------------	----------------------	--------------------------------------	---------------------	--------------

M12 connector · 1 x 2 inputs · Wiring diagram no. 6 · Connector groups 10, 12, 13, 18, 19, 20, 21, 120, 122, 124, 126, 128, 132, 157, 159

	55 x 60 x 35	4 nf	PBT (Pocan)	26.5...31.6	IP 67	–	–	9	AC2315
---	--------------	------	-------------	-------------	-------	---	---	---	--------

M12 connector · Output function transistor PNP · 2 inputs / 1 output · Connector groups 8, 10, 18, 20, 40, 120, 124, 126, 128, 135, 136, 157







	55 x 60 x 35	4 nf	PBT (Pocan)	26.5...31.6	IP 67	–	–	10	AC2316
---	--------------	------	-------------	-------------	-------	---	---	----	--------

M12 connector · Output function transistor PNP · 2 inputs / 2 outputs · Connector groups 8, 10, 18, 20, 40, 120, 124, 126, 128, 135, 136, 157

	55 x 60 x 35	4 nf	PBT (Pocan)	26.5...31.6	IP 67	–	–	10	AC2317
---	--------------	------	-------------	-------------	-------	---	---	----	--------

f = flush / nf = non flush

Sensors with ATEX approval 1G / 2G and 1D

Type	Dimensions [mm]	Sensing range [mm]	Material	U _{nom.} at 1 KΩ [V]	U _b [V]	Internal capacit. [nF]	Internal inductance [μH]	f [Hz]	Drawing no.	Order no.
M12 connector · Output function 2 x normally closed · Connection to certified intrinsically safe circuits with the max. values U = 15 V / I = 50 mA / P = 120 mW · Wiring diagram no. 7 · Connector group 153										
	40 x 26 x 26	4 nf	PBT	8.2 DC	7.5...15 DC	140	130	1800	11	NN5008
Cable 2 m · Output function 2 x normally closed · Connection to certified intrinsically safe circuits with the max. values U = 15 V / I = 50 mA / P = 120 mW · Wiring diagram no. 8										
	40 x 26 x 26	4 nf	PBT	8.2 DC	7.5...15 DC	140	130	1800	1	NN5009
Cable 10 m · Output function 2 x normally closed · Connection to certified intrinsically safe circuits with the max. values U = 15 V / I = 50 mA / P = 120 mW · Wiring diagram no. 8										
	40 x 26 x 26	4 nf	PBT	8.2 DC	7.5...15 DC	140	140	1800	1	NN5011
M18 connector · Output function 2 x normally closed · Connection to certified intrinsically safe circuits with the max. values U = 15 V / I = 50 mA / P = 120 mW · Wiring diagram no. 9 · Connector group 24										
	40 x 26 x 26	4 nf	PBT	8.2 DC	7.5...15 DC	140	130	1800	5	NN5013
Rd 24 x 1/8 connector 6 pins · Output function 2 x normally closed · Connection to certified intrinsically safe circuits with the max. values U = 15 V / I = 50 mA / P = 120 mW · Connector groups 34, 56, 64, 107, 108, 109, 110, 111, 112, 137, 152										
	40 x 26 x 60	4 nf	PBT	8.2 DC	–	150	150	250	7	N95001
	40 x 26 x 60	4 nf	PBT	8.2 DC	–	100	150	1300	7	N95002
Terminals · Output function 2 x normally closed · Connection to certified intrinsically safe circuits with the max. values U = 15 V / I = 50 mA / P = 120 mW · Wiring diagram no. 15										
	33 x 60 x 92	4 nf	PA (polyamide)	8.2 DC	7.5...15 DC	–	–	500	8	NN504A
Terminals · Output function 2 x normally closed · Connection to certified intrinsically safe circuits with the max. values U = 15 V / I = 50 mA / P = 120 mW · Wiring diagram no. 16 · Connector group --										
	33 x 60 x 92	4 nf	PA (polyamide)	8.2 DC	7.5...15 DC	–	–	500	12	NN505A

f = flush / nf = non flush

Sensors with ATEX approval 3D and / or 3G

Type	Dimensions [mm]	Sensing range [mm]	Material	U _b [V]	Protection	f AC / DC [Hz]	I _{load} AC / DC [mA]	Draw- ing no.	Order no.
------	--------------------	--------------------------	----------	-----------------------	------------	----------------------	--------------------------------------	---------------------	--------------

M12 connector · Output function transistor PNP · 2 inputs / 2 outputs · Connector groups 154, 156

	55 x 60 x 35	4	PBT	26.5...31.6	IP 5x	–	–	13	AC327A
---	--------------	---	-----	-------------	-------	---	---	----	--------

M12 connector · Output function transistor PNP · 2 inputs / 1 output · Connector groups 154, 156

	55 x 60 x 35	4	PBT	26.5...31.6	IP 5x	–	–	13	AC336A
	55 x 60 x 35	4	PBT (Pocan)	26.5...31.6	IP 67	–	–	13	AC326A

M12 connector · Output function  · DC PNP · Wiring diagram no. 4 · Connector groups 154, 156

	40 x 26 x 47	4	PBT	10...30	IP 67	1300	100	14	IN507A
--	--------------	---	-----	---------	-------	------	-----	----	--------

Cable 2 m · Output function  · DC PNP · Wiring diagram no. 1

	40 x 26 x 26	4	PBT	10...30	IP 67	1300	100	15	IN512A
---	--------------	---	-----	---------	-------	------	-----	----	--------

Sensors for rising stem valves

Type	Dimensions [mm]	Sensing range [mm]	Material	U _b [V]	Protection	f AC / DC [Hz]	I _{load} AC / DC [mA]	Draw- ing no.	Order no.
------	--------------------	--------------------------	----------	-----------------------	------------	----------------------	--------------------------------------	---------------------	--------------

Cable 2 m · Output function 1...5 V analogue · DC · Wiring diagram no. 10

	67.5 x 43 x 110	–	PA	18...36	IP 65 / IP 67	–	–	16	IX5002
---	-----------------	---	----	---------	---------------	---	---	----	--------

Cable 2 m · Output function 3 x normally open · DC PNP · Wiring diagram no. 11

	67.5 x 43 x 110	–	PA	18...36	IP 65 / IP 67	–	100	17	IX5006
---	-----------------	---	----	---------	---------------	---	-----	----	--------

Cable with connector 0.3 m · Output function 3 x normally open · DC PNP · Wiring diagram no. 12 · Connector groups 122, 126, 128, 132, 159

	65 x 52 x 110	–	PA	18...36	IP 65 / IP 67	–	100	18	IX5010
---	---------------	---	----	---------	---------------	---	-----	----	--------

	65 x 43 x 110	0.2	PA	18...36	IP 65 / IP 67	–	100	19	ZZ0214
---	---------------	-----	----	---------	---------------	---	-----	----	--------

Sensors for rising stem valves, AS-i system

Type	Dimensions [mm]	Sensing range [mm]	Material	U _b [V]	Protection	f AC / DC [Hz]	I _{load} AC / DC [mA]	Drawing no.	Order no.
------	--------------------	-----------------------	----------	-----------------------	------------	----------------------	--------------------------------------	-------------	-----------

Cable with connector 0.15 m · AS-i · Wiring diagram no. 6 · Connector groups 10, 12, 13, 18, 19, 20, 21, 120, 122, 124, 126, 128, 132, 157, 159

	65 x 52 x 110	–	PA	26.5...31.6	IP 65 / IP 67	–	–	18	IX5030
---	---------------	---	----	-------------	---------------	---	---	----	--------

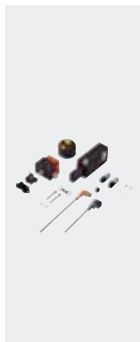

Added value packages with Bürkert solenoid valve



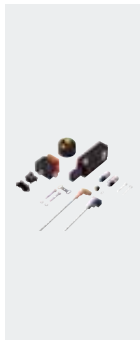



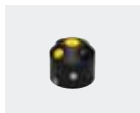







Type	Description	Order no.
	Added value package AS-i for pneumatic quarter-turn actuators · A/B slave · Shaft height 20 mm · Hole spacing 80 mm · Connector	AC0017
	Added value package AS-i for pneumatic quarter-turn actuators · A/B slave · Shaft height 30 mm · Hole spacing 80 mm · Connector	AC0019
	Added value package AS-i for pneumatic quarter-turn actuators · A/B slave · Shaft height 30 mm · Hole spacing 130 mm · Connector	AC0020

Added value packages with Norgren Herion solenoid valve





Type	Description	Order no.
	Added value package AS-i for pneumatic quarter-turn actuators · A/B slave · Shaft height 20 mm · Hole spacing 80 mm · Connector	AC0021
	Added value package AS-i for pneumatic quarter-turn actuators · A/B slave · Shaft height 30 mm · Hole spacing 80 mm · Connector	AC0022
	Added value package AS-i for pneumatic quarter-turn actuators · A/B slave · Shaft height 30 mm · Hole spacing 130 mm · Connector	AC0023

Switching cams for sensors with quarter-turn actuators



Type	Description	Order no.
	Target puck · Ø 53 mm · The upper damping level is 360° continuously adjustable · Housing materials: Target puck: PVC / screws: high-grade stainless steel	E10661
	Target puck · Ø 53 mm · 6 possible switching flag positions · with drain holes · Housing materials: Target puck: PA 6 / screws: high-grade stainless steel	E17105

Type	Description	Order no.
	Target puck · Ø 53 mm · Housing materials: Target puck: PBT / screws: high-grade stainless steel	E17118
	Target puck · Ø 53 mm · 8 possible switching flag positions · with drain holes · Housing materials: Target puck: PA 6 / screws: high-grade stainless steel	E17294
	Target puck · Ø 53 mm · 3 possible switching flag positions · Housing materials: Target puck: PA 6 black / screws: V2A	E17320
	Target puck · Ø 53 mm · 8 possible switching flag positions · Housing materials: Target puck: PA 6 black / screws: V2A	E17321
	Target puck · Ø 53 mm · Housing colour: blue · 8 possible switching flag positions · Housing materials: Target puck: PA 6 blue / screws: V2A	E17322
	Target puck · Ø 53 mm · Housing colour: red · 8 possible switching flag positions · Housing materials: Target puck: PA 6 / screws: V2A	E17323
	Target puck · Ø 55 mm · Inverted function · Housing materials: Target puck: PVC / screws: high-grade stainless steel / Metal ring: stainless steel	E17205
	Target puck · Ø 59 mm · for Neles actuator type B1CU 6/20E · Housing materials: Target puck: POM	E11278
	Target puck · Ø 65 mm · Housing materials: Target puck: PVC / screws: high-grade stainless steel	E17148
	Target puck · Ø 65 mm · Housing colour: black · 8 possible switching flag positions · Housing materials: Target puck: PA 6 / screws: V2A	E17324
	Target puck · Ø 65 mm · Housing colour: blue · 8 possible switching flag positions · Housing materials: Target puck: PA 6 / screws: V2A	E17325
	Target puck · Ø 65 mm · Housing colour: red · 8 possible switching flag positions · Housing materials: Target puck: PA 6 / screws: V2A	E17326
	Target puck · Ø 65 mm · Housing materials: Target puck: PA 6 / screws: V2A	E17327
	Target puck · Ø 102 mm · Housing materials: Target puck: PA 6 / screws: V2A	E17328
	Target puck · Ø 102 mm · Housing colour: black · 8 possible switching flag positions · Housing materials: Target puck: PA 6 / screws: V2A	E17329

Position sensors

Type	Description	Order no.
	Target puck · Ø 102 mm · Housing colour: blue · 8 possible switching flag positions · Housing materials: Target puck: PA 6 / screws: V2A	E17330
	Target puck · Ø 102 mm · Housing colour: red · 8 possible switching flag positions · Housing materials: Target puck: PA 6 / screws: V2A	E17331
	direction indicator black · 12 x 4.8 · For target puck · Housing materials: POM	E17295
	direction indicator yellow · 12 x 4.8 · For target puck · Housing materials: POM	E17296

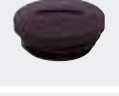
Accessories for quarter-turn actuator sensors

Type	Description	Order no.
	Spacer · 10 mm · for compensation between target pucks and dual sensor IND · Housing materials: PBT	E10579
	Spacer · 3 mm · for compensation between target pucks and dual sensor IND · Housing materials: PBT	E10584
	Spacer · 5 mm · for compensation between target pucks and dual sensor IND · Housing materials: PBT	E10585
	Cable gland · M20 x 1.5 · Housing materials: PA 6.6	E12208
	Protective cap · M20 x 1.5 · Housing materials: PA 6.6	E12209
	Plug for covering the oblong holes · Housing materials: EPDM	E12212
	reinforcement bracket · for type IND · Housing materials: stainless steel 316Ti / 1.4571	E11310
	protective housing · Accessory for valve sensors · for type IND · Housing materials: stainless steel	E11984
	Mounting kit · MS-MEC-KU-RA--F04A · for ball valve Mecafrance ISO5211/F04 DN25 PN40 · Detection of the "ON/OFF" position by means of the IND dual sensor	E10597

Type	Description	Order no.
------	-------------	-----------



Mounting kit for limit position feedback · tyco 792E-100 · for Keystone actuators

E11243

Accessories for rising stem valve sensors

Type	Description	Order no.
------	-------------	-----------



Mounting adapter · for Kieselmann seat valves · accessory for IX5010, IX5030 · Housing materials: adapter: PA / target: stainless steel 316L / 1.4404

E12123



Mounting adapter · for Alfa Laval valves · accessory for IX5010, IX5030 · Housing materials: adapter: PA / target: stainless steel 316L / 1.4404

E11900



Mounting adapter · for Südmo valves · accessory for IX5010, IX5030 · Housing materials: adapter: PA / target: stainless steel 316L / 1.4404

E11989



Mounting adapter · for Georg Fischer diaphragm valve Diastar with mounting kit M12 · accessory for IX5010, IX5030 · Housing materials: adapter: POM / target: stainless steel

E12009



Mounting adapter · for Georg Fischer diaphragm valve Diastar with mounting kit M16 · accessory for IX5010, IX5030 · Housing materials: adapter: POM / target: stainless steel

E12010



Mounting adapter · for Bardiani valves · accessory for IX5010, IX5030 · Housing materials: adapter: PA / target: stainless steel 316L / 1.4404

E12170



Mounting adapter · IX / Ø 30 mm · for Gemü actuators with mounting kit · accessory for IX5010, IX5030 · Housing materials: adapter: POM / target: stainless steel

E12042



Mounting adapter · IX / Ø 45 mm · for Gemü actuators with mounting kit · accessory for IX5010, IX5030 · Housing materials: adapter: POM / target: stainless steel

E12043

Wiring diagrams

Core colours

BN brown
BU blue
BK black
WH white
GY grey

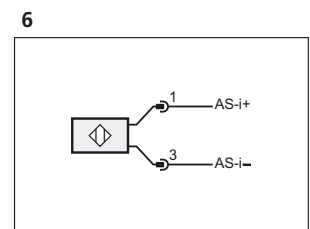
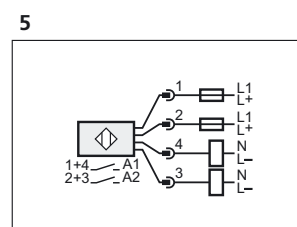
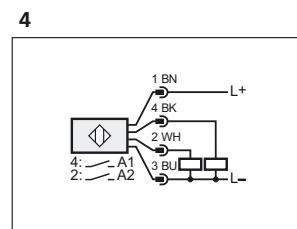
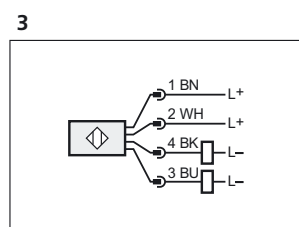
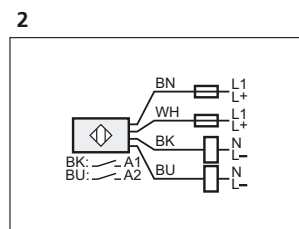
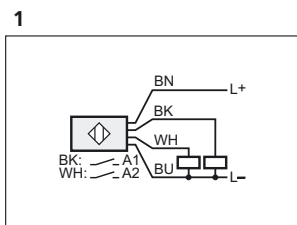

Wiring diagrams

7

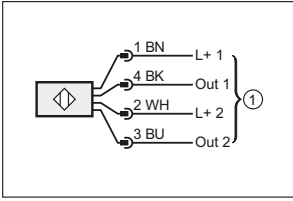

1: connection to NAMUR-amplifier

8

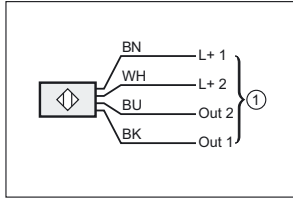

1: connection to NAMUR-amplifier

9

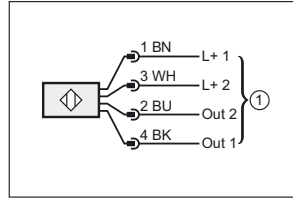

1: connection to NAMUR-amplifier

11

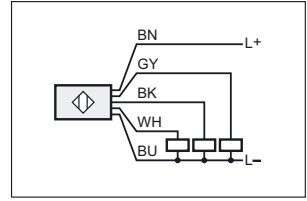

12

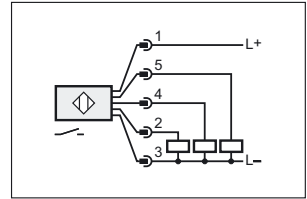

10

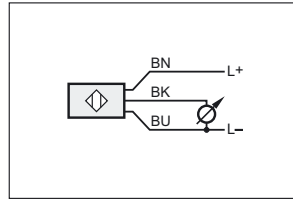

13

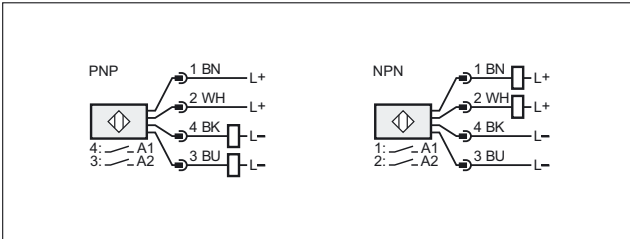

15

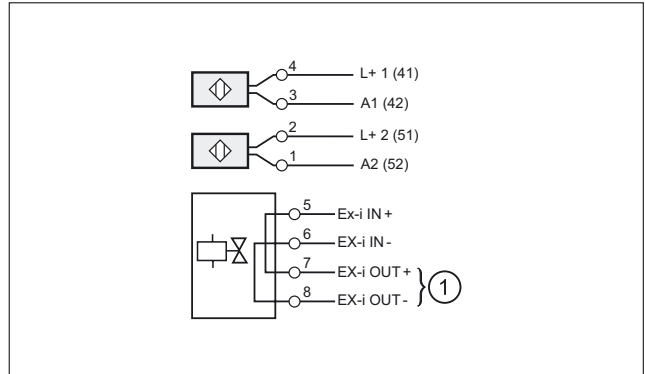

14

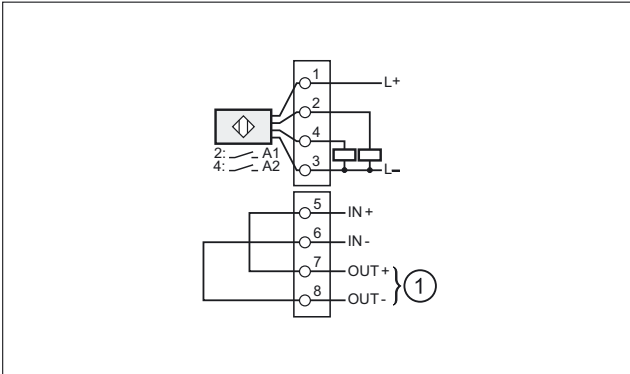

1: solenoid valve

16

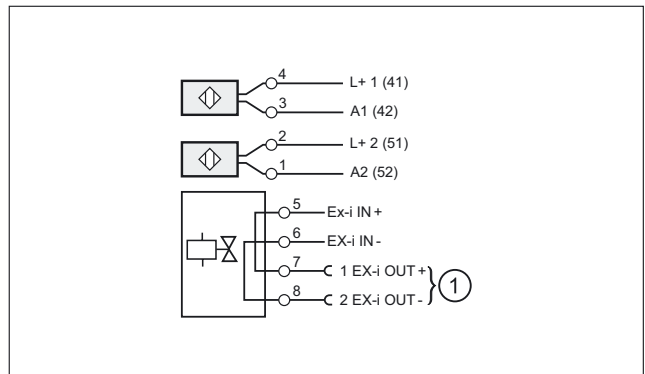

Scale drawings / drawing no. – CAD download: www.ifm.com

1

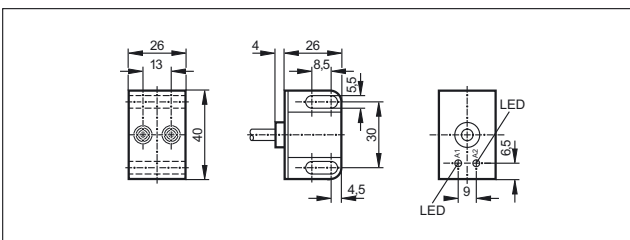

2

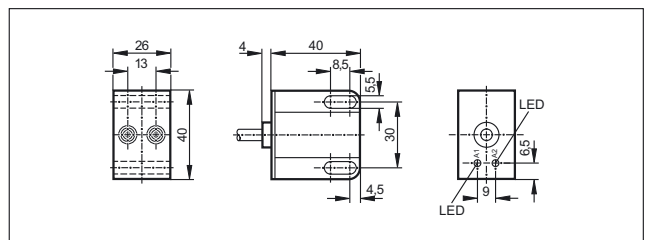

Scale drawings / drawing no. – CAD download: www.ifm.com

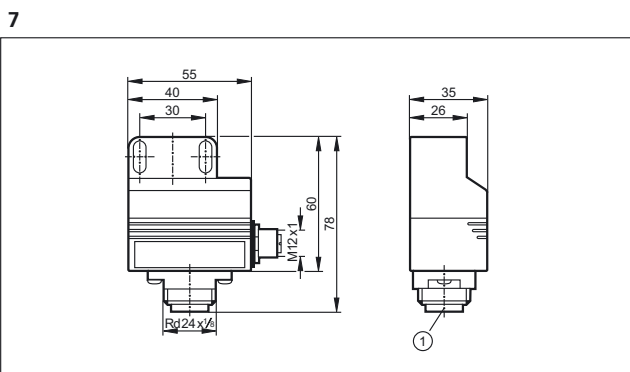
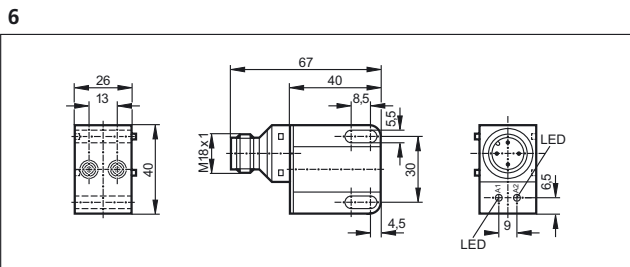
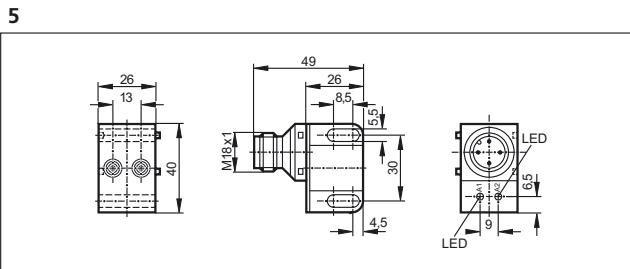
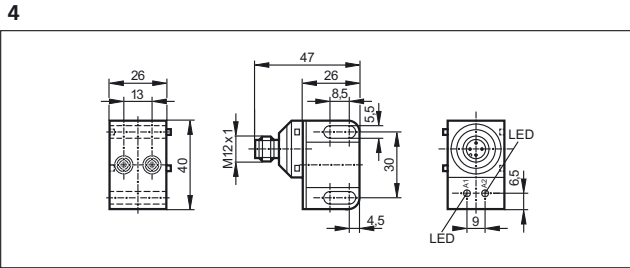
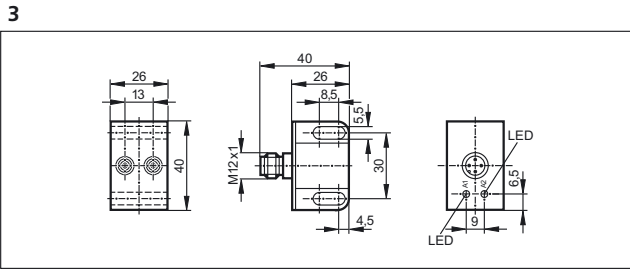

1: field connection

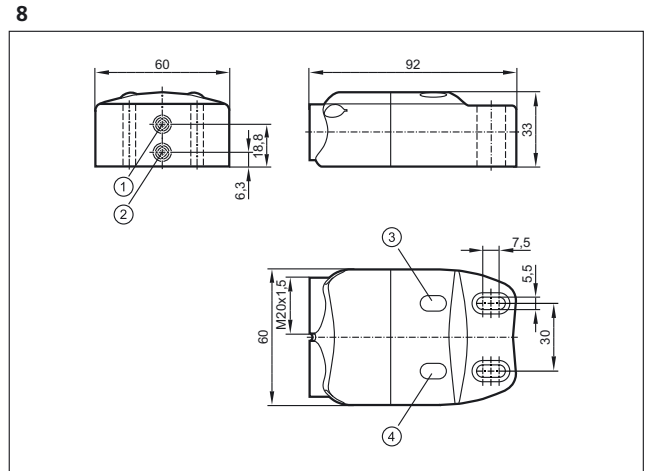

1: sensor 1, 2: sensor 2, 3: LED OUT 2, 4: LED OUT 1

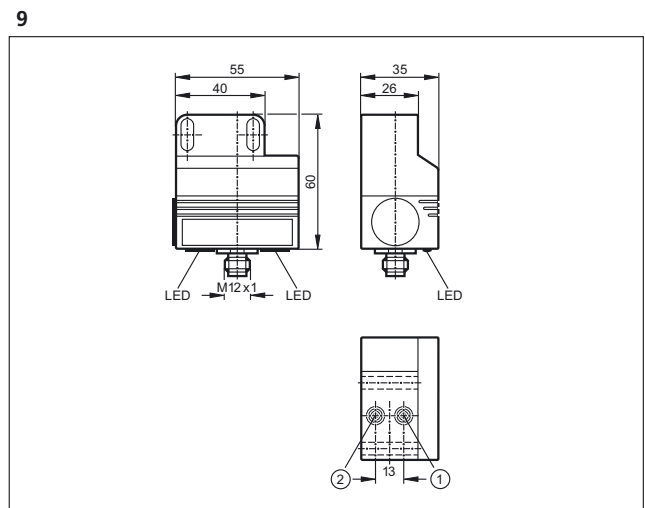

1: sensor 1, 2: sensor 2

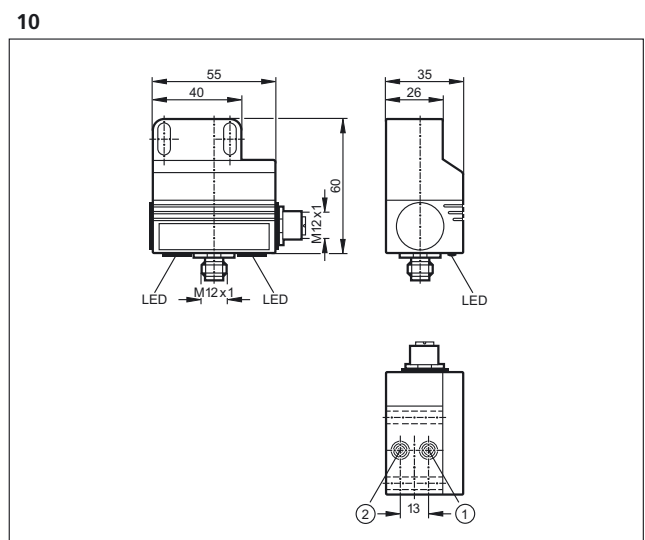

1: sensor 1, 2: sensor 2

Scale drawings / drawing no. – CAD download: www.ifm.com

11

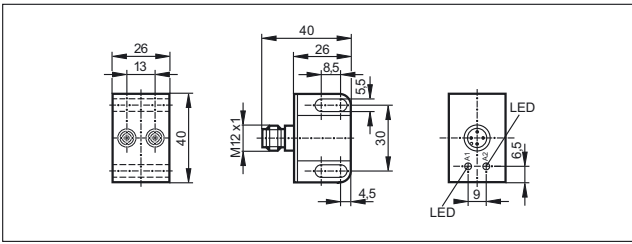

12

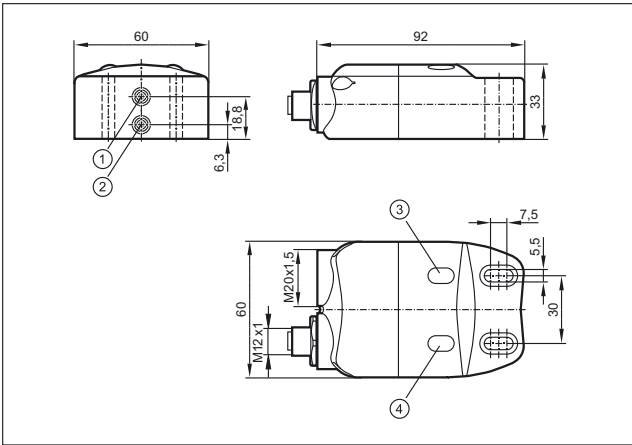

1: sensor 1, 2: sensor 2, 3: LED OUT 2, 4: LED OUT 1

13

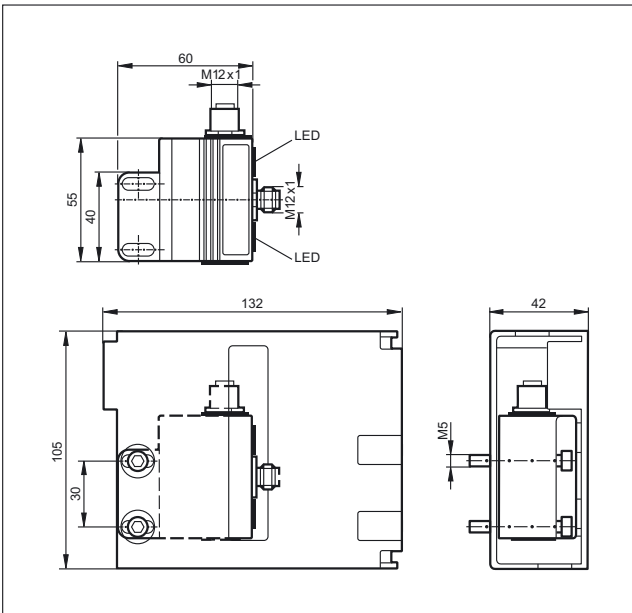

14

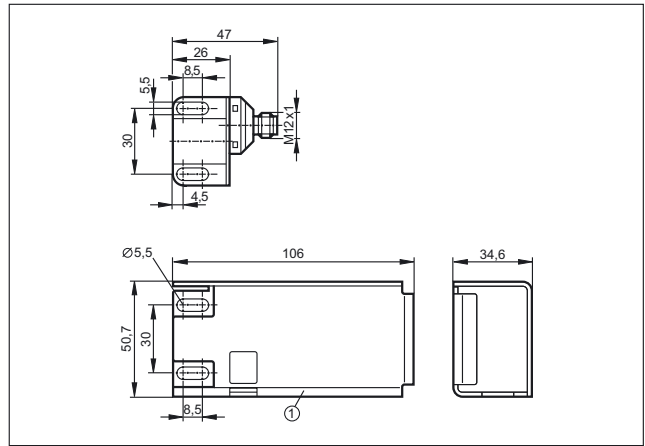

1: protective housing

15

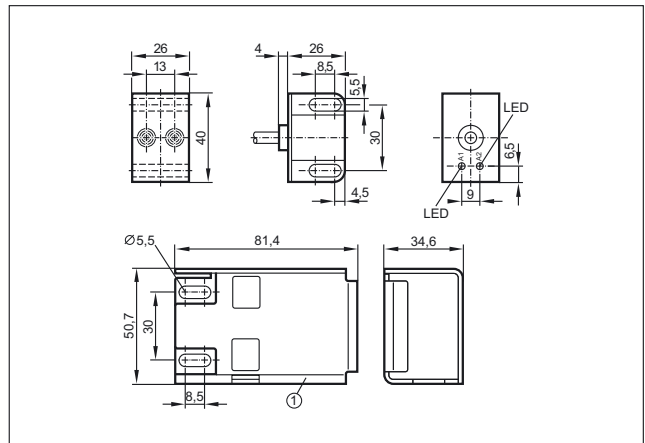

16

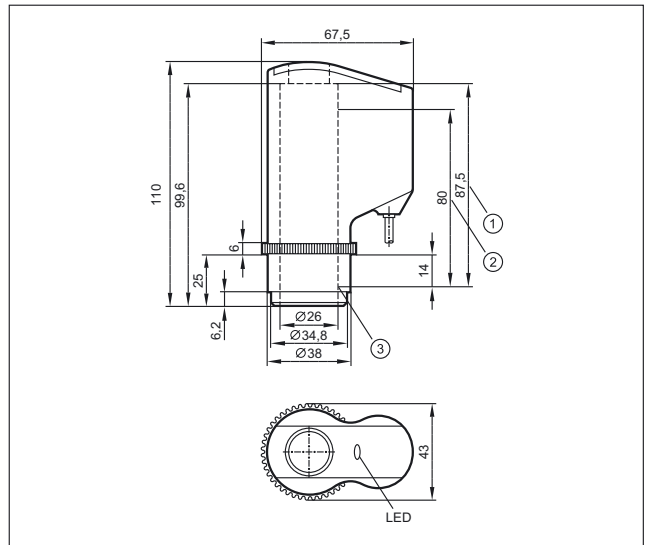

1: Max. spindle stroke, 2: Measuring range, 3: Initial value of the measuring range (zero point)

Scale drawings / drawing no. – CAD download: www.ifm.com

17

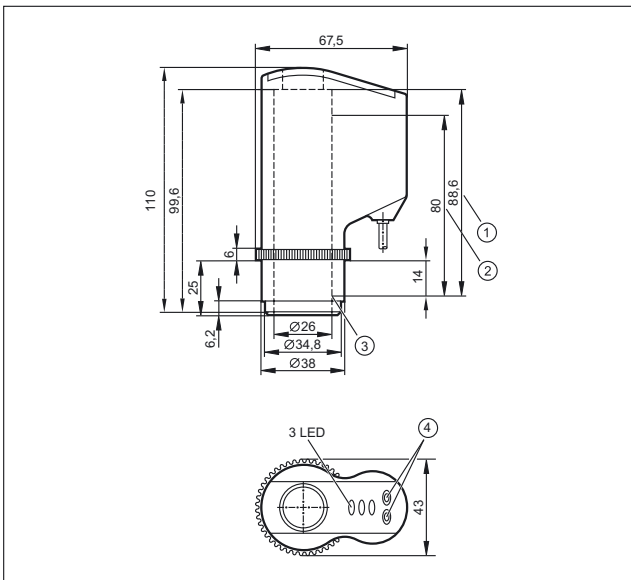

1: Max. spindle stroke, 2: Measuring distance, 3: Initial value of the measuring range (zero point), 4: Programming buttons

18

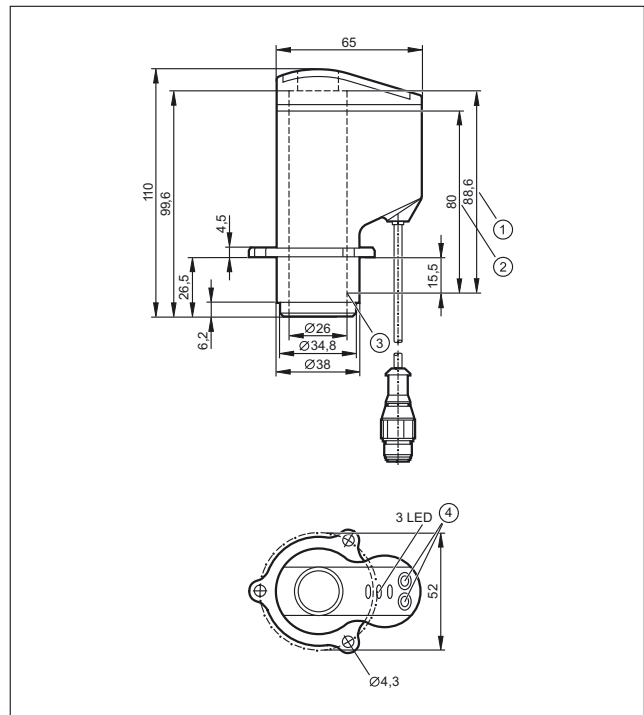

1: Max. spindle stroke, 2: Measuring distance, 3: Initial value of the measuring range (zero point), 4: Programming buttons

19

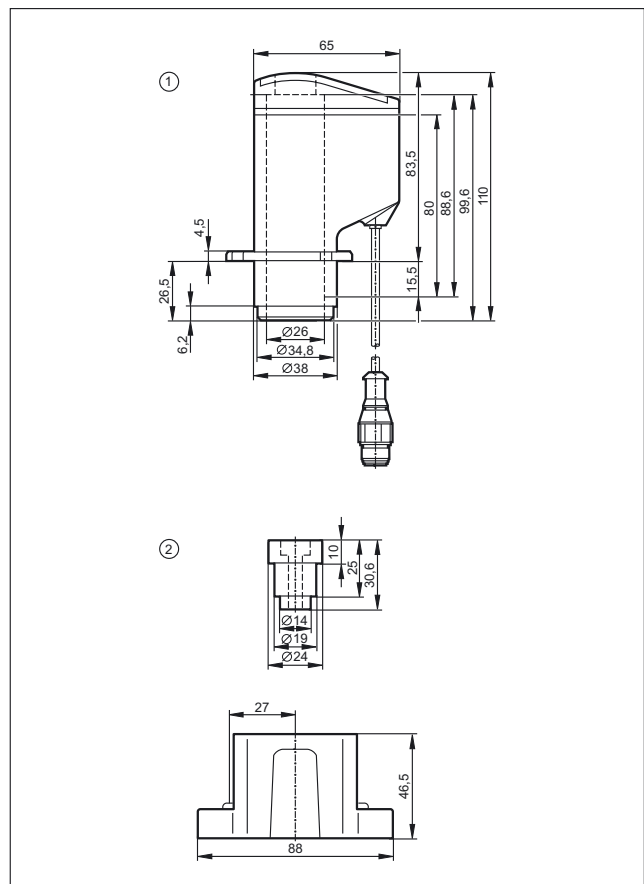

1: Valve sensor IX5010, 2: Mounting adapter E11900



- One or two-channel NAMUR switching amplifiers to IEC 60947-5-6
- Short-circuit and wire-break monitoring
- Programmable output function
- Relay or transistor outputs
- Easy mounting on DIN rail

Hazardous gas and dust areas

ATEX stands for "atmosphère explosible". The 94/9/EC and 1999/92/EC directives are also commonly called "ATEX directives". Potentially explosive atmospheres arise in most industries. ifm electronic can supply sensing equipment for all three unit categories each for gas and dust (1 - 3) that are analogous to the gas zones 0 / 1 / 2 or dust zones 20 / 21 / 22.

NAMUR switching amplifiers for hazardous areas

The NAMUR switching amplifiers evaluate the sensor signal and control the output. They meet all requirements of the ATEX directives. Switching amplifiers with relay and transistor output are available. The switching amplifiers are designed for the connection of NAMUR sensors to IEC 60947-5-6 and mechanical switches. They provide the voltage supply via an electrical separation for the intrinsically safe circuit.

Further features of the switching amplifiers are:

- Programmable effective direction of the output
- Relay output designed as changeover contact
- Short-circuit proof transistor outputs
- The sensor cables are monitored for wire break and short circuit. In case of a fault, the output is blocked or the relay is de-energised.



Typical hazardous gas areas are found in the chemical industry, for example in gas and petroleum processing.

Examples for the hazardous dust areas are the food and feedstuffs industries, but also disposal and recycling operations.



<i>System overview</i>	<i>Page</i>
Switching amplifiers with ATEX approval	328
Scale drawings / drawing no. – CAD download: www.ifm.com	328

Switching amplifiers with ATEX approval

Type	U _b [V]	Power / current consumption [VA] / [mA]	f [Hz]	T _a [°C]	Output	Protection	Drawing no.	Order no.
	115	1.0 /	10	-20...60	relay (1 changeover contact)	IP 20	1	N0030A
	230	1.0 /	10	-20...60	relay (1 changeover contact)	IP 20	1	N0031A
	115	1.3 /	10	-20...60	relay (1 changeover contact per channel)	IP 20	1	N0032A
	230	1.3 /	10	-20...60	relay (1 changeover contact per channel)	IP 20	1	N0033A
	24	/ < 23	10	-20...60	relay (1 changeover contact)	IP 20	1	N0530A
	24	/ < 50	5000	-20...60	2 transistor outputs PNP (100 mA, short-circuit protection)	IP 20	1	N0531A
	24	/ < 50	5000	-20...60	2 outputs (optocoupler, bipolar, 100 mA, short-circuit protection)	IP 20	1	N0532A
	24	/ < 50	10	-20...60	relay (1 changeover contact per channel)	IP 20	1	N0533A
	24	/ < 50	5000	-20...60	2 transistor outputs PNP (100 mA, short-circuit protection)	IP 20	1	N0534A

Scale drawings / drawing no. – CAD download: www.ifm.com

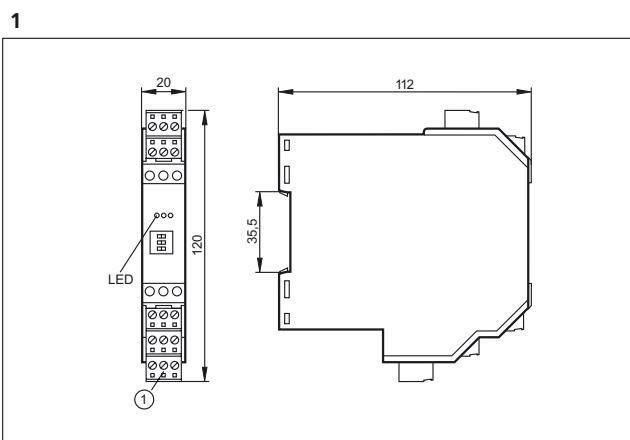

1: Combicon plug with screw terminals (optional)



Keeping things moving



Spindle monitoring: encoder with display in the speed monitor mode.



Sensors for motion control

Sensors for motion control are used for measurements of angles and linear and rotational speed.

Encoders

Encoders convert rotary motion into digital signals. This rotary motion is the result of linear measurements, for example on conveyor belts, or of angle measurements such as those taken by solar tracking systems to optimally align the solar panels towards the sun.

Inclination sensors





Inclination sensors are also used for angle measurement. They are smaller than encoders and easier to install. The core element is a measuring cell for example based on MEMS technology (Micro Electro Mechanical Systems). This measuring method allows evaluation of two axes in one unit. Inclination sensors are therefore a valuable supplement to encoders. They are frequently used in mobile machines (levelling of cranes or fire engines) or in the field of renewable energies.

Speed sensors

Inductive speed sensors with integrated evaluation electronics do not only measure revolutions, but also monitor overspeed and underspeed. Once the sensor has been taught the desired speed, it works completely independently. It relieves the user from the additional burden of programming his PLC: he only needs to connect the sensor, teach the rotational speed and start the system. If the speed drops below the set value or exceeds it, the sensor sets a binary switching output as a warning.

Systems for pulse evaluation

By using the matching evaluation systems, sensor pulses can be detected, evaluated, compared and converted into different output signals. The user can choose between binary, analogue (4...20 mA and 0...10 V) and PWM output signals.

	Encoders	332 - 342
	Speed sensors	344 - 350
	Inclination sensors	352 - 355
	Pulse evaluation systems	356 - 365



- Robust industrial absolute and incremental shaft encoders
- Industrial standard housings
- Solid or hollow-shaft variants
- Cable entry for axial and radial use
- Designs with integrated bus interface

Encoders

As a reliable aid to precise positioning an optical encoder cannot be beaten. Encoders convert rotary or oscillating motion into digital signals. A graduated hardened glass disc firmly attached to the shaft, which may be a solid, protruding shaft, or a hollow shaft supplies a very accurate pulse or position.

Incremental encoders

Incremental encoders generate a precisely defined number of pulses per revolution. They are a measure of the angular or linear distance moved. The coded disc is divided into separate segments which are alternately transparent or opaque. An LED emits a parallel light beam which illuminates all segments of the coded disc. Photo elements receive the modulated light and convert it into two sinusoidal signals. Digitalisation electronics amplify the signals and shape them into square-wave pulse trains which are generated via the line driver in the output. The phase difference between signals A and B, which are phase-shifted by 90 degrees, allows evaluation of the direction of rotation.

Absolute encoders

Absolute encoders provide an absolute numerical value for each angular position. This code value is available immediately after power is applied. This "absolute" value makes a reference procedure like the one required for the incremental encoder unnecessary. Absolute encoders are used wherever angular positions have to be allocated to a certain value and where the detection of the present position is necessary in the event of a power failure.

Multiturn

Absolute encoders divide a mechanical revolution (0 to 360 degrees) into a certain number of measuring steps. The measuring values are repeated after one revolution. The maximum resolution is 8192. Multiturn encoders, however, do not only detect angular positions but also distinguish between multiple revolutions. The amount of information available means the connection of modern absolute encoders is done via a serial bus.

Rugged construction

Shaft encoders are designed to be physically attached to the moving component, so are constructed with robustness in mind. Permissible shaft loads are very high, and internally the electronics are designed to withstand even the inevitable moisture ingress at the shaft.



Linear measurement by means of a counter: Rotary movement is converted into digital signals.

Linear measurement by means of a measuring wheel and an encoder.





System overview	Page
Solid shaft encoders, programmable via IO-Link	334
Hollow shaft encoders, programmable via IO-Link	334 - 335
Encoders with display, programmable via IO-Link or pushbuttons	335
Absolute multiturn encoders (SSI)	335
Absolute singleturn encoders (Profibus)	336
Absolute multiturn encoders (Profibus)	336
Absolute multiturn encoders (ProfiNet)	336
Absolute singleturn-encoders (CANopen)	336 - 337
Absolute multiturn-encoders (CANopen)	337
Fixing accessories for encoders	337
Couplings for encoders	338
Measuring wheels for encoders	339
Connectors for encoders	339 - 340
Scale drawings / drawing no. – CAD download: www.ifm.com	340 - 342

Solid shaft encoders, programmable via IO-Link

Type	Shaft	U _b [V]	Ambient temperature [°C]	Description	Drawing no.	Order no.
M12 connector · 5-pole · Output function HTL, TTL 50 mA						
	6	4.5...30	-40...85	Solid shaft encoder · Magnetic detection system · Connector, radial, can also be used axially	1	RB3100
Cable 2 m · Output function HTL, TTL 50 mA						
	6	4.5...30	-40...80	Solid shaft encoder · Magnetic detection system · Cable, radial, can also be used axially	2	RB3500
M12 connector · 5-pole · Output function HTL, TTL 50 mA						
	6	4.5...30	-40...85	Solid shaft encoder · Synchro-flange · Magnetic detection system · Connector, radial, can also be used axially	3	RU3100
Cable 2 m · Output function HTL, TTL 50 mA						
	6	4.5...30	-40...80	Solid shaft encoder · Synchro-flange · Magnetic detection system · Cable, radial, can also be used axially	4	RU3500
M12 connector · 5-pole · Output function HTL, TTL 50 mA						
	10	4.5...30	-40...85	Solid shaft encoder · Clamping flange · Magnetic detection system · Connector, radial, can also be used axially	5	RV3100
Cable 2 m · Output function HTL, TTL 50 mA						
	10	4.5...30	-40...80	Solid shaft encoder · Clamping flange · Magnetic detection system · Cable, radial, can also be used axially	6	RV3500

Hollow shaft encoders, programmable via IO-Link

Type	Shaft	U _b [V]	Ambient temperature [°C]	Description	Drawing no.	Order no.
M12 connector · 5-pole · Output function HTL, TTL 50 mA						
	6 H7	4.5...30	-40...85	Hollow shaft encoder open to one side · Magnetic detection system · Connector, radial, can also be used axially	7	RA3100
Cable 2 m · Output function HTL, TTL 50 mA						
	6 H7	4.5...30	-40...80	Hollow shaft encoder open to one side · Magnetic detection system · Cable, radial, can also be used axially	8	RA3500

Type	Shaft	U _b [V]	Ambient temperature [°C]	Description	Draw- ing no.	Order no.
------	-------	-----------------------	-----------------------------	-------------	---------------------	--------------

M12 connector · 5-pole · Output function HTL, TTL 50 mA

	12 H7	4.5...30	-40...85	Hollow shaft encoder open to one side · Magnetic detection system · Connector, radial, can also be used axially	9	RO3100
---	-------	----------	----------	---	---	---------------



Cable 2 m · Output function HTL, TTL 50 mA

	12 H7	4.5...30	-40...80	Hollow shaft encoder open to one side · Magnetic detection system · Cable, radial, can also be used axially	10	RO3500
---	-------	----------	----------	---	----	---------------

Encoders with display, programmable via IO-Link or pushbuttons

Type	Shaft	U _b [V]	Ambient temperature [°C]	Description	Draw- ing no.	Order no.
------	-------	-----------------------	-----------------------------	-------------	---------------------	--------------



M12 connector · 8 pole · Output function HTL, TTL 50 mA · Connector groups 16, 17

	6	4.5...30	-40...85	Solid shaft encoder · display · Magnetic detection system · Synchro-flange · Connector, radial, can also be used axially	11	RUP500
	10	4.5...30	-40...85	Solid shaft encoder · display · Magnetic detection system · Clamping flange · Connector, radial, can also be used axially	12	RVP510
	12	4.5...30	-40...85	Hollow shaft encoder open to one side · display · Magnetic detection system · Connector, radial, can also be used axially	13	ROP520

Absolute multiturn encoders (SSI)

Type	Resolution	U _b [V]	f [kHz]	I _{load} [mA]	Shaft [mm]	Ambient temperature [°C]	Cable entry	Draw- ing no.	Order no.
------	------------	-----------------------	------------	---------------------------	---------------	-----------------------------	-------------	---------------------	--------------

Cable 2 m · Output function SSI data interface

	4096	4.5...30	–	–	6	-40...85	axial	14	RM8001
	4096	4.5...30	–	–	10	-40...85	axial	15	RM8002
	4096	4.5...30	–	–	12	-40...85	axial	16	RM8003

Absolute singleturn encoders (Profibus)

Type	Resolution	U _b [V]	f [kHz]	I _{load} [mA]	Shaft [mm]	Ambient temperature [°C]	Cable entry	Drawing no.	Order no.
------	------------	-----------------------	------------	---------------------------	---------------	-----------------------------	-------------	-------------	-----------



Terminals · Output function Profibus data interface

	13 bits	10...30	–	–	10	-40...85	–	17	RM3001
---	---------	---------	---	---	----	----------	---	----	--------

Absolute multiturn encoders (Profibus)

Type	Resolution	U _b [V]	f [kHz]	I _{load} [mA]	Shaft [mm]	Ambient temperature [°C]	Cable entry	Drawing no.	Order no.
------	------------	-----------------------	------------	---------------------------	---------------	-----------------------------	-------------	-------------	-----------



Terminals · Output function Profibus data interface

	25 bits	10...30	–	–	6	-40...85	–	18	RM3006
	25 bits	10...30	–	–	10	-40...85	–	19	RM3007
	25 bits	10...30	–	–	12	-40...85	–	20	RM3008

Absolute multiturn encoders (ProfiNet)

Type	Resolution	U _b [V]	f [kHz]	I _{load} [mA]	Shaft [mm]	Ambient temperature [°C]	Cable entry	Drawing no.	Order no.
------	------------	-----------------------	------------	---------------------------	---------------	-----------------------------	-------------	-------------	-----------

M12 connector · Output function ProfiNet IO data interface · Connector groups 8, 10, 11, 18, 20, 120, 124, 126, 128, 130, 157, 158

	25 bits	10...30	–	–	10	-40...85	–	21	RM3011
	25 bits	10...30	–	–	12	-40...85	–	22	RM3010

Absolute singleturn-encoders (CANopen)

Type	Resolution	U _b [V]	f [kHz]	I _{load} [mA]	Shaft [mm]	Ambient temperature [°C]	Cable entry	Drawing no.	Order no.
------	------------	-----------------------	------------	---------------------------	---------------	-----------------------------	-------------	-------------	-----------

Terminals · Output function CANopen interface

	13 bits	10...30	–	–	6	-40...85	–	23	RN7011
---	---------	---------	---	---	---	----------	---	----	--------

Type	Resolution	U _b [V]	f [kHz]	I _{load} [mA]	Shaft [mm]	Ambient temperature [°C]	Cable entry	Draw- ing no.	Order no.
------	------------	-----------------------	------------	---------------------------	---------------	--------------------------------	----------------	---------------------	--------------

Terminals · Output function CANopen interface

	13 bits	10...30	–	–	10	-40...85	–	17	RN7012
---	---------	---------	---	---	----	----------	---	----	--------

Absolute multiturn-encoders (CANopen)

Type	Resolution	U _b [V]	f [kHz]	I _{load} [mA]	Shaft [mm]	Ambient temperature [°C]	Cable entry	Draw- ing no.	Order no.
------	------------	-----------------------	------------	---------------------------	---------------	--------------------------------	----------------	---------------------	--------------

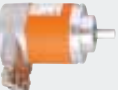

Terminals · Output function CANopen interface

	25 bits	10...30	–	–	6	-40...85	–	18	RM7011
	25 bits	10...30	–	–	10	-40...85	–	19	RM7012









Fixing accessories for encoders

Type	Description	Order no.
	Resilient base for angle flanges · Housing materials: aluminium black anodised	E60036
	Angle bracket · for encoders · for type RB, RC, RM, RN, RU · Housing materials: aluminium black anodised	E60033
	Angle bracket · for encoders · for type RM, RMU, RN, RU · Housing materials: aluminium black anodised	E60034
	Angle bracket · for encoders · for type RMV, RV · Housing materials: aluminium black anodised	E60035
	Angle bracket · for encoders · for type RM · Housing materials: aluminium black anodised	E60302
	Fastening clamp · for solid shaft encoders · Housing materials: steel	E60041

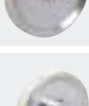

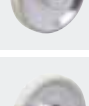

Couplings for encoders

Type	Description	Order no.
	Flexible coupling with clamp connection [KV] · Ø 4 mm / Ø 6 mm · Housing materials: aluminium	E60119
	Flexible coupling with clamp connection [KV] · Ø 6 mm / Ø 6 mm · Housing materials: aluminium	E60064
	Flexible coupling with clamp connection [KV] · Ø 6 mm / Ø 6 mm · Housing materials: aluminium	E60065
	Flexible coupling with clamp connection [KV] · Ø 6 mm / Ø 8 mm · Housing materials: aluminium	E60120
	Flexible coupling with clamp connection [KV] · Ø 6 mm / Ø 10 mm · Housing materials: aluminium	E60066
	Flexible coupling with clamp connection [KV] · Ø 10 mm / Ø 10 mm · Housing materials: aluminium	E60067
	Flexible coupling with adjusting screw connection [SV] · Ø 4 mm / Ø 6 mm · Housing materials: aluminium	E60062
	Flexible coupling with adjusting screw connection [SV] · Ø 6 mm / Ø 6 mm · Housing materials: aluminium	E60063
	Flexible coupling with adjusting screw connection [SV] · Ø 6 mm / Ø 8 mm · Housing materials: aluminium	E60027
	Flexible coupling with adjusting screw connection [SV] · Ø 6 mm / Ø 10 mm · Housing materials: aluminium	E60028
	Flexible coupling with adjusting screw connection [SV] · Ø 10 mm / Ø 10 mm · Housing materials: aluminium	E60022
	Spring disc coupling electrically isolating · Ø 6 mm / Ø 6 mm · Housing materials: diecast zinc / PA	E60121
	Spring disc coupling electrically isolating · Ø 6 mm / Ø 10 mm · Housing materials: diecast zinc / PA	E60117
	Spring disc coupling electrically isolating · Ø 10 mm / Ø 10 mm · Housing materials: diecast zinc / PA	E60118
	Plastic beam coupling with stainless steel hub · Ø 10 mm / Ø 10 mm · Housing materials: PA 6.6 / stainless steel 316L / 1.4404	E60193

Measuring wheels for encoders

Type	Description	Order no.
	Measuring wheel · Ø 159.15 mm / Ø 10 mm · cross-knurl · Housing materials: wheel: aluminium	E60098
	Measuring wheel · Ø 63.6 mm / Ø 6 mm · aluminium · Housing materials: wheel: aluminium	E60006
	Measuring wheel · Ø 63.6 mm / Ø 10 mm · aluminium · Housing materials: wheel: aluminium	E60095
	Measuring wheel · Ø 159.16 mm / Ø 10 mm · rubber · Housing materials: wheel: aluminium / tread: PU	E60076
	Measuring wheel · Ø 159.15 mm / Ø 10 mm · smooth plastic · Housing materials: wheel: Hytrel TPE-E	E60110
	Measuring wheel · Ø 63.66 ±0.1 mm / Ø 6 mm · smooth plastic · Housing materials: wheel: Hytrel TPE-E	E60111
	Measuring wheel · Ø 63.66 ±0.1 mm / Ø 10 mm · smooth plastic · Housing materials: wheel: Hytrel TPE-E	E60112
	Measuring wheel · Ø 63.66 ±0.1 mm / Ø 6 mm · grooved plastic · Housing materials: wheel: aluminium	E60137
	Measuring wheel · Ø 63.66 ±0.1 mm / Ø 10 mm · grooved plastic · Housing materials: wheel: Hytrel TPE-E	E60138

Connectors for encoders

Type	Description	Order no.
	Socket · angled · Free from silicone · Free from halogen · Gold-plated contacts · For applications in particularly harsh environments · M12 connector · 2 m · Housing materials: housing: TPU orange / sealing: FKM	EVM039
	Socket · angled · Free from silicone · Free from halogen · Gold-plated contacts · M12 connector with integrated CAN terminating resistor (120 ohm) · 5 m · Housing materials: housing: TPU black / sealing: FKM	EVC492
	Socket · straight · Free from silicone · Free from halogen · Gold-plated contacts · For applications in particularly harsh environments · M12 connector · 2 m · Housing materials: housing: TPU orange / sealing: FKM	EVM036
	Socket · straight · M12 connector · 2 m · Housing materials: TPU	E12402

Type	Description	Order no.
------	-------------	-----------



Jumper · straight / straight · Free from halogen · 0.3 m · Housing materials: PUR

E12432

Scale drawings / drawing no. – CAD download: www.ifm.com

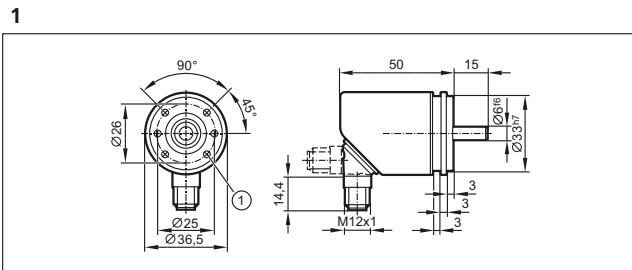

1: M3 x 0.5 6 mm deep

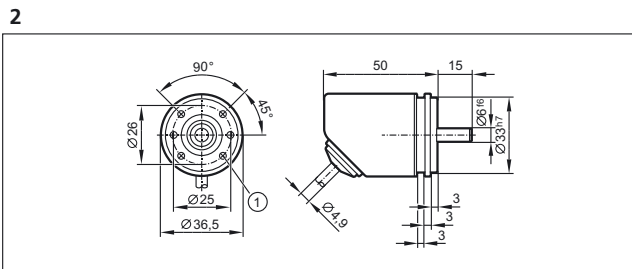

1: M3 x 0.5 6 mm deep

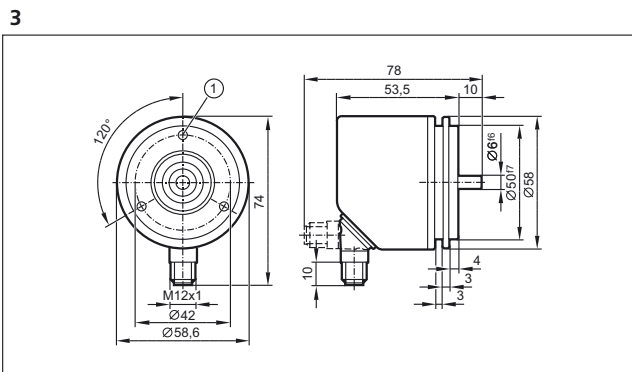

1: M4 x 0.7 6 mm deep

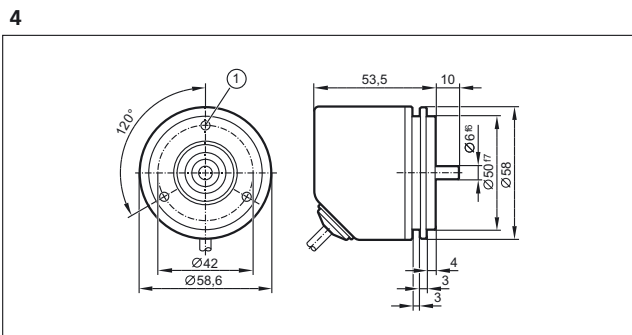

1: M4 x 0.7 6 mm deep

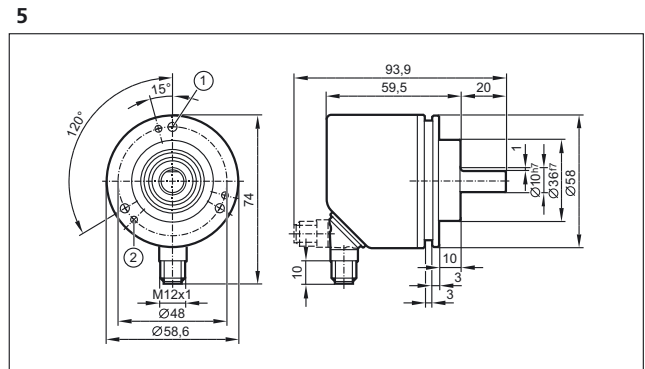

1: M4 x 0.7 6 mm deep, 2: M3 x 0.5 6 mm deep

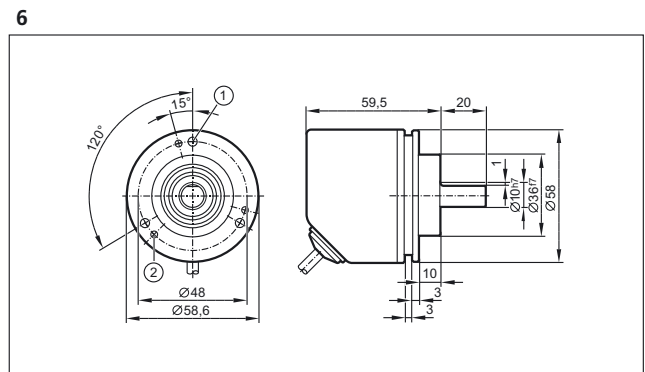

1: M4 x 0.7 6 mm deep, 2: M3 x 0.5 6 mm deep

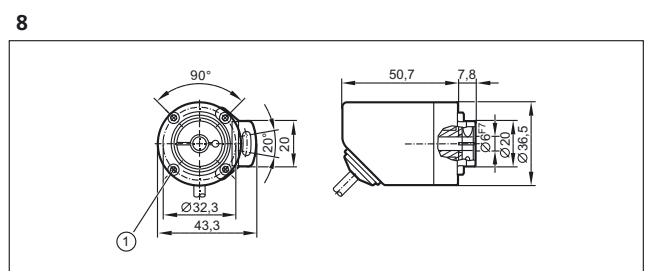
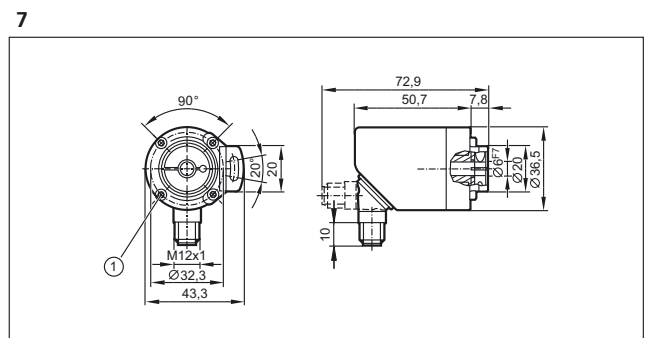

Scale drawings / drawing no. – CAD download: www.ifm.com

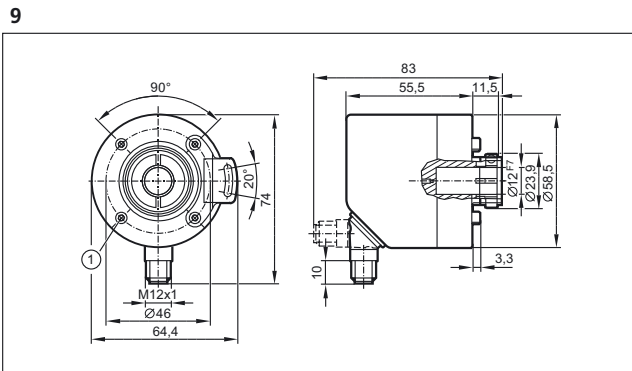

1: M3 x 0.5 6 mm deep

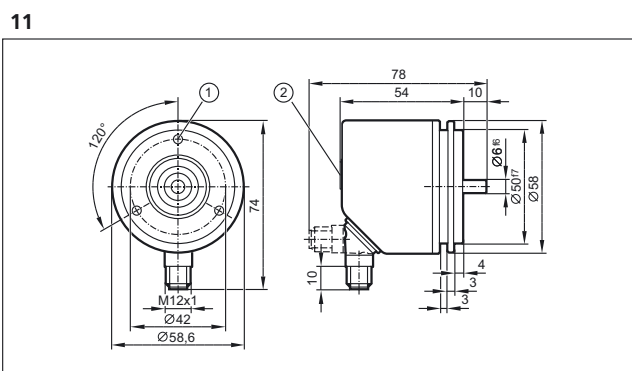
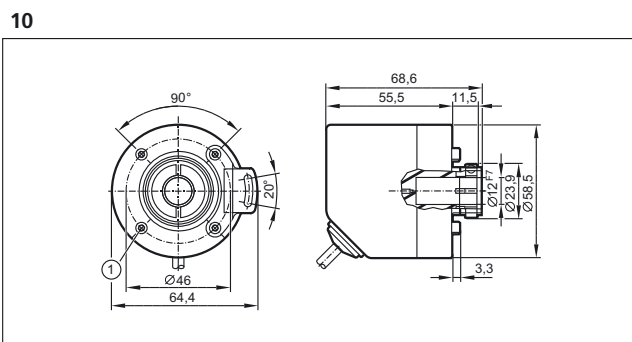

1: M4 x 0.7 6 mm deep, 2: display

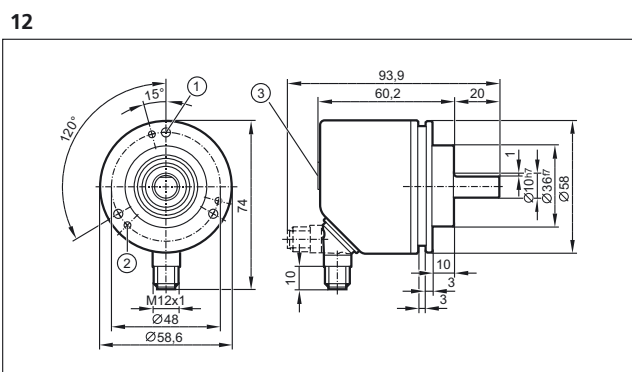

1: M4 x 0.7 6 mm deep, 2: M3 x 0.5 6 mm deep, 3: display

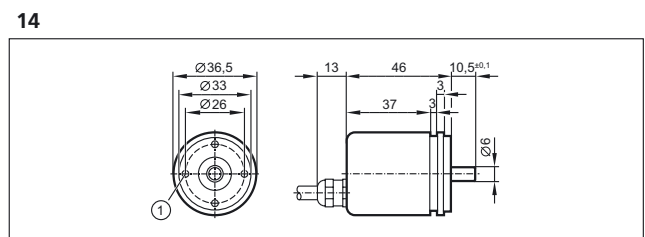
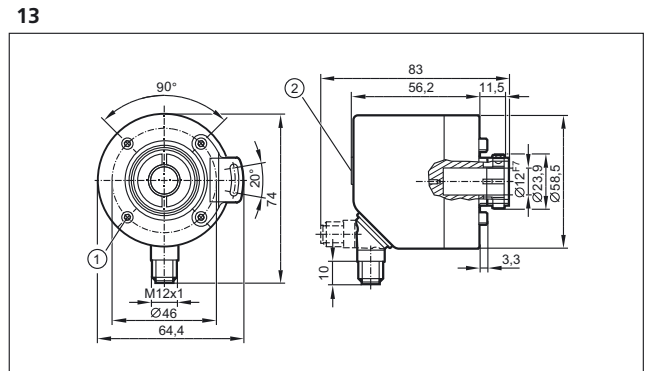

M3 6 mm deep

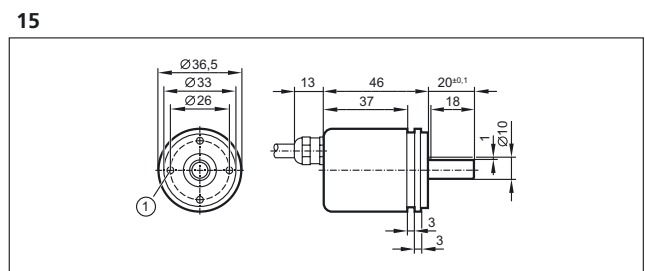

M3 6 mm deep

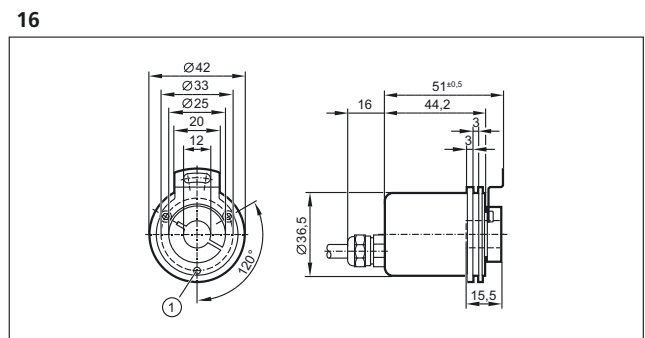

1: M3 x 6

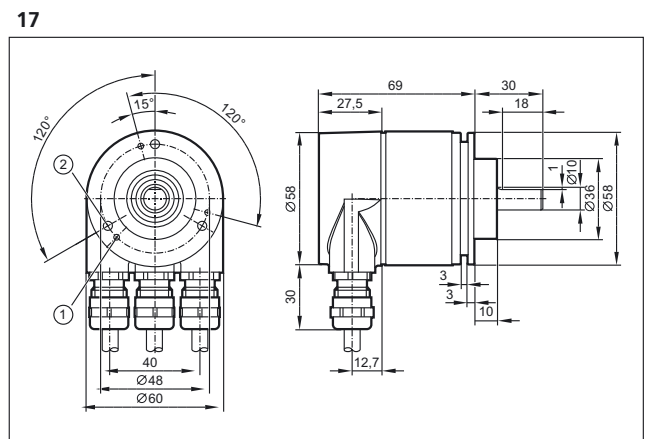

1: M3 6 mm deep, 2: M4 6 mm deep

Scale drawings / drawing no. – CAD download: www.ifm.com

18

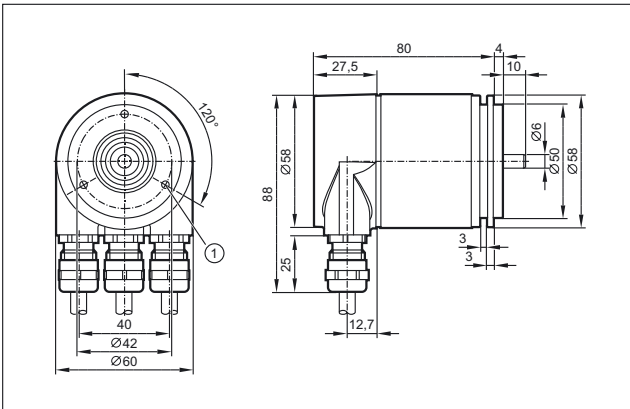

21

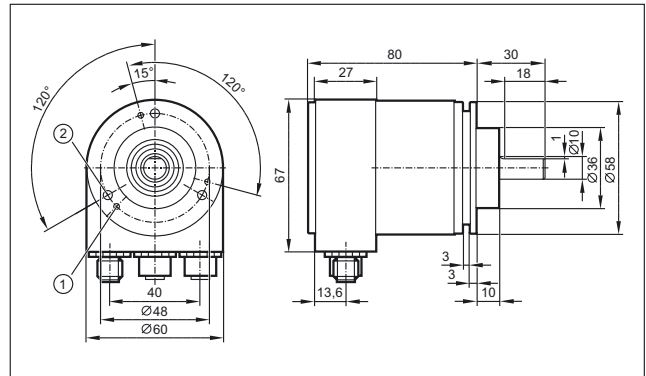

1: M3 6 mm deep, 2: M4 6 mm deep

19

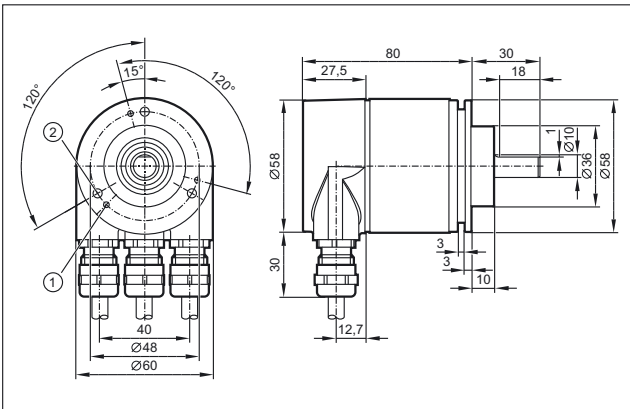

1: M3 6 mm deep, 2: M4 6 mm deep

22

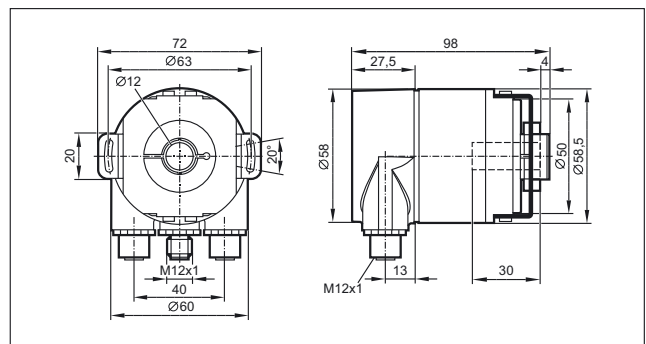

23

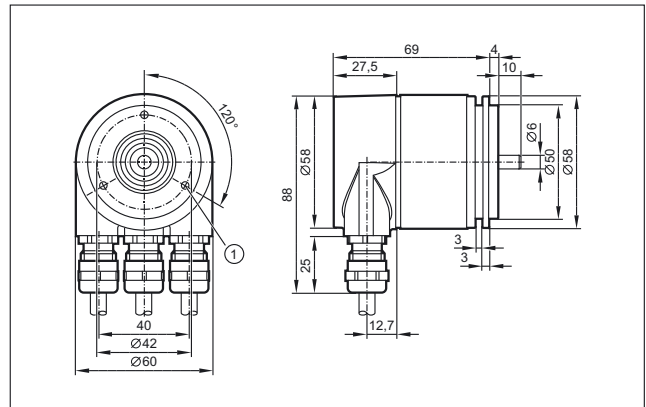

20

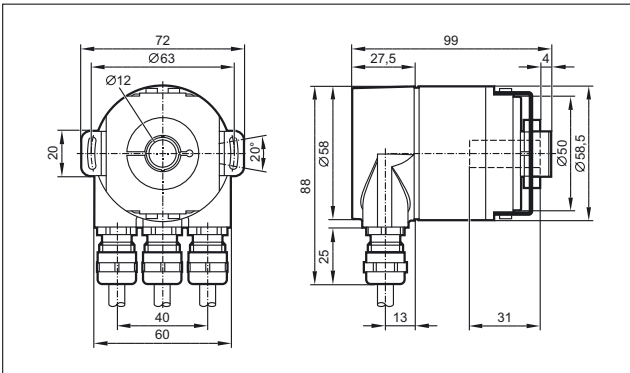





- 2 in 1: speed sensor and evaluation in one compact housing
- Space-saving design
- Easy to fit
- Easy parameter setting by potentiometer or pushbutton

Inductive sensor with integrated speed evaluation

In many industrial applications drives need to be monitored for rotational speed or standstill. A typical application in building automation is V-belt monitoring on fans. In conveying, standstill monitoring is used to detect belt break on conveyors. A similar principle is applied in agricultural engineering to monitor elevator drives or detect blockage of screw conveyors. Application examples can also be found in the textile industry. Here the compact speed monitor signals thread break on sewing machines. The compact DI series speed monitor offers a specially low-cost and reliable solution. In principle it is an inductive sensor with integrated speed evaluation. The advantage: the condition information of the drive is directly transferred to the control system. The nominal speed is easily set by potentiometer or pushbutton.

Versions

ifm offers the right unit for each application. The user can choose between M18 and M30 types with either M12 connector or cable. There are 2-wire and 3-wire units with either NC or NO function. For use in hazardous areas ifm offers speed monitors with ATEX 3D approval. The high switching frequency of 15,000 Hz as well as the extended temperature range of -32...125 °C make ifm's new magnetic speed sensors ideal for the detection of speed and direction of rotation on drives, axes and shafts. The detection of both direction of rotation and rotational speed is integrated into one housing.

The sensors have fully electronic magnetic measuring cells, so that they function reliably without contact even in case of heavy soiling. They are "magnetically biased" with an integrated permanent magnet. The ferromagnetic teeth on a toothed wheel alter the existing magnetic field so that a corresponding switching signal can be generated.

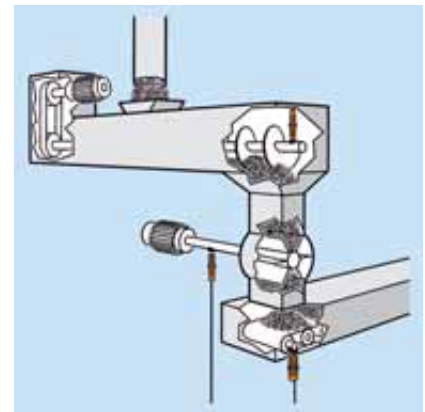

In conveying, compact speed monitors monitor drive shafts and conveyor belts.

Different housing lengths and connections can be combined.



System overview	Page
Speed monitor with integrated sensor	346
Speed monitors with integrated sensor, ATEX category 3D	347
Speed sensors with magnetic measuring principle	347 - 348
Accessories	348
Wiring diagrams	349
Scale drawings / drawing no. – CAD download: www.ifm.com	349 - 350

Speed monitor with integrated sensor

Type	Dimensions [mm]	Sensing range [mm]	Electrical design	U _b [V]	Setting range [puls. / min.]	Start-up delay [s]	Drawing no.	Order no.
------	--------------------	-----------------------	-------------------	-----------------------	---------------------------------	-----------------------	-------------	-----------

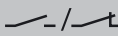
Output function  · Wiring diagram no. 1 · Connector groups 8, 10, 11, 18, 20, 120, 124, 126, 128, 130, 157, 158

	M18 / L = 68	12 nf	DC PNP	10...36 DC	3...6000	0...15	1	DI6001
---	--------------	-------	--------	------------	----------	--------	---	--------

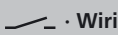
Output function  · Wiring diagram no. 2

	M30 / L = 81	10 f	AC/DC	20...250 AC/DC	5...300	12	2	DI0001*
	M30 / L = 81	10 f	AC/DC	20...250 AC/DC	50...3000	12	2	DI0002*
	M30 / L = 81	10 f	AC/DC	20...250 AC/DC	5...300	< 0.5	2	DI0004*

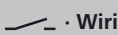
Output function  · Wiring diagram no. 3

	M30 / L = 81	10 f	DC PNP	10...36 DC	5...300	15	2	DI5001
	M30 / L = 81	10 f	DC PNP	10...36 DC	30...3000	15	2	DI5003
	M30 / L = 81	10 f	DC PNP	10...36 DC	30...3000	0	2	DI5011

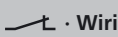
Output function  · Wiring diagram no. 4

	M30 / L = 81	10 f	DC PNP	10...36 DC	5...300	15	2	DI5005
---	--------------	------	--------	------------	---------	----	---	--------

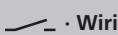
Output function  · Wiring diagram no. 5

	M30 / L = 81	10 f	DC PNP	10...36 DC	5...300	15	3	DI5004
	M30 / L = 81	10 f	DC PNP	10...36 DC	5...300	5	3	DI5007

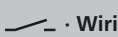
Output function  · Wiring diagram no. 6 · Connector groups 8, 10, 11, 18, 20, 120, 124, 126, 128, 130, 157, 158

	M30 / L = 82	10 f	DC PNP	10...36 DC	5...300	15	4	DI5009
---	--------------	------	--------	------------	---------	----	---	--------

f = flush / nf = non flush

* Note for AC and AC/DC units

Miniature fuse to IEC60127-2 sheet 1, ≤ 2 A (fast acting) Recommendation: check the unit for reliable function after a short circuit.

Speed monitors with integrated sensor, ATEX category 3D

Type	Dimensions [mm]	Sensing range [mm]	Electrical design	U _b [V]	Setting range [puls. / min.]	Start-up delay [s]	Drawing no.	Order no.
------	--------------------	-----------------------	-------------------	-----------------------	---------------------------------	-----------------------	-------------	-----------

Output function  · Wiring diagram no. 2



	M30 / L = 81	10 f	AC/DC	20...250 AC/DC	5...300	12	5	DI003A*
	M30 / L = 81	10 f	AC/DC	20...250 AC/DC	50...3000	12	5	DI004A*

Output function  · Wiring diagram no. 3

	M30 / L = 81	10 f	DC PNP	10...36 DC	5...300	15	5	DI504A
---	--------------	------	--------	------------	---------	----	---	--------

Output function  · Wiring diagram no. 6 · Connector group --

	M30 / L = 82	10 f	DC PNP	10...36 DC	5...300	15	6	DI505A
	M30 / L = 82	10 f	DC PNP	10...36 DC	5...300	5	6	DI506A

Output function  /  · Wiring diagram no. 1 · Connector group --

	M18 / L = 68	8 nf	DC PNP	10...36 DC	3...6000	0...15	7	DI602A
---	--------------	------	--------	------------	----------	--------	---	--------

f = flush / nf = non flush



* Note for AC and AC/DC units

Miniature fuse to IEC60127-2 sheet 1, ≤ 2 A (fast acting) Recommendation: check the unit for reliable function after a short circuit.

Speed sensors with magnetic measuring principle

Type	Dimensions [mm]	Sensing range [mm]	Electrical design	U _b [V]	Connection	Ambient temperature sensor [°C]	Drawing no.	Order no.
------	--------------------	-----------------------	-------------------	-----------------------	------------	------------------------------------	-------------	-----------

Wiring diagram no. 7

	special design / L = 49.5	1.7	DC NPN	15	PUR cable	-32...140	8	MX5015
	special design / L = 50	1.7	DC NPN	15	PUR cable	-32...140	9	MX5017



Sensors for motion control

Type	Dimensions [mm]	Sensing range [mm]	Electrical design	U _b [V]	Connection	Ambient temperature sensor [°C]	Draw- ing no.	Order no.
------	--------------------	-----------------------	-------------------	-----------------------	------------	------------------------------------	------------------	-----------









Output function · Wiring diagram no. 8

	special design / L = 60	1.7	DC PNP	10...30 DC	PUR cable	-32...85	10	MX5050
---	----------------------------	-----	--------	------------	-----------	----------	----	---------------

Wiring diagram no. 9

	special design / L = 61	1.7	DC NPN	7...30	AMP Junior Timer connector (282 1921)	-32...140	11	MX5004
	special design / L = 70	1.7	DC NPN	7...30	AMP Junior Timer connector (282 1921)	-32...140	12	MX5000

Accessories

Type	Description	Order no.
	Angle bracket · for type M18 · Housing materials: stainless steel	E10736
	Angle bracket · for type M30 · Housing materials: stainless steel	E10737
	Mounting clamp · Ø 20 mm - Ø 18 mm · with reducing bush · for type M18 · Housing materials: PBT	E10076
	Mounting clamp · Ø 34 mm - Ø 30 mm · with reducing bush · for type M30 · Housing materials: PBT	E10077
	Target wheel · Plastic disk with 8 screws as "target" · Centered drill holes	E89010
	Target for pulse pickups · Strap dimensions 7 x 145 mm	E89013
	Cable plug · straight · 10 m	E60303
	Amplifier · 1-channel · selectable for pnp and npn switching sensors · Output 24 V DC / 300 mA · short-circuit and overload protection · Housing materials: plastics: PC GF20	DN0210

Wiring diagrams

Core colours

- BN brown
- BU blue
- BK black

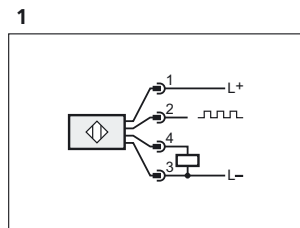

2: pulse output (the pulse sequence corresponds to the damping frequency),
4: switching output (adjustable)

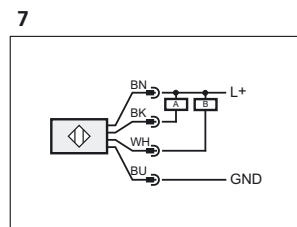
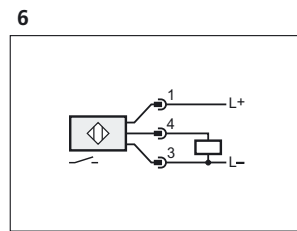
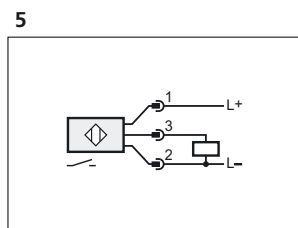
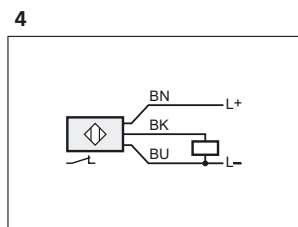
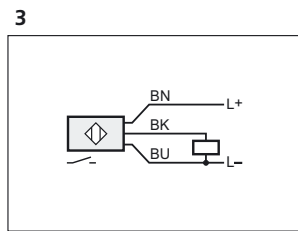
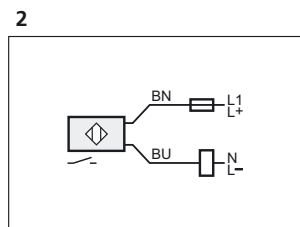

A: Pulse output, B: pulse output (the pulse sequence corresponds to the damping frequency)

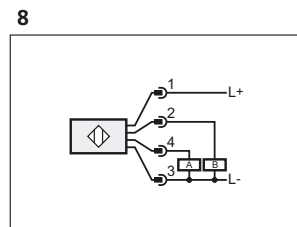

A: Pulse output, B: pulse output (the pulse sequence corresponds to the damping frequency)

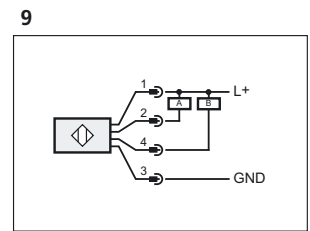

A: Pulse output, B: pulse output (the pulse sequence corresponds to the damping frequency)

Scale drawings / drawing no. – CAD download: www.ifm.com

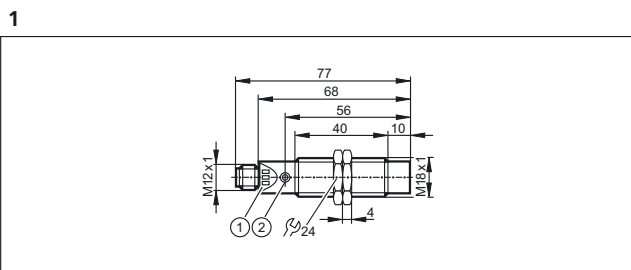

1: 3 LED, 2: setting pushbutton

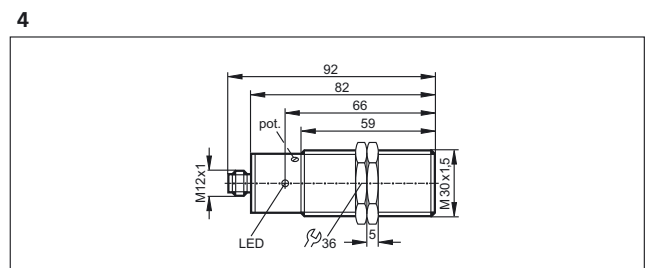
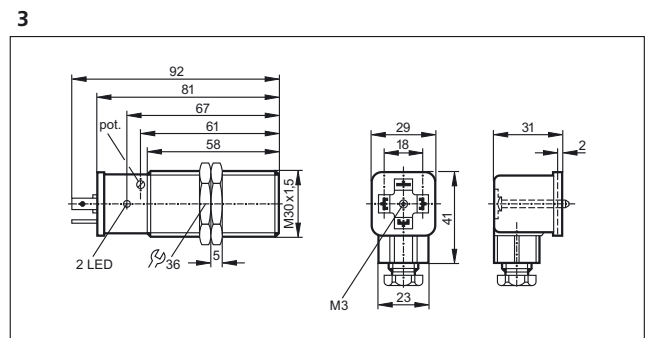
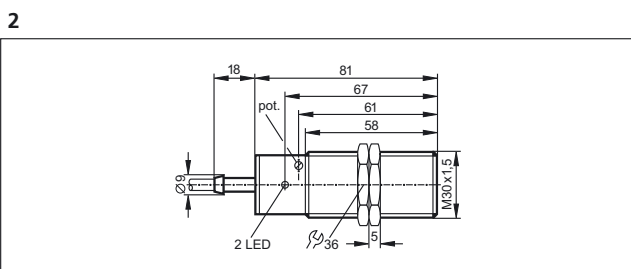

Scale drawings / drawing no. – CAD download: www.ifm.com

5

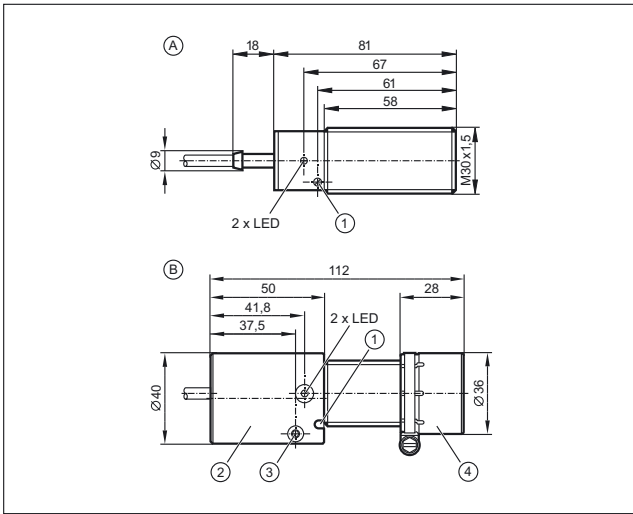

A: Sensor, B: sensor with impact protection housing,
1: potentiometer, 2: impact protection housing for the cable,
3: clamping screw, 4: impact protection housing for the sensor

6

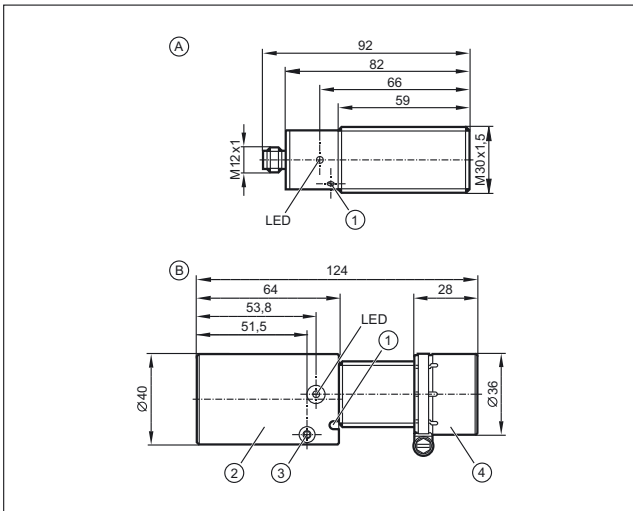

A: Sensor, B: sensor with impact protection housing,
1: potentiometer, 2: impact protection housing for the connector,
3: clamping screw, 4: impact protection housing for the sensor

7

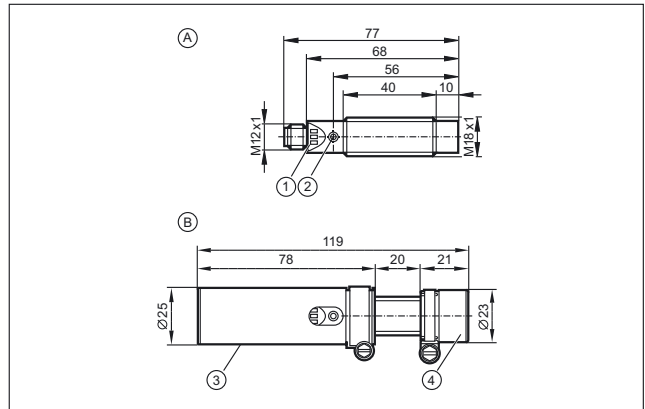

A: Sensor, B: sensor with impact protection housing, 1: 3 LED,
2: setting pushbutton, 3: impact protection housing for the connector,
4: impact protection housing for the sensor

8

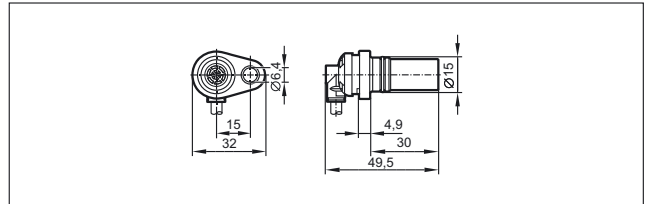

9

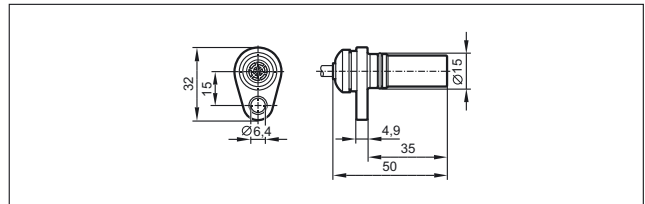

10

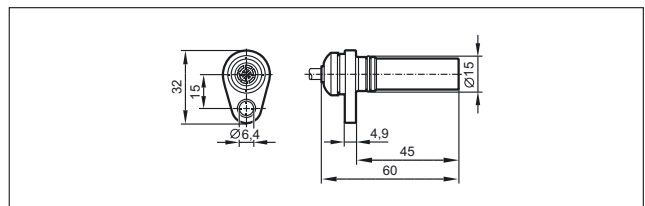

11

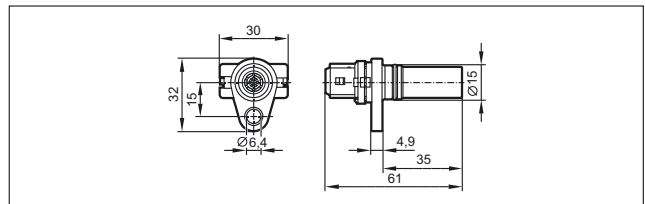

12

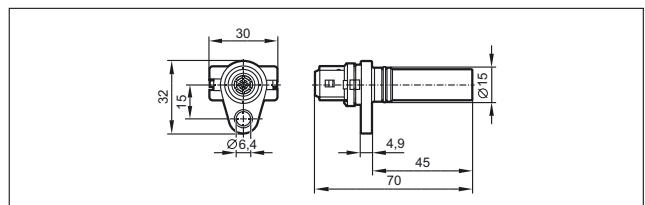





- Compact and robust design
- Wide angle range and high accuracy
- Sensor types for signal output via CANbus, IO-Link as digital or analogue signal
- High protection rating IP 65 to IP 69K
- CAN and IO-Link sensors are configurable

Inclination detection in general

Electronic controllers and sensors are fundamental to the automation of vehicles and mobile machines. Often the horizontal alignment of machines or machine parts is an important requirement for reliable operation. Typical applications are cranes, access platforms or outriggers.

ifm offers a variety of different inclination sensor and tilt switch models.

They basically differ with regard to the signal output, the number of measurement axes, the measuring range and the connection type. The micromechanics of the integrated capacitive measuring cell in the sensors responds to gravitational acceleration. That means that the inclination moves the test mass and changes its position.

This test mass is situated between two capacitor plates for capacitive detection.

This is a proven method that is especially applied in case of high demands on accuracy and if the sensors are exposed to external interference such as temperature, vibration and shocks. Depending on the sensor type, signal output is analogue, digital or takes place via CANbus or IO-Link.











If only a switch point is to be detected, the mercury-free tilt sensor EC 2061 is used. Due to its design it has the same good switching characteristics as a conventional mercury switch. Due to the harmless alcohol filling of the switching element, it has considerable ecological advantages in case of damage or disposal.



<i>System overview</i>	<i>Page</i>
Inclination sensors	354
Scale drawings / drawing no. – CAD download: www.ifm.com	354 - 355



Inclination sensors

Type	Description	Draw- ing no.	Order no.
	Inclination sensor · 0...360° / ± 180° · CANopen interface · Self-test function · Heartbeat · Emergency messages available · housing: diecast zinc nickel-plated	1	JN2100
	Inclination sensor · ± 180° · IO-Link interface · Analogue / binary outputs · Self-test function · housing: diecast zinc nickel-plated	2	JN2200
	Inclination sensor · 0...360° / ± 180° · SAE J1939 interface · Self-test function · Diagnostic Trouble Code (DTC) available · housing: diecast zinc nickel-plated	1	JN2300
	Inclination sensor · ± 45° · CANopen interface · Self-test function · Heartbeat · Emergency messages available · housing: diecast zinc nickel-plated	1	JN2101
	Inclination sensor · ± 45° · IO-Link interface · Analogue / binary outputs · Self-test function · housing: diecast zinc nickel-plated	2	JN2201
	Inclination sensor · ± 45° · SAE J1939 interface · Self-test function · Diagnostic Trouble Code (DTC) available · housing: diecast zinc nickel-plated	1	JN2301
	Inclination sensor · ± 90° · 15...30 V DC · Output 0...10 V · Cable	3	EC2019
	Inclination sensor · ± 90° · Input 8...30 V DC · Output 0.5...4.5 V · Cable	3	EC2045
	Inclination sensor · ± 20° · Analogue output · 4...20 mA	3	EC2060
	Inclination sensor · ± 90° · Analogue output · 4...20 mA	3	EC2082
	Tilt sensor · free from mercury · semi-conductor output · 10...30 V DC · Cable	4	EC2061

Scale drawings / drawing no. – CAD download: www.ifm.com

1

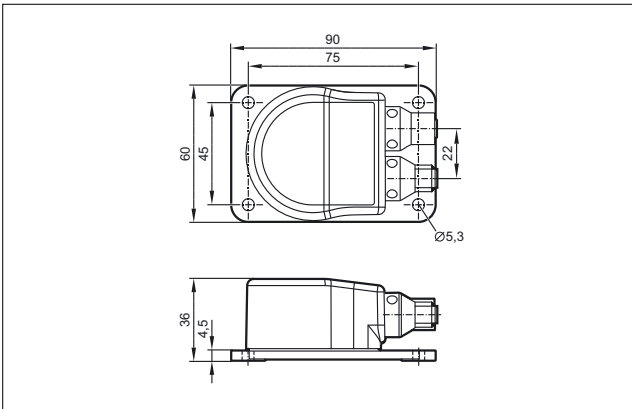

2

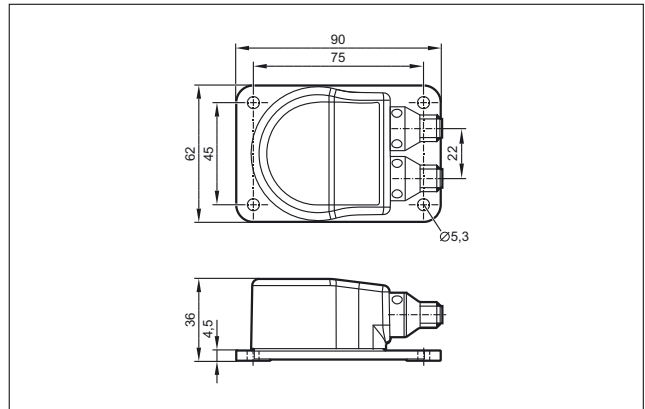

3

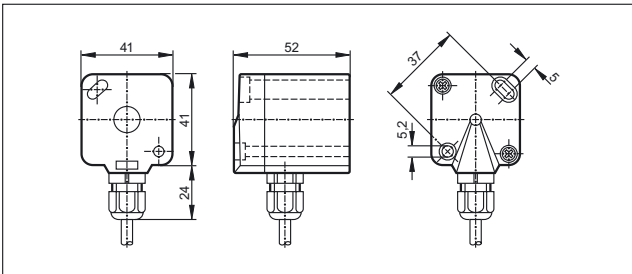

4

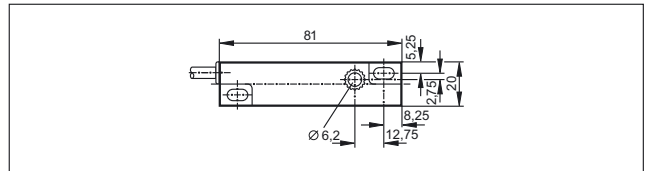



- Easy adjustment and parameter setting
- Primary voltage 24V DC or 110 / 230V AC, wide-range input
- Programmable switching characteristics
- Standstill, overspeed, direction, slip and frequency conversion, counter
- Switching relays and transistor outputs, scalable analogue output

Evaluation systems

Although PLC applications in industrial automation are becoming more and more versatile there are still numerous processes in practice which require decentralised monitoring.

For this ifm offers a number of pulse evaluation systems. Shown here is the versatile system for monitoring overspeed or underspeed using sophisticated microprocessor systems which are nonetheless easy to use. Also included is the monitor designed for very safe indication that moving parts have stopped.

In addition to the units for rail mounting there are also self-contained compact designs in metal M18 and M30 housings, where the pick-up sensor and evaluation are all in one device.

Overall ifm offers the following evaluation systems:

- Speed monitors
- Standstill monitors
- Slip / synchronisation monitors
- Direction monitors
- Frequency-to-current converters
- Threshold relays
- Displays with frequency and analogue input
- Counters
- Level monitoring relays / level control relays



Pulse evaluation systems are used for decentralised monitoring of drives.

Machine cycles must also be monitored in conveying.



System overview	Page
Universal speed monitors	358
Universal speed monitors with sensor wire monitoring	358
Dual speed monitors	358
Dual speed monitors with sensor wire monitoring	358
Standard speed monitors / standstill monitor	359
Level monitoring relays	359
Level control relays	359
Slip monitors	359
Slip monitors with sensor wire monitoring	360
Slip / synchronous monitors	360
Slip / synchronous monitors with sensor wire monitoring	360
Combined direction and speed monitors	360
Frequency-to-current converters	361
Safety standstill monitors, SIL 3, PL e	361
Safety speed monitor, SIL 3, PL e	361
Multifunctional displays for digital signals / frequency input	362
Universal counters	362
2-channel threshold relay for analogue standard signals	362
Multifunctional displays for analogue standard signals	362 - 363
Timer relays with switch-on / switch-off delay	363
Accessories pulse divider / pulse stretcher	363
Accessories	363 - 364
Scale drawings / drawing no. – CAD download: www.ifm.com	364 - 365

Universal speed monitors

Type	U _b [V]	In-puts	Input function	Setting range [puls. / min.]	Setting range [Hz]	Out-puts analogue	Out-puts relays	Out-puts transist.	Draw-ing no.	Order no.
------	-----------------------	---------	----------------	---------------------------------	-----------------------	-------------------	-----------------	--------------------	--------------	-----------

FR-1 · 2 switch points for monitoring overspeed/underspeed and acceptable range



110...240 AC (50...60 Hz) / 27 DC (typ. 24 DC)	1	PNP / NPN / Namur	1...60000	0.1...1000	1	2	2	1	DD2503
---	---	-------------------	-----------	------------	---	---	---	---	--------

Universal speed monitors with sensor wire monitoring

Type	U _b [V]	In-puts	Input function	Setting range [puls. / min.]	Setting range [Hz]	Out-puts analogue	Out-puts relays	Out-puts transist.	Draw-ing no.	Order no.
------	-----------------------	---------	----------------	---------------------------------	-----------------------	-------------------	-----------------	--------------------	--------------	-----------

FR-1N · 2 switch points for monitoring overspeed/underspeed and acceptable range



110...240 AC (50...60 Hz) / 27 DC (typ. 24 DC)	1	Namur 8.2 V	1...60000	0.1...1000	1	2	4	1	DD2603
---	---	-------------	-----------	------------	---	---	---	---	--------

Dual speed monitors

Type	U _b [V]	In-puts	Input function	Setting range [puls. / min.]	Setting range [Hz]	Out-puts analogue	Out-puts relays	Out-puts transist.	Draw-ing no.	Order no.
------	-----------------------	---------	----------------	---------------------------------	-----------------------	-------------------	-----------------	--------------------	--------------	-----------

FR-2 · 1 switch point each for monitoring overspeed/underspeed and acceptable range



110...240 AC (50...60 Hz) / 27 DC (typ. 24 DC)	2	PNP / NPN / Namur	1...60000	0.1...1000	–	2	2	1	DD2505
---	---	-------------------	-----------	------------	---	---	---	---	--------

Dual speed monitors with sensor wire monitoring

Type	U _b [V]	In-puts	Input function	Setting range [puls. / min.]	Setting range [Hz]	Out-puts analogue	Out-puts relays	Out-puts transist.	Draw-ing no.	Order no.
------	-----------------------	---------	----------------	---------------------------------	-----------------------	-------------------	-----------------	--------------------	--------------	-----------

FR-2N · 1 switch point each for monitoring overspeed/underspeed and acceptable range



110...240 AC (50...60 Hz) / 27 DC (typ. 24 DC)	2	Namur 8.2 V	1...60000	0.1...1000	–	2	4	1	DD2605
---	---	-------------	-----------	------------	---	---	---	---	--------

Standard speed monitors / standstill monitor

Type	U _b [V]	In-puts	Input function	Setting range [puls. / min.]	Setting range [Hz]	Out-puts analogue	Out-puts relays	Out-puts transist.	Draw-ing no.	Order no.
------	-----------------------	---------	----------------	---------------------------------	-----------------------	-------------------	-----------------	--------------------	--------------	-----------

D200 · evaluation of pulse sequences with regard to overspeed and underspeed; rotational speed monitoring

	110...240 AC / 27 (24) DC	1	PNP	0.1...10 / 10...1000	–	–	1	–	2	DD0203
	110...240 AC / 27 (24) DC	1	PNP	0.2...20 / 20...2000	–	–	1	–	2	DD0296

Level monitoring relays

Type	U _b [V]	In-puts	Input function	Setting range [puls. / min.]	Setting range [Hz]	Out-puts analogue	Out-puts relays	Out-puts transist.	Draw-ing no.	Order no.
------	-----------------------	---------	----------------	---------------------------------	-----------------------	-------------------	-----------------	--------------------	--------------	-----------

L200 · protection of a tank against overflow or running dry

	110...240 AC / 27 (24) DC	1	PNP	–	–	–	1	–	3	DL0201
--	---------------------------	---	-----	---	---	---	---	---	---	--------

Level control relays

Type	U _b [V]	In-puts	Input function	Setting range [puls. / min.]	Setting range [Hz]	Out-puts analogue	Out-puts relays	Out-puts transist.	Draw-ing no.	Order no.
------	-----------------------	---------	----------------	---------------------------------	-----------------------	-------------------	-----------------	--------------------	--------------	-----------

L200 · two point level control

	110...240 AC / 27 (24) DC	1	PNP	–	–	–	1	–	4	DL0203
---	---------------------------	---	-----	---	---	---	---	---	---	--------

Slip monitors

Type	U _b [V]	In-puts	Input function	Setting range	Out-puts relays	Out-puts transist.	Draw-ing no.	Order no.
------	-----------------------	---------	----------------	---------------	-----------------	--------------------	--------------	-----------

FS-1 · 1 switching output for slip monitoring; 1 switching output for overspeed/underspeed and acceptable range

	110...240 AC (50...60 Hz) / 27 DC (typ. 24 DC)	1	PNP / NPN / Namur	slip: 0.1...99.9 % rotational speed (frequency): 1...60000 pulses/min (0.1...1000)	2	2	1	DS2503
---	--	---	-------------------	--	---	---	---	--------

Slip monitors with sensor wire monitoring

Type	U _b [V]	In-puts	Input function	Setting range	Out-puts relays	Out-puts transist.	Draw-ing no.	Order no.
------	-----------------------	---------	----------------	---------------	-----------------	--------------------	--------------	-----------

FS-1N · 1 switching output for slip monitoring; 1 switching output for overspeed/underspeed and acceptable range

	110...240 AC (50...60 Hz) / 27 DC (typ. 24 DC)	1	Namur 8.2 V	slip: 0.1...99.9 % rotational speed (frequency): 1...60000 pulses/min (0.1...1000)	2	2	1	DS2603
---	---	---	-------------	--	---	---	---	--------

Slip / synchronous monitors

Type	U _b [V]	In-puts	Input function	Setting range	Out-puts relays	Out-puts transist.	Draw-ing no.	Order no.
------	-----------------------	---------	----------------	---------------	-----------------	--------------------	--------------	-----------

FS-2 · 2 switch points for slip/synchronous monitoring

	110...240 AC (50...60 Hz) / 27 DC (typ. 24 DC)	1	PNP / NPN / Namur	pulse differences: 1...999 reset time: 0.0...1000.0 s	2	2	1	DS2505
---	---	---	-------------------	--	---	---	---	--------

FS-3 · 2 switch points for synchronous monitoring

	110...240 AC (50...60 Hz) / 27 DC (typ. 24 DC)	1	PNP / NPN / Namur	pulse differences: 1...999 hysteresis: 1...999	2	2	1	DS2506
---	---	---	-------------------	---	---	---	---	--------

Slip / synchronous monitors with sensor wire monitoring

Type	U _b [V]	In-puts	Input function	Setting range	Out-puts relays	Out-puts transist.	Draw-ing no.	Order no.
------	-----------------------	---------	----------------	---------------	-----------------	--------------------	--------------	-----------

FS-2N · 2 switch points for slip/synchronous monitoring

	110...240 AC (50...60 Hz) / 27 DC (typ. 24 DC)	1	Namur 8.2 V	pulse differences: 1...999 reset time: 0.0...1000.0 s	2	2	1	DS2605
---	---	---	-------------	--	---	---	---	--------

Combined direction and speed monitors

Type	U _b [V]	In-puts	Input function	Setting range	Out-puts relays	Out-puts transist.	Draw-ing no.	Order no.
------	-----------------------	---------	----------------	---------------	-----------------	--------------------	--------------	-----------

FD-1 · 1 switching output for indication of direction; 1 switching output for overspeed/underspeed and acceptable range

	110...240 AC (50...60 Hz) / 27 DC (typ. 24 DC)	1	PNP / NPN / Namur	cycle time: 0.0...1000 s rotational speed (frequency): 1...60000 pulses/min (1...1000)	2	2	1	DR2503
---	---	---	-------------------	--	---	---	---	--------

FD-2 · 2 switching outputs for separate indication of direction; adjustable reset times for standstill monitoring

	110...240 AC (50...60 Hz) / 27 DC (typ. 24 DC)	1	PNP / NPN / Namur	reset time: 0.0...1000 s	2	2	1	DR2505
---	---	---	-------------------	--------------------------	---	---	---	--------

Frequency-to-current converters

Type	U _b [V]	In-puts	Input function	Setting range [puls. / min.]	Setting range [Hz]	Out-puts analogue	Out-puts relays	Out-puts transist.	Draw-ing no.	Order no.
------	-----------------------	---------	----------------	---------------------------------	-----------------------	-------------------	-----------------	--------------------	--------------	-----------

FA-1 · Conversion of pulse sequences into analogue standard signals

	110...240 AC (50...60 Hz) / 27 DC (typ. 24 DC)	1	PNP / NPN / Namur	0...600000	0...10000	2	1	1	1	DW2503
---	---	---	-------------------	------------	-----------	---	---	---	---	--------

Safety standstill monitors, SIL 3, PL e

Type	U _b [V]	In-puts	Input function	Setting range [puls. / min.]	Setting range [Hz]	Out-puts analogue	Out-puts relays	Out-puts transist.	Draw-ing no.	Order no.
------	-----------------------	---------	----------------	---------------------------------	-----------------------	-------------------	-----------------	--------------------	--------------	-----------

Monitoring rotational or linear movements for minimum switch point not reached (standstill)

	24 DC	1	PNP	–	0.2 / 0.5 / 1.0 / 2.0	–	2	1	5	DA101S
	24 DC	1	PNP	–	0.2 / 0.5 / 1.0 / 2.0	–	2	1	5	DA102S

Safety speed monitor, SIL 3, PL e

Type	U _b [V]	In-puts	Input function	Setting range [puls. / min.]	Setting range [Hz]	Out-puts analogue	Out-puts relays	Out-puts transist.	Draw-ing no.	Order no.
------	-----------------------	---------	----------------	---------------------------------	-----------------------	-------------------	-----------------	--------------------	--------------	-----------

Monitoring of rotational or linear movements for adherence to a maximum setpoint (overspeed)

	24 DC	1	PNP	–	-40...70	–	2	1	6	DD110S
	24 DC	1	PNP	–	-40...70	–	2	1	6	DD111S

Monitoring rotational or linear movements for minimum switch point not reached (underspeed)

	24 DC	1	PNP	–	-40...70	–	2	1	6	DU110S
---	-------	---	-----	---	----------	---	---	---	---	--------

Multifunctional displays for digital signals / frequency input

Type	U _b [V]	In-puts	Input function	Setting range [puls. / min.]	Setting range [Hz]	Out-puts analogue	Out-puts relays	Out-puts transist.	Drawing no.	Order no.
------	-----------------------	---------	----------------	---------------------------------	-----------------------	-------------------	-----------------	--------------------	-------------	-----------

FX 360 · universal evaluation and display for all physical units which can be derived from pulse sequences

	115/230	2	PNP / NPN	–	–	–	–	–	7	DX2001
	115/230	2	PNP / NPN	–	–	2	–	–	7	DX2002
	115/230	2	PNP / NPN	–	–	–	–	2	7	DX2003

Universal counters

Type	U _b [V]	In-puts	Input function	Setting range	Out-puts relays	Out-puts transist.	Drawing no.	Order no.
------	-----------------------	---------	----------------	---------------	-----------------	--------------------	-------------	-----------

preset counter with 2 presets

	90...260 AC	1	PNP / NPN	–	2	–	8	E89005
---	-------------	---	-----------	---	---	---	---	--------

2-channel threshold relay for analogue standard signals

Type	U _b [V]	In-puts	Input function	Setting range [puls. / min.]	Setting range [Hz]	Out-puts analogue	Out-puts relays	Out-puts transist.	Drawing no.	Order no.
------	-----------------------	---------	----------------	---------------------------------	-----------------------	-------------------	-----------------	--------------------	-------------	-----------

AL-3 · 2-channel analogue threshold relay for analogue standard signals

	110...240 AC (50...60 Hz) / 27 DC (typ. 24 DC)	2	2 x 0/4...20 mA	–	–	1	1	1	1	DL2503
---	---	---	-----------------	---	---	---	---	---	---	--------

Multifunctional displays for analogue standard signals

Type	U _b [V]	In-puts	Input function	Setting range [puls. / min.]	Setting range [Hz]	Out-puts analogue	Out-puts relays	Out-puts transist.	Drawing no.	Order no.
------	-----------------------	---------	----------------	---------------------------------	-----------------------	-------------------	-----------------	--------------------	-------------	-----------

AX 360 · universal unit for the display of analogue standard signals (e.g. of pressure, temperature, or flow sensors)

	115/230	2	0/4...20 mA / 0...10 V	–	–	–	–	–	7	DX2011
	115/230	2	0/4...20 mA / 0...10 V	–	–	–	–	2	7	DX2012

Type	U _b [V]	In-puts	Input function	Setting range [puls. / min.]	Setting range [Hz]	Out-puts analogue	Out-puts relays	Out-puts transist.	Draw-ing no.	Order no.
------	-----------------------	---------	----------------	---------------------------------	-----------------------	-------------------	-----------------	--------------------	--------------	-----------

scalable display for sensors with analogue output (e.g. pressure sensors, flow sensors)

	-	1	4...20 mA	-	-	-	-	-	9	E89150
---	---	---	-----------	---	---	---	---	---	---	--------



Timer relays with switch-on / switch-off delay

Type	U _b [V]	In-puts	Input function	Setting range [puls. / min.]	Setting range [Hz]	Out-puts analogue	Out-puts relays	Out-puts transist.	Draw-ing no.	Order no.
------	-----------------------	---------	----------------	---------------------------------	-----------------------	-------------------	-----------------	--------------------	--------------	-----------

T700 · power supply and switching amplifier with timer function (e.g. for sensors)



	-	2	0/4...20 mA / 0...10 V	-	-	-	-	-	10	DT0001
---	---	---	---------------------------	---	---	---	---	---	----	--------

Accessories pulse divider / pulse stretcher

Type	Description	Draw-ing no.	Order no.
	Pulse divider · Ratio input/output pulse 10:1 · Housing for DIN rail mounting · plastics	11	E80100
	Pulse divider · Division 1...255	12	E80102
	Pulse stretcher · Pulse length · IN (min): > 0.2 ms / OUT: 25 ms · Housing for DIN rail mounting · plastics	11	E80110

Accessories

Type	Description	Order no.
	Angle bracket · for type M18 · Housing materials: stainless steel	E10736
	Angle bracket · for type M30 · Housing materials: stainless steel	E10737
	Mounting clamp · Ø 20 mm · Ø 18 mm · with reducing bush · for type M18 · Housing materials: PBT	E10076
	Mounting clamp · Ø 34 mm · Ø 30 mm · with reducing bush · for type M30 · Housing materials: PBT	E10077

Type	Description	Order no.
	Target wheel · Plastic disk with 8 screws as "target" · Centered drill holes	E89010
	Target for pulse pickups · Strap dimensions 7 x 145 mm	E89013

Scale drawings / drawing no. – CAD download: www.ifm.com

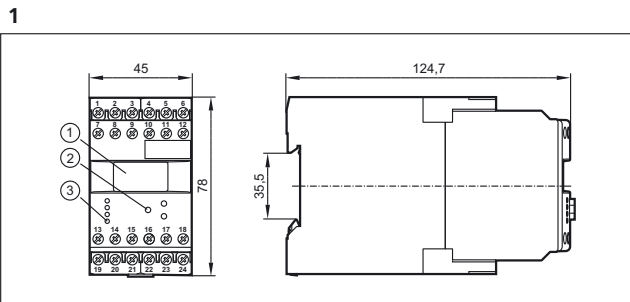

1: OLED display, 2: Programming buttons, 3: LEDs

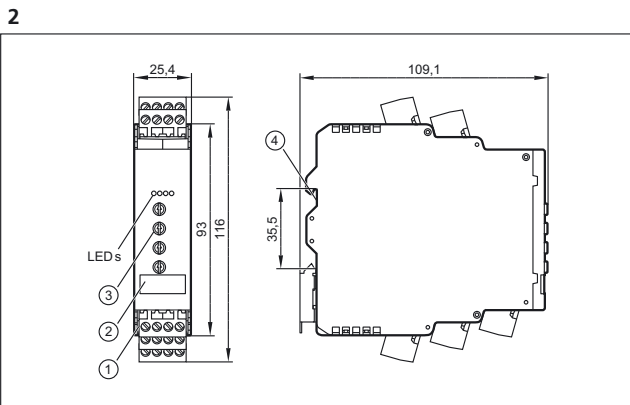

1: plug-in screw terminals, 2: label, 3: potentiometer, 4: Mounting on DIN rail

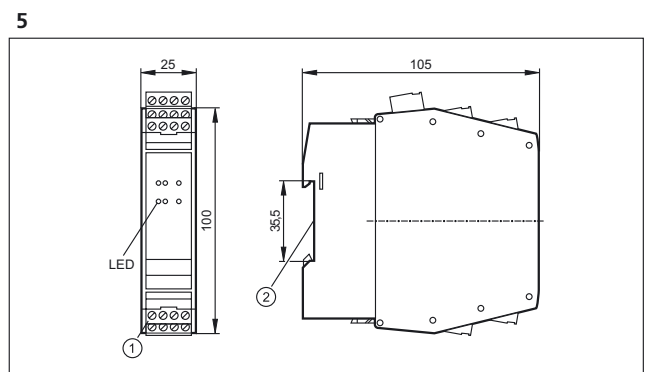
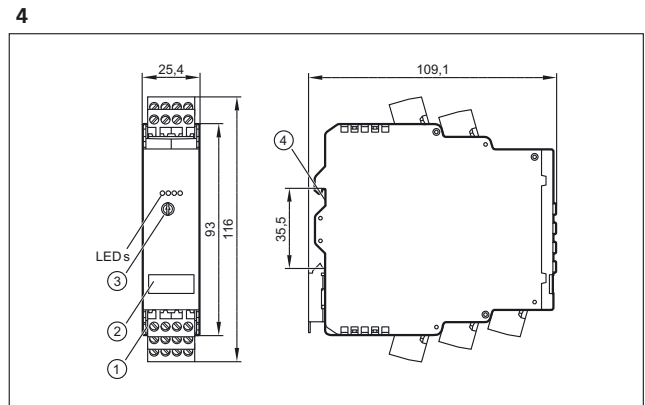
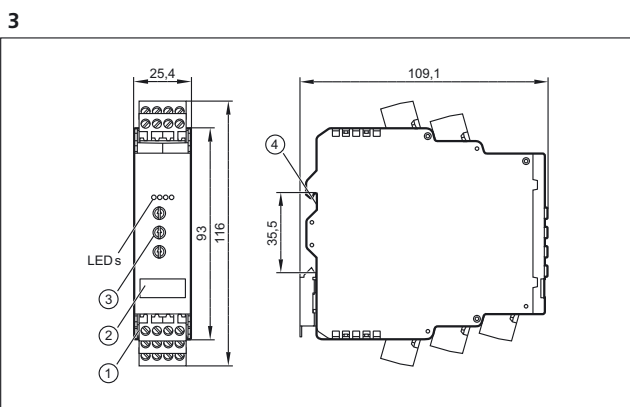

1: Combicon connector with screw terminals, 2: Mounting on DIN rail

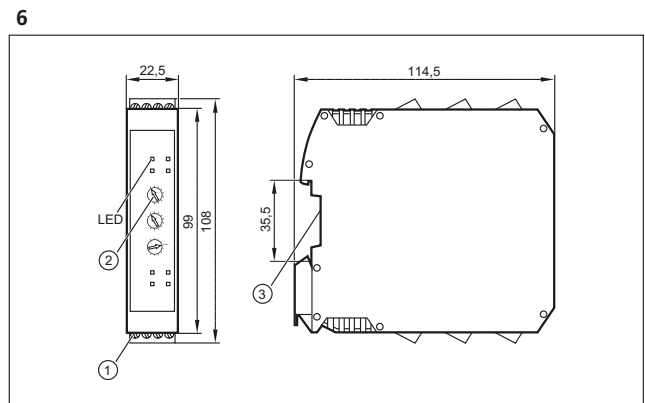

1: screw terminals, 2: Rotary switch, 3: Mounting on DIN rail

Scale drawings / drawing no. – CAD download: www.ifm.com

7

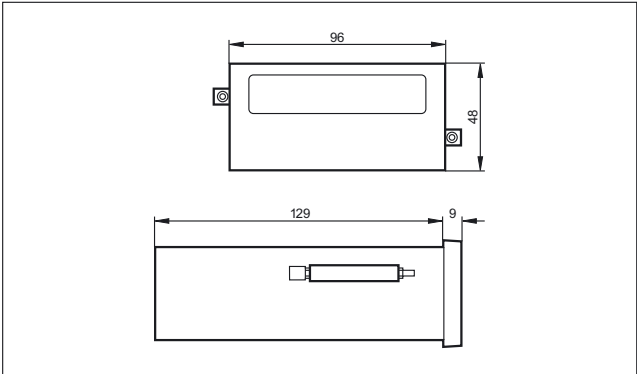

10

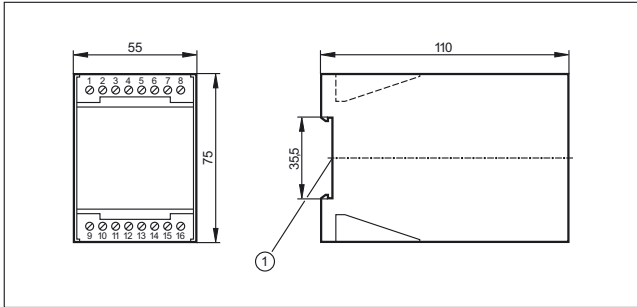

1: Mounting on DIN rail

8

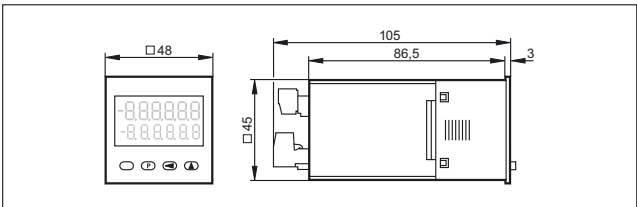

11

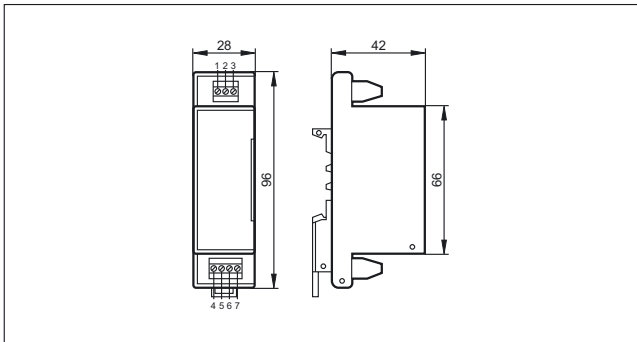

9

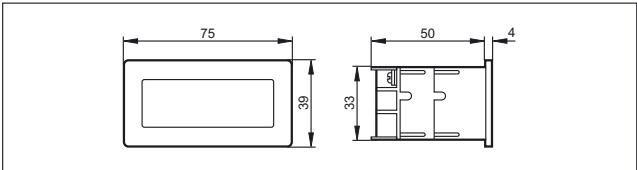

control panel cutout: 68 x 33 mm (according to DIN)

12

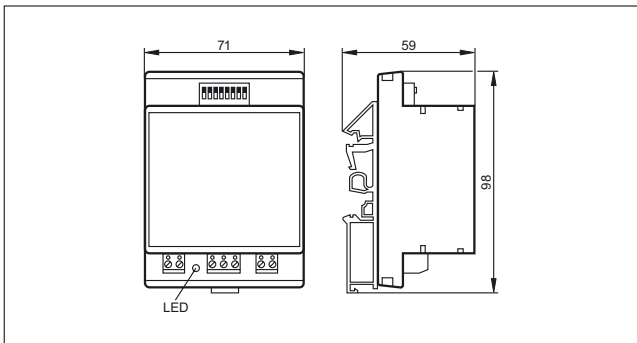

Detected at a glance



The power of a camera system with the simplicity of a sensor

In automation technology vision sensors are nowadays an integral part of assembly and manufacturing tasks as well as quality control and also a means of increasing efficiency. Vision sensors are cameras with application-specific evaluation, i.e. reliable electronic eyes at a low cost and a high degree of integration.

While a few years ago expensive camera systems were necessary, technical advancements and a continued decline in component prices have made it possible to integrate more and more intelligent functions into even smaller devices at a low cost. Not only do compact vision sensors replace camera systems, but they also offer additional application options. They are for example used to detect objects that have variable positions or shapes, replacing complex proximity switches or multiple sensor solutions such as sensor bridges used for completeness checks of pallets or crates.

Completeness check in the bottling process with efector pmd3d.







Easy to integrate

One of the distinguishing features of vision sensors is their simplicity. This means that they can be used without any specific prior knowledge. All units have switching outputs to confirm pass / fail conditions. So vision sensors offer the same ease of use as binary sensors. An Ethernet process interface is used for data transmission, parameter setting and remote monitoring.

Robust and compact

Another advantage: the high protection ratings and wide temperature ranges of ifm vision sensors make it possible to install them close to the objects to be monitored. In contrast to complex camera solutions, all necessary components such as lighting, optics, evaluation electronics and output logic are integrated in the industrial housing. With ifm vision sensors tasks such as quality and completeness checks can now be solved easily and at a low cost.

	Vision sensors	368 - 372
	3D sensors	374 - 376
	3D cameras	378 - 381
	Illumination	382 - 386





Vision sensors

Stand-alone unit with integrated lighting and evaluation in a robust, industrially compatible housing.
The electronic eye for monitoring presence, completeness, position, quality control as well as sorting tasks.





System overview	Page
Object inspection sensors	368 - 369
Sensors for object recognition	369
Software for vision sensors	370
Panel PC for vision sensors	370
Fixing components for vision sensors	370 - 371
Reflective tapes, diffusers and protective panes for vision sensors	372
Scale drawings / drawing no. – CAD download: www.ifm.com	372

Object inspection sensors

Type	Operating principle	Max. field of view size [mm]	Resolution [mm]	Detection rate [Hz]	Type of light	Ambient temperature [°C]	Drawing no.	Order no.
Type O2V · M12 plug, 8 poles M12 socket, 4 poles · metal · DC · PNP · Connector groups 16, 17								
	CMOS image sensor B/W, VGA resolution 640 x 480	640 x 480	0.025	10	White light	-10...60	1	O2V100
	CMOS image sensor B/W, VGA resolution 640 x 480	640 x 480	0.025	10	Infrared	-10...60	1	O2V120
	CMOS image sensor B/W, VGA resolution 640 x 480	1320 x 945	0.075	10	White light	-10...60	1	O2V102
	CMOS image sensor B/W, VGA resolution 640 x 480	1320 x 945	0.075	10	Infrared	-10...60	1	O2V122
	CMOS image sensor B/W, VGA resolution 640 x 480	400 x 300	0.02	10	White light	-10...60	2	O2V104
	CMOS image sensor B/W, VGA resolution 640 x 480	400 x 300	0.02	10	Infrared	-10...60	2	O2V124

Type	Operating principle	Max. field of view size [mm]	Resolution [mm]	Detection rate [Hz]	Type of light	Ambient temperature [°C]	Draw- ing no.	Order no.
Type O2V · M12 plug, 8 poles M12 socket, 4 poles · metal · DC · NPN · Connector groups 16, 17								
	CMOS image sensor B/W, VGA resolution 640 x 480	640 x 480	0.025	10	White light	-10...60	1	O2V101
	CMOS image sensor B/W, VGA resolution 640 x 480	640 x 480	0.025	10	Infrared	-10...60	1	O2V121
	CMOS image sensor B/W, VGA resolution 640 x 480	1320 x 945	0.075	10	White light	-10...60	1	O2V103
	CMOS image sensor B/W, VGA resolution 640 x 480	1320 x 945	0.075	10	Infrared	-10...60	1	O2V123
	CMOS image sensor B/W, VGA resolution 640 x 480	400 x 300	0.02	10	White light	-10...60	2	O2V105
	CMOS image sensor B/W, VGA resolution 640 x 480	400 x 300	0.02	10	Infrared	-10...60	2	O2V125



Sensors for object recognition

Type	Operating principle	Max. field of view size [mm]	Resolution [mm]	Detection rate [Hz]	Type of light	Ambient temperature [°C]	Draw- ing no.	Order no.
Type O2D2 · M12 plug, 8 poles · M12 socket, 4 poles · metal · DC · PNP · Connector groups 16, 17								
	CMOS image sensor B/W, VGA resolution 640 x 480	400 x 300	0.02	10	Infrared	-10...60	2	O2D224
	CMOS image sensor B/W, VGA resolution 640 x 480	640 x 480	0.025	10	Infrared	-10...60	1	O2D220
	CMOS image sensor B/W, VGA resolution 640 x 480	1320 x 945	0.075	10	Infrared	-10...60	1	O2D222
Type O2D2 · M12 plug, 8 poles · M12 socket, 4 poles · metal · DC · NPN · Connector groups 16, 17								
	CMOS image sensor B/W, VGA resolution 640 x 480	400 x 300	0.02	10	Infrared	-10...60	2	O2D225
	CMOS image sensor B/W, VGA resolution 640 x 480	640 x 480	0.025	10	Infrared	-10...60	1	O2D227
	CMOS image sensor B/W, VGA resolution 640 x 480	1320 x 945	0.075	10	Infrared	-10...60	1	O2D229

Software for vision sensors











Type	Description	Order no.
	Operating software · O2D	E2D200
	Operating software · O2V	E2V100

Panel PC for vision sensors

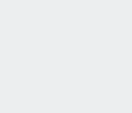

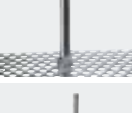

Type	Description	Order no.
	Touch Panel PC · 12.1" colour display · Intel Atom CPU 1.6 GHz · 2 GByte RAM · Windows Embedded Standard 7 SP1 (32 bits)	E2D400
	Mounting bracket · for Touch Panel PC · for wall mounting · VESA standard 100 x 100 mm · Housing materials: fixture: metal	E2D401
	Mounting set · for Touch Panel PC · for control cabinet mounting · Housing materials: fixture: metal / End cap: plastics	E2D402

Fixing components for vision sensors

Type	Description	Order no.
	Mounting set · O2D, O2M, O2I, O2V · Clamp mounting · rod mounting Ø 12 mm · Housing materials: fixture: stainless steel / clamp: stainless steel	E2D110
	Mounting set · O2D, O2M, O2I, O2V · Clamp mounting · rod mounting Ø 14 mm · Housing materials: fixture: stainless steel / clamp: stainless steel	E2D112
	Mounting set · Backlight 25 x 25 mm · Clamp mounting · Housing materials: Mounting plate: stainless steel / clamp: high-grade stainless steel	E2D107
	Mounting set · Backlight 50 x 50 mm · Clamp mounting · Housing materials: Mounting plate: stainless steel / clamp: high-grade stainless steel	E2D108
	Mounting set · Backlight 100 x 100 mm · Clamp mounting · Housing materials: Mounting plate: stainless steel / clamp: high-grade stainless steel	E2D109
	clamp · Ø 12 mm · rod mounting Ø 12 mm · Housing materials: clamp: stainless steel	E21110

Type	Description	Order no.
	clamp · Ø 14 mm · rod mounting Ø 14 mm · Housing materials: clamp: stainless steel	E21109
	clamp · Ø 12 mm; M10 · Free-standing M10 · Housing materials: clamp: stainless steel	E20946
	clamp · Ø 14 mm; M12 · free-standing M12 · Housing materials: clamp: stainless steel	E20948
	mounting rod · Ø 12 / M10 · Length: 130 mm · straight · Housing materials: stainless steel 316Ti / 1.4571	E20938
	mounting rod · Ø 12 / M10 · Length: 200 mm · angled · Housing materials: stainless steel 316Ti / 1.4571	E20940
	mounting rod · Ø 12 · Length: 150 mm · straight · Housing materials: stainless steel 316Ti / 1.4571	E21111
	mounting rod · Ø 12 · Length: 200 mm · straight · Housing materials: stainless steel 316Ti / 1.4571	E21112
	mounting rod · Ø 12 · Length: 300 mm · straight · Housing materials: stainless steel 316Ti / 1.4571	E21113
	mounting rod · Ø 14 / M12 · Length: 130 mm · straight · Housing materials: stainless steel 316Ti / 1.4571	E20939
	mounting rod · Ø 14 / M12 · Length: 200 mm · angled · Housing materials: stainless steel 316Ti / 1.4571	E20941
	Connection piece · Ø 20 mm · for the connection of two clamps with Ø 20 mm · Housing materials: stainless steel 316L / 1.4404	E21076
	Cube · M10 · aluminium profile · Housing materials: diecast zinc	E20951
	Cube · M12 · aluminium profile · Housing materials: diecast zinc	E20952

Reflective tapes, diffusers and protective panes for vision sensors

Type	Description	Order no.
	Reflective tape · TS-03 · 100 x 100 mm · Housing materials: plastics	E2D106
	Plastic diffuser · O2D / O2I · Housing materials: housing: diecast zinc black / lens: PMMA	E21165
	Plastic protective pane for the food industry · O2D / O2I · Housing materials: housing: diecast zinc black / lens: PMMA	E21166
	Glass protective pane · O2D / O2I · Housing materials: housing: diecast zinc black / lens: float glass	E21168
	Daylight filter · O2D · Housing materials: housing: diecast zinc black / lens: PMMA / Metal ring: aluminium black anodised / sealing: FPM 75+/-5 Shore A black	E21172

Scale drawings / drawing no. – CAD download: www.ifm.com

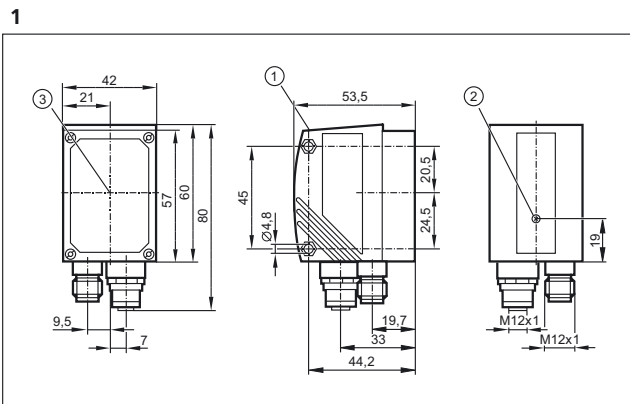

1: display, 2: Focus adjustment screw, 3: Centre of the lens axes

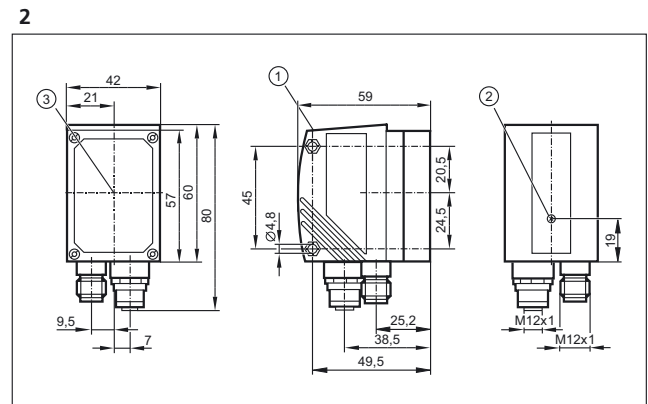

1: display, 2: Focus adjustment screw, 3: Centre of the lens axes





3D sensors



efector pmd 3d is the first industrial 3D sensor that can assess objects in three dimensions at a glance. Each pixel of this chip matrix evaluates its distance to the object. The image of the object on the chip matrix and the respective distance values correspond to a 3D image. The integrated evaluation enables the detailed assessment of the object's or scene's conditions by means of volume, distance or level detection in three dimensions or completeness monitoring for the packaging technology and Volume determination for storage and conveyor technology.

System overview	Page
3D sensors	374
Software for 3D sensors	375
Panel PC for vision sensors	375
Fixing components for 3D sensors	375
Scale drawings / drawing no. – CAD download: www.ifm.com	376



3D sensors

Type	Operating principle	Resolution (pixels)	Angle of aperture (horizontal x vertical) [°]	Lighting	Max. sampling rate [Hz]	Ambient temperature [°C]	Drawing no.	Order no.
PMD 3D sensor · Type O3D · M12 connector · metal · DC								
	PMD 3D sensor	64 x 48	40 x 30	Infrared LED	20	-10...50	1	O3D200
	PMD 3D sensor	64 x 48	64 x 48	Infrared LED	20	-10...50	2	O3D222
3D sensor · Type Smart Cam · M12 connector · metal · DC								
	3D sensor	176 x 132	40 x 30	Infrared LED	25	-10...50	3	O3D300
	3D sensor	176 x 132	60 x 45	Infrared LED	25	-10...50	4	O3D302
	3D sensor	176 x 132	40 x 30	Infrared LED	25	-10...50	3	O3D310
	3D sensor	176 x 132	60 x 45	Infrared LED	25	-10...50	4	O3D312

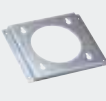

Software for 3D sensors

Type	Description	Order no.
	Operating software for PMD 3D sensor · O3D	E3D200
	Parameter setting software 3D sensor Smart Cam	E3D300

Panel PC for vision sensors

Type	Description	Order no.
	Touch Panel PC · 12.1" colour display · Intel Atom CPU 1.6 GHz · 2 GByte RAM · Windows Embedded Standard 7 SP1 (32 bits)	E2D400
	Mounting bracket · for Touch Panel PC · for wall mounting · VESA standard 100 x 100 mm · Housing materials: fixture: metal	E2D401
	Mounting set · for Touch Panel PC · for control cabinet mounting · Housing materials: fixture: metal / End cap: plastics	E2D402

Fixing components for 3D sensors

Type	Description	Order no.
	Mounting set · O3D · Clamp mounting · Type O3D · rod mounting Ø 14 mm · Housing materials: fixture: stainless steel / clamp: stainless steel	E3D103
	Mounting set · O3D · Clamp mounting · Type Smart Camera · rod mounting Ø 14 mm · Housing materials: fixture: stainless steel / clamp: stainless steel	E3D301
	mounting rod · Ø 14 / M12 · Length: 130 mm · straight · Housing materials: stainless steel 316Ti / 1.4571	E20939
	mounting rod · Ø 14 · Length: 200 mm · straight · Housing materials: stainless steel 316Ti / 1.4571	E21228
	mounting rod · Ø 14 · Length: 300 mm · straight · Housing materials: stainless steel 316Ti / 1.4571	E21229
	mounting rod · Ø 14 · Length: 500 mm · straight · Housing materials: stainless steel 316Ti / 1.4571	E21232

Scale drawings / drawing no. – CAD download: www.ifm.com

1

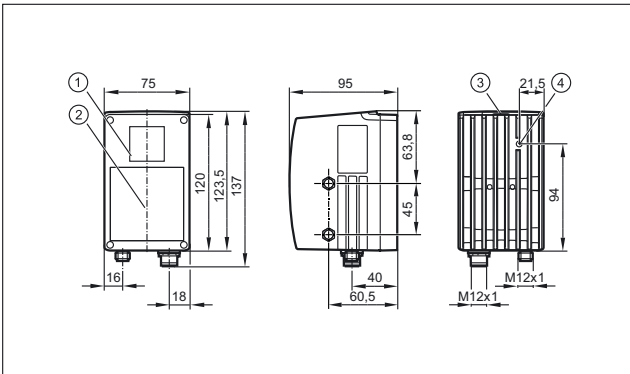

1: lens, 2: Illumination unit, 3: Display / buttons / LEDs, 4: Focus adjustment screw

3

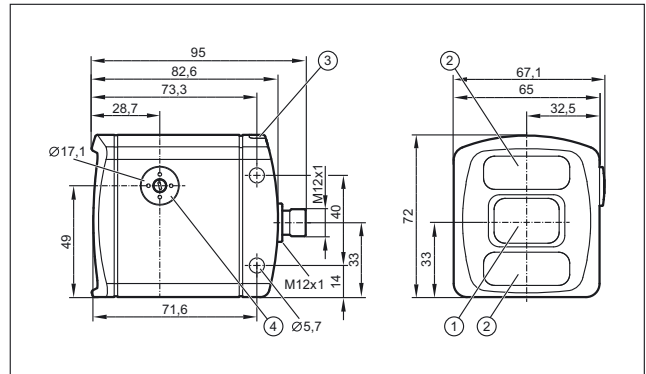

1: lens, 2: Illumination unit, 3: LED 2 colours (yellow/green), 4: Focus adjustment screw

2

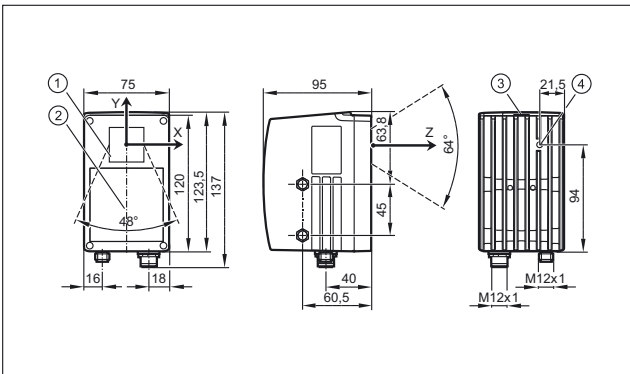

1: lens, 2: Illumination unit, 3: LED 2 colours (yellow/green), 4: Focus adjustment screw

4

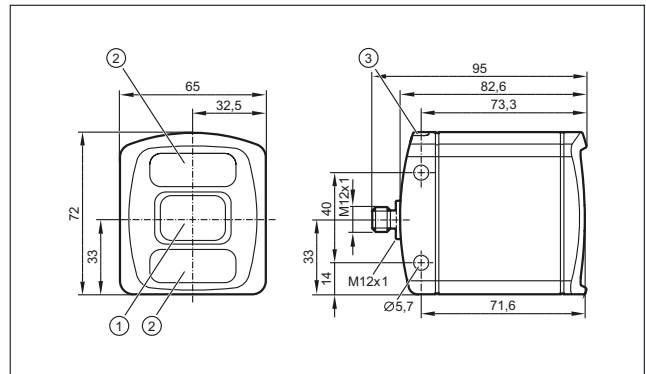

1: lens, 2: Illumination unit, 3: LED 2 colours (yellow/green)





3D cameras



The pmd 3d camera detects scenes and objects in their spatial dimensions at a glance. In contrast to laser scanners it does not require moving components and is thus robust and wear-free. The operating principle is the same as for the 3D sensor. Besides the 3D distance image the camera provides a grey image of the scene. The combination of these images offers the possibility to freely program application-specific tasks by means of a software development kit and connection to MATLAB, HALCON, PCL (Point Cloud Library) and ROS (Robot Operating System).

System overview	Page
3D cameras	378
Software for 3D cameras	379
Fixing components for 3D cameras	379
Connection cables for industrial imaging	379
Scale drawings / drawing no. – CAD download: www.ifm.com	381

3D cameras

Type	Operating principle	Resolution (pixels)	Angle of aperture (horizontal x vertical) [°]	Lighting	Max. sampling rate [Hz]	Ambient temperature [°C]	Drawing no.	Order no.
PMD 3D camera · Type O3D · M12 connector · metal · DC								
	PMD 3D camera	64 x 48	40 x 30	Infrared LED	20	-10...50	1	O3D201
	PMD 3D camera	64 x 48	64 x 48	Infrared LED	20	-10...50	2	O3D223
3D camera · Type Smart Cam · M12 connector · metal · DC								
	3D camera	176 x 132	40 x 30	Infrared LED	25	-10...50	3	O3D301
	3D camera	176 x 132	60 x 45	Infrared LED	25	-10...50	4	O3D303
	3D camera	176 x 132	40 x 30	Infrared LED	25	-10...50	3	O3D311
	3D camera	176 x 132	60 x 45	Infrared LED	25	-10...50	4	O3D313



Software for 3D cameras







Type	Description	Order no.
	Operating software for PMD 3D camera · O3D	E3D201
	Parameter setting software 3D sensor Smart Cam	E3D300

Fixing components for 3D cameras

Type	Description	Order no.
	Mounting set · O3D · Clamp mounting · Type O3D · rod mounting Ø 14 mm · Housing materials: fixture: stainless steel / clamp: stainless steel	E3D103
	Mounting set · O3D · Clamp mounting · Type Smart Camera · rod mounting Ø 14 mm · Housing materials: fixture: stainless steel / clamp: stainless steel	E3D301
	mounting rod · Ø 14 / M12 · Length: 130 mm · straight · Housing materials: stainless steel 316Ti / 1.4571	E20939
	mounting rod · Ø 14 · Length: 200 mm · straight · Housing materials: stainless steel 316Ti / 1.4571	E21228
	mounting rod · Ø 14 · Length: 300 mm · straight · Housing materials: stainless steel 316Ti / 1.4571	E21229
	mounting rod · Ø 14 · Length: 500 mm · straight · Housing materials: stainless steel 316Ti / 1.4571	E21232

Connection cables for industrial imaging

Type	Description	Order no.
	Jumper · straight / straight · Ethernet · Cross-over patch cable · 2 m · Housing materials: PUR / PC	E11898
	Jumper · straight / straight · Ethernet · Patch cable · 2 m · Housing materials: PUR / PC	E12090
	Jumper · straight / straight · Ethernet · Gold-plated contacts · 2 m · Housing materials: TPU	E21138

Type	Description	Order no.
	Jumper · straight / straight · Ethernet · Gold-plated contacts · 5 m · Housing materials: TPU	E21139
	Jumper · straight / straight · Ethernet · Gold-plated contacts · 10 m · Housing materials: TPU	E21137
	Jumper · straight / straight · Ethernet · Cross-over patch cable · 10 m · Housing materials: PUR / PC	E12204
	Jumper · straight / straight · Ethernet · Cross-over patch cable · 20 m · Housing materials: PUR / PC	E12205
	Socket · angled · Free from silicone · Free from halogen · Gold-plated contacts · M12 connector · 2 m · Housing materials: PUR	E11231
	Socket · angled · Free from silicone · Free from halogen · Gold-plated contacts · M12 connector · 5 m · Housing materials: PUR	E11232
	Socket · straight · Free from halogen · M12 connector · 5 m · Housing materials: PUR	E11807
	Socket · straight · Free from halogen · M12 connector · 10 m · Housing materials: PUR	E11311
	Socket · straight · Free from halogen · M12 connector · 2 m · Housing materials: PUR	E11950
	Adapter · angled · Connector	E21140
	Jumper · straight / straight · Ethernet · Cross-over patch cable · 2 m · Housing materials: PUR	EC2080
	Jumper · straight / straight · Ethernet · Cross-over patch cable · 5 m · Housing materials: PUR	E30112

Scale drawings / drawing no. – CAD download: www.ifm.com

1

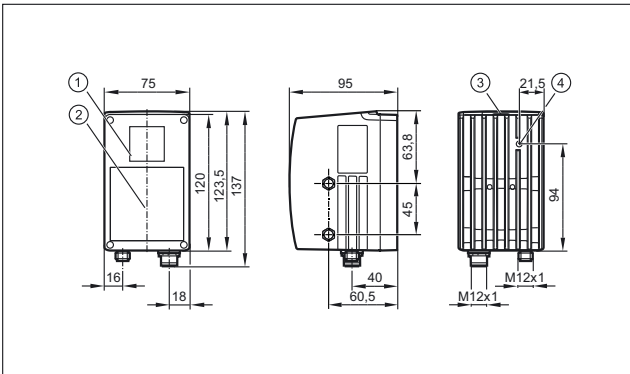

1: lens, 2: Illumination unit, 3: Display / buttons / LEDs, 4: Focus adjustment screw

3

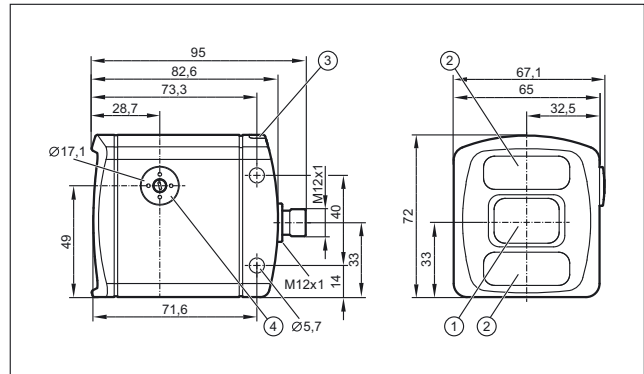

1: lens, 2: Illumination unit, 3: LED 2 colours (yellow/green), 4: Focus adjustment screw

2

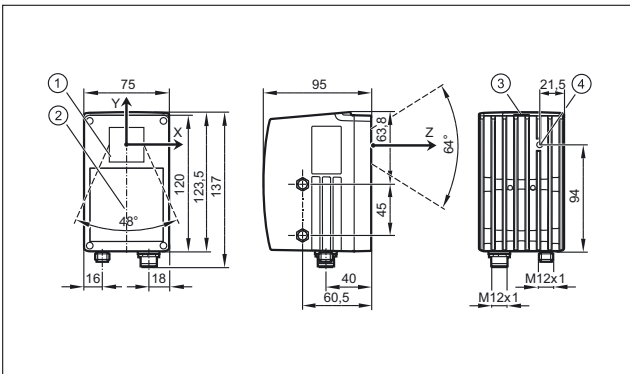

4

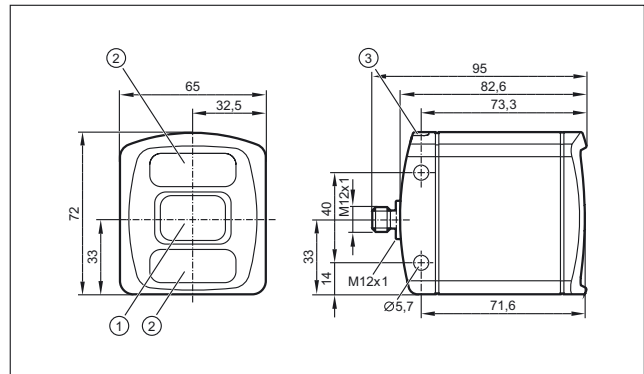

1: lens, 2: Illumination unit, 3: LED 2 colours (yellow/green)



Illumination





Very slim backlights for generating a precise silhouette. Versions with red light or infrared light available. Continuous operation or pulse mode with 4-fold light intensity.

System overview	Page
Illumination units, spotlight	382 - 383
Illumination units, backlight	383 - 384
Illumination units, spotlight	384
Accessories for illumination units	384
Wiring diagrams	385
Scale drawings / drawing no. – CAD download: www.ifm.com	385 - 386

Illumination units, spotlight



Type	Dimensions [mm]	Type of light	Active illuminated area [mm]	I ₀ normal light intensity [mA]	I ₀ high light intensity [mA]	Trigger	Drawing no.	Order no.
------	-----------------	---------------	------------------------------	--	--	---------	-------------	-----------

PUR cable with M12 connector 0.3 m · metal · DC · Wiring diagram no. 1 · Connector groups 8, 10, 18, 20, 120, 124, 126, 128, 157

	Ø 122 / L = 20.5	Red	Ø 66 / 106	800	1300	external; 24 V PNP	1	O2D915
	Ø 122 / L = 20.5	Infrared	Ø 66 / 106	800	1400	external; 24 V PNP	1	O2D917
	Ø 122 / L = 20.5	White light	Ø 66 / 106	800	1200	external; 24 V PNP	1	O2D919
	116 x 13 x 18	Red	Ø 66 / 106	225	375	external; 24 V PNP	2	O2D921
	200 x 13 x 18	Red	Ø 66 / 106	460	700	external; 24 V PNP	3	O2D924
	116 x 13 x 18	Infrared	Ø 66 / 106	185	325	external; 24 V PNP	2	O2D922
	200 x 13 x 18	Infrared	Ø 66 / 106	415	640	external; 24 V PNP	3	O2D925

Type	Dimensions [mm]	Type of light	Active illuminated area [mm]	I ₀ normal light intensity [mA]	I ₀ high light intensity [mA]	Trigger	Draw- ing no.	Order no.
------	--------------------	------------------	---------------------------------------	---	---	---------	---------------------	--------------

PUR cable with M12 connector 0.3 m · metal · DC · Wiring diagram no. 1 · Connector groups 8, 10, 18, 20, 120, 124, 126, 128, 157

	116 x 13 x 18	White light	Ø 66 / 106	165	275	external; 24 V PNP	2	O2D923
	200 x 13 x 18	White light	Ø 66 / 106	265	475	external; 24 V PNP	3	O2D926



PUR cable with M12 connector 0.3 m · metal · DC · Wiring diagram no. 2 · Connector groups 8, 10, 18, 20, 120, 124, 126, 128, 157

	155 x 130 x 9.8	Red	Ø 66 / 106	–	–	external; 24 V PNP	4	O2D920
---	-----------------	-----	------------	---	---	--------------------	---	--------



Illumination units, backlight



Type	Dimensions [mm]	Type of light	Active illuminated area [mm]	I ₀ normal light intensity [mA]	I ₀ high light intensity [mA]	Trigger	Draw- ing no.	Order no.
------	--------------------	------------------	---------------------------------------	---	---	---------	---------------------	--------------

PUR cable 2 m · metal · DC · Wiring diagram no. 3



	70.5 x 9.2 x 33.4	Red	25 x 25	50	25	External; 24 V PNP to IEC61131-1	5	O2D900
	70.5 x 9.2 x 33.4	Infrared	25 x 25	50	25	External; 24 V PNP to IEC61131-1	5	O2D901
	108 x 9.8 x 81	Red	50 x 50	200	100	External; 24 V PNP to IEC61131-1	6	O2D902
	108 x 9.8 x 81	Infrared	50 x 50	200	100	External; 24 V PNP to IEC61131-1	6	O2D903
	161.2 x 9.8 x 133	Red	100 x 100	450	250	External; 24 V PNP to IEC61131-1	7	O2D904
	161.2 x 9.8 x 133	Infrared	100 x 100	450	250	External; 24 V PNP to IEC61131-1	7	O2D905

PUR cable 0.15 m · metal · DC · Wiring diagram no. 1 · Connector groups 8, 10, 18, 20, 120, 124, 126, 128, 157





	70.5 x 9.2 x 33.4	Red	25 x 25	50	25	External; 24 V PNP to IEC61131-1	5	O2D910
	70.5 x 9.2 x 33.4	Infrared	25 x 25	50	25	External; 24 V PNP to IEC61131-1	5	O2D906
	108 x 9.8 x 81	Red	50 x 50	200	100	External; 24 V PNP to IEC61131-1	6	O2D911

Type	Dimensions [mm]	Type of light	Active illuminated area [mm]	I ₀ normal light intensity [mA]	I ₀ high light intensity [mA]	Trigger	Draw- ing no.	Order no.
PUR cable 0.15 m · metal · DC · Wiring diagram no. 1 · Connector groups 8, 10, 18, 20, 120, 124, 126, 128, 157								
	108 x 9.8 x 81	Infrared	50 x 50	200	100	External; 24 V PNP to IEC61131-1	6	O2D907
	161.2 x 9.8 x 133	Red	100 x 100	450	250	External; 24 V PNP to IEC61131-1	7	O2D912
	161.2 x 9.8 x 133	Infrared	100 x 100	450	250	External; 24 V PNP to IEC61131-1	7	O2D908

Illumination units, spotlight

Type	Dimensions [mm]	Type of light	Active illuminated area [mm]	I ₀ normal light intensity [mA]	I ₀ high light intensity [mA]	Trigger	Draw- ing no.	Order no.
M12 connector · metal · DC · Wiring diagram no. 1 · Connector groups 8, 10, 18, 20, 120, 124, 126, 128, 157								
	42 x 42 x 31	Red	–	180	90	External; 24 V PNP to IEC61131-1	8	O2D909
	42 x 42 x 32.2	Red	–	180	90	External; 24 V PNP to IEC61131-1	9	O2D913

Accessories for illumination units

Type	Description	Order no.
	Glass diffuser · Ring light · Housing materials: housing: aluminium black anodised / lens: glass	E2D202
	Mounting set · Ring light · Clamp mounting · Housing materials: Mounting bracket: stainless steel / clamp: high-grade stainless steel	E2D201
	Mounting set · Bar light · Clamp mounting · Housing materials: Mounting bracket: stainless steel / clamp: high-grade stainless steel	E2D114
	Mounting set · Bar light · Clamp mounting · for 4 bar lights 10x75 mm · Housing materials: Mounting bracket: stainless steel / clamp: high-grade stainless steel	E2D116
	Mounting set · Dark field light · Clamp mounting · Housing materials: Mounting bracket: stainless steel / clamp: high-grade stainless steel	E2D115

Wiring diagrams

Core colours

BK	black
BN	brown
BU	blue
WH	white

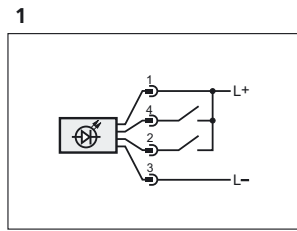

1: Trigger, 2: Operating mode "high light intensity"

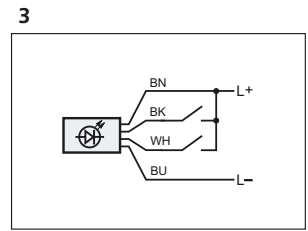
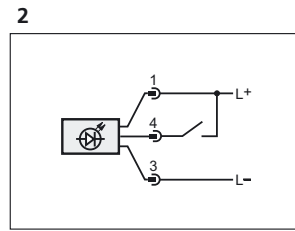

black: Trigger, white: Operating mode "high light intensity"

Scale drawings / drawing no. – CAD download: www.ifm.com

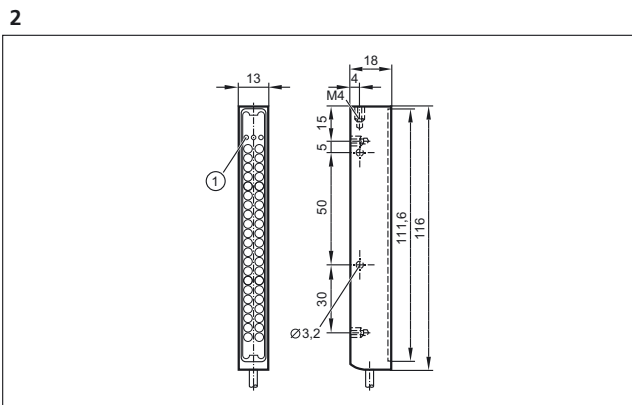
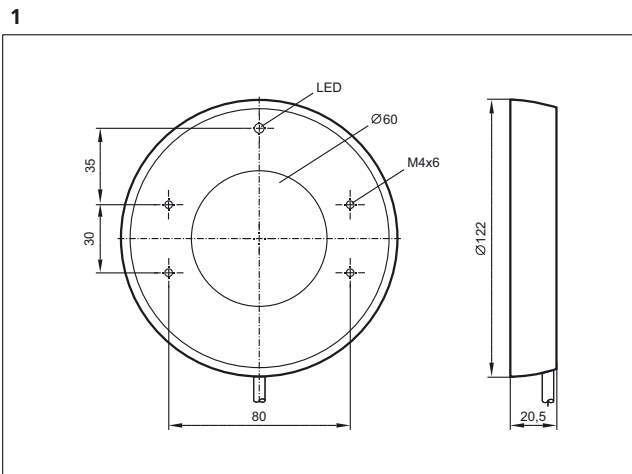

3 LED

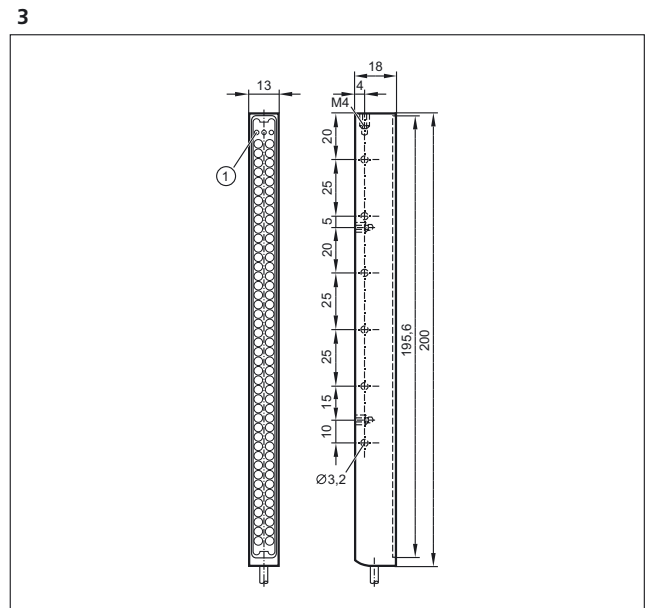

3 LED

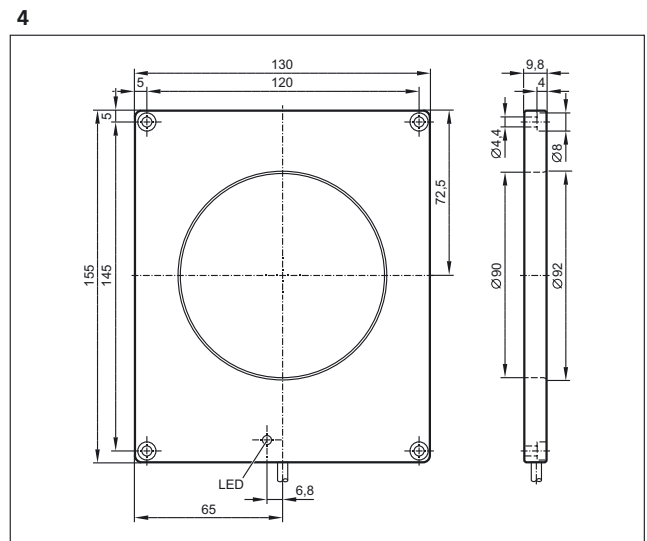

Scale drawings / drawing no. – CAD download: www.ifm.com

5

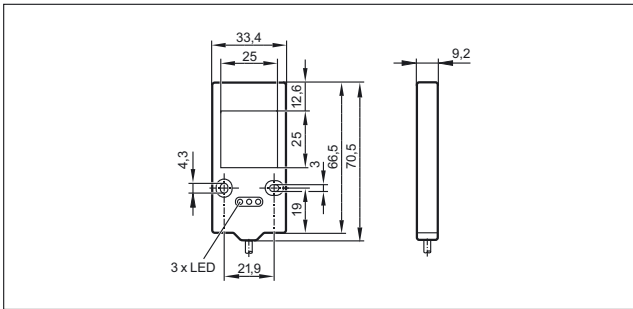

6

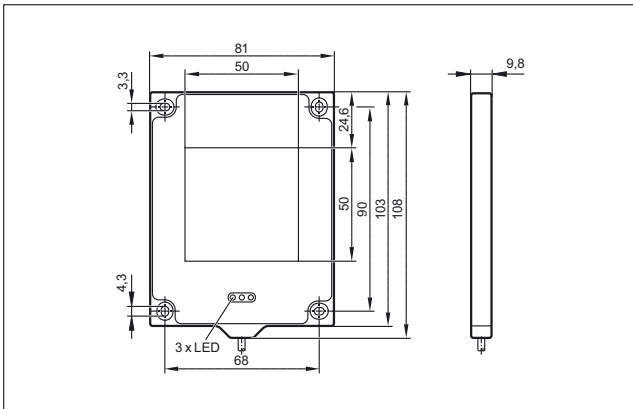

7

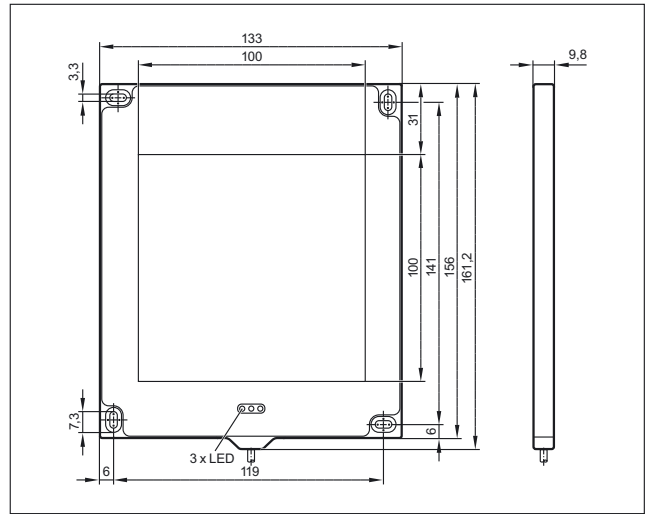

8

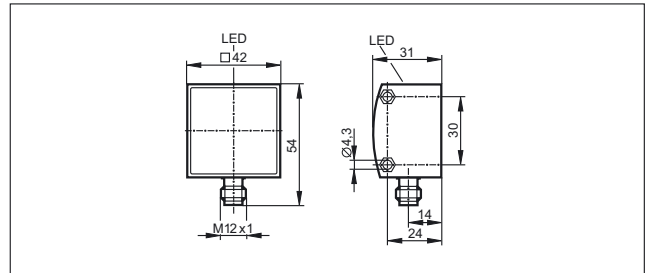

9

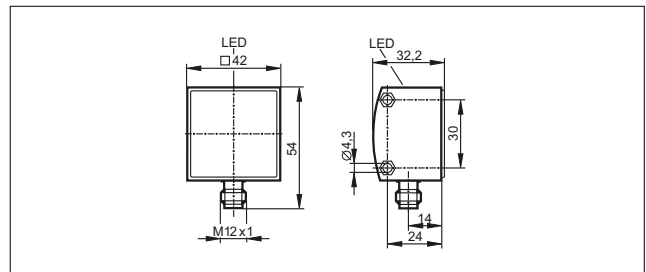



Functional safety



Area monitoring by means of safety light grids.



Applications

Today, automation technology can no longer be imagined without Functional Safety – not least because of the new EC Machinery Directive (2006/42/EC).

Its primary objective is to protect operators as stipulated by the Machinery Directive, whereby machinery should not present a risk. Moreover safety technology is an important guarantor of process protection and, in particular, of machine protection.

Approvals

A series of standards relates to the subject of Functional Safety. They specify different Safety Integrity Levels.







- IEC 61508: This standard is regarded as the basic safety standard and classifies safety products for automation by "Safety Integrity Levels" (SIL 1 – SIL 3).
- IEC 62061: This standard is based on IEC 61508 and determines "Safety Integrity Level Claim Limits" (SIL CL1 – SIL CL 3). These are comparable to the Safety Integrity Levels of IEC 61508. This standard specifies the design of control systems.
- ISO 13849-1: This standard is the successor to the previously applicable standard EN 954-1. In this standard "Performance Levels" (PL a to PL e) can be achieved. PL b-c correspond to SIL 1, PL d corresponds to SIL 2 and PL e corresponds to SIL 3. This standard covers the machinery sector.

- IEC 61496: This standard specifies general requirements for Electro-Sensitive Protective Equipment (ESPE) such as safety light grids. Variants are types 2 to 4.

Output versions

Output options include safe output stages such as OSSD outputs (Output Signal Switching Devices), outputs with a safe clock cycle that can be connected in series as well as relay outputs.

OSSD and pulsed outputs are the ideal choice for local safety-related tasks associated with controllers. Relay outputs are used to switch contactors. Moreover safe bus systems such as AS-i Safety at Work or CANopen Safety are available. Here the safe output stages can be directly connected to a safe bus. The safety-relevant information either remains in the local bus or can be transmitted up to the highest control level via bus couplers.

	<i>Fail-safe inductive sensors</i>	390 - 393
	<i>Safety light curtains</i>	394 - 413
	<i>Safety light grids</i>	414 - 421
	<i>Safety relays</i>	422 - 424
	<i>Safety controllers</i>	426 - 427
	<i>AS-Interface Safety at Work</i>	428 - 433

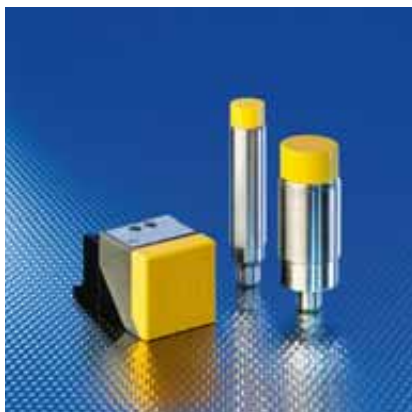





Fail-safe inductive sensors

Here you will find the first electronic fail-safe sensors which do not require a special counterpart but switch directly on the door or a stainless steel or mild steel target. They are wear-free and largely independent from mounting tolerances after a longer use of the doors.

System overview	Page
Fail-safe inductive sensors to IEC 61508 SIL 3, IEC 62061 SILcl 3 and ISO 13849-1 PL e with the possibility of connection in series	390
Inductive sensors for safety-related applications, 2 x OSSD, SIL 2, PL d	391
Inductive sensors for safety-related applications, 2 x OSSD, SIL 3, PL e	391
Accessories	392
Wiring diagrams	392
Scale drawings / drawing no. – CAD download: www.ifm.com	392 - 393

Fail-safe inductive sensors to IEC 61508 SIL 3, IEC 62061 SILcl 3 and ISO 13849-1 PL e with the possibility of connection in series



Type	Length [mm]	Enable zone [mm]	Housing material	U _b DC [V]	Protection	Response time in case of a safety request / enable time [ms]	Drawing no.	Order no.
M12 connector · Wiring diagram no. 3 · Connector groups 120, 124, 126, 128, 157								
	M18 / L = 90	3...6 nf	High-grade st. steel	24	IP 68 / IP 69K	≤ 20 / ≤ 200	1	GG505S
	M18 / L = 90.5	1...4 f	Brass	24	IP 68 / IP 69K	≤ 20 / ≤ 200	2	GG507S
	M30 / L = 80	6...12 nf	High-grade st. steel	24	IP 68 / IP 69K	≤ 20 / ≤ 200	3	GI505S
	M30 / L = 80	6...12 nf	High-grade st. steel	24	IP 68 / IP 69K	≤ 20 / ≤ 200	3	GI506S
	40 x 40 x 66	10...15 nf	PPE	24	IP 65 / IP 67	≤ 20 / ≤ 200	4	GM504S
	40 x 40 x 66	10...20 nf	PPE	24	IP 65 / IP 67	≤ 20 / ≤ 200	4	GM505S

f = flush / nf = non flush

Inductive sensors for safety-related applications, 2 x OSSD, SIL 2, PL d

Type	Length [mm]	Enable zone [mm]	Housing material	U _b DC [V]	Protection	Response time in case of a safety request / enable time [ms]	Drawing no.	Order no.
------	----------------	---------------------	------------------	-----------------------------	------------	---	-------------	-----------



M12 connector · Wiring diagram no. 1 · Connector groups 120, 124, 126, 128, 157

	M12 / L = 70	0.5...4 nf	High-grade st. steel	24	IP 65 / IP 67	≤ 1 / ≤ 1	5	GF711S
	M18 / L = 70.5	1...8 nf	High-grade st. steel	24	IP 65 / IP 67	≤ 1 / ≤ 1	6	GG711S
	M18 / L = 70	1...5 f	Brass	24	IP 65 / IP 67	≤ 1 / ≤ 1	7	GG712S

M12 connector · Wiring diagram no. 2 · Connector groups 120, 124, 126, 128, 157

	M18 / L = 86.5	> 10 f	Brass	24	IP 65 / IP 67	≤ 5 / ≤ 5	8	GG851S
---	-------------------	--------	-------	----	---------------	-----------	---	--------

M12 connector · Wiring diagram no. 1 · Connector groups 120, 124, 126, 128, 157



	M30 / L = 70	1...15 nf	High-grade st. steel	24	IP 65 / IP 67	≤ 10 / ≤ 1	9	GI711S
	M30 / L = 70	1...10 f	High-grade st. steel	24	IP 65 / IP 67	≤ 10 / ≤ 1	10	GI712S

f = flush / nf = non flush

Inductive sensors for safety-related applications, 2 x OSSD, SIL 3, PL e

Type	Length [mm]	Enable zone [mm]	Housing material	U _b DC [V]	Protection	Response time in case of a safety request / enable time [ms]	Drawing no.	Order no.
------	----------------	---------------------	------------------	-----------------------------	------------	---	-------------	-----------

M12 connector · Wiring diagram no. 1 · Connector groups 120, 124, 126, 128, 157

	M30 / L = 80	6...12 nf	High-grade st. steel	24	IP 68 / IP 69K	≤ 50 / ≤ 200	3	GI701S
	40 x 40 x 66	10...15 nf	PPE	24	IP 65 / IP 67	≤ 50 / ≤ 200	4	GM701S
	40 x 40 x 66	4...20 nf	PPE	24	IP 65 / IP 67	≤ 50 / ≤ 200	4	GM705S

f = flush / nf = non flush

Accessories

Type	Description	Order no.
	Safety T-splitter · M12 socket - 1 M12 connector / 1 M12 socket · T-piece for the pseudo-serial connection of fail-safe sensors · Housing materials: PUR	E11569

Wiring diagrams

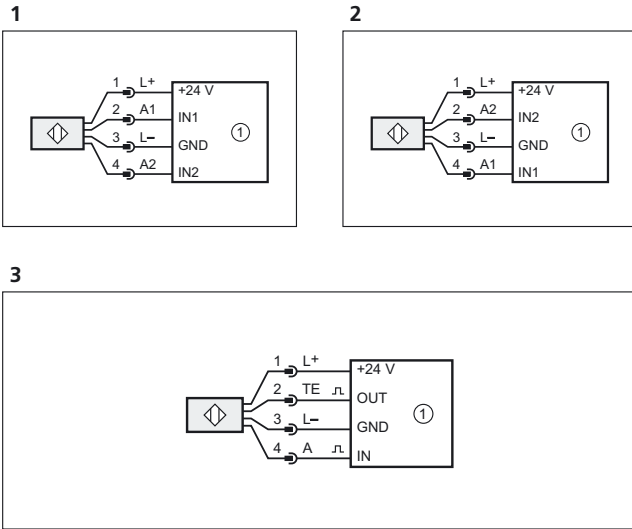

Scale drawings / drawing no. – CAD download: www.ifm.com

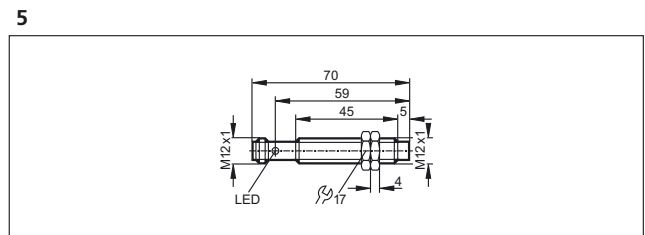
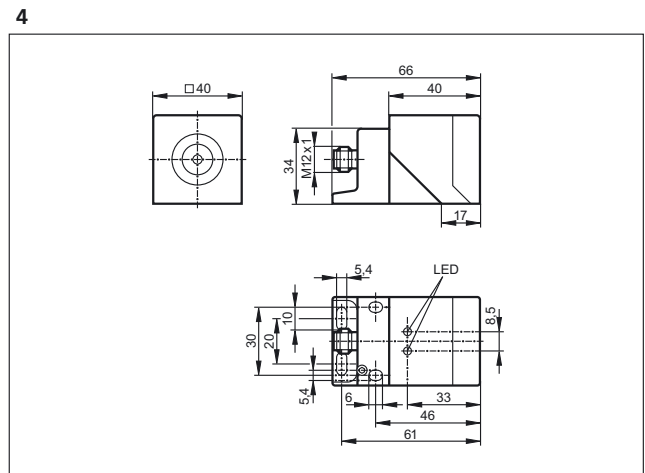
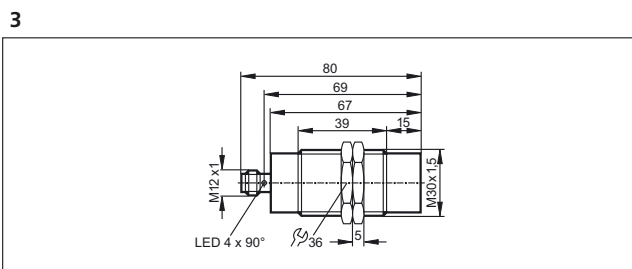
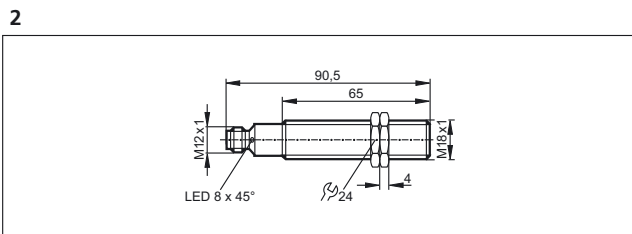
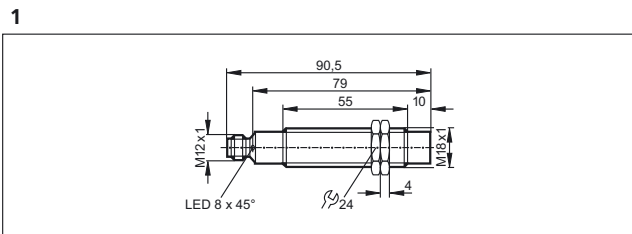

Scale drawings / drawing no. – CAD download: www.ifm.com

6

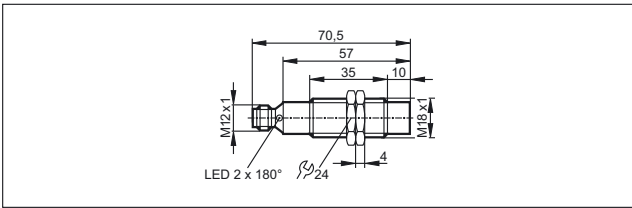

7

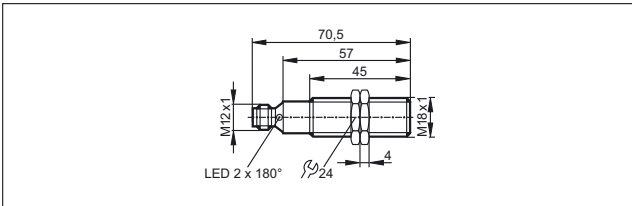

8

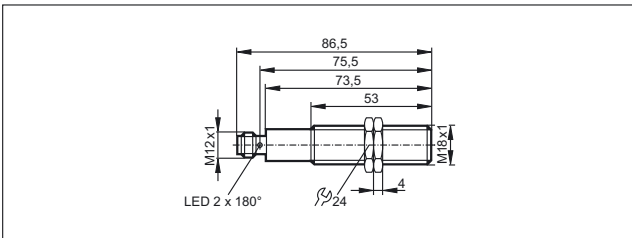

9

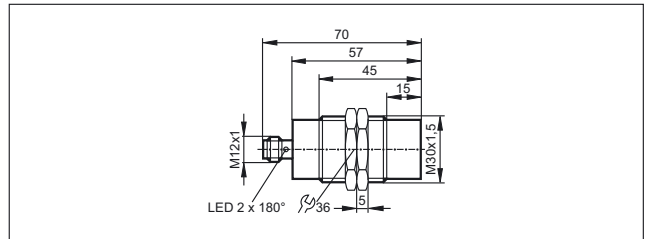

10

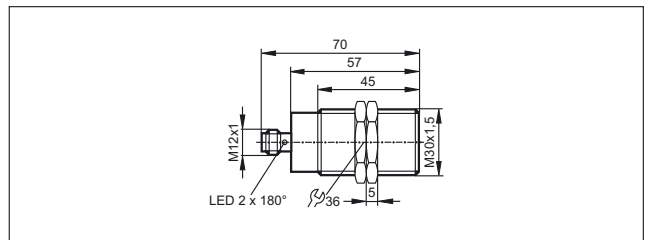



Safety light curtains

Wherever motion of machine parts presents a danger to people or goods, safety light curtains or safety light grids are used.

The protective equipment ensures that the outputs are switched off which results in a machine halt.

System overview	Page
Safety light curtains type 4, SIL 3, PL e, resolution 14 mm, protected area width up to 6 m	395
Safety light curtains type 4, SIL 3, PL e, resolution 20 mm, protected area width up to 20 m	396
Safety light curtains type 4, SIL 3, PL e, resolution 30 mm, protected area width up to 12 m	396 - 397
Safety light curtains type 4, SIL 3, PL e, resolution 30 mm, protected area width up to 20 m	397 - 398
Safety light curtains type 4, SIL 3, PL e, resolution 40 mm, protected area width up to 12 m	398
Safety light curtains type 4, SIL 3, PL e, resolution 40 mm, protected area width up to 20 m	399
Safety light curtains type 4, SIL 3, PL e, resolution 50 mm, protected area width up to 12 m	399 - 400
Safety light curtains type 4, SIL 3, PL e, resolution 50 mm, protected area width up to 20 m	400 - 401
Safety light curtains type 4, SIL 3, PL e, resolution 90 mm, protected area width up to 12 m	401
Safety light curtains type 4, SIL 3, PL e, resolution 90 mm, protected area width up to 20 m	401 - 402
Safety light curtains type 2, SIL 1, PL c, resolution 30 mm, protected area width up to 12 m	402
Safety light curtains type 2, SIL 1, PL c, resolution 40 mm, protected area width up to 12 m	403
Safety light curtains type 2, SIL 1, PL c, protected area width up to 12 m	403 - 404
Safety light curtains type 2, SIL 1, PL c, resolution 90 mm, protected area width up to 12 m	404
Safety light curtains for hygienic and wet areas, IP 69K, type 4, SIL 3, PL e, resolution 14 mm, protected area width up to 5 m	405
Safety light curtains for hygienic and wet areas, IP 69K, type 4, SIL 3, PL e, resolution 30 mm, protected area width up to 15 m	405
Safety light curtains for hygienic and wet areas, IP 69K, type 2, SIL 1, PL c, resolution 30 mm, protected area width up to 10 m	406
Safety light curtains with floating blanking type 4, SIL 3, PL e, resolution 14 mm, protected area width up to 5 m	406 - 407
Safety light curtains with floating blanking type 4, SIL 3, PL e, resolution 20 mm, protected area width up to 18 m	407
Safety light curtains with floating blanking type 4, SIL 3, PL e, resolution 40 mm, protected area width up to 18 m	407 - 408
Accessories for safety light curtains	408 - 409
Bases for safety light curtains	409 - 410
Bases for safety light curtains with corner mirror	410
Accessories necessary for bases	410

System overview	Page
Wiring diagrams	410 - 411
Scale drawings / drawing no. – CAD download: www.ifm.com	412 - 413

Safety light curtains type 4, SIL 3, PL e, resolution 14 mm, protected area width up to 6 m

Type	Sensor length [mm]	Resolution / detection capacity [mm]	Protected area height [mm]	Protected area width [m]	Response time [ms]	U _b [V]	Draw- ing no.	Order no.
------	-----------------------	--	----------------------------------	--------------------------------	--------------------------	-----------------------	---------------------	--------------

M12 connector · Wiring diagram no. 1, 2 · Connector groups 16, 17

	213	14	160	0...3 / 1...6	4	24	1	OY001S
	363	14	310	0...3 / 1...6	5.5	24	1	OY002S
	513	14	460	0...3 / 1...6	7.5	24	1	OY003S
	663	14	610	0...3 / 1...6	9	24	1	OY004S
	813	14	760	0...3 / 1...6	11	24	1	OY005S
	963	14	910	0...3 / 1...6	13	24	1	OY006S
	1113	14	1060	0...3 / 1...6	14.5	24	1	OY007S
	1263	14	1210	0...3 / 1...6	16.5	24	1	OY008S
	1413	14	1360	0...3 / 1...6	18	24	1	OY009S
	1563	14	1510	0...3 / 1...6	20	24	1	OY010S
	1863	14	1810	0...3 / 1...6	20	24	1	OY011S

Safety light curtains type 4, SIL 3, PL e, resolution 20 mm, protected area width up to 20 m

Type	Sensor length [mm]	Resolution / detection capacity [mm]	Protected area height [mm]	Protected area width [m]	Response time [ms]	U _b [V]	Draw- ing no.	Order no.
------	-----------------------	--	----------------------------------	--------------------------------	--------------------------	-----------------------	---------------------	--------------

M12 connector · Wiring diagram no. 1, 2 · Connector groups 16, 17

	213	20	160	0...10 / 3...20	4	24	1	OY221S
	363	20	310	0...10 / 3...20	5.5	24	1	OY222S
	513	20	460	0...10 / 3...20	7.5	24	1	OY223S
	663	20	610	0...10 / 3...20	9	24	1	OY224S
	813	20	760	0...10 / 3...20	11	24	1	OY225S
	963	20	910	0...10 / 3...20	13	24	1	OY226S
	1113	20	1060	0...10 / 3...20	14.5	24	1	OY227S
	1263	20	1210	0...10 / 3...20	16.5	24	1	OY228S
	1413	20	1360	0...10 / 3...20	18	24	1	OY229S
	1563	20	1510	0...10 / 3...20	20	24	1	OY230S

Safety light curtains type 4, SIL 3, PL e, resolution 30 mm, protected area width up to 12 m

Type	Sensor length [mm]	Resolution / detection capacity [mm]	Protected area height [mm]	Protected area width [m]	Response time [ms]	U _b [V]	Draw- ing no.	Order no.
------	-----------------------	--	----------------------------------	--------------------------------	--------------------------	-----------------------	---------------------	--------------

M12 connector · Wiring diagram no. 1, 2 · Connector groups 16, 17

	213	30	160	0...4 / 3...12	4	24	2	OY041S
	363	30	310	0...4 / 3...12	5.5	24	2	OY042S
	513	30	460	0...4 / 3...12	7.5	24	2	OY043S

Type	Sensor length [mm]	Resolution / detection capacity [mm]	Protected area height [mm]	Protected area width [m]	Response time [ms]	U _b [V]	Drawing no.	Order no.
------	-----------------------	--	----------------------------------	--------------------------------	--------------------------	-----------------------	----------------	--------------

M12 connector · Wiring diagram no. 1, 2 · Connector groups 16, 17

	663	30	610	0...4 / 3...12	8.5	24	2	OY044S
	813	30	760	0...4 / 3...12	10.5	24	2	OY045S
	963	30	910	0...4 / 3...12	12	24	2	OY046S
	1113	30	1060	0...4 / 3...12	14	24	2	OY047S
	1263	30	1210	0...4 / 3...12	15.5	24	2	OY048S
	1413	30	1360	0...4 / 3...12	17	24	2	OY049S
	1563	30	1510	0...4 / 3...12	18.5	24	2	OY050S

Safety light curtains type 4, SIL 3, PL e, resolution 30 mm, protected area width up to 20 m

Type	Sensor length [mm]	Resolution / detection capacity [mm]	Protected area height [mm]	Protected area width [m]	Response time [ms]	U _b [V]	Drawing no.	Order no.
------	-----------------------	--	----------------------------------	--------------------------------	--------------------------	-----------------------	----------------	--------------

M12 connector · Wiring diagram no. 1, 2 · Connector groups 16, 17

	213	30	160	0...10 / 3...20	3	24	1	OY241S
	363	30	310	0...10 / 3...20	4	24	1	OY242S
	513	30	460	0...10 / 3...20	5	24	1	OY243S
	663	30	610	0...10 / 3...20	6	24	1	OY244S
	813	30	760	0...10 / 3...20	6.5	24	1	OY245S
	963	30	910	0...10 / 3...20	7.5	24	1	OY246S
	1113	30	1060	0...10 / 3...20	8.5	24	1	OY247S

Type	Sensor length [mm]	Resolution / detection capacity [mm]	Protected area height [mm]	Protected area width [m]	Response time [ms]	U _b [V]	Draw- ing no.	Order no.
------	-----------------------	--	----------------------------------	--------------------------------	--------------------------	-----------------------	---------------------	--------------

M12 connector · Wiring diagram no. 1, 2 · Connector groups 16, 17

	1263	30	1210	0...10 / 3...20	9.5	24	1	OY248S
	1413	30	1360	0...10 / 3...20	10	24	1	OY249S
	1563	30	1510	0...10 / 3...20	11	24	1	OY250S

Safety light curtains type 4, SIL 3, PL e, resolution 40 mm, protected area width up to 12 m

Type	Sensor length [mm]	Resolution / detection capacity [mm]	Protected area height [mm]	Protected area width [m]	Response time [ms]	U _b [V]	Draw- ing no.	Order no.
------	-----------------------	--	----------------------------------	--------------------------------	--------------------------	-----------------------	---------------------	--------------

M12 connector · Wiring diagram no. 1, 2 · Connector groups 16, 17

	213	40	160	0...4 / 3...12	3.5	24	2	OY061S
	363	40	310	0...4 / 3...12	4.5	24	2	OY062S
	513	40	460	0...4 / 3...12	5.5	24	2	OY063S
	663	40	610	0...4 / 3...12	6.5	24	2	OY064S
	813	40	760	0...4 / 3...12	7.5	24	2	OY065S
	963	40	910	0...4 / 3...12	9	24	2	OY066S
	1113	40	1060	0...4 / 3...12	10	24	2	OY067S
	1263	40	1210	0...4 / 3...12	11	24	2	OY068S
	1413	40	1360	0...4 / 3...12	12	24	2	OY069S
	1563	40	1510	0...4 / 3...12	13	24	2	OY070S

Safety light curtains type 4, SIL 3, PL e, resolution 40 mm, protected area width up to 20 m

Type	Sensor length [mm]	Resolution / detection capacity [mm]	Protected area height [mm]	Protected area width [m]	Response time [ms]	U _b [V]	Draw- ing no.	Order no.
------	-----------------------	--	----------------------------------	--------------------------------	--------------------------	-----------------------	---------------------	--------------

M12 connector · Wiring diagram no. 1, 2 · Connector groups 16, 17

	213	40	160	0...10 / 3...20	3	24	1	OY261S
	363	40	310	0...10 / 3...20	3.5	24	1	OY262S
	513	40	460	0...10 / 3...20	4	24	1	OY263S
	663	40	610	0...10 / 3...20	4.5	24	1	OY264S
	813	40	760	0...10 / 3...20	5	24	1	OY265S
	963	40	910	0...10 / 3...20	6	24	1	OY266S
	1113	40	1060	0...10 / 3...20	6.5	24	1	OY267S
	1263	40	1210	0...10 / 3...20	7	24	1	OY268S
	1413	40	1360	0...10 / 3...20	7.5	24	1	OY269S
	1563	40	1510	0...10 / 3...20	8	24	1	OY270S

Safety light curtains type 4, SIL 3, PL e, resolution 50 mm, protected area width up to 12 m

Type	Sensor length [mm]	Resolution / detection capacity [mm]	Protected area height [mm]	Protected area width [m]	Response time [ms]	U _b [V]	Draw- ing no.	Order no.
------	-----------------------	--	----------------------------------	--------------------------------	--------------------------	-----------------------	---------------------	--------------

M12 connector · Wiring diagram no. 1, 2 · Connector groups 16, 17

	363	50	310	0...4 / 3...12	4	24	2	OY082S
	513	50	460	0...4 / 3...12	4.5	24	2	OY083S
	663	50	610	0...4 / 3...12	5.5	24	2	OY084S

Type	Sensor length [mm]	Resolution / detection capacity [mm]	Protected area height [mm]	Protected area width [m]	Response time [ms]	U _b [V]	Draw- ing no.	Order no.
------	-----------------------	--	----------------------------------	--------------------------------	--------------------------	-----------------------	---------------------	--------------

M12 connector · Wiring diagram no. 1, 2 · Connector groups 16, 17

	813	50	760	0...4 / 3...12	6.5	24	2	OY0855
	963	50	910	0...4 / 3...12	7.5	24	2	OY0865
	1113	50	1060	0...4 / 3...12	8.5	24	2	OY0875
	1263	50	1210	0...4 / 3...12	9	24	2	OY0885
	1413	50	1360	0...4 / 3...12	10	24	2	OY0895
	1563	50	1510	0...4 / 3...12	11	24	2	OY0905

Safety light curtains type 4, SIL 3, PL e, resolution 50 mm, protected area width up to 20 m

Type	Sensor length [mm]	Resolution / detection capacity [mm]	Protected area height [mm]	Protected area width [m]	Response time [ms]	U _b [V]	Draw- ing no.	Order no.
------	-----------------------	--	----------------------------------	--------------------------------	--------------------------	-----------------------	---------------------	--------------

M12 connector · Wiring diagram no. 1, 2 · Connector groups 16, 17

	363	50	310	0...10 / 3...20	3	24	1	OY2825
	513	50	460	0...10 / 3...20	3.5	24	1	OY2835
	663	50	610	0...10 / 3...20	4	24	1	OY2845
	813	50	760	0...10 / 3...20	4.5	24	1	OY2855
	963	50	910	0...10 / 3...20	5	24	1	OY2865
	1113	50	1060	0...10 / 3...20	5.5	24	1	OY2875
	1263	50	1210	0...10 / 3...20	6	24	1	OY2885
	1413	50	1360	0...10 / 3...20	6.5	24	1	OY2895

Type	Sensor length [mm]	Resolution / detection capacity [mm]	Protected area height [mm]	Protected area width [m]	Response time [ms]	U _b [V]	Draw- ing no.	Order no.
------	-----------------------	--	----------------------------------	--------------------------------	--------------------------	-----------------------	---------------------	--------------

M12 connector · Wiring diagram no. 1, 2 · Connector groups 16, 17



1563	50	1510	0...10 / 3...20	7	24	1	OY290S
------	----	------	-----------------	---	----	---	--------

Safety light curtains type 4, SIL 3, PL e, resolution 90 mm, protected area width up to 12 m

Type	Sensor length [mm]	Resolution / detection capacity [mm]	Protected area height [mm]	Protected area width [m]	Response time [ms]	U _b [V]	Draw- ing no.	Order no.
------	-----------------------	--	----------------------------------	--------------------------------	--------------------------	-----------------------	---------------------	--------------

M12 connector · Wiring diagram no. 1, 2 · Connector groups 16, 17

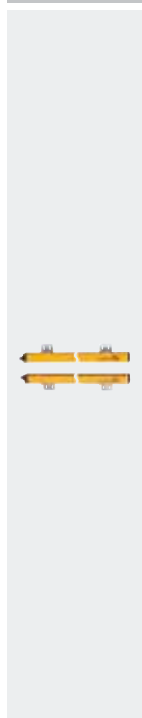

663	90	610	0...4 / 3...12	4	24	2	OY104S
-----	----	-----	----------------	---	----	---	--------

813	90	760	0...4 / 3...12	4.5	24	2	OY105S
-----	----	-----	----------------	-----	----	---	--------

963	90	910	0...4 / 3...12	5	24	2	OY106S
-----	----	-----	----------------	---	----	---	--------

1113	90	1060	0...4 / 3...12	5.5	24	2	OY107S
------	----	------	----------------	-----	----	---	--------

1263	90	1210	0...4 / 3...12	5.5	24	2	OY108S
------	----	------	----------------	-----	----	---	--------

1413	90	1360	0...4 / 3...12	6	24	2	OY109S
------	----	------	----------------	---	----	---	--------

1563	90	1510	0...4 / 3...12	6.5	24	2	OY110S
------	----	------	----------------	-----	----	---	--------

Safety light curtains type 4, SIL 3, PL e, resolution 90 mm, protected area width up to 20 m

Type	Sensor length [mm]	Resolution / detection capacity [mm]	Protected area height [mm]	Protected area width [m]	Response time [ms]	U _b [V]	Draw- ing no.	Order no.
------	-----------------------	--	----------------------------------	--------------------------------	--------------------------	-----------------------	---------------------	--------------

M12 connector · Wiring diagram no. 1, 2 · Connector groups 16, 17

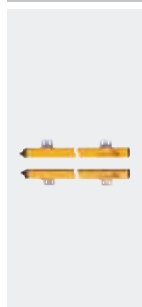

663	90	610	0...10 / 3...20	3	24	1	OY204S
-----	----	-----	-----------------	---	----	---	--------

813	90	760	0...10 / 3...20	3.5	24	1	OY205S
-----	----	-----	-----------------	-----	----	---	--------

963	90	910	0...10 / 3...20	3.5	24	1	OY206S
-----	----	-----	-----------------	-----	----	---	--------

Type	Sensor length [mm]	Resolution / detection capacity [mm]	Protected area height [mm]	Protected area width [m]	Response time [ms]	U _b [V]	Draw- ing no.	Order no.
------	-----------------------	--	----------------------------------	--------------------------------	--------------------------	-----------------------	---------------------	--------------

M12 connector - Wiring diagram no. 1, 2 - Connector groups 16, 17

	1113	90	1060	0...10 / 3...20	3.5	24	1	OY2075
	1263	90	1210	0...10 / 3...20	4	24	1	OY2085
	1413	90	1360	0...10 / 3...20	4	24	1	OY2095
	1563	90	1510	0...10 / 3...20	4.5	24	1	OY2105

Safety light curtains type 2, SIL 1, Pl c, resolution 30 mm, protected area width up to 12 m

Type	Sensor length [mm]	Resolution / detection capacity [mm]	Protected area height [mm]	Protected area width [m]	Response time [ms]	U _b [V]	Draw- ing no.	Order no.
------	-----------------------	--	----------------------------------	--------------------------------	--------------------------	-----------------------	---------------------	--------------

M12 connector - Wiring diagram no. 1, 2 - Connector groups 16, 17

	213	30	160	0...4 / 3...12	4.5	24	2	OY0315
	363	30	310	0...4 / 3...12	6	24	2	OY0325
	513	30	460	0...4 / 3...12	8	24	2	OY0335
	663	30	610	0...4 / 3...12	9.5	24	2	OY0345
	813	30	760	0...4 / 3...12	11	24	2	OY0355
	963	30	910	0...4 / 3...12	12.5	24	2	OY0365
	1113	30	1060	0...4 / 3...12	14.5	24	2	OY0375
	1263	30	1210	0...4 / 3...12	16	24	2	OY0385
	1413	30	1360	0...4 / 3...12	17.5	24	2	OY0395
	1563	30	1510	0...4 / 3...12	19.5	24	2	OY0405

Safety light curtains type 2, SIL 1, Pl c, resolution 40 mm, protected area width up to 12 m

Type	Sensor length [mm]	Resolution / detection capacity [mm]	Protected area height [mm]	Protected area width [m]	Response time [ms]	U _b [V]	Draw- ing no.	Order no.
------	-----------------------	--	----------------------------------	--------------------------------	--------------------------	-----------------------	---------------------	--------------

M12 connector · Wiring diagram no. 1, 2 · Connector groups 16, 17

	213	40	160	0...4 / 3...12	4	24	2	OY051S
	363	40	310	0...4 / 3...12	5	24	2	OY052S
	513	40	460	0...4 / 3...12	6	24	2	OY053S
	663	40	610	0...4 / 3...12	7	24	2	OY054S
	813	40	760	0...4 / 3...12	8	24	2	OY055S
	963	40	910	0...4 / 3...12	9.5	24	2	OY056S
	1113	40	1060	0...4 / 3...12	10.5	24	2	OY057S
	1263	40	1210	0...4 / 3...12	11.5	24	2	OY058S
	1413	40	1360	0...4 / 3...12	12.5	24	2	OY059S
	1563	40	1510	0...4 / 3...12	13.5	24	2	OY060S

Safety light curtains type 2, SIL 1, Pl c, protected area width up to 12 m

Type	Sensor length [mm]	Resolution / detection capacity [mm]	Protected area height [mm]	Protected area width [m]	Response time [ms]	U _b [V]	Draw- ing no.	Order no.
------	-----------------------	--	----------------------------------	--------------------------------	--------------------------	-----------------------	---------------------	--------------

M12 connector · Wiring diagram no. 1, 2 · Connector groups 16, 17

	363	50	310	0...4 / 3...12	4.5	24	2	OY072S
	513	50	460	0...4 / 3...12	5.5	24	2	OY073S
	663	50	610	0...4 / 3...12	6	24	2	OY074S

Type	Sensor length [mm]	Resolution / detection capacity [mm]	Protected area height [mm]	Protected area width [m]	Response time [ms]	U _b [V]	Draw- ing no.	Order no.
M12 connector · Wiring diagram no. 1, 2 · Connector groups 16, 17								
	813	50	760	0...4 / 3...12	7	24	2	OY075S
	963	50	910	0...4 / 3...12	8	24	2	OY076S
	1113	50	1060	0...4 / 3...12	9	24	2	OY077S
	1263	50	1210	0...4 / 3...12	10	24	2	OY078S
	1413	50	1360	0...4 / 3...12	10.5	24	2	OY079S
	1563	50	1510	0...4 / 3...12	11.5	24	2	OY080S

Safety light curtains type 2, SIL 1, Pl c, resolution 90 mm, protected area width up to 12 m

Type	Sensor length [mm]	Resolution / detection capacity [mm]	Protected area height [mm]	Protected area width [m]	Response time [ms]	U _b [V]	Draw- ing no.	Order no.
M12 connector · Wiring diagram no. 1, 2 · Connector groups 16, 17								
	663	90	610	0...4 / 3...12	4	24	2	OY094S
	813	90	760	0...4 / 3...12	4.5	24	2	OY095S
	963	90	910	0...4 / 3...12	5	24	2	OY096S
	1113	90	1060	0...4 / 3...12	5.5	24	2	OY097S
	1263	90	1210	0...4 / 3...12	6	24	2	OY098S
	1413	90	1360	0...4 / 3...12	6.5	24	2	OY099S
	1563	90	1510	0...4 / 3...12	7	24	2	OY100S

Safety light curtains for hygienic and wet areas, IP 69K, type 4, SIL 3, PL e, resolution 14 mm, protected area width up to 5 m

Type	Sensor length [mm]	Resolution / detection capacity [mm]	Protected area height [mm]	Protected area width [m]	Response time [ms]	U _b [V]	Drawing no.	Order no.
------	-----------------------	--	----------------------------------	--------------------------------	--------------------------	-----------------------	----------------	--------------

Cable 15 m · Wiring diagram no. 4, 5

	637	14	460	0...2 / 1...5	7.5	24	3	OY403S
	937	14	760	0...2 / 1...5	11	24	3	OY405S
	1237	14	1060	0...2 / 1...5	14.5	24	3	OY407S

Safety light curtains for hygienic and wet areas, IP 69K, type 4, SIL 3, PL e, resolution 30 mm, protected area width up to 15 m

Type	Sensor length [mm]	Resolution / detection capacity [mm]	Protected area height [mm]	Protected area width [m]	Response time [ms]	U _b [V]	Drawing no.	Order no.
------	-----------------------	--	----------------------------------	--------------------------------	--------------------------	-----------------------	----------------	--------------

Cable 15 m · Wiring diagram no. 4, 5

	337	30	160	0...7 / 3...15	3	24	3	OY441S
	487	30	310	0...7 / 3...15	4	24	3	OY442S
	637	30	460	0...7 / 3...15	5	24	3	OY443S
	787	30	610	0...7 / 3...15	6	24	3	OY444S
	937	30	760	0...7 / 3...15	6.5	24	3	OY445S
	1087	30	910	0...7 / 3...15	7.5	24	3	OY446S
	1237	30	1060	0...7 / 3...15	8.5	24	3	OY447S
	1387	30	1210	0...7 / 3...15	9.5	24	3	OY448S
	1537	30	1360	0...7 / 3...15	10	24	3	OY449S
	1687	30	1510	0...7 / 3...15	11	24	3	OY450S

Safety light curtains for hygienic and wet areas, IP 69K, type 2, SIL 1, Pl c, resolution 30 mm, protected area width up to 10 m

Type	Sensor length [mm]	Resolution / detection capacity [mm]	Protected area height [mm]	Protected area width [m]	Response time [ms]	U _b [V]	Draw- ing no.	Order no.
------	-----------------------	--	----------------------------------	--------------------------------	--------------------------	-----------------------	---------------------	--------------

Cable 15 m · Wiring diagram no. 4, 5

	337	30	160	0...3 / 2...10	4.5	24	4	OY431S
	487	30	310	0...3 / 2...10	6	24	4	OY432S
	637	30	460	0...3 / 2...10	8	24	4	OY433S
	787	30	610	0...3 / 2...10	9.5	24	4	OY434S
	937	30	760	0...3 / 2...10	11	24	4	OY435S
	1087	30	910	0...3 / 2...10	12.5	24	4	OY436S
	1237	30	1060	0...3 / 2...10	14.5	24	4	OY437S
	1387	30	1210	0...3 / 2...10	16	24	4	OY438S
	1537	30	1360	0...3 / 2...10	17.5	24	4	OY439S
	1687	30	1510	0...3 / 2...10	19.5	24	4	OY440S

Safety light curtains with floating blanking type 4, SIL 3, PL e, resolution 14 mm, protected area width up to 5 m

Type	Sensor length [mm]	Resolution / detection capacity [mm]	Protected area height [mm]	Protected area width [m]	Response time [ms]	U _b [V]	Draw- ing no.	Order no.
------	-----------------------	--	----------------------------------	--------------------------------	--------------------------	-----------------------	---------------------	--------------

M12 connector · Wiring diagram no. 1, 3 · Connector groups 16, 17

	711	14	610	0...3 / 0...5	11.5	24	5	OY804S
	861	14	760	0...3 / 0...5	13.5	24	5	OY805S
	1011	14	910	0...3 / 0...5	15.5	24	5	OY806S

Type	Sensor length [mm]	Resolution / detection capacity [mm]	Protected area height [mm]	Protected area width [m]	Response time [ms]	U _b [V]	Draw- ing no.	Order no.
------	-----------------------	--	----------------------------------	--------------------------------	--------------------------	-----------------------	---------------------	--------------

M12 connector · Wiring diagram no. 1, 3 · Connector groups 16, 17

	1161	14	1060	0...3 / 0...5	17	24	5	OY8075
	1311	14	1210	0...3 / 0...5	19	24	5	OY8085

Safety light curtains with floating blanking type 4, SIL 3, PL e, resolution 20 mm, protected area width up to 18 m

Type	Sensor length [mm]	Resolution / detection capacity [mm]	Protected area height [mm]	Protected area width [m]	Response time [ms]	U _b [V]	Draw- ing no.	Order no.
------	-----------------------	--	----------------------------------	--------------------------------	--------------------------	-----------------------	---------------------	--------------

M12 connector · Wiring diagram no. 1, 3 · Connector groups 16, 17

	711	20	610	0...6 / 3...18	11.5	24	5	OY8155
	861	20	760	0...6 / 3...18	13.5	24	5	OY8165
	1011	20	910	0...6 / 3...18	15.5	24	5	OY8175
	1161	20	1060	0...6 / 3...18	17	24	5	OY8185
	1311	20	1210	0...6 / 3...18	19	24	5	OY8195

Safety light curtains with floating blanking type 4, SIL 3, PL e, resolution 40 mm, protected area width up to 18 m



Type	Sensor length [mm]	Resolution / detection capacity [mm]	Protected area height [mm]	Protected area width [m]	Response time [ms]	U _b [V]	Draw- ing no.	Order no.
------	-----------------------	--	----------------------------------	--------------------------------	--------------------------	-----------------------	---------------------	--------------





M12 connector · Wiring diagram no. 1, 3 · Connector groups 16, 17

	711	40	610	0...6 / 3...18	8.5	24	5	OY8255
	861	40	760	0...6 / 3...18	9.5	24	5	OY8265
	1011	40	910	0...6 / 3...18	10.5	24	5	OY8275
	1161	40	1060	0...6 / 3...18	11.5	24	5	OY8285

Type	Sensor length [mm]	Resolution / detection capacity [mm]	Protected area height [mm]	Protected area width [m]	Response time [ms]	U _b [V]	Draw- ing no.	Order no.
M12 connector · Wiring diagram no. 1, 3 · Connector groups 16, 17								
	1311	40	1210	0...6 / 3...18	12.5	24	5	OY8295

Accessories for safety light curtains

Type	Description	Order no.
	Corner mirror · Length: 250 mm · for safety light curtains · Protected area height · 160 mm · for type OY · Housing materials: aluminium epoxy-powder coated / plastics / Accessories: steel galvanised	EY1001
	Corner mirror · Length: 400 mm · for safety light curtains · Protected area height · 310 mm · for type OY · Housing materials: aluminium epoxy-powder coated / plastics / Accessories: steel galvanised	EY1002
	Corner mirror · Length: 540 mm · for safety light curtains · Protected area height · 460 mm · for type OY · Housing materials: aluminium epoxy-powder coated / plastics / Accessories: steel galvanised	EY1003
	Corner mirror · Length: 715 mm · for safety light curtains · Protected area height · 610 mm · for safety light grids · 2 beams · for type OY · Housing materials: aluminium epoxy-powder coated / plastics / Accessories: steel galvanised	EY1004
	Corner mirror · Length: 885 mm · for safety light curtains · Protected area height · 760 mm · for type OY · Housing materials: aluminium epoxy-powder coated / plastics / Accessories: steel galvanised	EY1005
	Corner mirror · Length: 1060 mm · for safety light curtains · Protected area height · 910 mm · for safety light grids · 3 beams · for type OY · Housing materials: aluminium epoxy-powder coated / plastics / Accessories: steel galvanised	EY1006
	Corner mirror · Length: 1230 mm · for safety light curtains · Protected area height · 1060 mm · for safety light grids · 4 beams · for type OY · Housing materials: aluminium epoxy-powder coated / plastics / Accessories: steel galvanised	EY1007
	Corner mirror · Length: 1400 mm · for safety light curtains · Protected area height · 1210 mm · for type OY · Housing materials: aluminium epoxy-powder coated / plastics / Accessories: steel galvanised	EY1008
	Corner mirror · Length: 1450 mm · for safety light curtains · Protected area height · 1360 mm · for type OY · Housing materials: aluminium epoxy-powder coated / plastics / Accessories: steel galvanised	EY1009
	Corner mirror · Length: 1600 mm · for safety light curtains · Protected area height · 1510 mm · for type OY · Housing materials: aluminium epoxy-powder coated / plastics / Accessories: steel galvanised	EY1010
	Vibration damper · for type OY · Housing materials: rubber / metal galvanised	EY3001
	Vibration damper · for type OY · Housing materials: rubber / metal galvanised	EY3002

Type	Description	Order no.
	Rotatable brackets · axial $\pm 90^\circ$ · for type OY · Housing materials: Angle bracket: steel black	EY3011
	Adjustable brackets · axial $\pm 7^\circ$ · for type OY · Housing materials: metal galvanised	EY3004
	Adjustable brackets · axial $\pm 7^\circ$ · for type OY · Housing materials: metal galvanised	EY3005
	Test rod · $\varnothing 14$ mm · Probe length: 150 mm · for safety light curtains · for type OY · Housing materials: aluminium	EY3006
	Test rod · $\varnothing 20$ mm · Probe length: 150 mm · for safety light curtains · for type OY · Housing materials: aluminium	EY3007
	Test rod · $\varnothing 30$ mm · Probe length: 150 mm · for safety light curtains · for type OY · Housing materials: aluminium	EY3008
	Test rod · $\varnothing 40$ mm · Probe length: 150 mm · for safety light curtains · for type OY · Housing materials: aluminium	EY3009
	Test rod · $\varnothing 50$ mm · Probe length: 150 mm · for safety light curtains · for type OY · Housing materials: aluminium	EY3010
	Adapter cable · straight · For the connection of safety light curtains / safety light grids with OSSD · for receiver · Configured for automatic operation · Free from silicone · Free from halogen · Gold-plated contacts · 0.1 m · Housing materials: TPU orange / PA	EY3090
	Adapter cable · straight · For the connection of safety light curtains / safety light grids with OSSD · for transmitter · Configured for "long range" · Free from silicone · Free from halogen · Gold-plated contacts · 0.1 m · Housing materials: TPU orange / PA	EY3091
	Adapter cable · straight · For the connection of safety light curtains / safety light grids with OSSD · for transmitter · Configured for "short range" · Free from silicone · Free from halogen · Gold-plated contacts · 0.1 m · Housing materials: TPU orange / PA	EY3092
	Laser adjustment aid · for type OY9xxS · for safety light grids · Housing materials: plastics	EY3098
	Laser adjustment aid · for safety light curtains · for type OY · Housing materials: plastics	EY3099

Bases for safety light curtains

Type	Description	Order no.
	Base · Length: 1010 mm · for safety light grids · 2 beams · for safety light curtains · ≤ 760 mm · for type OY · Housing materials: aluminium epoxy-powder coated / plastics	EY2001

Type	Description	Order no.
	Base · Length: 1340 mm · for safety light grids · 3 beams · 4 beams · for safety light curtains · ≤ 1060 mm · for type OY · Housing materials: aluminium epoxy-powder coated / plastics	EY2002
	Base · Length: 1710 mm · for safety light curtains · ≤1360 mm · for type OY · Housing materials: aluminium epoxy-powder coated / plastics	EY2003
	Base · Length: 1980 mm · for safety light curtains · ≤ 1510 mm · for type OY · Housing materials: aluminium epoxy-powder coated / plastics	EY2004

Bases for safety light curtains with corner mirror

Type	Description	Order no.
	Corner mirror with base · Length: 1010 mm · for safety light grids · 2 beams · for safety light curtains · ≤ 760 mm · for type OY · Housing materials: aluminium epoxy-powder coated / plastics	EY1011
	Corner mirror with base · Length: 1340 mm · for safety light grids · 3 beams · 4 beams · for safety light curtains · ≤ 1060 mm · for type OY · Housing materials: aluminium epoxy-powder coated / plastics	EY1013
	Corner mirror with base · Length: 1710 mm · for safety light curtains · ≤1360 mm · for type OY · Housing materials: aluminium epoxy-powder coated / plastics	EY1014
	Corner mirror with base · Length: 1980 mm · for safety light curtains · ≤ 1510 mm · for type OY · Housing materials: aluminium epoxy-powder coated / plastics	EY1015

Accessories necessary for bases

Type	Description	Order no.
	Mounting base · for type OY	EY2005

Wiring diagrams

Core colours

BK	black
BN	brown
BU	blue
GN	green
GY	grey
PK	pink
RD	red
VT	lilac
WH	white
YE	yellow

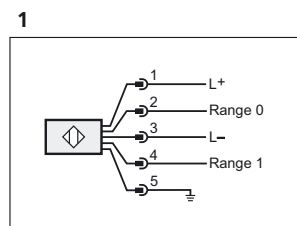

Wiring diagrams

2

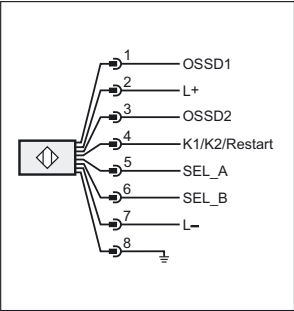

3

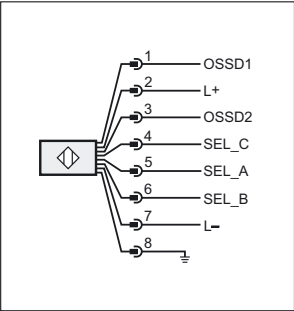

4

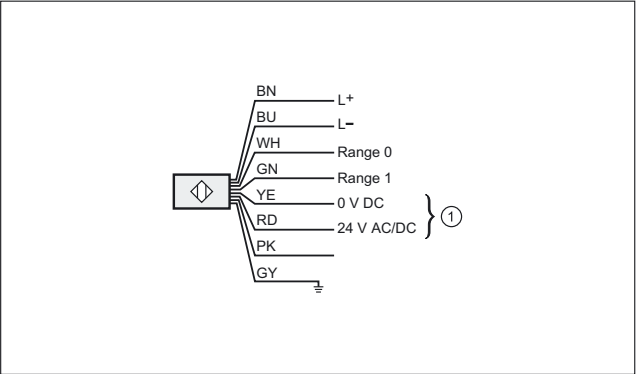

1: Heating, pink: not used

5

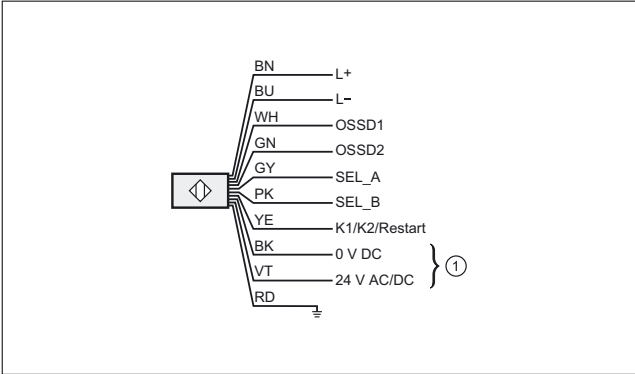

1: Heating

Scale drawings / drawing no. – CAD download: www.ifm.com

1

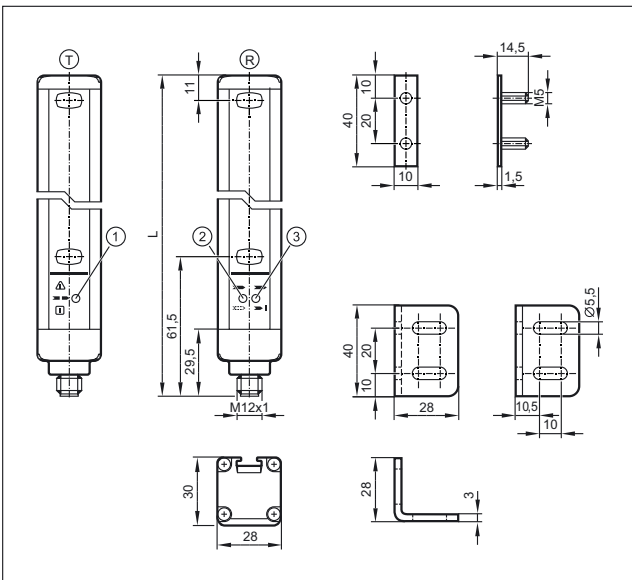

T: Transmitter, R: Receiver, 1: LED 3 colours (red/green/orange),
2: LED 2 colours (yellow/blue), 3: LED 2 colours (red/green)

2

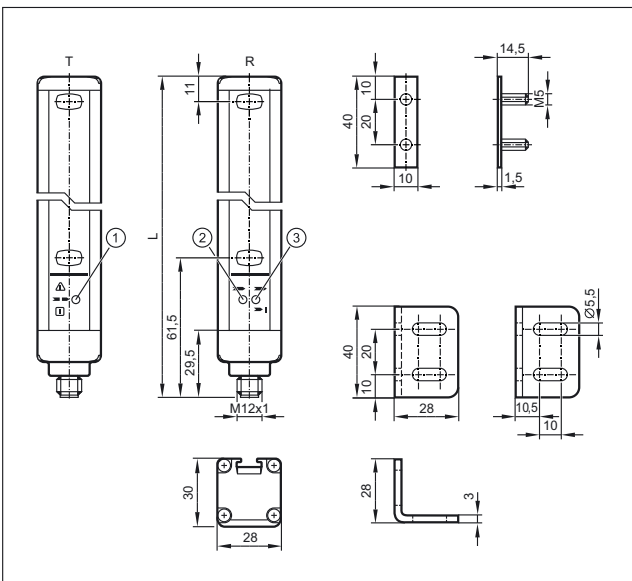

T: Transmitter, R: Receiver, 1: LED 3 colours (red/green/orange),
2: LED (yellow), 3: LED 2 colours (red/green)

3

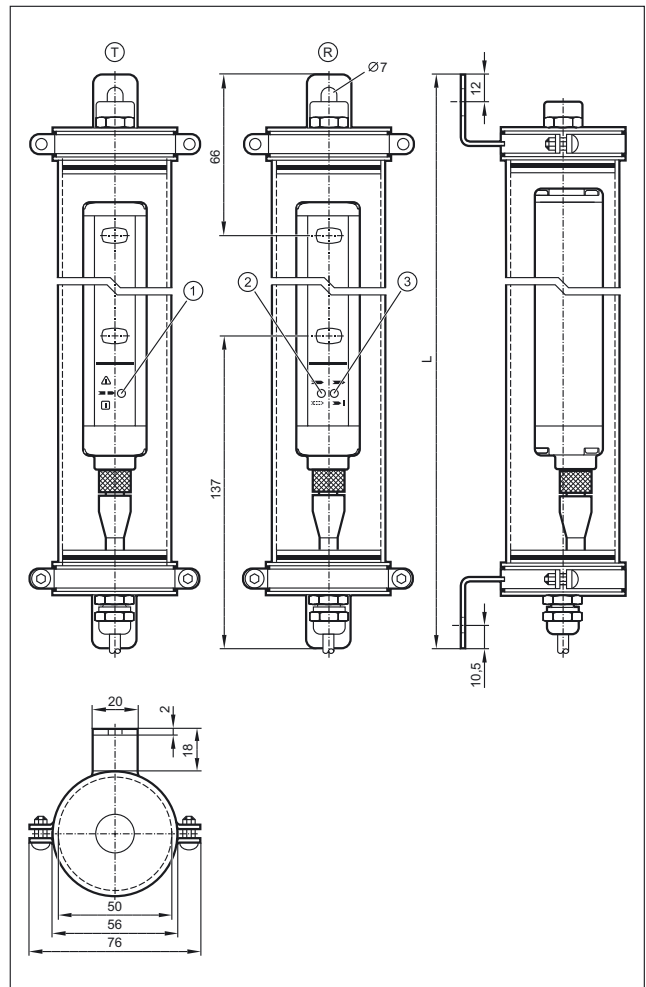

T: Transmitter, R: Receiver, 1: LED 3 colours (red/green/orange),
2: LED 2 colours (yellow/blue), 3: LED 2 colours (red/green)

Scale drawings / drawing no. – CAD download: www.ifm.com

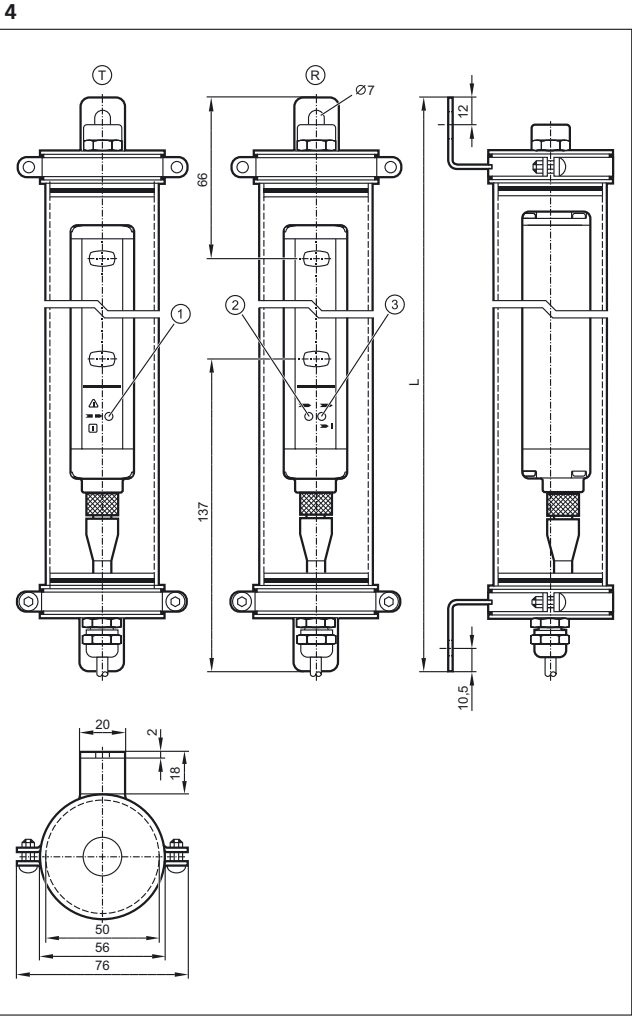

T: Transmitter, R: Receiver, 1: LED 3 colours (red/green/orange), 2: LED 2 colours (yellow/blue), 3: LED 2 colours (red/green)

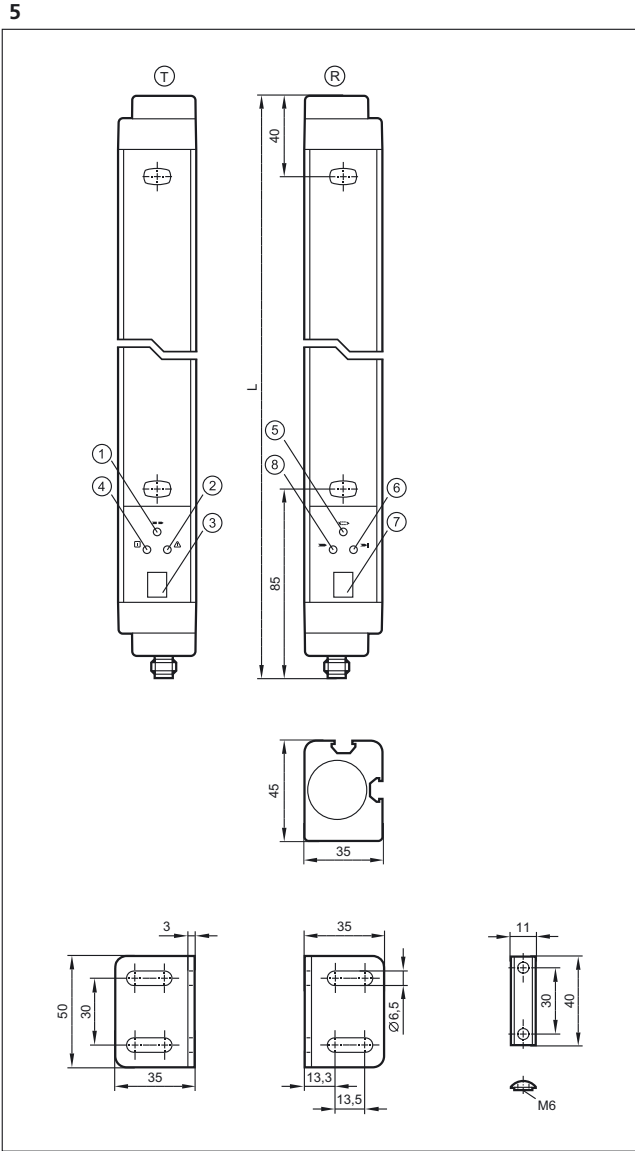

T: Transmitter, R: Receiver, 1: LED yellow, 2: LED red, 3: 7-segment LED display, 4: LED green, 5: LED yellow, 6: LED red, 7: 7-segment LCD display, 8: LED green



Safety light grids

Wherever motion of machine parts presents a danger to people or goods, safety light curtains or safety light grids are used.

The protective equipment ensures that the outputs are switched off which results in a machine halt.

System overview	Page
Safety light grids type 2, SIL 1, PL c, 2, 3, 4 beams, protected area width up to 10 m	414
Safety light grids type 4, SIL 3, PL e, 2, 3, 4 beams, protected area width up to 12 m	415
Safety light grids type 4, SIL 3, PL e, 2, 3, 4 beams, protected area width up to 20 m	415
Safety light grids for hygienic and wet areas type 4, SIL 3, PL e, 2, 3, 4 beams, protected area width up to 15 m	415
Safety light grids type 4, SIL 3, PL e, 2, 3, 4 beams, protected area width up to 60 m	416
Safety light grids with active / passive system type 4, SIL 3, PL e, 2, 3, 4 beams, protected area width up to 6 m	416
Safety light grids for hygienic and wet areas type 2, SIL 1, PL c, 2, 3, 4 beams, protected area width up to 10 m	416
Accessories for safety light grids	417
Bases for safety light grids	418
Bases for safety light grids with corner mirror	418
Accessories necessary for bases	418
Wiring diagrams	418 - 419
Scale drawings / drawing no. – CAD download: www.ifm.com	419 - 421

Safety light grids type 2, SIL 1, PL c, 2, 3, 4 beams, protected area width up to 10 m

Type	Dimensions [mm]	Number of beams	Protected area height [mm]	Protected area width [m]	Response time [ms]	U _b [V]	Draw- ing no.	Order no.
------	--------------------	--------------------	----------------------------------	--------------------------------	--------------------------	-----------------------	---------------------	--------------

M12 connector · Wiring diagram no. 1, 2 · Connector groups 16, 17

	L x 28 x 30	2	510	0...4 / 3...12	3	24	1	OY111S
	L x 28 x 30	3	810	0...4 / 3...12	3.5	24	1	OY112S
	L x 28 x 30	4	910	0...4 / 3...12	3.5	24	1	OY113S

Safety light grids type 4, SIL 3, PL e, 2, 3, 4 beams, protected area width up to 12 m

Type	Dimensions [mm]	Number of beams	Protected area height [mm]	Protected area width [m]	Response time [ms]	U _b [V]	Drawing no.	Order no.
------	--------------------	-----------------	-------------------------------	-----------------------------	-----------------------	-----------------------	-------------	-----------

M12 connector · Wiring diagram no. 1, 2 · Connector groups 16, 17

	L x 28 x 30	2	510	0...4 / 3...12	2.5	24	1	OY1145
	L x 28 x 30	3	810	0...4 / 3...12	3	24	1	OY1155
	L x 28 x 30	4	910	0...4 / 3...12	3	24	1	OY1165

Safety light grids type 4, SIL 3, PL e, 2, 3, 4 beams, protected area width up to 20 m

Type	Dimensions [mm]	Number of beams	Protected area height [mm]	Protected area width [m]	Response time [ms]	U _b [V]	Drawing no.	Order no.
------	--------------------	-----------------	-------------------------------	-----------------------------	-----------------------	-----------------------	-------------	-----------

M12 connector · Wiring diagram no. 1, 2 · Connector groups 16, 17

	L x 28 x 30	2	510	0...10 / 3...20	2.5	24	1	OY1205
	L x 28 x 30	3	810	0...10 / 3...20	2.5	24	1	OY1215
	L x 28 x 30	4	910	0...10 / 3...20	2.5	24	1	OY1225

Safety light grids for hygienic and wet areas type 4, SIL 3, PL e, 2, 3, 4 beams, protected area width up to 15 m

Type	Dimensions [mm]	Number of beams	Protected area height [mm]	Protected area width [m]	Response time [ms]	U _b [V]	Drawing no.	Order no.
------	--------------------	-----------------	-------------------------------	-----------------------------	-----------------------	-----------------------	-------------	-----------

Cable 15 m · Wiring diagram no. 3, 4

	L x 76 x 74	2	510	0...7 / 3...15	2.5	24	2	OY4215
	L x 76 x 74	3	810	0...7 / 3...15	2.5	24	2	OY4225
	L x 76 x 74	4	910	0...7 / 3...15	2.5	24	2	OY4235

Safety light grids type 4, SIL 3, PL e, 2, 3, 4 beams, protected area width up to 60 m

Type	Dimensions [mm]	Number of beams	Protected area height [mm]	Protected area width [m]	Response time [ms]	U _b [V]	Drawing no.	Order no.
------	--------------------	-----------------	-------------------------------	-----------------------------	-----------------------	-----------------------	-------------	-----------

M12 connector · Wiring diagram no. 1, 2 · Connector groups 16, 17

	L x 50 x 60	2	510	8...30 / 18...60	7	24	3	OY951S
	L x 50 x 60	3	810	8...30 / 18...60	7	24	3	OY952S
	L x 50 x 60	4	910	8...30 / 18...60	7	24	3	OY953S

Safety light grids with active / passive system type 4, SIL 3, PL e, 2, 3, 4 beams, protected area width up to 6 m

Type	Dimensions [mm]	Number of beams	Protected area height [mm]	Protected area width [m]	Response time [ms]	U _b [V]	Drawing no.	Order no.
------	--------------------	-----------------	-------------------------------	-----------------------------	-----------------------	-----------------------	-------------	-----------

M12 connector · Wiring diagram no. 2 · Connector groups 16, 17

	L x 50 x 60	2	510	0...6 / 0...6	10	24	4	OY901S
	L x 50 x 60	3	810	0...6 / 0...6	10.5	24	4	OY902S
	L x 50 x 60	4	910	0...6 / 0...6	10.5	24	4	OY903S













Safety light grids for hygienic and wet areas type 2, SIL 1, PL c, 2, 3, 4 beams, protected area width up to 10 m

Type	Dimensions [mm]	Number of beams	Protected area height [mm]	Protected area width [m]	Response time [ms]	U _b [V]	Drawing no.	Order no.
------	--------------------	-----------------	-------------------------------	-----------------------------	-----------------------	-----------------------	-------------	-----------

Cable 15 m · Wiring diagram no. 3, 4

	L x 76 x 74	2	510	0...3 / 2...10	3	24	5	OY411S
	L x 76 x 74	3	810	0...3 / 2...10	3.5	24	5	OY412S
	L x 76 x 74	4	910	0...3 / 2...10	3.5	24	5	OY413S

Accessories for safety light grids

Type	Description	Order no.
	Corner mirror · Length: 715 mm · for safety light curtains · Protected area height · 610 mm · for safety light grids · 2 beams · for type OY · Housing materials: aluminium epoxy-powder coated / plastics / Accessories: steel galvanised	EY1004
	Corner mirror · Length: 1060 mm · for safety light curtains · Protected area height · 910 mm · for safety light grids · 3 beams · for type OY · Housing materials: aluminium epoxy-powder coated / plastics / Accessories: steel galvanised	EY1006
	Corner mirror · Length: 1230 mm · for safety light curtains · Protected area height · 1060 mm · for safety light grids · 4 beams · for type OY · Housing materials: aluminium epoxy-powder coated / plastics / Accessories: steel galvanised	EY1007
	Vibration damper · for type OY · Housing materials: rubber / metal galvanised	EY3001
	Vibration damper · for type OY · Housing materials: rubber / metal galvanised	EY3002
	Rotatable brackets · axial $\pm 90^\circ$ · for type OY · Housing materials: Angle bracket: steel black	EY3011
	Adjustable brackets · axial $\pm 7^\circ$ · for type OY · Housing materials: metal galvanised	EY3004
	Adjustable brackets · axial $\pm 7^\circ$ · for type OY · Housing materials: metal galvanised	EY3005
	Adapter cable · straight · For the connection of safety light curtains / safety light grids with OSSD · for receiver · Configured for automatic operation · Free from silicone · Free from halogen · Gold-plated contacts · 0.1 m · Housing materials: TPU orange / PA	EY3090
	Adapter cable · straight · For the connection of safety light curtains / safety light grids with OSSD · for transmitter · Configured for "long range" · Free from silicone · Free from halogen · Gold-plated contacts · 0.1 m · Housing materials: TPU orange / PA	EY3091
	Adapter cable · straight · For the connection of safety light curtains / safety light grids with OSSD · for transmitter · Configured for "short range" · Free from silicone · Free from halogen · Gold-plated contacts · 0.1 m · Housing materials: TPU orange / PA	EY3092
	Laser adjustment aid · for type OY9xxS · for safety light grids · Housing materials: plastics	EY3098
	Laser adjustment aid · for safety light curtains · for type OY · Housing materials: plastics	EY3099

Bases for safety light grids

Type	Description	Order no.
	Base · Length: 1010 mm · for safety light grids · 2 beams · for safety light curtains · ≤ 760 mm · for type OY · Housing materials: aluminium epoxy-powder coated / plastics	EY2001
	Base · Length: 1340 mm · for safety light grids · 3 beams · 4 beams · for safety light curtains · ≤ 1060 mm · for type OY · Housing materials: aluminium epoxy-powder coated / plastics	EY2002

Bases for safety light grids with corner mirror

Type	Description	Order no.
	Corner mirror with base · Length: 1010 mm · for safety light grids · 2 beams · for safety light curtains · ≤ 760 mm · for type OY · Housing materials: aluminium epoxy-powder coated / plastics	EY1011
	Corner mirror with base · Length: 1340 mm · for safety light grids · 3 beams · 4 beams · for safety light curtains · ≤ 1060 mm · for type OY · Housing materials: aluminium epoxy-powder coated / plastics	EY1013

Accessories necessary for bases

Type	Description	Order no.
	Mounting base · for type OY	EY2005

Wiring diagrams

Core colours

BK	black
BN	brown
BU	blue
GN	green
GY	grey
PK	pink
RD	red
VT	lilac
WH	white
YE	yellow

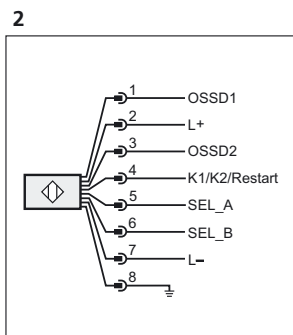
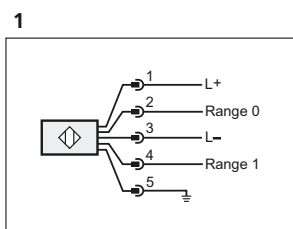

Wiring diagrams

3

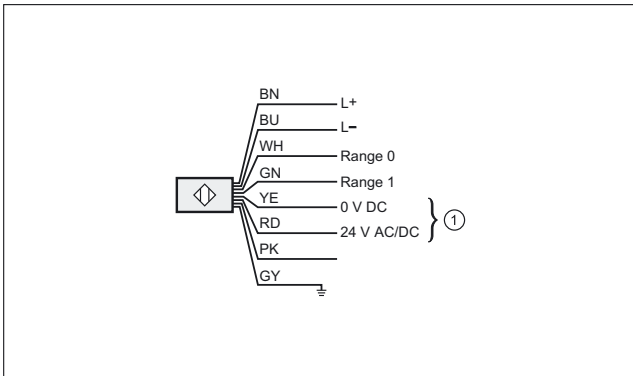

1: Heating, pink: not used

4

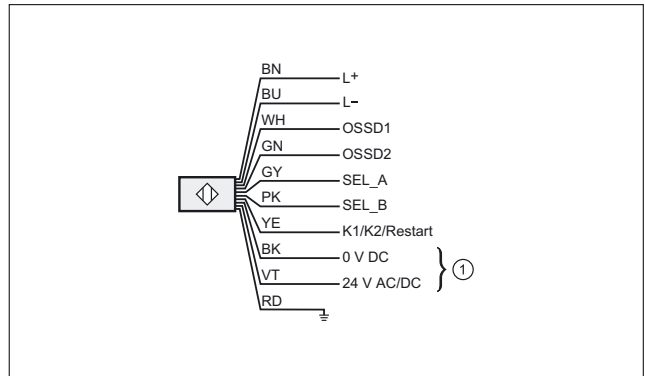

1: Heating

Scale drawings / drawing no. – CAD download: www.ifm.com

1

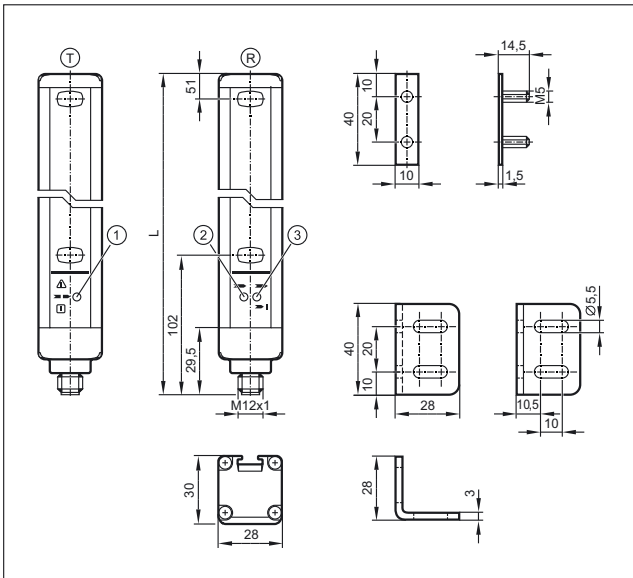

T: Transmitter, R: Receiver, 1: LED 3 colours (red/green/orange), 2: LED yellow, 3: LED 2 colours (red/green)

2

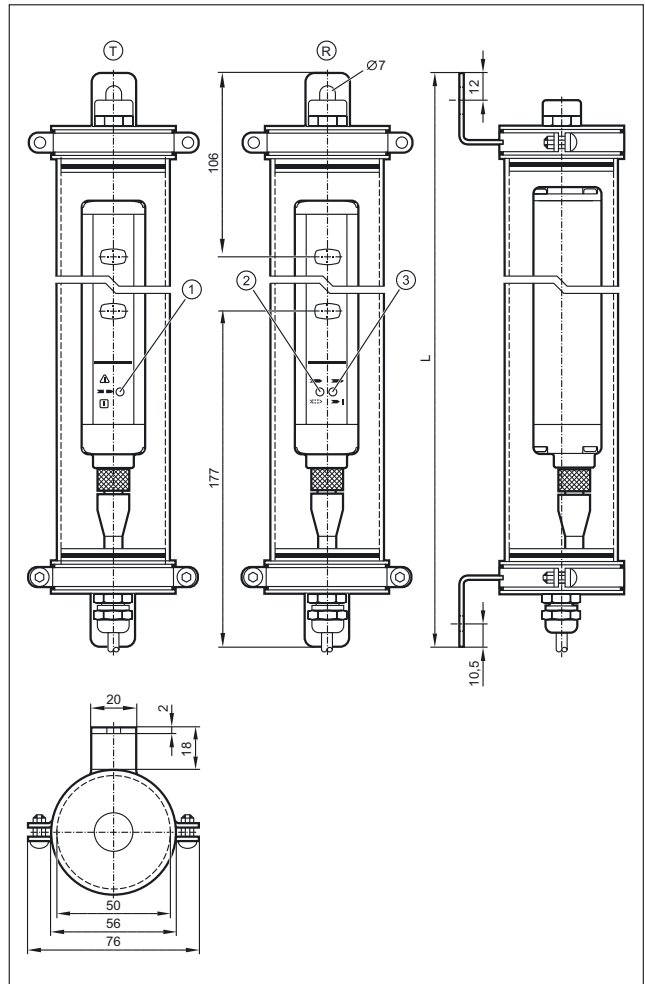

T: Transmitter, R: Receiver, 1: LED 3 colours (red/green/orange), 2: LED 2 colours (yellow/blue), 3: LED 2 colours (red/green)

3

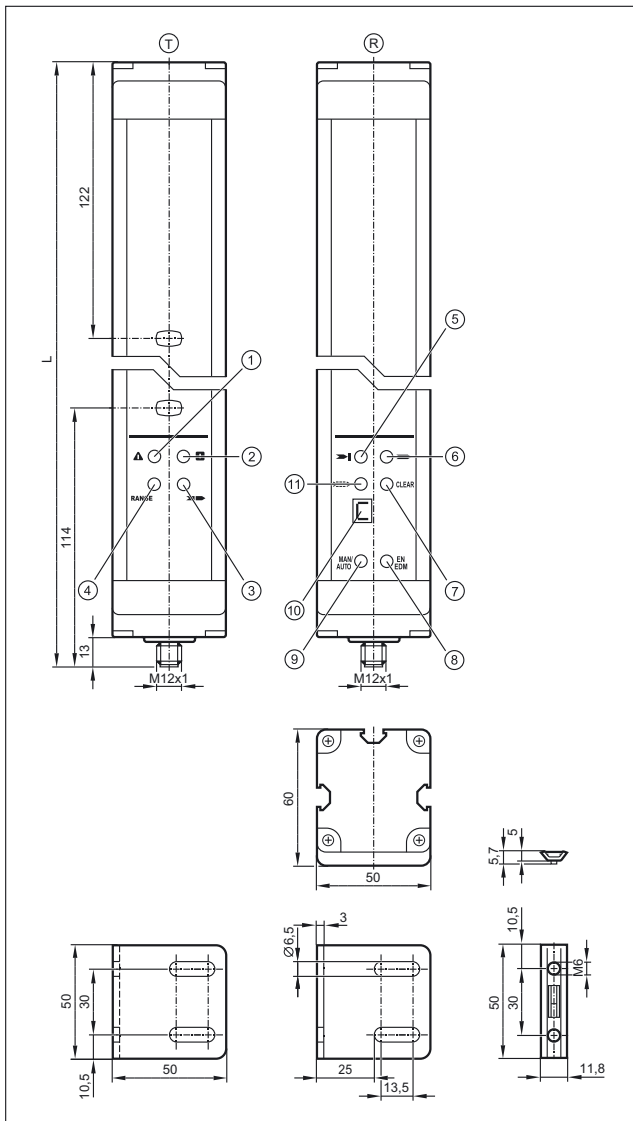

T: Transmitter, R: Receiver, 1: LED (red), 2: LED (green), 3: LED (yellow), 4: LED (orange), 5: LED (red), 6: LED (green), 7: LED (yellow), 8: LED (yellow), 9: LED (yellow), 10: display, 11: LED (orange)

4

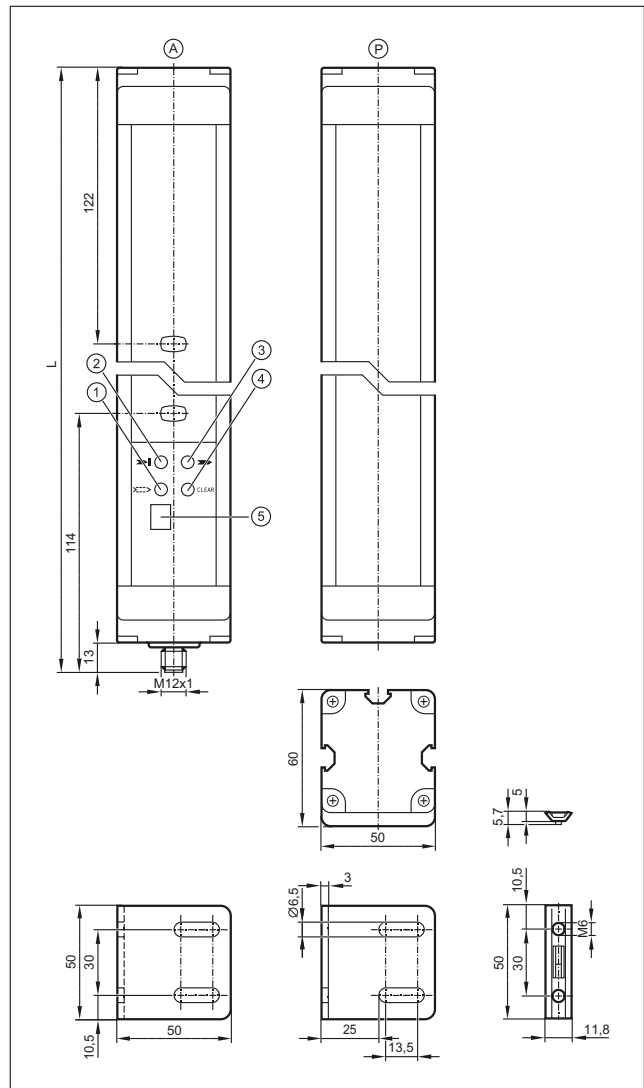

A: active element, P: passive element, 1: LED (orange), 2: LED (red), 3: LED (green), 4: LED (yellow), 5: display

Scale drawings / drawing no. – CAD download: www.ifm.com

5

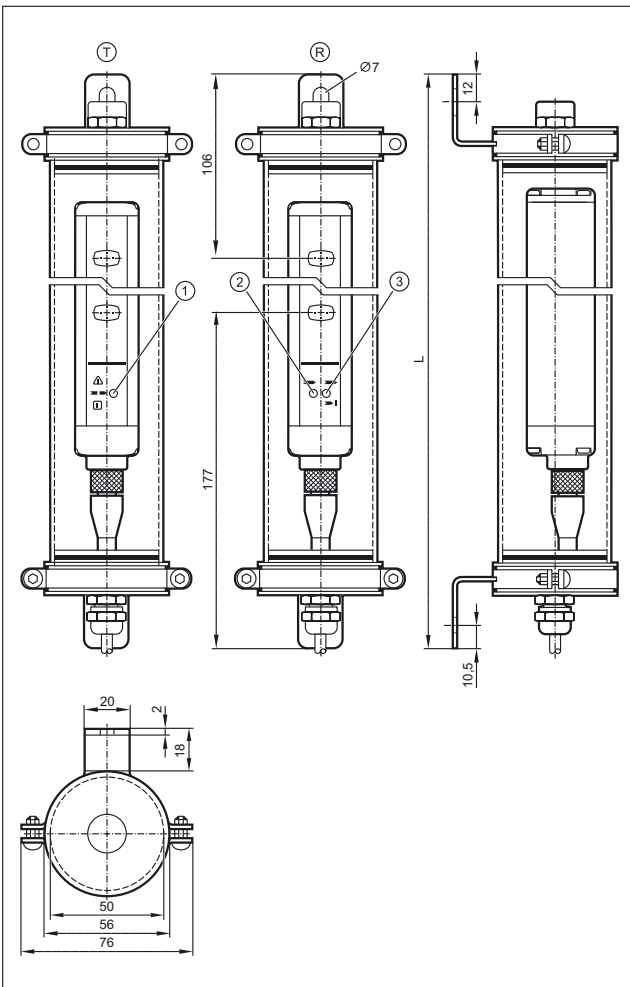

T: Transmitter, R: Receiver, 1: LED 3 colours (red/green/orange),
 2: LED 2 colours (yellow/blue), 3: LED 2 colours (red/green)





Safety relays

Multifunctional with the advantage on your side: The safety relays provide various connection options for safety light curtains, fail-safe inductive sensors or other non-contact guards. They meet the highest requirement with SIL 3 (IEC 61508). "Monitored" or "automatic start" as well as external muting are only some of numerous functions.

System overview	Page
Safety relays with relay outputs for fail-safe sensors	422
Safety relays with solid state outputs for fail-safe sensors	422
Safety relays for safety light curtains	423
Safety standstill monitors, SIL 3, PL e	423
Accessories	423
Scale drawings / drawing no. – CAD download: www.ifm.com	423 - 424

Safety relays with relay outputs for fail-safe sensors

Type	U _b [V]	Electrical design	ISO 13849-1: Category / performance level	IEC 61508: SIL	Drawing no.	Order no.
	24	Relay	4 / e	3	1	G1501S
	24	Relay	4 / e	3	2	G1502S

Safety relays with solid state outputs for fail-safe sensors

Type	U _b [V]	Electrical design	ISO 13849-1: Category / performance level	IEC 61508: SIL	Drawing no.	Order no.
	24	Semi-conductor outputs	4 / e	3	3	G1503S

Safety relays for safety light curtains

Type	U _b [V]	Electrical design	ISO 13849-1: Category / performance level	IEC 61508: SIL	Draw- ing no.	Order no.
	24	Relay	4 / e	3	4	G2001S

Safety standstill monitors, SIL 3, PL e

Type	U _b [V]	In- puts	Input function	Setting range [puls. / min.]	Setting range [Hz]	Out- puts analogue	Out- puts relays	Out- puts transist.	Draw- ing no.	Order no.
	24 DC	1	PNP	–	0.2 / 0.5 / 1.0 / 2.0	–	2	1	1	DA101S

Monitoring rotational or linear movements for minimum switch point not reached (standstill)

Accessories

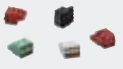
Type	Description	Order no.
	Combicon connector · with cage clamps 4 poles · Housing materials: PA / current carrying parts: copper alloy tin-plated	E11930

Scale drawings / drawing no. – CAD download: www.ifm.com

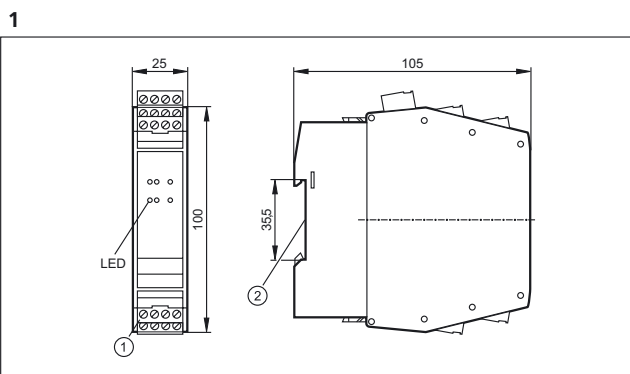

1: Combicon connector with screw terminals, 2: Mounting on DIN rail

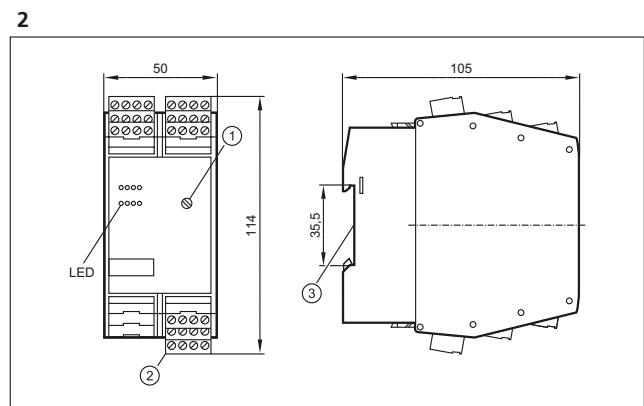

1: Rotary switch for switch-off delay, 2: Combicon connector with screw terminals, 3: Mounting on DIN rail

Scale drawings / drawing no. – CAD download: www.ifm.com

3

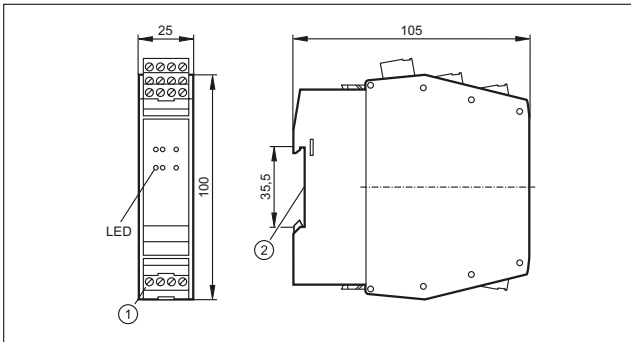

1: Combicon connector with screw terminals, 2: Mounting on DIN rail

4

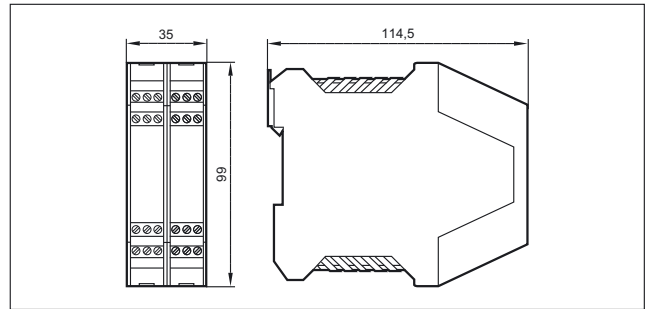







Safety controllers



Controllers for safety-related applications up to safety category 3 (EN 954-1) are called "safety controllers". Special test routines for hardware and software monitoring are implemented in the devices. Due to the certification of the hardware, operating system software and programming tools it is easy for the project engineer to get the approval for the machine.



System overview	Page
16-bit SafetyController	426
Accessories and software	426 - 427
Scale drawings / drawing no. – CAD download: www.ifm.com	427

16-bit SafetyController

Type	Inputs / outputs	Description	Drawing no.	Order no.
	24	SafetyController · 16 Bit · Programmable mobile controller type R 360 · for safety applications · SILcl 2 (IEC 62061) · PL d (EN ISO 13849-1) · 2 nd CAN interface for gateway function according to SAE J 1939 · Configurable input / output functions · Programming according to IEC 61131-3 · 24 inputs/outputs · 10...32 V DC	1	CR7506
	40	SafetyController · 16 Bit · Programmable mobile controller type R 360 · for safety applications · SILcl 2 (IEC 62061) · PL d (EN ISO 13849-1) · 2 nd CAN interface for gateway function according to SAE J 1939 · Configurable input / output functions · Programming according to IEC 61131-3 · 40 inputs/outputs · 10...32 V DC	1	CR7021
	80	SafetyController · 16 Bit · Programmable mobile controller type R 360 · for safety applications · SILcl 2 (IEC 62061) · PL d (EN ISO 13849-1) · 2 nd CAN interface for gateway function according to SAE J 1939 · Configurable input / output functions · Programming according to IEC 61131-3 · 80 inputs/outputs · 10...32 V DC	2	CR7201

Accessories and software

Type	Description	Order no.
	Programming software CODESYS · for configuration, programming and diagnosis of ifm controller systems · German version · incl. the DVD "Software, tools and documentation"	CP9006
	Programming software CODESYS · for configuration, programming and diagnosis of ifm controller systems · English version · incl. the DVD "Software, tools and documentation"	CP9008
	Connector AMP 55-pole · wirable · with contacts (Junior Power Timer)	EC2013

Type	Description	Order no.
	Cable with connector · AMP 55-pole · wired · Cable length 1.2 m · Cores sealed individually · Core cross-section 1 mm ²	EC2084
	Cable with connector · AMP 55-pole · wired · Cable length 2.5 m · Cores sealed individually · Core cross-section 1 mm ²	EC2097
	Cable with connector · AMP 55-pole · wired · Cable length 1.2 m · Core cross-section 1 mm ²	EC2086
	Cable with connector · AMP 55-pole · wired · Cable length 2.5 m · Core cross-section 1 mm ²	EC2046

Scale drawings / drawing no. – CAD download: www.ifm.com

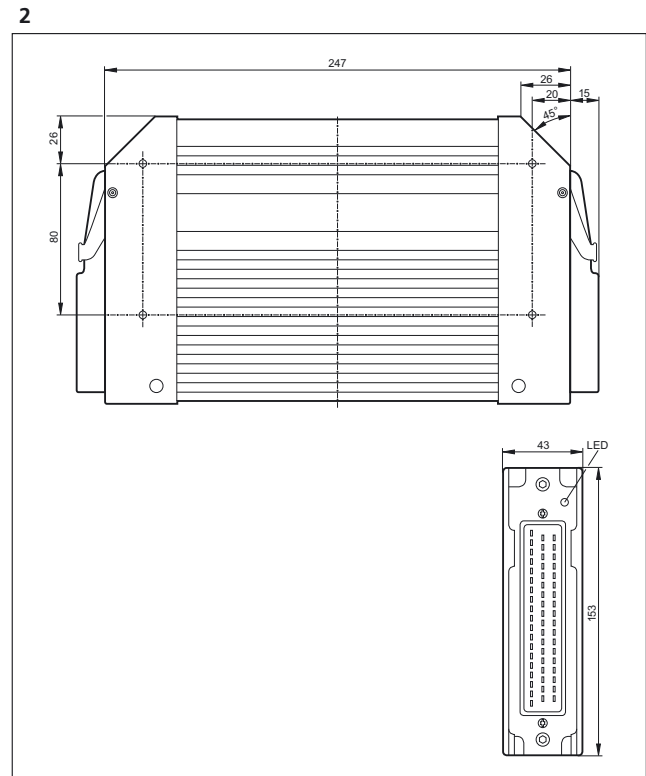
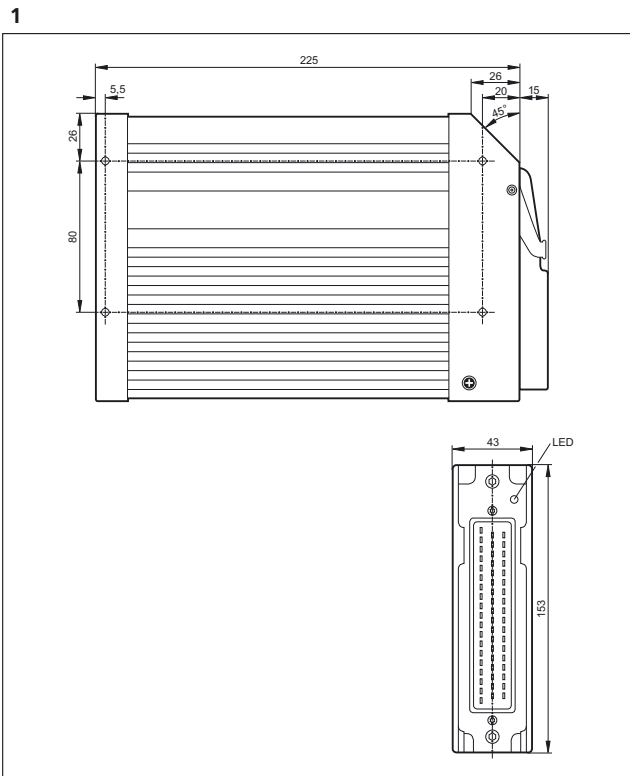







AS-Interface Safety at Work

The sophisticated AS-i technology and the extended diagnostic possibilities provide high reliability and machine uptime. "Safety at Work" is the extension of the AS-interface by safety-related components. Safety components up to the highest control category 4 to EN 954-1, SIL 3 to IEC 61508 and EN ISO 13849 - 1 / PL e can be connected to AS-i.

System overview	Page
Safety at Work	428 - 430
Accessories Safety at Work	430
AS-i manuals	431
Scale drawings / drawing no. – CAD download: www.ifm.com	431 - 433

Safety at Work

Type	Description	Drawing no.	Order no.
	AS-i safety monitor · Basic version · 1-channel · Configuration and setup by configuration software ASIMON · Screw terminal · polyamide black · Complies with the requirements: ISO 13849-1: PL e · IEC 61508: SIL 3	1	AC001S
	AS-i safety monitor · Basic version · 2-channel · Configuration and setup by configuration software ASIMON · Screw terminal · polyamide black · Complies with the requirements: ISO 13849-1: PL e · IEC 61508: SIL 3	1	AC002S
	AS-i safety monitor · Extended functionality · 1-channel · Configuration and setup by configuration software ASIMON · Screw terminal · polyamide black · Complies with the requirements: ISO 13849-1: PL e · IEC 61508: SIL 3	1	AC003S
	AS-i safety monitor · Extended functionality · 2-channel · Configuration and setup by configuration software ASIMON · Screw terminal · polyamide black · Complies with the requirements: ISO 13849-1: PL e · IEC 61508: SIL 3	1	AC004S
	AS-i safety monitor · Extended functionality and integrated safe slave for triggering a safe AS-i output · 2-channel · Configuration and setup by configuration software ASIMON V3.0 · Screw terminal · polyamide black · Complies with the requirements: ISO 13849-1: category 4 · ISO 13849-1: PL e · IEC 61508: SIL 3	2	AC032S
	AS-i safety monitor · 2 safe semi-conductor outputs · SIL 3 to EN 62061, IEC 61508 / SIL 3 and EN ISO 13849 - 1 / PL e · Chip card to save the configuration data · Configuration and setup by configuration software ASIMON V3 G2 · USB 2.0 interface · Chip card and Combicon screw terminals supplied with the device · Screw terminal	3	AC041S
	Safe active AS-i module · Performance Level e to EN ISO 13849-1 et IEC 61508 / SIL 3 for the connection of mechanical contacts · Combicon connection · PA · Complies with the requirements: ISO 13849-1: category 4 · ISO 13849-1: PL e · IEC 61508: SIL 3	4	AC009S
	Safe active AS-i output module · SIL 3 to EN 62061, IEC 61508 / SIL 3 and EN ISO 13849 - 1 / PL e · for the safe triggering of actuators · Combicon connection · PA · Complies with the requirements: ISO 13849-1: PL e · IEC 61508: SIL 3	5	AC030S
	Safe active AS-i module · Connection via M12x1 sockets or cage clamps · For connection of an electro-sensitive protective equipment (ESPE) type 4 to EN 61496-1 · PA 6 · Complies with the requirements: ISO 13849-1: category 4 · ISO 13849-1: PL e · IEC 61508: SIL 3	6	AC007S

Type	Description	Draw- ing no.	Order no.
	AS-i Safety at Work · Safe AS-i input module 2SI - 2LO · Addressing socket · Three orientations of the flat cable are possible · Sockets M12 x 1 · PA / Piercing contacts: CuSn6 surface nickel and tin-plated · Complies with the requirements: ISO 13849-1: category 4 · ISO 13849-1: PL e · IEC 62061: SILcl 3	7	AC505S
	AS-i Safety at Work · Safe AS-i input module 4SI / 2DO T / 2LO · Addressing socket · Three orientations of the flat cable are possible · Sockets M12 x 1 · PA / Piercing contacts: CuSn6 surface nickel and tin-plated · Complies with the requirements: ISO 13849-1: PL d · IEC 62061: SILcl 2	7	AC506S
	Safe active AS-i ClassicLine module · IR addressing possible · Performance Level e to EN ISO 13849-1 for the connection of mechanical contacts · Sockets M12 x 1 · PBT · Complies with the requirements: ISO 13849-1: category 4 · ISO 13849-1: PL e · IEC 61508: SIL 3	8	AC006S
	Illuminated E-STOP · front mounting · reset by turning · 2 NC contacts / 1 red LED · fool-proof E-STOP to EN ISO 13850	9	E7007S
	Illuminated E-STOP with integrated AS-i connection · fool-proof E-STOP to EN ISO 13850 · Pull to reset · AS-i interface via AS-i flat cable IP 67 · PC GF20 · Complies with the requirements: ISO 13849-1: category 4 · ISO 13849-1: PL e · IEC 61508: SIL 3	10	AC010S
	Key-release E-STOP with integrated AS-i connection · Connector M12 x 1 · AS-i interface via AS-i flat cable IP 67 · fool-proof E-STOP to EN ISO 13850 · Reset by key operation · PC GF20 · Complies with the requirements: ISO 13849-1: PL e · IEC 61508: SIL 3	11	AC011S
	safe AS-i e-stop operating unit with integrated AS-i connection · AS-i interface via M12 x 1 connector · fool-proof E-STOP to EN ISO 13850 · Pull to reset · interchangeable button inserts	12	AC012S
	Safe active AS-i ClassicLine module · AS-i version 2.1 · IR addressing possible · Control category 4 according to EN954-1 · For the connection of fail-safe inductive sensors of the control category 4 · Sockets M12 x 1 · PBT · Complies with the requirements: ISO 13849-1: category 4 · ISO 13849-1: PL e · IEC 61508: SIL 3	-	AC016S
	AS-i safety PCB · Connection of mechanical contact and LED components · Certification to ISO 13849-1: PL e and IEC 61508 / SIL 3 · Complies with the requirements: · IEC 61508: SIL 3	13	AC015S
	Fail-safe inductive sensor · M12 connector, Gold-plated contacts · PPE / diecast zinc · Complies with the requirements: ISO 13849-1: category 4 · ISO 13849-1: PL e · IEC 61508: SIL 3	14	GM504S
	Fail-safe inductive sensor · M12 connector, Gold-plated contacts · PPE / diecast zinc · Complies with the requirements: ISO 13849-1: category 4 · ISO 13849-1: PL e · IEC 61508: SIL 3	14	GM505S
	Fail-safe inductive sensor · M18 x 1 · M12 connector, Gold-plated contacts · high-grade stainless steel / PBT · Complies with the requirements: ISO 13849-1: category 4 · ISO 13849-1: PL e · IEC 61508: SIL 3	15	GG505S
	Fail-safe inductive sensor · M30 x 1.5 · M12 connector, Gold-plated contacts · PEEK / high-grade stainless steel / O-ring: EPDM · Complies with the requirements: ISO 13849-1: category 4 · ISO 13849-1: PL e · IEC 61508: SIL 3	16	GI505S
	Safety switch with guard locking · Normally closed principle · Rotatable actuating head made of metal · Mechanical release on the front · Supply via AS-i / solenoid supply ext. from 24 V DC · M12 connector · thermoplastic reinforced glass-fibre	17	AC901S
	Safety switch with guard locking · Normally open principle · Rotatable actuating head made of metal · Mechanical release on the front · Supply via AS-i / solenoid supply ext. from 24 V DC · M12 connector · thermoplastic reinforced glass-fibre	17	AC902S
	Safety switch with guard locking · Normally closed principle · Rotatable actuating head made of metal · Mechanical release on the front · Supply via AS-i / solenoid supply from AS-i · M12 connector · thermoplastic reinforced glass-fibre	18	AC903S

Type	Description	Draw- ing no.	Order no.
	Safety switch with guard locking · Normally open principle · Rotatable actuating head made of metal · Mechanical release on the front · Supply via AS-i / solenoid supply from AS-i · M12 connector · thermoplastic reinforced glass-fibre	18	AC904S

Accessories Safety at Work

Type	Description	Order no.
	AS-i Safety at Work · Programming software for AS-i safety monitor AC001S / AC002S / AC003S / AC004S / AC032S · Version 3.0 · Configuration, set-up and diagnostics of the AS-i safety monitor	E7040S
	Software ASIMON V3 G2 · Configuration, set-up and diagnostics of the AS-i safety monitor · AC041S	E7050S
	USB interface cable for the connection of the safety monitor AC041S to the PC · cable length 1.8 m · 1.8 m	E7051S
	Chip card to save the configuration data of the AS-i safety monitor AC041S · 256 K	E7052S
	Safe contact expander without delay · 2 independent channels · 4 contact blocks (NO) per channel · 1 feedback circuit (NC) per channel · Mounting on DIN rail · Screw terminal	E7053S
	Connection cable PC / AS-i safety monitor · Parameter setting cable PC / AS-i safety monitor · Western connector RJ 45 8 poles / D-Sub socket 9 poles · 2.5 m	E7001S
	Connection cable AS-i safety monitor / AS-i safety monitor · Download cable AS-i safety monitor / AS-i safety monitor · Western connector RJ 45 8 poles · 0.3 m	E7002S
	EMERGENCY STOP label IP66 4 languages D,GB,F,I · EMERGENCY STOP label 4 languages for a safe illuminated EMERGENCY STOP button with integrated AS-i interface AC010S / AC011S / AC012S · 50 x 50 mm	E7003S
	EMERGENCY STOP protective collar · EMERGENCY STOP protective collar for safe E-STOP AC010S / AC011S / AC012S · Housing materials: PC GF20 RAL 1004	E7004S
	bridging plug for safety modules · Housing materials: PUR	E7005S
	Adapter plug · straight · M20 - M12 · M12 connector · 0.07 m · Housing materials: polyamide	E7006S

AS-i manuals

Type	Description	Order no.
	ecolog asi system · AS-Interface Manual (German)	AC0115
	ecolog asi system · AS-Interface Manual (English)	AC0116

Scale drawings / drawing no. – CAD download: www.ifm.com

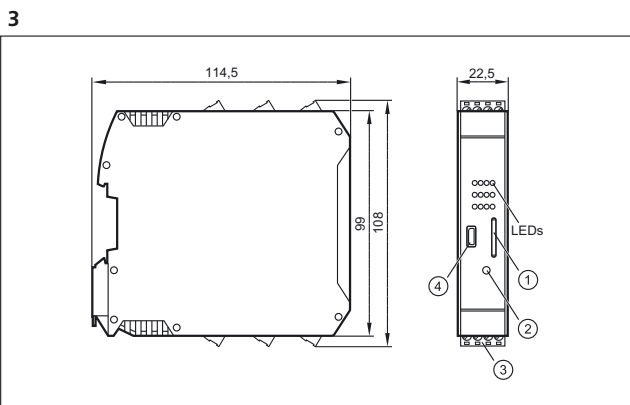
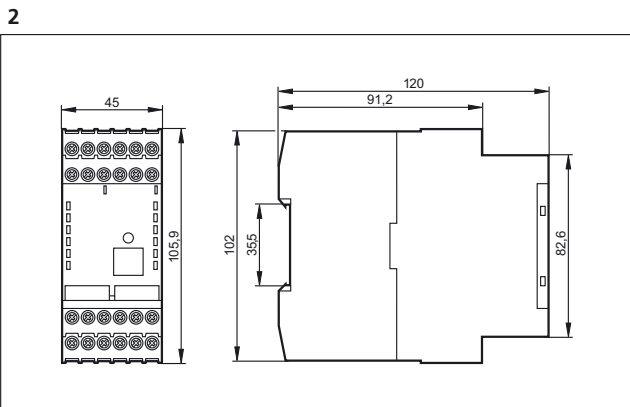
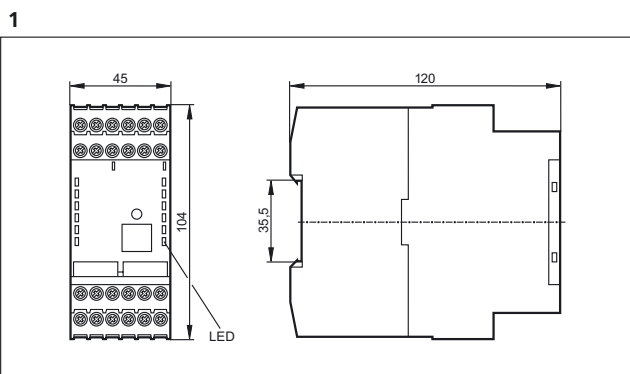

1: Chip card, 2: service button, 3: CombiCon connector with screw terminals, 4: Micro USB interface

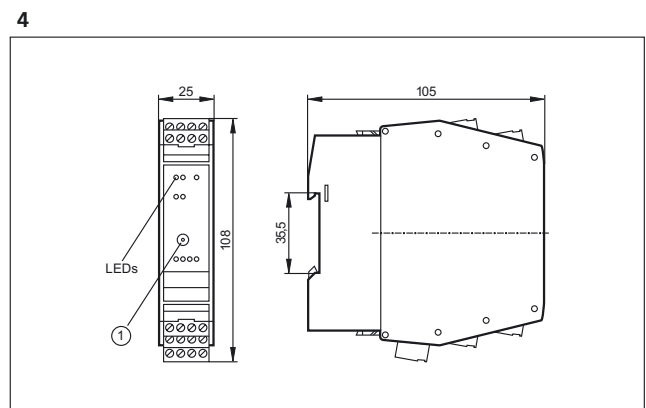

1: Addressing socket

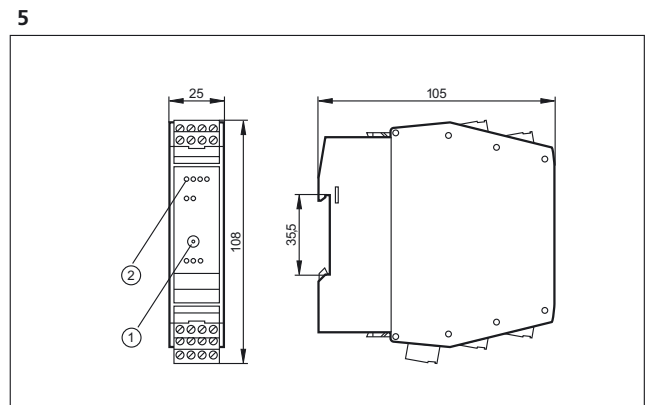

1: Addressing socket, 2: LED

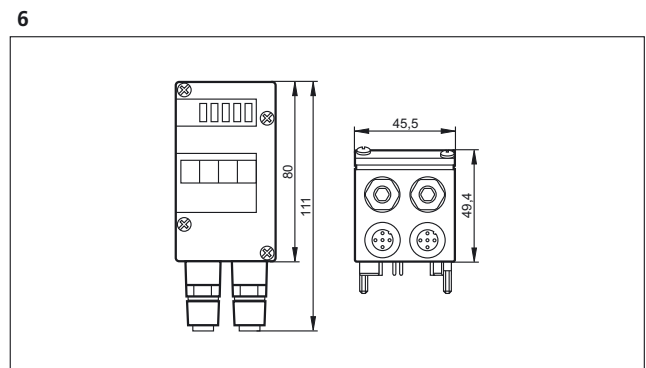

Scale drawings / drawing no. – CAD download: www.ifm.com

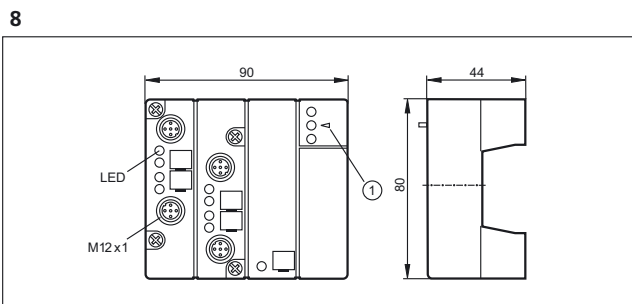
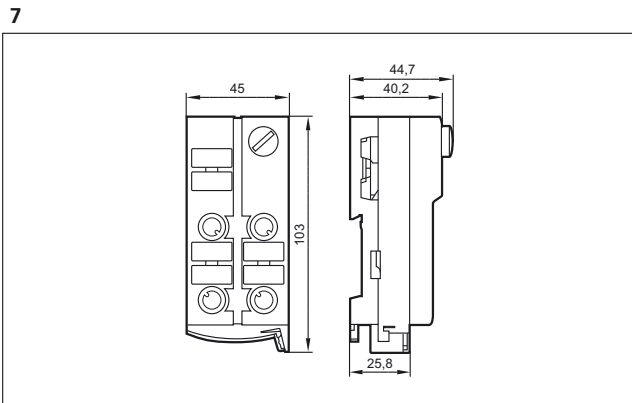

1: fixture infrared adapter

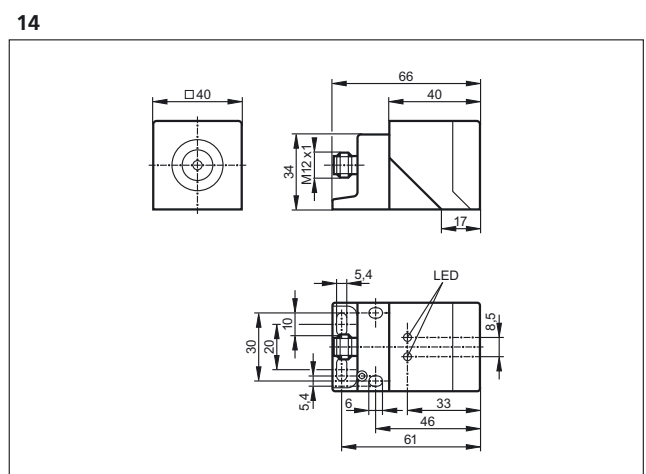
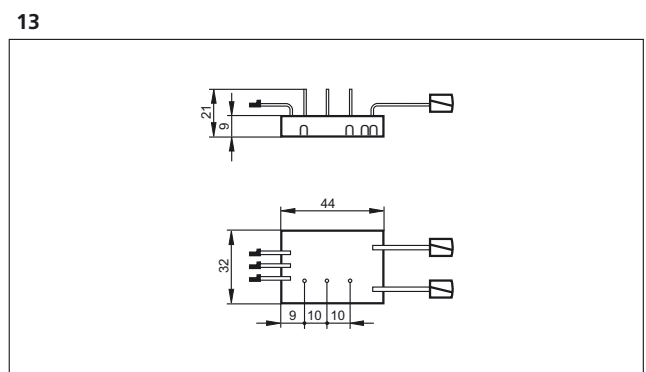
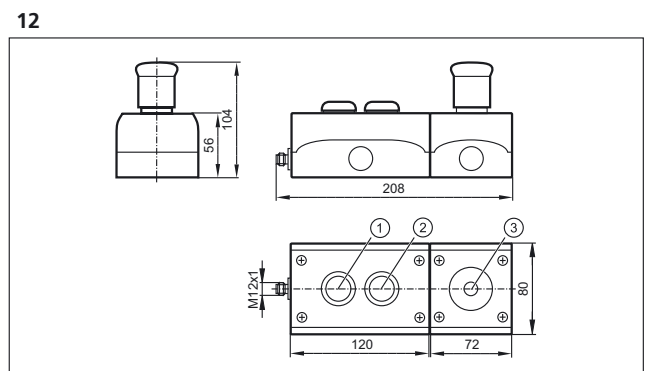
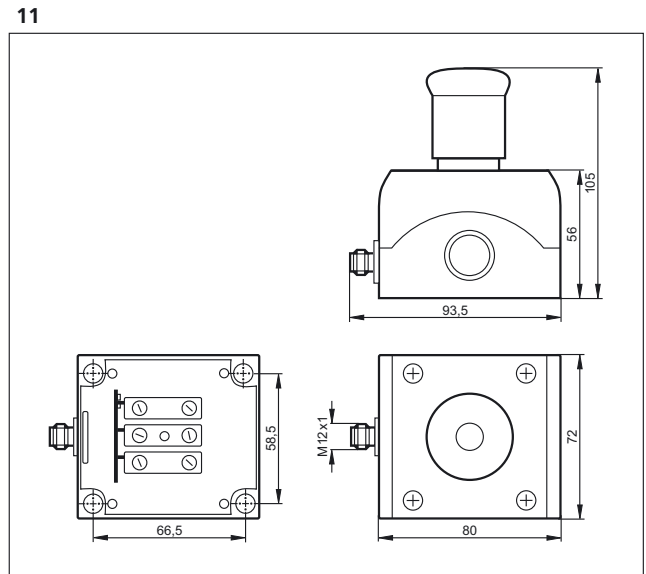
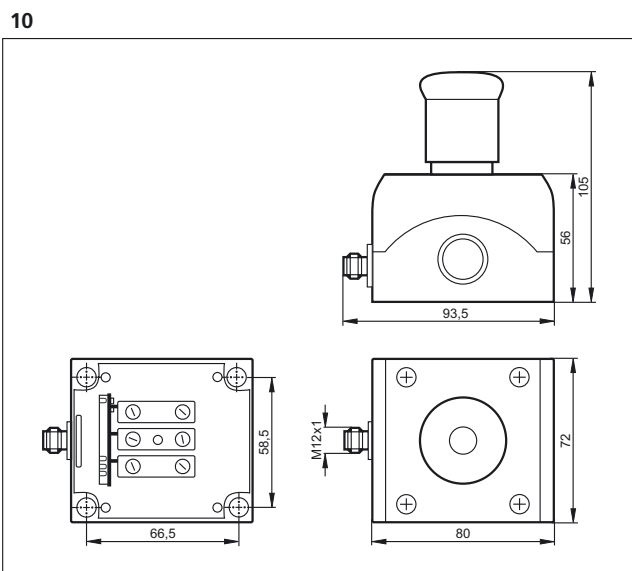
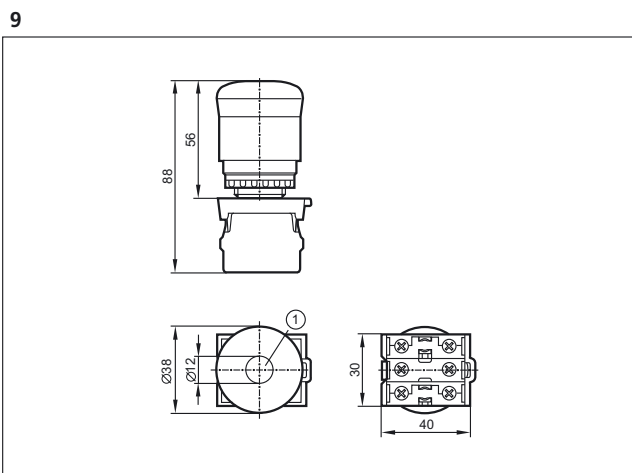

Scale drawings / drawing no. – CAD download: www.ifm.com

15

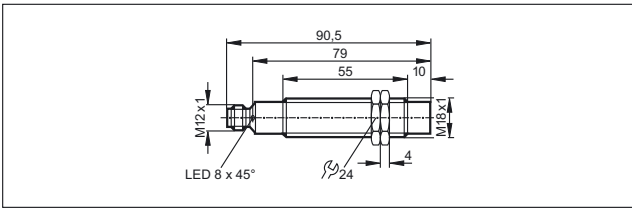

16

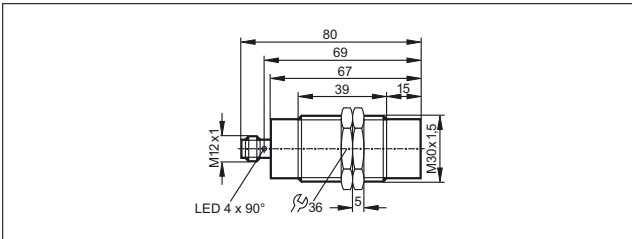

17

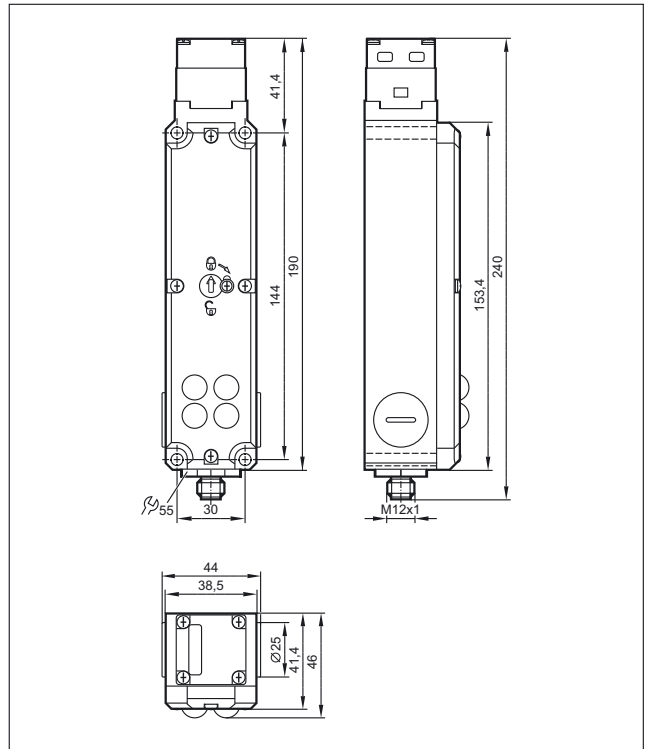

18

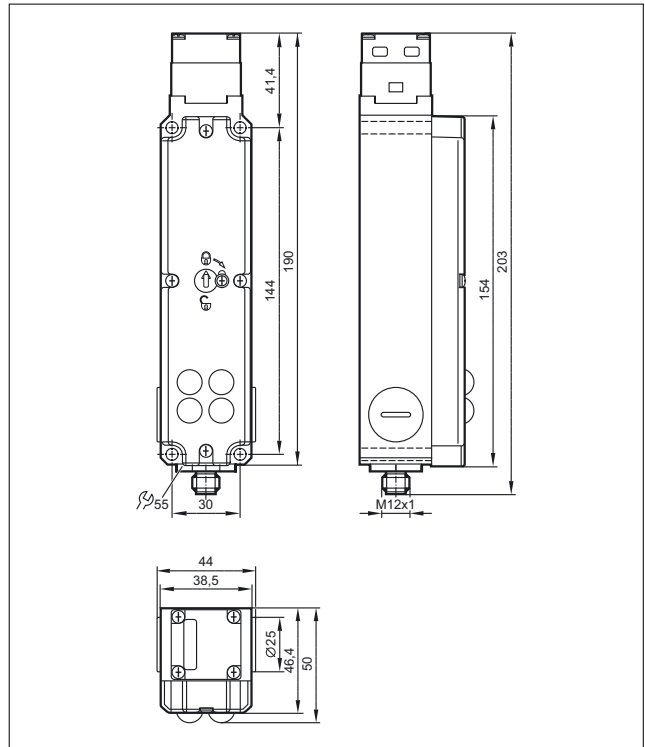

Measuring and monitoring fluids



Pressure, flow, temperature, level and valve sensors for automation in the process industries.



Multiple features

ifm process sensors can be used for control and measurement of the most important parameters of fluids – no matter whether it is pressure, level, flow, temperature or valve position. The range of applications spans from simple monitoring tasks and presence detection of media to accurate and highly repeatable measurements.

The applied microprocessor technology allows for a selection of key parameter settings. A four-digit alphanumeric display and sealed pushbuttons allows local indication and adjustment of the parameters. This can be done with or without the media present, even before arrival on site. Output options include simple switched outputs, pulsed outputs for metering systems, and current or voltage analogue outputs. Most units also have the additional ability to transfer analogue values across IO-Link digitally, without any conversion losses.







As the sensors are mostly in direct contact with the medium, the design of the units and the selection of the materials were driven by the high requirements in the applications. These include in particular resistance to pressure, vibration, shock, media and temperature as well as electromagnetic compatibility and a high ingress protection rating.

Multiple applications

The broad range of ifm fluid sensors can be used across many different applications. The main areas of application are machine building and mobile equipment, hygienic applications (e.g. in the food and beverage industries) and industrial or chemical process plant.

An extensive range of process adapters and mounting accessories guarantees easy mechanical integration of the sensors into the application. Moreover, the units comply with required approvals such as EHEDG, 3A, FDA, KTW, ATEX and E1 for safe use in the application.

Regular examinations in production and high test requirements at the development stage ensure a consistently high quality.

	<i>Pressure sensors</i>	436 - 470
	<i>Flow sensors / flow meters</i>	472 - 505
	<i>Level sensors</i>	506 - 528
	<i>Temperature sensors</i>	530 - 562
	<i>Signal evaluation systems</i>	564 - 569
	<i>Feedback systems for valves and valve actuators</i>	570 - 583



- Sensors and transmitters with integrated control monitor
- Units with special design for hygienic applications
- Measuring principles with overload protection and a good long-term stability
- Measuring range from -1...600 bar
- Variable process connection and sealing technology via adapter

Pressure sensors

ifm offers a wide range of electronic pressure and vacuum sensors to meet the requirements of various industrial applications. The ceramic-capacitive measuring cell, tried and tested millions of times, is complemented by a stainless steel measuring cell with thin-film or thick-film wire strain gauges (series PK, PV, PT) and a piezoresistive measuring technique (for pneumatic applications).

All units have robust housings and do not require moving parts such as pistons or springs. The result: the sensors are extremely shock and vibration resistant and operate without any wear or maintenance.

The tried and tested ceramic-capacitive measuring principle is corrosion-resistant and long-term stable. In the long run this guarantees continuous accuracy of the measured values. The sensors are resistant to dynamic pressure peaks and guarantee high overload resistance even in the case of extreme pressure peaks that occur for example with fast closing valves.

Units with wire strain gauge in thin-film or thick-film technology on a stainless steel measuring cell are distinguished by their very compact and robust design. They can be used in almost all industrial areas. The welded stainless steel measuring cell without any seals ensures a high degree of safety, in particular for applications with gas pressures of up to 600 bar as well as in air-conditioning and refrigerating technology where aggressive coolants (freons) are used.



Local display: the clearly readable LED display shows the current system pressure.

Pressure measurement in pneumatic systems.



System overview	Page
Sensors with switching outputs and analogue outputs, display and IO-Link	438 - 440
Sensors with switching outputs and display with IO-Link	440 - 441
Electronic contact manometers with switching output and analogue output	441 - 442
PK sensors with mechanical setting and switching outputs	442 - 444
PP sensors for mobile and industrial applications with switching outputs, IO-Link	444
Sensors for pneumatic applications	445
PT sensors for industrial applications with analogue outputs	445 - 447
PT / PU sensors for mobile applications with analogue outputs	447 - 448
PA sensors with analogue outputs	448 - 450
Part seat monitoring	450
Sensors for hydrostatic level monitoring	450 - 451
Sensors for hydrostatic level monitoring ATEX category 1G/1D	451
Sensors with ATEX approval 3D	452
Sensors with ATEX approval 3D/3G	452
Full metal sensors for hygienic and wet areas with switching and analogue outputs, IO-Link	452 - 453
Full-metal high-temperature sensors up to 200 °C for hygienic and wet areas with switching output and analogue output, IO-Link	454
Electronic contact manometers for hygienic and wet areas with switching and analogue outputs	454 - 455
PF sensors for hygienic and wet areas with switching and analogue outputs	456
PL / PM sensors without display for hygienic and wet areas with analogue output	456 - 457
PE sensors with display with 2 switching outputs or switching and analogue output	457 - 458
Fixing components for pressure sensors	458
Accessories and software	458 - 459
Certificates	459 - 460
Adapters and accessories for adapters	460 - 461
Flange adapters	461 - 464
Wiring diagrams	464 - 465
Scale drawings / drawing no. – CAD download: www.ifm.com	465 - 470

Sensors with switching outputs and analogue outputs, display and IO-Link

Type	Process connection	Display	Measuring range [bar]	P _{overload} max. [bar]	P _{bursting} min. [bar]	U _b DC [V]	Draw- ing no.	Order no.
------	--------------------	---------	--------------------------	-------------------------------------	-------------------------------------	-----------------------------	---------------------	--------------

M12 connector · Output function 2 x normally open / closed programmable or 1 x normally open / closed programmable + 1 x analogue (4...20 mA / 0...10 V; scaleable 1:5) · Wiring diagram no. 1 · Connector groups 8, 10, 18, 20, 120, 124, 126, 128, 157

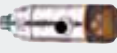

	G ¼ I	Display unit	0...600	800	2500	18...30	1	PN2160
	G ¼ I	Display unit	0...400	800	1700	18...30	1	PN2070
	G ¼ I	Display unit	0...250	500	1200	18...30	1	PN2071
	G ¼ I	Display unit	0...100	300	650	18...30	1	PN2092
	G ¼ I	Display unit	-1...25	150	350	18...30	1	PN2093
	G ¼ I	Display unit	-1...10	75	150	18...30	1	PN2094
	G ¼ I	Display unit	-0.125...2.5	20	50	18...30	1	PN2096
	G ¼ I	Display unit	-0.05...1	10	30	18...30	1	PN2097
	G ¼ I	Display unit	-0.0125...25	10	30	18...30	1	PN2098
	G ¼ I	Display unit	-1...1	20	50	18...30	1	PN2099
	G ¼ I	Display unit	-0.5...0.5	10	30	18...30	1	PN2169
	G ¼ A / M5 I	Display unit	0...600	800	2500	18...30	2	PN2560
	G ¼ A / M5 I	Display unit	0...400	800	1700	18...30	2	PN2570
	G ¼ A / M5 I	Display unit	0...250	500	1200	18...30	2	PN2571
	G ¼ A / M5 I	Display unit	0...100	300	650	18...30	2	PN2592
	G ¼ A / M5 I	Display unit	-1...25	150	350	18...30	2	PN2593

Type	Process connection	Display	Measuring range [bar]	P _{overload} max. [bar]	P _{bursting} min. [bar]	U _b DC [V]	Draw- ing no.	Order no.
------	--------------------	---------	--------------------------	-------------------------------------	-------------------------------------	-----------------------------	---------------------	--------------

M12 connector - Output function 2 x normally open / closed programmable or 1 x normally open / closed programmable + 1 x analogue (4...20 mA / 0...10 V; scaleable 1:5) - Wiring diagram no. 1 - Connector groups 8, 10, 18, 20, 120, 124, 126, 128, 157

	G ¼ A / M5 I	Display unit	-1...10	75	150	18...30	2	PN2594
	G ¼ A / M5 I	Display unit	-0.125...2.5	20	50	18...30	2	PN2596
	G ¼ A / M5 I	Display unit	-0.05...1	10	30	18...30	2	PN2597
	G ¼ A / M5 I	Display unit	-0.0125...0.25	10	30	18...30	2	PN2598
	G ¼ A / M5 I	Display unit	-1...1	20	50	18...30	2	PN2599
	G ¼ A / M5 I	Display unit	-0.5...0.5	10	30	18...30	2	PN2569

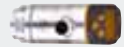
M12 connector - Output function normally open / closed programmable; 4...20 mA or 0...10 V - Wiring diagram no. 1 - Connector groups 8, 10, 18, 20, 120, 124, 126, 128, 157

	G ¼ I	Display unit	0...600	800	2500	18...30	1	PN3160
	G ¼ I	Display unit	0...400	800	1700	18...30	1	PN3070
	G ¼ I	Display unit	0...250	500	1200	18...30	1	PN3071
	G ¼ I	Display unit	0...100	300	650	18...30	1	PN3092
	G ¼ I	Display unit	0...25	150	350	18...30	1	PN3093
	G ¼ I	Display unit	-1...10	75	150	18...30	1	PN3094
	G ¼ I	Display unit	0...2.5	20	50	18...30	1	PN3096
	G ¼ I	Display unit	0...1	10	30	18...30	1	PN3097
	G ¼ I	Display unit	-1...0	20	50	18...30	1	PN3129
	G ¼ A / M5 I	Display unit	0...600	800	2500	18...30	2	PN3560

Type	Process connection	Display	Measuring range [bar]	P _{overload} max. [bar]	P _{bursting} min. [bar]	U _b DC [V]	Draw- ing no.	Order no.
------	--------------------	---------	--------------------------	-------------------------------------	-------------------------------------	-----------------------------	---------------------	--------------

M12 connector · Output function normally open / closed programmable; 4...20 mA or 0...10 V · Wiring diagram no. 1 · Connector groups 8, 10, 18, 20, 120, 124, 126, 128, 157

	G ¼ A / M5 I	Display unit	0...400	800	1700	18...30	2	PN3570
	G ¼ A / M5 I	Display unit	0...250	500	1200	18...30	2	PN3571
	G ¼ A / M5 I	Display unit	0...100	300	650	18...30	2	PN3592
	G ¼ A / M5 I	Display unit	0...25	150	350	18...30	2	PN3593
	G ¼ A / M5 I	Display unit	0...10	75	150	18...30	2	PN3594
	G ¼ A / M5 I	Display unit	0...2.5	20	50	18...30	2	PN3596
	G ¼ A / M5 I	Display unit	0...1	10	30	18...30	2	PN3597
	G ¼ A / M5 I	Display unit	-1...0	20	50	18...30	2	PN3529

Sensors with switching outputs and display with IO-Link

Type	Process connection	Display	Measuring range [bar]	P _{overload} max. [bar]	P _{bursting} min. [bar]	U _b DC [V]	Draw- ing no.	Order no.
------	--------------------	---------	--------------------------	-------------------------------------	-------------------------------------	-----------------------------	---------------------	--------------

M12 connector · Output function 2 x normally open / closed programmable · DC PNP/NPN · Wiring diagram no. 1 · Connector groups 8, 10, 18, 20, 120, 124, 126, 128, 157

	G ¼ I	Display unit	0...600	800	2500	18...30	1	PN7160
	G ¼ I	Display unit	0...400	800	1700	18...30	1	PN7070
	G ¼ I	Display unit	0...250	500	1100	18...30	1	PN7071
	G ¼ I	Display unit	0...100	300	650	18...30	1	PN7092
	G ¼ I	Display unit	0...25	150	350	18...30	1	PN7093
	G ¼ I	Display unit	-1...10	75	150	18...30	1	PN7094

Type	Process connection	Display	Measuring range [bar]	P _{overload} max. [bar]	P _{bursting} min. [bar]	U _b DC [V]	Draw- ing no.	Order no.
------	--------------------	---------	--------------------------	-------------------------------------	-------------------------------------	-----------------------------	---------------------	--------------

M12 connector · Output function 2 x normally open / closed programmable · DC PNP/NPN · Wiring diagram no. 1 · Connector groups 8, 10, 18, 20, 120, 124, 126, 128, 157

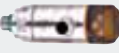
	G ¼ I	Display unit	0...2.5	20	50	18...30	1	PN7096
	G ¼ I	Display unit	0...1	10	30	18...30	1	PN7097
	G ¼ I	Display unit	-1...1	20	50	18...30	1	PN7099
	G ¼ A / M5 I	Display unit	0...600	800	2500	18...30	2	PN7560
	G ¼ A / M5 I	Display unit	0...400	800	1700	18...30	2	PN7570
	G ¼ A / M5 I	Display unit	0...250	500	1100	18...30	2	PN7571
	G ¼ A / M5 I	Display unit	0...100	300	650	18...30	2	PN7592
	G ¼ A / M5 I	Display unit	0...25	150	350	18...30	2	PN7593
	G ¼ A / M5 I	Display unit	-1...10	75	150	18...30	2	PN7594
	G ¼ A / M5 I	Display unit	0...2.5	20	50	18...30	2	PN7596
	G ¼ A / M5 I	Display unit	0...1	10	30	18...30	2	PN7597
	G ¼ A / M5 I	Display unit	-1...1	20	50	18...30	2	PN7599

Electronic contact manometers with switching output and analogue output

Type	Process connection	Display	Measuring range [bar]	P _{overload} max. [bar]	P _{bursting} min. [bar]	U _b DC [V]	Draw- ing no.	Order no.
------	--------------------	---------	--------------------------	-------------------------------------	-------------------------------------	-----------------------------	---------------------	--------------



M12 connector · Output function 1 x normally open / closed programmable + 1 x analogue (4...20 / 20...4 mA, scalable) · DC PNP/NPN · Wiring diagram no. 18 · Connector groups 8, 10, 18, 20, 120, 124, 126, 128, 157

	G ½	Display unit	0...400	800	1200	18...32	3	PG2450
	G ½	Display unit	0...250	600	1000	18...32	3	PG2451

Process sensors

Type	Process connection	Display	Measuring range [bar]	P _{overload} max. [bar]	P _{bursting} min. [bar]	U _b DC [V]	Draw- ing no.	Order no.
M12 connector · Output function 1 x normally open / closed programmable + 1 x analogue (4...20 / 20...4 mA, scalable) · DC PNP/NPN · Wiring diagram no. 18 · Connector groups 8, 10, 18, 20, 120, 124, 126, 128, 157								
	G ½	Display unit	0...100	300	700	18...32	3	PG2452
	G ½	Display unit	-1...25	100	300	18...32	3	PG2453
	G ½	Display unit	-1...10	50	150	18...32	3	PG2454
	G ½	Display unit	-1...4	30	100	18...32	3	PG2455
	G ½	Display unit	-0.125...2.5	20	50	18...32	3	PG2456
	G ½	Display unit	-0.05...1	10	30	18...32	3	PG2457
	G ½	Display unit	-0.0125...0.25	10	30	18...32	3	PG2458
	G ½	Display unit	-0.005...0.1	4	30	18...32	3	PG2489
	G ½	Display unit	-1...1	10	30	18...32	3	PG2409

PK sensors with mechanical setting and switching outputs

Type	Process connection	Display	Measuring range [bar]	P _{overload} max. [bar]	P _{bursting} min. [bar]	U _b DC [V]	Draw- ing no.	Order no.
M12 connector · Output function  · DC PNP · Wiring diagram no. 2 · Connector groups 8, 9, 10, 11, 18, 20, 120, 124, 126, 128, 130, 131, 157, 158								
	G ¼ A / M5 I	Operation	0...400	600	1600	9.6...32	4	PK5520
	G ¼ A / M5 I	Operation	0...250	400	1000	9.6...32	4	PK5521
	G ¼ A / M5 I	Operation	0...100	200	1000	9.6...32	4	PK5522
	G ¼ A / M5 I	Operation	0...25	60	500	9.6...32	4	PK5523
	G ¼ A / M5 I	Operation	0...10	25	300	9.6...32	4	PK5524

Type	Process connection	Display	Measuring range [bar]	P _{overload} max. [bar]	P _{bursting} min. [bar]	U _b DC [V]	Draw- ing no.	Order no.
------	--------------------	---------	--------------------------	-------------------------------------	-------------------------------------	-----------------------------	---------------------	--------------

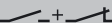
M12 connector · Output function  · DC PNP · Wiring diagram no. 3 · Connector groups 8, 9, 10, 11, 18, 20, 120, 124, 126, 128, 130, 131, 157, 158

	G ¼ A / M5 I	Operation	0...400	600	1600	9.6...32	4	PK6520
	G ¼ A / M5 I	Operation	0...250	400	1000	9.6...32	4	PK6521
	G ¼ A / M5 I	Operation	0...100	200	1000	9.6...32	4	PK6522
	G ¼ A / M5 I	Operation	0...25	60	500	9.6...32	4	PK6523
	G ¼ A / M5 I	Operation	0...10	25	300	9.6...32	4	PK6524

M12 connector · Output function  · DC PNP · Wiring diagram no. 4 · Connector groups 8, 9, 10, 11, 18, 20, 120, 124, 126, 128, 130, 131, 157, 158

	G ¼ A / M5 I	Switching status	0...400	600	1600	9.6...32	4	PK7520
	G ¼ A / M5 I	Switching status	0...250	400	1000	9.6...32	4	PK7521
	G ¼ A / M5 I	Switching status	0...100	200	1000	9.6...32	4	PK7522
	G ¼ A / M5 I	Switching status	0...25	60	500	9.6...32	4	PK7523
	G ¼ A / M5 I	Switching status	0...10	25	300	9.6...32	4	PK7524

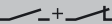
M12 connector · Output function  · DC PNP · Wiring diagram no. 3 · Connector groups 8, 9, 10, 11, 18, 20, 120, 124, 126, 128, 130, 131, 157, 158

	R¼ A / M5 I	Operation	0...100	200	1000	9.6...32	5	PK6732
	R¼ A / M5 I	Operation	0...10	25	300	9.6...32	5	PK6734

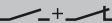
M12 connector · Output function  · DC NPN · Wiring diagram no. 5 · Connector groups 8, 10, 18, 20, 120, 124, 126, 128, 157

	R¼ A / M5 I	Operation	0...400	600	1600	9.6...32	5	PK8730
	R¼ A / M5 I	Operation	0...250	400	1000	9.6...32	5	PK8731
	R¼ A / M5 I	Operation	0...100	200	1000	9.6...32	5	PK8732

Process sensors

Type	Process connection	Display	Measuring range [bar]	P _{overload} max. [bar]	P _{bursting} min. [bar]	U _b DC [V]	Draw- ing no.	Order no.
------	--------------------	---------	--------------------------	-------------------------------------	-------------------------------------	-----------------------------	---------------------	--------------

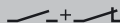
M12 connector · Output function  · DC NPN · Wiring diagram no. 5 · Connector groups 8, 10, 18, 20, 120, 124, 126, 128, 157



R¼ A / M5 I	Operation	0...10	25	300	9.6...32	5	PK8734
-------------	-----------	--------	----	-----	----------	---	--------

PP sensors for mobile and industrial applications with switching outputs, IO-Link

Type	Process connection	Display	Measuring range [bar]	P _{overload} max. [bar]	P _{bursting} min. [bar]	U _b DC [V]	Draw- ing no.	Order no.
------	--------------------	---------	--------------------------	-------------------------------------	-------------------------------------	-----------------------------	---------------------	--------------

M12 connector · Output function 2 x normally open / closed programmable or 1 x normally open / closed programmable + 1 x normally closed (diagnostic function) · DC PNP · Wiring diagram no. 6 · Connector groups 8, 9, 10, 11, 18, 20, 120, 124, 126, 128, 130, 131, 157, 158



G ¼ A / M5 I	Operation	0...400	600	1000	9.6...36	6	PP7550
G ¼ A / M5 I	Operation	0...250	400	850	9.6...36	6	PP7551
G ¼ A / M5 I	Operation	0...100	300	650	9.6...36	7	PP7552
G ¼ A / M5 I	Operation	0...25	150	350	9.6...36	8	PP7553
G ¼ A / M5 I	Operation	-1...10	75	150	9.6...36	8	PP7554
G ¼ A / M5 I	Operation	0...2.5	20	50	9.6...36	8	PP7556

M12 connector · Output function 2 x normally open / closed programmable or 1 x normally open / closed programmable + 1 x normally closed (diagnostic function) · DC NPN · Wiring diagram no. 6 · Connector groups 8, 9, 10, 11, 18, 20, 120, 124, 126, 128, 130, 131, 157, 158

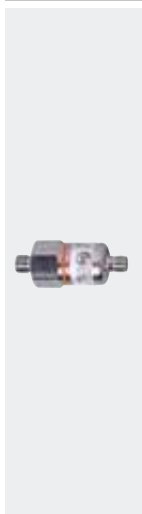

G ¼ A / M5 I	Operation	0...400	600	1000	9.6...36	6	PP0520
G ¼ A / M5 I	Operation	0...250	400	850	9.6...36	6	PP0521
G ¼ A / M5 I	Operation	0...100	300	650	9.6...36	7	PP0522
G ¼ A / M5 I	Operation	0...25	150	350	9.6...36	8	PP0523
G ¼ A / M5 I	Operation	-1...10	75	150	9.6...36	8	PP0524

Sensors for pneumatic applications

Type	Process connection	Display	Measuring range [bar]	P _{overload} max. [bar]	P _{bursting} min. [bar]	U _b DC [V]	Drawing no.	Order no.
------	--------------------	---------	--------------------------	-------------------------------------	-------------------------------------	-----------------------------	-------------	-----------

M12 connector · Output function 2 x normally open/closed programmable or 1 x normally open/closed programmable + 1 x normally closed (diagnostic function) · DC PNP/NPN · Wiring diagram no. 19 · Connector groups 8, 9, 10, 11, 18, 20, 120, 124, 126, 128, 130, 131, 157, 158

	G 1/8 I	Display unit	-1...1	20	30	18...36	9	PN7809
	G 1/8 I	Display unit	-1...10	20	30	18...36	9	PN7834

M8 connector · Output function 2 x normally open / closed programmable or 1 x normally open / closed programmable + 1 x normally closed (diagnostic function) · DC PNP · Wiring diagram no. 4 · Connector groups 4, 5, 74, 80, 124

	G 1/8 I	Display unit	-1...1	20	30	18...32	10	PQ7809
	G 1/8 I	Display unit	-1...10	20	30	18...32	10	PQ7834

M8 connector · Output function 2 x normally open / closed programmable or 1 x normally open / closed programmable + 1 x normally closed (diagnostic function) · DC NPN · Wiring diagram no. 7 · Connector groups 4, 5, 74, 80, 124

	G 1/8 I	Display unit	-1...1	20	30	18...32	10	PQ0809
	G 1/8 I	Display unit	-1...10	20	30	18...32	10	PQ0834

M8 connector · Output function 1 x NO / NC programmable + 1 x current output · DC PNP · Wiring diagram no. 8 · Connector groups 4, 5, 74, 80, 124

	G 1/8 I / M5 I	Display unit	-1...1	20	30	18...32	11	PQ3809
	G 1/8 I / M5 I	Display unit	-1...10	20	30	18...32	11	PQ3834

PT sensors for industrial applications with analogue outputs

Type	Process connection	Display	Measuring range [bar]	P _{overload} max. [bar]	P _{bursting} min. [bar]	U _b DC [V]	Drawing no.	Order no.
------	--------------------	---------	--------------------------	-------------------------------------	-------------------------------------	-----------------------------	-------------	-----------

M12 connector · Output function 4...20 mA analogue · DC · Wiring diagram no. 9 · Connector groups 8, 10, 18, 20, 120, 124, 126, 128, 157

	G ¼ A	–	0...600	1500	2500	8.5...36	12	PT5460
	G ¼ A	–	0...400	1000	1700	8.5...36	12	PT5400
	G ¼ A	–	0...250	625	1200	8.5...36	12	PT5401

Type	Process connection	Display	Measuring range [bar]	P _{overload} max. [bar]	P _{bursting} min. [bar]	U _b DC [V]	Draw- ing no.	Order no.
------	--------------------	---------	--------------------------	-------------------------------------	-------------------------------------	-----------------------------	---------------------	--------------

M12 connector · Output function 4...20 mA analogue · DC · Wiring diagram no. 9 · Connector groups 8, 10, 18, 20, 120, 124, 126, 128, 157

	G ¼ A	–	0...160	400	1100	8.5...36	12	PT5412
	G ¼ A	–	0...100	250	1000	8.5...36	12	PT5402
	G ¼ A	–	0...60	150	900	8.5...36	12	PT5423
	G ¼ A	–	0...40	100	800	8.5...36	12	PT5443
	G ¼ A	–	0...25	65	600	8.5...36	12	PT5403
	G ¼ A	–	0...16	40	450	8.5...36	12	PT5414
	G ¼ A	–	0...10	25	300	8.5...36	12	PT5404
	G ¼ A	–	0...6	15	200	8.5...36	12	PT5415

M12 connector · Output function 0...10 V analogue · DC · Wiring diagram no. 10 · Connector groups 8, 10, 18, 20, 120, 124, 126, 128, 157

	G ¼ A	–	0...600	1500	2500	16...36	12	PU5460
	G ¼ A	–	0...400	1000	1700	16...36	12	PU5400
	G ¼ A	–	0...250	625	1200	16...36	12	PU5401
	G ¼ A	–	0...160	400	1100	16...36	12	PU5412
	G ¼ A	–	0...100	250	1000	16...36	12	PU5402
	G ¼ A	–	0...40	100	800	16...36	12	PU5443
	G ¼ A	–	0...60	150	900	16...36	12	PU5423
	G ¼ A	–	0...25	65	600	16...36	12	PU5403

Type	Process connection	Display	Measuring range [bar]	P _{overload} max. [bar]	P _{bursting} min. [bar]	U _b DC [V]	Draw- ing no.	Order no.
------	--------------------	---------	--------------------------	-------------------------------------	-------------------------------------	-----------------------------	---------------------	--------------

M12 connector · Output function 0...10 V analogue · DC · Wiring diagram no. 10 · Connector groups 8, 10, 18, 20, 120, 124, 126, 128, 157

	G ¼ A	–	0...16	40	450	16...36	12	PU5414
	G ¼ A	–	0...10	25	300	16...36	12	PU5404
	G ¼ A	–	0...6	15	200	16...36	12	PU5415

PT / PU sensors for mobile applications with analogue outputs

Type	Process connection	Display	Measuring range [bar]	P _{overload} max. [bar]	P _{bursting} min. [bar]	U _b DC [V]	Draw- ing no.	Order no.
------	--------------------	---------	--------------------------	-------------------------------------	-------------------------------------	-----------------------------	---------------------	--------------

M12 connector · Output function 4...20 mA analogue · DC · Wiring diagram no. 11 · Connector group 157

	G ¼ A	–	0...400	600	1600	8.5...36	13	PT3550
	G ¼ A	–	0...250	400	1000	8.5...36	13	PT3551
	G ¼ A	–	0...100	200	1000	8.5...36	13	PT3552
	G ¼ A	–	0...25	60	600	8.5...36	13	PT3553
	G ¼ A	–	0...10	25	300	8.5...36	13	PT3554

M12 connector · Output function 0...10 V analogue · DC · Wiring diagram no. 12 · Connector group 157

	G ¼ A	–	0...400	600	1600	16...36	13	PT9550
	G ¼ A	–	0...250	400	1000	16...36	13	PT9551
	G ¼ A	–	0...100	200	1000	16...36	13	PT9552
	G ¼ A	–	0...25	60	600	16...36	13	PT9553
	G ¼ A	–	0...10	25	300	16...36	13	PT9554

Process sensors

Type	Process connection	Display	Measuring range [bar]	P _{overload} max. [bar]	P _{bursting} min. [bar]	U _b DC [V]	Draw- ing no.	Order no.
------	--------------------	---------	--------------------------	-------------------------------------	-------------------------------------	-----------------------------	---------------------	--------------

DEUTSCH connector DT04-3P · Output function 0...10 V analogue · DC · Wiring diagram no. 13

	G ¼ A	–	0...600	1500	2500	16...32	14	PU5760
	G ¼ A	–	0...400	1000	1700	16...32	14	PU5700
	G ¼ A	–	0...250	625	1200	16...32	14	PU5701
	G ¼ A	–	0...100	250	1000	16...32	14	PU5702
	G ¼ A	–	0...25	65	600	16...32	14	PU5703
	G ¼ A	–	0...10	25	300	16...32	14	PU5704

AMP Superseal · Output function 0...10 V analogue · DC · Wiring diagram no. 14



	G ¼ A	–	0...600	1500	2500	16...32	15	PU5660
	G ¼ A	–	0...400	1000	1700	16...32	15	PU5600
	G ¼ A	–	0...250	625	1200	16...32	15	PU5601
	G ¼ A	–	0...100	250	1000	16...32	15	PU5602
	G ¼ A	–	0...25	65	600	16...32	15	PU5603
	G ¼ A	–	0...10	25	300	16...32	15	PU5604

PA sensors with analogue outputs

Type	Process connection	Display	Measuring range [bar]	P _{overload} max. [bar]	P _{bursting} min. [bar]	U _b DC [V]	Draw- ing no.	Order no.
------	--------------------	---------	--------------------------	-------------------------------------	-------------------------------------	-----------------------------	---------------------	--------------

M12 connector · Output function 4...20 mA · DC · Wiring diagram no. 11 · Connector groups 8, 10, 18, 20, 120, 124, 126, 128, 157

	G ¼ I	–	0...600	800	1200	9.6...32	16	PA3060
---	-------	---	---------	-----	------	----------	----	--------

Type	Process connection	Display	Measuring range [bar]	P _{overload} max. [bar]	P _{bursting} min. [bar]	U _b DC [V]	Draw- ing no.	Order no.
M12 connector · Output function 4...20 mA · DC · Wiring diagram no. 11 · Connector groups 8, 10, 18, 20, 120, 124, 126, 128, 157								
	G 1/4 I	–	0...400	600	1000	9.6...32	17	PA3020
	G 1/4 I	–	0...250	400	850	9.6...32	17	PA3021
	G 1/4 I	–	0...100	300	650	9.6...32	18	PA3022
	G 1/4 I	–	0...25	150	350	9.6...32	18	PA3023
	G 1/4 I	–	0...10	75	150	9.6...32	18	PA3024
	G 1/4 I	–	0...2.5	20	50	9.6...32	18	PA3026
	G 1/4 I	–	0...1	10	30	9.6...32	18	PA3027
	G 1/4 I	–	0...0.25	10	30	9.6...32	18	PA3028
	G 1/4 I	–	-1...0	10	30	9.6...32	18	PA3029
	G 1/4 A / M5 I	–	0...250	400	850	9.6...32	19	PA3521
	G 1/4 A / M5 I	–	0...100	300	650	9.6...32	19	PA3522
	G 1/4 A / M5 I	–	0...25	150	350	9.6...32	19	PA3523
	G 1/4 A / M5 I	–	0...10	75	150	9.6...32	19	PA3524
	G 1/4 A / M5 I	–	0...2.5	20	50	9.6...32	19	PA3526
	G 1/4 A / M5 I	–	0...0.25	10	30	9.6...32	19	PA3528
M12 connector · Output function 4...20 mA · DC · Wiring diagram no. 9 · Connector groups 8, 10, 18, 20, 120, 124, 126, 128, 157								
	G 1/4 A / M5 I	–	0...0.1	4	30	9.6...32	19	PA3589

Process sensors

Type	Process connection	Display	Measuring range [bar]	P _{overload} max. [bar]	P _{bursting} min. [bar]	U _b DC [V]	Draw- ing no.	Order no.
M12 connector · Output function 0...10 V · DC · Wiring diagram no. 12 · Connector groups 8, 10, 18, 20, 120, 124, 126, 128, 157								
	G ¼ I	–	0...600	800	1200	16...32	16	PA9060
	G ¼ I	–	0...400	600	1000	16...32	17	PA9020
	G ¼ I	–	0...250	400	850	16...32	18	PA9021
	G ¼ I	–	0...100	300	650	16...32	18	PA9022
	G ¼ I	–	0...25	150	350	16...32	18	PA9023
	G ¼ I	–	0...10	75	150	16...32	18	PA9024
	G ¼ I	–	0...2.5	20	50	16...32	18	PA9026
	G ¼ I	–	0...1	10	30	16...32	18	PA9027
	G ¼ I	–	0...0.25	10	30	16...32	18	PA9028
	G ¼ I	–	-1...0	10	30	16...32	18	PA9029

Part seat monitoring

Type	Description	Order no.
	Control unit for part seat monitoring · Setting by adjustment of the pneumatic bridge · Integrated pressure sensor with 2 switching outputs · and 4-digit alphanumerical display for trend display or display of current pressure · Cable	PS7570

Sensors for hydrostatic level monitoring

Type	Measuring range [bar]	Cable length / material	P _{overload} max. [bar]	P _{bursting} min. [bar]	U _b DC [V]	Draw- ing no.	Order no.
Output function 4...20 mA analogue · Wiring diagram no. 15							
	0...0.25	5 m PUR cable	2	2.4	10...30	20	PS3208

Type	Measuring range [bar]	Cable length / material	P _{overload} max. [bar]	P _{bursting} min. [bar]	U _b DC [V]	Draw- ing no.	Order no.
------	--------------------------	----------------------------	-------------------------------------	-------------------------------------	-----------------------------	---------------------	--------------

Output function 4...20 mA analogue · Wiring diagram no. 15

	0...0.6	10 m PUR cable	4	4.8	10...30	20	PS3407
	0...0.6	15 m PUR cable	4	4.8	10...30	20	PS3427
	0...0.6	30 m PUR cable	4	4.8	10...30	20	PS3607
	0...1	15 m PUR cable	5	6	10...30	20	PS3417
	0...1	30 m PUR cable	5	6	10...30	20	PS3617

Output function 4...20 mA analogue · Wiring diagram no. 16

	0...0.25	5 m FEP cable	2	2.4	10...30	21	PS4208
	0...0.6	10 m FEP cable	3	4	10...30	21	PS4407

· Wiring diagram no. 16

	0...1	15 m FEP cable	5	6	10...30	21	PS4417
---	-------	-------------------	---	---	---------	----	--------

Sensors for hydrostatic level monitoring ATEX category 1G/1D

Type	Measuring range [bar]	Cable length / material	P _{overload} max. [bar]	P _{bursting} min. [bar]	U _b DC [V]	Draw- ing no.	Order no.
------	--------------------------	----------------------------	-------------------------------------	-------------------------------------	-----------------------------	---------------------	--------------

Output function 4...20 mA analogue · Wiring diagram no. 16

	0...0.25	5 m FEP cable	2	2.4	10...30	21	PS308A
	0...0.6	10 m FEP cable	4	4.8	10...30	21	PS307A
	0...1	15 m FEP cable	5	6	10...30	21	PS317A

Sensors with ATEX approval 3D

Type	Process connection	Display	Measuring range [bar]	P _{overload} max. [bar]	P _{bursting} min. [bar]	U _b DC [V]	Drawing no.	Order no.
------	--------------------	---------	--------------------------	-------------------------------------	-------------------------------------	-----------------------------	-------------	-----------

M12 connector · Output function normally open / closed programmable; 4...20 mA or 0...10 V · DC PNP · Wiring diagram no. 17 · Connector groups 154, 156

	G ¼ I	Display unit	-1...10	75	150	18...36	22	PN004A
	G ¼ I	Display unit	0...2.5	20	50	18...36	22	PN006A
	G ¼ I	Display unit	0...1	10	30	18...36	22	PN007A

M12 connector · Output function 2 x normally open / closed programmable or 1 x normally open / closed programmable + 1 x normally closed (diagnostic function) · DC PNP/NPN · Wiring diagram no. 19 · Connector groups 154, 156

	G ¼ I	Display unit	-1...10	75	150	18...36	22	PN014A
	G ¼ I	Display unit	0...2.5	20	50	18...36	22	PN016A

Sensors with ATEX approval 3D/3G

Type	Process connection	Display	Measuring range [bar]	P _{overload} max. [bar]	P _{bursting} min. [bar]	U _b DC [V]	Drawing no.	Order no.
------	--------------------	---------	--------------------------	-------------------------------------	-------------------------------------	-----------------------------	-------------	-----------

M12 connector · Output function 1 x normally open / closed programmable + 1 x analogue (I / U, scaleable 1:4) · DC PNP/NPN · Wiring diagram no. 18 · Connector groups 154, 156



	Sealing cone G1 male	Display unit	-1...25	100	350	18...32	23	PI003A
	Sealing cone G1 male	Display unit	-0.0124...0.25	10	30	18...32	23	PI008A
	Sealing cone G1 male	Display unit	-1...1	10	30	18...32	23	PI009A

Full metal sensors for hygienic and wet areas with switching and analogue outputs, IO-Link

Type	Process connection	Display	Measuring range [bar]	P _{overload} max. [bar]	P _{bursting} min. [bar]	U _b DC [V]	Drawing no.	Order no.
------	--------------------	---------	--------------------------	-------------------------------------	-------------------------------------	-----------------------------	-------------	-----------

M12 connector · Output function 1 x normally open / normally closed programmable + 1 x normally open / normally closed programmable or 1 x analogue (4...20 / 20...4 mA, scalable) · Wiring diagram no. 20 · Connector groups 8, 10, 18, 20, 120, 124, 126, 128, 157

	Aseptoflex Vario	Display unit	-1...25	100	350	20...32	24	PI2793
---	------------------	--------------	---------	-----	-----	---------	----	--------



Type	Process connection	Display	Measuring range [bar]	P _{overload} max. [bar]	P _{bursting} min. [bar]	U _b DC [V]	Draw- ing no.	Order no.
M12 connector · Output function 1 x normally open / normally closed programmable + 1 x normally open / normally closed programmable or 1 x analogue (4...20 / 20...4 mA, scalable) · Wiring diagram no. 20 · Connector groups 8, 10, 18, 20, 120, 124, 126, 128, 157								
	Aseptoflex Vario	Display unit	-1...10	50	150	20...32	24	PI2794
	Aseptoflex Vario	Display unit	-1...4	30	100	20...32	24	PI2795
	Aseptoflex Vario	Display unit	-0.124...2.5	20	50	20...32	24	PI2796
	Aseptoflex Vario	Display unit	-0.05...1	10	30	20...32	24	PI2797
	Aseptoflex Vario	Display unit	-0.0124...0.25	10	30	20...32	24	PI2798
	Aseptoflex Vario	Display unit	-0.005...0.1	4	30	20...32	24	PI2789
	Aseptoflex Vario	Display unit	-1...1	10	30	20...32	24	PI2799
	Sealing cone G1 male	Display unit	-1...25	100	350	20...32	25	PI2893*
	Sealing cone G1 male	Display unit	-1...10	50	150	20...32	25	PI2894*
	Sealing cone G1 male	Display unit	-1...4	30	100	20...32	25	PI2895*
	Sealing cone G1 male	Display unit	-0.124...2.5	20	50	20...32	25	PI2896*
	Sealing cone G1 male	Display unit	-0.05...1	10	30	20...32	25	PI2897*
	Sealing cone G1 male	Display unit	-0.0124...0.25	10	30	20...32	25	PI2898*
	Sealing cone G1 male	Display unit	-0.005...0.1	4	30	20...32	25	PI2889*
Sealing cone G1 male	Display unit	-1...1	10	30	20...32	25	PI2899*	

* Attention: The unit must only be installed in a process connection for G1 sealing cone! The G1 male sealing cone of the unit is only suited for adapters with metal end stop!

Full-metal high-temperature sensors up to 200 °C for hygienic and wet areas with switching output and analogue output, IO-Link

Type	Process connection	Display	Measuring range [bar]	P _{overload} max. [bar]	P _{bursting} min. [bar]	U _b DC [V]	Draw- ing no.	Order no.
------	--------------------	---------	--------------------------	-------------------------------------	-------------------------------------	-----------------------------	---------------------	--------------

M12 connector · Output function 1 x normally open / normally closed programmable + 1 x normally open / normally closed programmable or 1 x analogue (4...20 / 20...4 mA, scalable) · Wiring diagram no. 20 · Connector groups 8, 10, 18, 20, 120, 124, 126, 128, 157



	Clamp DN 38 / 1 1/2"	Display unit	-1...25	80	150	20...32	26	PI2203
	Clamp DN 38 / 1 1/2"	Display unit	-1...10	50	100	20...32	26	PI2204
	Clamp DN 38 / 1 1/2"	Display unit	-1...4	30	50	20...32	26	PI2205
	Clamp DN 38 / 1 1/2"	Display unit	-0.124...2.5	20	50	20...32	26	PI2206
	Clamp DN 38 / 1 1/2"	Display unit	-0.05...1	10	30	20...32	26	PI2207
	Clamp DN 38 / 1 1/2"	Display unit	-1...1	10	30	20...32	26	PI2209
	Clamp DN 51 / 2"	Display unit	-1...25	80	150	20...32	27	PI2303
	Clamp DN 51 / 2"	Display unit	-1...10	50	100	20...32	27	PI2304
	Clamp DN 51 / 2"	Display unit	-1...4	30	50	20...32	27	PI2305
	Clamp DN 51 / 2"	Display unit	-0.124...2.5	20	50	20...32	27	PI2306
	Clamp DN 51 / 2"	Display unit	-0.05...1	10	30	20...32	27	PI2307
	Clamp DN 51 / 2"	Display unit	-1...1	10	30	20...32	27	PI2309

Electronic contact manometers for hygienic and wet areas with switching and analogue outputs

Type	Process connection	Display	Measuring range [bar]	P _{overload} max. [bar]	P _{bursting} min. [bar]	U _b DC [V]	Draw- ing no.	Order no.
------	--------------------	---------	--------------------------	-------------------------------------	-------------------------------------	-----------------------------	---------------------	--------------

M12 connector · Output function 1 x normally open / closed programmable + 1 x analogue (4...20 / 20...4 mA, scalable) · DC PNP/NPN · Wiring diagram no. 18 · Connector groups 8, 10, 18, 20, 120, 124, 126, 128, 157

	Aseptoflex Vario	Display unit	-1...25	100	350	18...32	28	PG2793
---	------------------	--------------	---------	-----	-----	---------	----	--------

Type	Process connection	Display	Measuring range [bar]	P _{overload} max. [bar]	P _{bursting} min. [bar]	U _b DC [V]	Draw- ing no.	Order no.
M12 connector · Output function 1 x normally open / closed programmable + 1 x analogue (4...20 / 20...4 mA, scalable) · DC PNP/NPN · Wiring diagram no. 18 · Connector groups 8, 10, 18, 20, 120, 124, 126, 128, 157								
	Aseptoflex Vario	Display unit	-1...10	50	150	18...32	28	PG2794
	Aseptoflex Vario	Display unit	-1...4	30	100	18...32	28	PG2795
	Aseptoflex Vario	Display unit	-1...1	10	30	18...32	28	PG2799
	Aseptoflex Vario	Display unit	-0.124...2.5	20	50	18...32	28	PG2796
	Aseptoflex Vario	Display unit	-0.05...1	10	30	18...32	28	PG2797
	Aseptoflex Vario	Display unit	-0.0124...0.25	10	30	18...32	28	PG2798
	Aseptoflex Vario	Display unit	-0.005...0.1	4	30	18...32	28	PG2789
	Sealing cone G1 male	Display unit	-1...25	100	350	18...32	29	PG2893*
	Sealing cone G1 male	Display unit	-1...10	50	150	18...32	29	PG2894*
	Sealing cone G1 male	Display unit	-1...4	30	100	18...32	29	PG2895*
	Sealing cone G1 male	Display unit	-0.124...2.5	20	50	18...32	29	PG2896*
	Sealing cone G1 male	Display unit	-0.05...1	10	30	18...32	29	PG2897*
	Sealing cone G1 male	Display unit	-0.0124...0.25	10	30	18...32	29	PG2898*
	Sealing cone G1 male	Display unit	-1...1	10	30	18...32	29	PG2899*
	Sealing cone G1 male	Display unit	-0.005...0.1	4	30	18...32	29	PG2889*

* Attention: The unit must only be installed in a process connection for G1 sealing cone! The G1 male sealing cone of the unit is only suited for adapters with metal end stop!

PF sensors for hygienic and wet areas with switching and analogue outputs

Type	Process connection	Display	Measuring range [bar]	P _{overload} max. [bar]	P _{bursting} min. [bar]	U _b DC [V]	Draw- ing no.	Order no.
------	--------------------	---------	--------------------------	-------------------------------------	-------------------------------------	-----------------------------	---------------------	--------------



M12 connector · Output function 2 x normally open / closed programmable or 1 x normally open / closed programmable + 1 x analogue (4...20 mA / 0...10 V; scaleable 1:4) · Wiring diagram no. 21 · Connector groups 8, 10, 18, 20, 120, 124, 126, 128, 157

	G 3/4 A	Switching status	-1...25	100	200	20...30	30	PF2953
	G 3/4 A	Switching status	-0.5...10	50	150	20...30	30	PF2954
	G 3/4 A	Switching status	-0.13...2.5	20	50	20...30	30	PF2956
	G 3/4 A	Switching status	-0.05...1	10	30	20...30	30	PF2957

PL / PM sensors without display for hygienic and wet areas with analogue output

Type	Process connection	Display	Measuring range [bar]	P _{overload} max. [bar]	P _{bursting} min. [bar]	U _b DC [V]	Draw- ing no.	Order no.
------	--------------------	---------	--------------------------	-------------------------------------	-------------------------------------	-----------------------------	---------------------	--------------

M12 connector · Output function 4...20 mA analogue · 3-wire DC; 2-wire DC · Wiring diagram no. 22 · Connector groups 8, 10, 18, 20, 120, 124, 126, 128, 157

	Sealing cone G1 male	–	-1...100	200	650	14...30	31	PL2652
	Sealing cone G1 male	–	-1...25	100	350	14...30	32	PL2653
	Sealing cone G1 male	–	-0.5...10	50	150	14...30	32	PL2654
	Sealing cone G1 male	–	-0.13...2.5	20	50	14...30	32	PL2656
	Sealing cone G1 male	–	-0.05...1	10	30	14...30	32	PL2657
	Sealing cone G1 male	–	-0.0125...0.25	10	30	14...30	32	PL2658
	Sealing cone G1 male	–	-1...25	100	350	14...30	33	PM2653
	Sealing cone G1 male	–	-0.5...10	50	150	14...30	33	PM2654
	Sealing cone G1 male	–	-0.99...4	30	100	14...30	33	PM2655

Type	Process connection	Display	Measuring range [bar]	P _{overload} max. [bar]	P _{bursting} min. [bar]	U _b DC [V]	Drawing no.	Order no.
------	--------------------	---------	--------------------------	-------------------------------------	-------------------------------------	-----------------------------	-------------	-----------

M12 connector · Output function 4...20 mA analogue · 3-wire DC; 2-wire DC · Wiring diagram no. 22 · Connector groups 8, 10, 18, 20, 120, 124, 126, 128, 157

	Sealing cone G1 male	–	-0.13...2.5	20	50	14...30	33	PM2656
	Sealing cone G1 male	–	-0.05...1	10	30	14...30	33	PM2657
	Sealing cone G1 male	–	-0.0125...0.25	10	30	14...30	33	PM2658

PE sensors with display with 2 switching outputs or switching and analogue output

Type	Process connection	Display	Measuring range [bar]	P _{overload} max. [bar]	P _{bursting} min. [bar]	U _b DC [V]	Drawing no.	Order no.
------	--------------------	---------	--------------------------	-------------------------------------	-------------------------------------	-----------------------------	-------------	-----------



M12 connector · Output function 2 x normally open / closed programmable or 1 x normally open / closed programmable + 1 x normally closed (diagnostic function) · DC PNP/NPN · Wiring diagram no. 19 · Connector groups 8, 10, 18, 20, 120, 124, 126, 128, 157

	G ¼ I	Display unit	0...100	300	650	18...36	34	PE7002
	G ¼ I	Display unit	0...25	150	350	18...36	34	PE7003
	G ¼ I	Display unit	-1...10	75	150	18...36	34	PE7004
	G ¼ I	Display unit	0...2.5	20	50	18...36	34	PE7006
	G ¼ I	Display unit	-1...1	20	50	18...36	34	PE7009

M12 connector · Output function normally open / closed programmable; 4...20 mA or 0...10 V · DC PNP · Wiring diagram no. 17 · Connector groups 8, 10, 18, 20, 120, 124, 126, 128, 157

	G ¼ I	Display unit	0...400	600	1000	18...36	35	PE3000
	G ¼ I	Display unit	0...250	400	850	18...36	34	PE3001
	G ¼ I	Display unit	0...100	300	650	18...36	34	PE3002
	G ¼ I	Display unit	0...25	150	350	18...36	34	PE3003
	G ¼ I	Display unit	-1...10	75	150	18...36	34	PE3004





Process sensors

Type	Process connection	Display	Measuring range [bar]	P _{overload} max. [bar]	P _{bursting} min. [bar]	U _b DC [V]	Draw- ing no.	Order no.
M12 connector · Output function normally open / closed programmable; 4...20 mA or 0...10 V · DC PNP · Wiring diagram no. 17 · Connector groups 8, 10, 18, 20, 120, 124, 126, 128, 157								
	G 1/4 I	Display unit	0...2.5	20	50	18...36	34	PE3006
	G 1/4 I	Display unit	-1...0	10	30	18...36	34	PE3029
	G 1/4 I	Display unit	-1...1	20	50	18...36	34	PE3009

Fixing components for pressure sensors

Type	Description	Order no.
	Angle bracket · Housing materials: PA66-	E30421
	Mounting clamp · Ø 34 mm · Housing materials: PBT	E10017
	Mounting clamp · Ø 34 mm · Housing materials: PA	E10193

Accessories and software

Type	Description	Order no.
	Protective cover · for fluid sensors with M12 connector · Housing materials: Polypropylene homopolymer	E30420
	Memory plug · Parameter memory for IO-Link sensors · Storage capacity: 2 Kbytes · Housing materials: PA PACM 12 / PET / sealing: FPM / nut: stainless steel 316L / 1.4404 / connector: TPU	E30398
	Teach button · for sensors PP0xE, PP052x, PP755x · for memory plug (E30398) · 0.9 m · Housing materials: stainless steel / PA / PMMA	E30405
	Programming/ display unit · for EPS and IO-Link sensors · Connector · Housing materials: stainless steel 316L / 1.4404 / PC copolymer / PBT / FPM	PP2001
	Protective cover · with lead seal option · for pressure sensors type PK · for temperature sensors type TK · for vibration sensors type VK · Housing materials: PP transparent	E30094

Type	Description	Order no.
	IO-Link interface · for parameter setting and analysis of units with max. 65 mA current consumption · Supported communication protocols: IO-Link (4800 and 38400 bits/s) EPS protocol (19200 bits/s) · for operation with FDT framework software "ifm Container" or software "LINERECORDER SENSOR"	E30396
	USB IO-Link master · for parameter setting and analysis of units · Supported communication protocols: IO-Link (4.8, 38.4 and 230 Kbits/s) · for operation with FDT framework software "ifm Container" or software "LINERECORDER SENSOR"	E30390
	LINERECORDER SENSOR · Version 4.0.0 · Software for clear online and offline parameter setting of IO-Link sensors via USB adapter · Use via USB connection cable (drivers are supplied): E30396 IO-Link interface or E30390 IO-Link master (note the respective data sheet) · IODD import and update from ifm's homepage · Reading of IODDs via storage media · Automatic sensor identification · Graphic representation of the process values and history incl. export function · Documentation and archiving · Transferable parameter sets · Full memory plug support for IO-Link 1.1	QA0001
	Syphon · G ¼ · Housing materials: steel	E30140
	Syphon · G ½ · Housing materials: steel	E30141
	Cable clamp fastener · for submersible pressure transmitter PS3 · Housing materials: steel / plastics	E30399
	Filter element · for submersible pressure transmitter PS3 · for fixing on the capillary tube	E30400
	Splitter box · with ventilation and terminal block · for submersible pressure transmitter PS3 · Housing materials: plastics	E30401
	Additional weight · for submersible pressure transmitter PS3 · Housing materials: stainless steel 316Ti / 1.4571	E30402
	DIN rail clip · Housing materials: stainless steel	E37340
	Connector · QS-G 1/8-6 · with hexagonal socket 4 mm a/f · for tube with Ø 6 mm · Housing materials: steel / PBT / Brass / aluminium	E30076
	Connector · QS-G 1/8-8 · with hexagonal socket 5 mm a/f · for tube with Ø 8 mm · Housing materials: steel / PBT / Brass / aluminium	E30077

Certificates

Description	Order no.
-------------	-----------

Factory calibration certificate for pressure sensors and flow sensors · Measurement points, pressure sensors: 6 measurement points in 20% steps of the final value of the measuring range (acc. to ISO 9001) · Measurement points, flow sensors: 3 or 4 measurement points, distances defined depending on the measuring range (acc. to ISO 9001)













ZC0004





Description	Order no.
-------------	-----------

DAkKS calibration certificate for pressure sensors · Number of measuring points: 11-point DAkKS calibration · Measurement points: in 10 % steps of the measuring range (according to directive DAkKS-DKD-R 6-1) · Minimum measurement uncertainty [bar]: 20 µbar...140 mbar (depending on the reference pressure)

ZC0005

Adapters and accessories for adapters











Type	Description	Order no.
	Adapter · R1/8 - R1/8 · rotatable · Housing materials: Brass nickel-plated	E37350
	T-pipe mounting set · G1/2 · with reducer G1/2 - G1/8, adapter R1/8 - R1/8 rotatable, seal G1/2 · Housing materials: Brass nickel-plated	E37360
	Flange adapter · G ¼ · Hole spacing · 31.1 mm · Housing materials: sealing: NBR, acrylonitrile-butadiene-rubber / flange: aluminium / hollow screw: Brass	E30003
	Adapter · G ¼ · G ½ · Housing materials: stainless steel / sealing: FPM	E30000
	Adapter · G ¼ A - G ¼ A · Housing materials: 1.4404	E30143
	Adapter · G ¼ · M20 x 1.5 · Housing materials: stainless steel / FPM	E30010
	Adapter · G ¼ · G ½ · Housing materials: stainless steel / sealing: FPM	E30050
	Adapter · ¼" NPT - G ¼ · Housing materials: stainless steel 316Ti / 1.4571	E30058
	Adapter · ¼" NPT - G ½ · Housing materials: stainless steel 316Ti / 1.4571	E30059
	Adapter · G ¼ · DN16 · G¼ small flange DIN 28403 DN16 · Housing materials: stainless steel	E30065
	Flange adapter · G ¼ · for pressure sensors type PP7 / type PK · Housing materials: stainless steel / O-ring: NBR	E30063
	Adapter · G 1 - G ½ · Housing materials: stainless steel 316L / 1.4404 / sealing: FPM	E30116



Type	Description	Order no.
	Adapter · G ¼ - G ½ · Housing materials: stainless steel 316Ti / 1.4571 / sealing: FPM	E30135
	Damping screw · for pressure sensors with M5 internal thread	E30057
	O-ring · 24 x 2 · Housing materials: FKM FDA compliant	E30123
	Sealing ring · for Aseptoflex Vario adapter · Housing materials: PEEK FDA compliant	E30124

Flange adapters

Type	Description	Order no.
Clamp adapter · 1-1.5" · Aseptoflex Vario		
	Clamp adapter · Clamp · 1-1.5" · ISO 2852 · for units with Aseptoflex Vario adapter · Sealing by sealing ring · Housing materials: stainless steel 316L / 1.4435	E33201
	Clamp adapter · with leakage port · Clamp · 1-1.5" · with sealing ring · ISO 2852 · for units with Aseptoflex Vario adapter · Housing materials: stainless steel 316L / 1.4435	E33208
	Clamp adapter · Clamp · 1-1.5" · ISO 2852 · for units with Aseptoflex Vario adapter · Metal to metal seal · Housing materials: stainless steel 316L / 1.4435	E33701
Clamp adapter · 2" · Aseptoflex Vario		
	Clamp adapter · Clamp · 2" · ISO 2852 · for units with Aseptoflex Vario adapter · Sealing by sealing ring · Housing materials: stainless steel 316L / 1.4435	E33202
	Aseptoflex Vario adapter · with leakage port · Clamp · 2" · with sealing ring · ISO 2852 · for units with Aseptoflex Vario adapter · Housing materials: stainless steel 316L / 1.4435	E33209
	Clamp adapter · Clamp · 2" · ISO 2852 · for units with Aseptoflex Vario adapter · Metal to metal seal · Housing materials: stainless steel 316L / 1.4435	E33702
Varivent Adapter · Type F, DN25 (1"), D = 50 · Aseptoflex Vario		
	Clamp adapter · Varivent Adapter · Varivent type F · DN25 (1"), D = 50 · for units with Aseptoflex Vario adapter · Sealing by sealing ring · Housing materials: stainless steel 316L / 1.4435	E33221
	Clamp adapter · Varivent Adapter · with leakage port · Varivent type F · DN25 (1"), D = 50 · for units with Aseptoflex Vario adapter · Sealing by sealing ring · Housing materials: stainless steel 316L / 1.4435	E33228

Type	Description	Order no.
Varivent Adapter · Type F, DN25 (1"), D = 50 · Aseptoflex Vario		
	Clamp adapter · Varivent Adapter · Varivent type F · DN25 (1"), D = 50 · for units with Aseptoflex Vario adapter · Metal to metal seal · Housing materials: stainless steel 316L / 1.4435	E33721
Varivent Adapter · Type N, DN40...DN150 (1.5...6"), D = 68 · Aseptoflex Vario		
	Clamp adapter · Varivent Adapter · Varivent type N · DN40...DN150 (1.5...6"), D = 68 · for units with Aseptoflex Vario adapter · Sealing by sealing ring · Housing materials: stainless steel 316L / 1.4435	E33222
	Clamp adapter · Varivent Adapter · with leakage port · Varivent type N · DN40 (1.5"), D = 68 · for units with Aseptoflex Vario adapter · Sealing by sealing ring · Housing materials: stainless steel 316L / 1.4435	E33229
	Clamp adapter · Varivent Adapter · Varivent type N · DN40...DN150 (1.5...6"), D = 68 · for units with Aseptoflex Vario adapter · Metal to metal seal · Housing materials: stainless steel 316L / 1.4435	E33722
Hygienic pipe fitting · DN32 (1.25") · Aseptoflex Vario		
	Pipe fitting · Hygienic pipe fitting · Hygienic pipe fitting · DN32 (1.25") · DIN 11851 · for units with Aseptoflex Vario adapter · Sealing by sealing ring · Housing materials: stainless steel 316L / 1.4435	E33211
	Pipe fitting · Hygienic pipe fitting · Hygienic pipe fitting · DN32 (1.25") · DIN 11851 · for units with Aseptoflex Vario adapter · Metal to metal seal · Housing materials: stainless steel 316L / 1.4435	E33711
Hygienic pipe fitting · DN40 (1.5") · Aseptoflex Vario		
	Pipe fitting · Hygienic pipe fitting · Hygienic pipe fitting · DN40 (1.5") · DIN 11851 · for units with Aseptoflex Vario adapter · Sealing by sealing ring · Housing materials: stainless steel 316L / 1.4435	E33212
	Pipe fitting · Hygienic pipe fitting · Hygienic pipe fitting · DN40 (1.5") · DIN 11851 · for units with Aseptoflex Vario adapter · Metal to metal seal · Housing materials: stainless steel 316L / 1.4435	E33712
Hygienic pipe fitting · DN50 (2") · Aseptoflex Vario		
	Pipe fitting · Hygienic pipe fitting · Hygienic pipe fitting · DN50 (2") · DIN 11851 · for units with Aseptoflex Vario adapter · Sealing by sealing ring · Housing materials: stainless steel 316L / 1.4435	E33213
	Pipe fitting · Hygienic pipe fitting · Hygienic pipe fitting · DN50 (2") · DIN 11851 · for units with Aseptoflex Vario adapter · Metal to metal seal · Housing materials: stainless steel 316L / 1.4435	E33713
SMS pipe fitting · DN40 (1.5") · Aseptoflex Vario		
	Pipe fitting · SMS pipe fitting · DN40 (1.5") · SMS · for units with Aseptoflex Vario adapter · Metal to metal seal · Housing materials: stainless steel 316L / 1.4435	E33731
SMS pipe fitting · DN50 (2") · Aseptoflex Vario		
	Pipe fitting · SMS pipe fitting · DN50 (2") · SMS · for units with Aseptoflex Vario adapter · Metal to metal seal · Housing materials: stainless steel 316L / 1.4435	E33732

Type	Description	Order no.
DRD adapter · D65 · Aseptoflex Vario		
	Flange adapter · DRD adapter · flange · DRD · D = 65 · for units with Aseptoflex Vario adapter · Sealing by sealing ring · Housing materials: stainless steel 316L / 1.4435	E33242
universal process adapter · Rd52 · Aseptoflex Vario		
	Pipe fitting · universal process adapter · for units with Aseptoflex Vario adapter · Sealing by sealing ring · Housing materials: stainless steel 316L / 1.4435	E33340
Welding adapter · D50 · Aseptoflex Vario		
	Welding adapter · Ø 50 mm · for units with Aseptoflex Vario adapter · Sealing by sealing ring · Housing materials: stainless steel 316L / 1.4435	E30122
	Welding adapter · Ø 50 mm · with leakage port · for units with Aseptoflex Vario adapter · Sealing by sealing ring · Housing materials: stainless steel 316L / 1.4435	E30130
Aseptoflex Vario · Aseptoflex Vario		
	sealing plug · Aseptoflex Vario · Housing materials: adapter: stainless steel 316L / 1.4435 / sealing ring: FKM	E30128
Clamp adapter · 1-1.5" · G 1		
	Clamp adapter · Clamp · 1-1.5" · ISO 2852 · for units with G 1 adaptation · Housing materials: stainless steel 316L / 1.4435	E33601
Hygienic pipe fitting · DN40 (1.5") · G 1		
	Pipe fitting · Hygienic pipe fitting · Hygienic pipe fitting · DN40 (1.5") · DIN 11851 · for units with G 1 adaptation · Housing materials: stainless steel 316L / 1.4435	E33612
Welding adapter · D50 · G 1		
	Welding adapter · G 1 - Ø 50 mm · Housing materials: stainless steel 316L / 1.4404	E30013
	Welding adapter · G 1 - Ø 50 mm · Housing materials: stainless steel 316L / 1.4404 / O-ring: FKM / O-ring: EPDM	E30072
G 1		
	sealing plug · G 1 · Housing materials: high-grade stainless steel	E30070

Type	Description	Order no.
Welding adapter · D50 · G ¾		
	Welding adapter · G ¾ · Ø 50 mm · Housing materials: stainless steel 316L / 1.4404	E30009
G ¾		
	sealing plug · G ¾ · Housing materials: high-grade stainless steel	E30071

Wiring diagrams

Core colours

- BK black
- BN brown
- BU blue
- WH white
- GY grey
- GN green

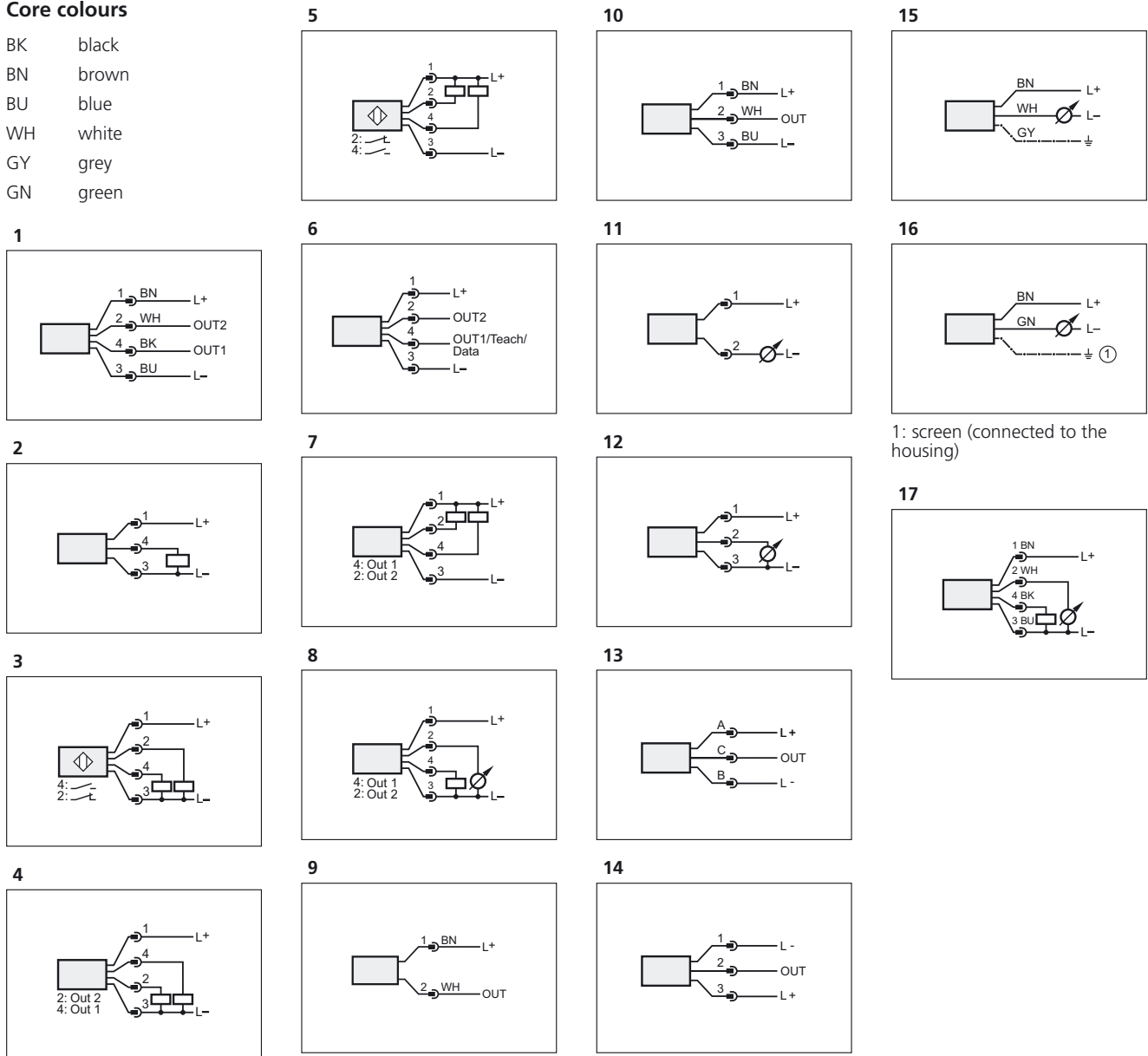

1: screen (connected to the housing)

Wiring diagrams

18

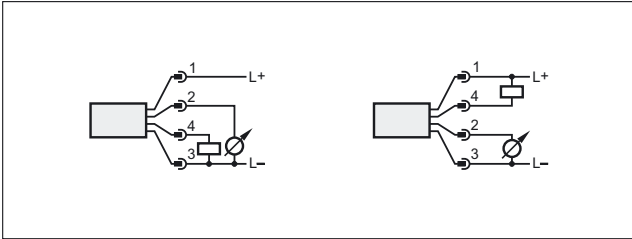

19

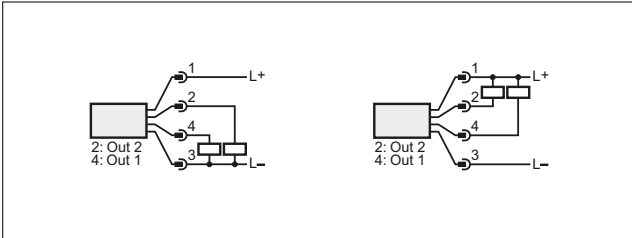

20

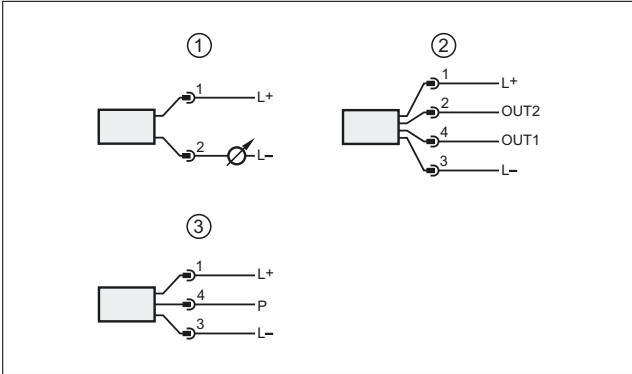

1: connection for 2-wire operation, 2: connection for 3-wire operation, 3: connection for IO-Link parameter setting (P = communication via IO-Link)

21

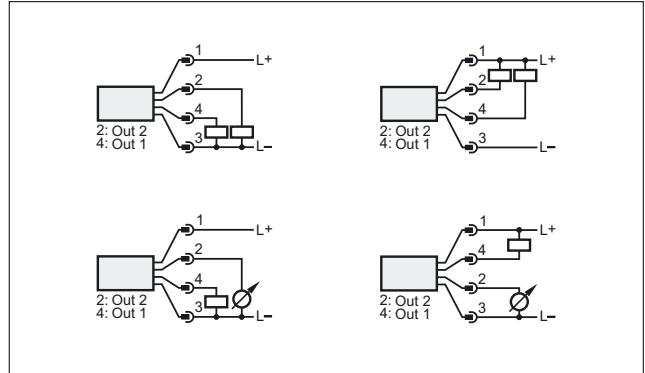

22

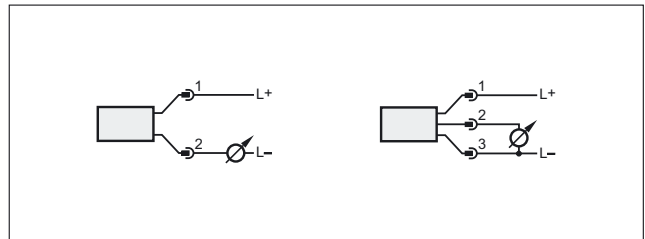

Scale drawings / drawing no. – CAD download: www.ifm.com

1

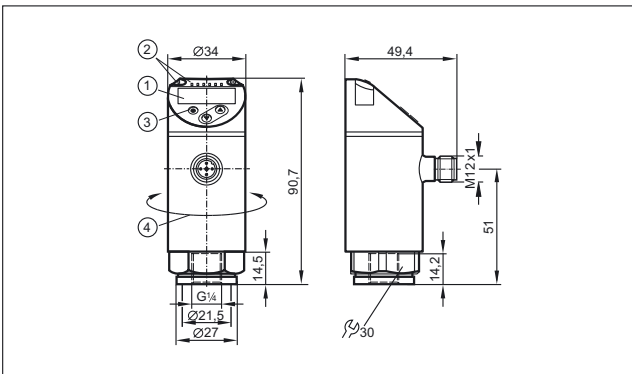

1: 4-digit alphanumeric display / alternating indication of red and green, 2: LEDs (display unit / switching status), 3: Programming button, 4: Upper part of the housing can be rotated by 345°

2

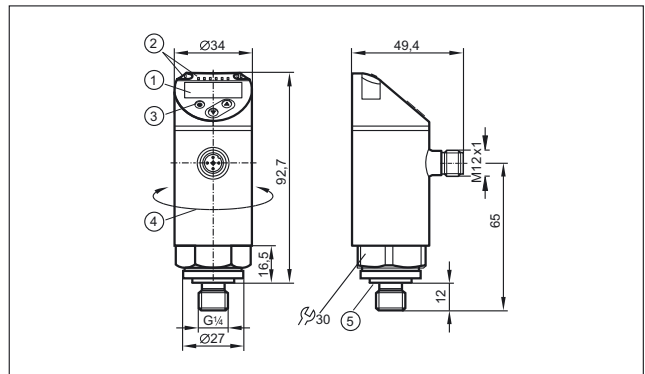

1: 4-digit alphanumeric display / alternating indication of red and green, 2: LEDs (display unit / switching status), 3: Programming button, 4: Upper part of the housing can be rotated by 345°, 5: sealing FKM / DIN 3869

Scale drawings / drawing no. – CAD download: www.ifm.com

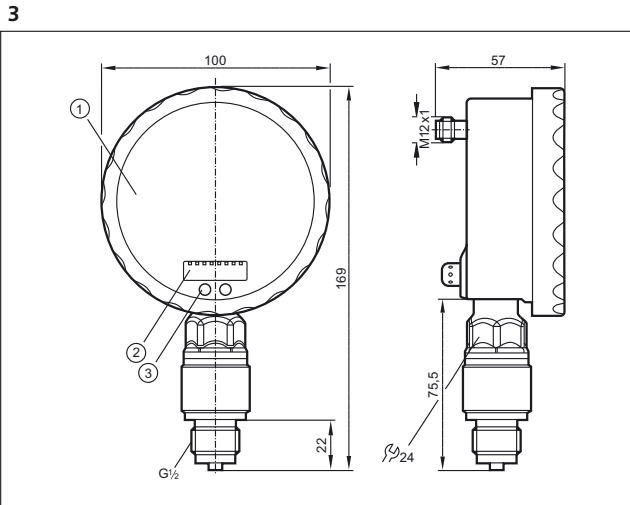

1: Analogue display, 2: 4-digit alphanumeric display, 3: Touch button (programming button)

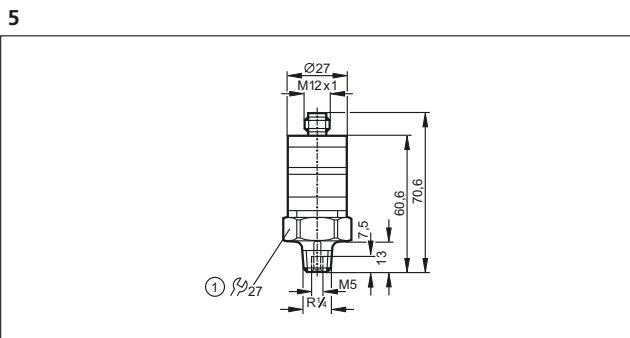
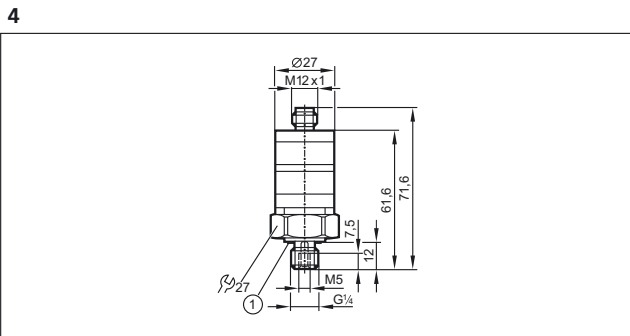

1: tightening torque 25 Nm

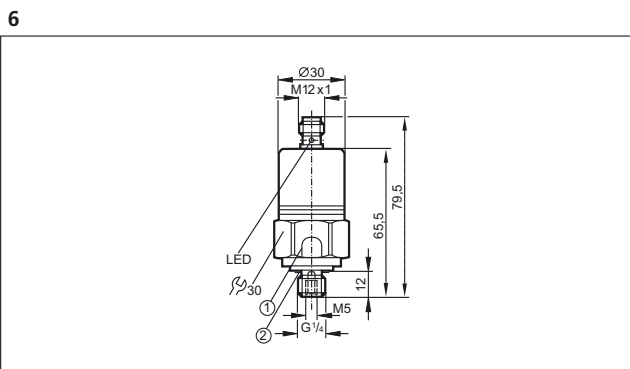

1: Pressure relief mechanism, No mechanical force must be exerted on the pressure relief mechanism., 2: sealing FPM / DIN 3869-14

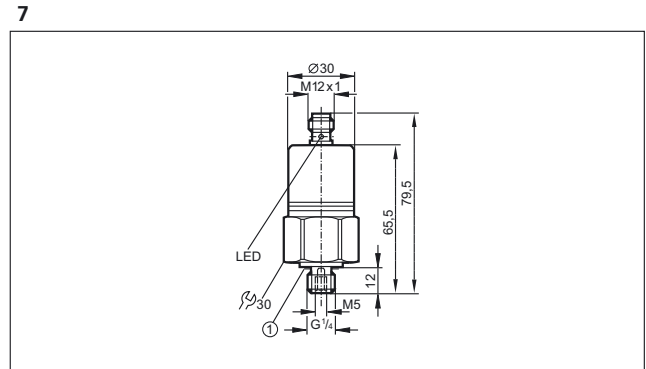

1: sealing FPM / DIN 3869-14

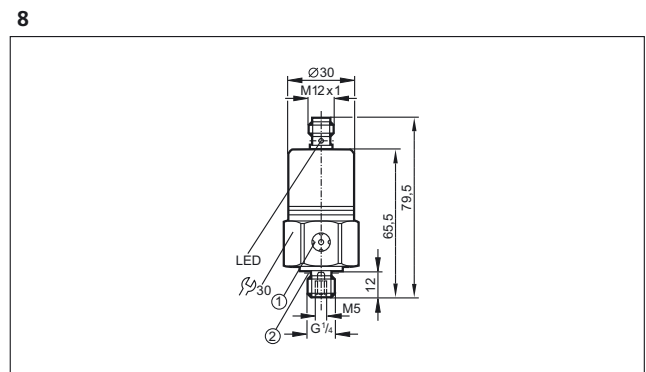

1: ventilation, 2: sealing FPM / DIN 3869-14

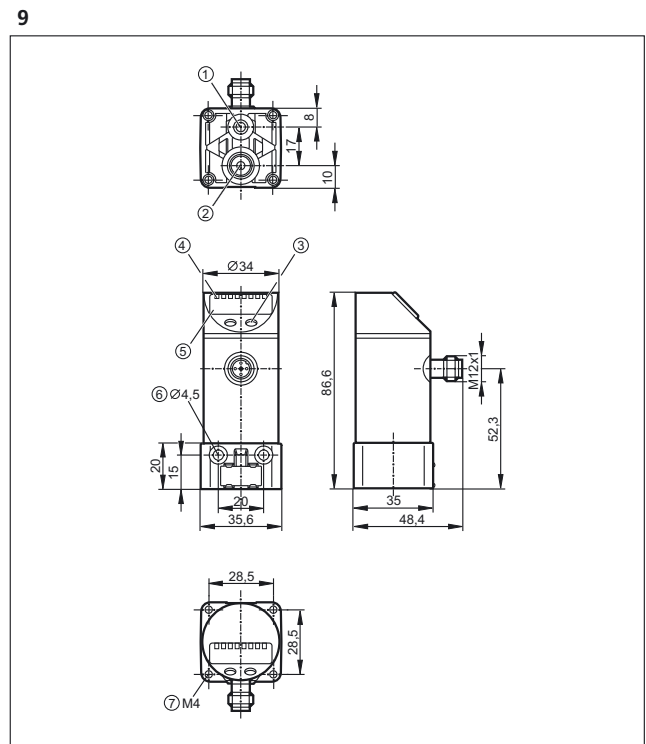

1: ventilation connection M5; max. tightening torque 2.5 Nm, 2: main pressure connection G 1/8; tightening torque max. 8 Nm, 3: Programming button, 4: LEDs (display unit / switching status), 5: 4-digit alphanumeric display, 6: for mounting screw M4; max. tightening torque 2.5 Nm, 7: for mounting screw M4; max. tightening torque 2.5 Nm

Scale drawings / drawing no. – CAD download: www.ifm.com

10

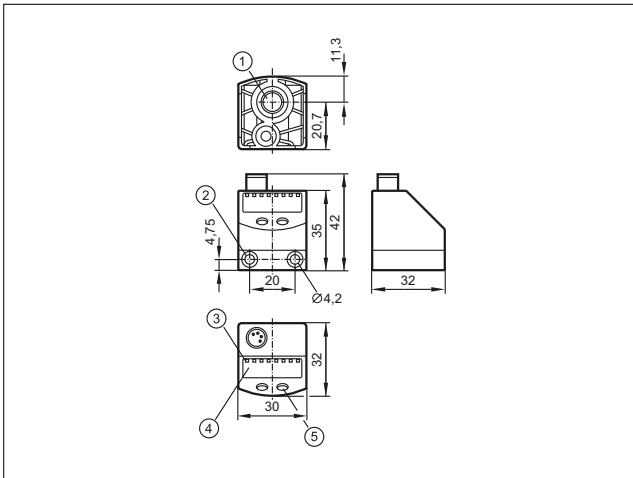

1: main pressure connection G 1/8; tightening torque max. 8 Nm, thread length max: 7.5 mm, 2: for mounting screw M4; max. tightening torque 2.5 Nm, 3: LEDs (display unit / switching status), 4: 4-digit alphanumeric display, 5: Programming button

11

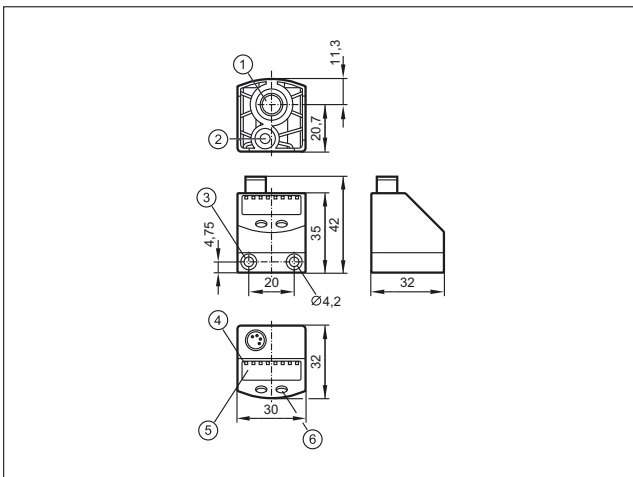

1: Main pressure connection G 1/8; Tightening torque max. 8 Nm, insertion depth max. 7.5 mm, 2: Auxiliary pressure connection M5; Tightening torque max. 2.5 Nm, insertion depth max. 7.5 mm, 3: for mounting screw M4; max. tightening torque 2.5 Nm, 4: LEDs (display unit / switching status), 5: 4-digit alphanumeric display, 6: Programming button

12

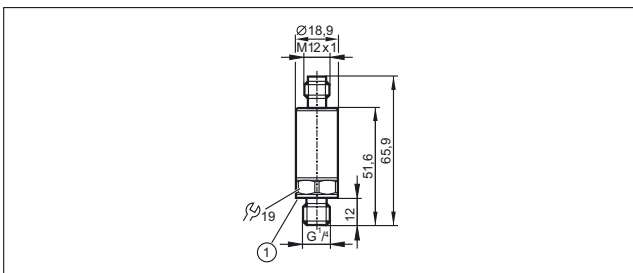

1: FKM seal / DIN 3869-14

13

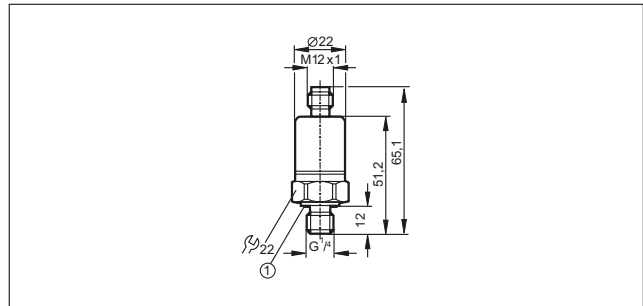

1: FKM seal / DIN 3869-14, tightening torque 25 Nm

14

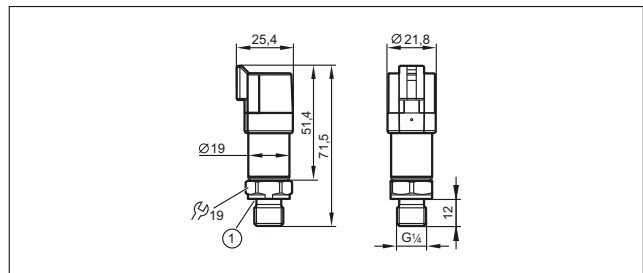

1: sealing FKM / DIN 3869

15

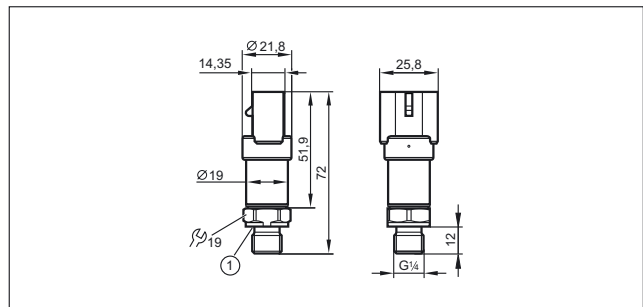

1: sealing FKM / DIN 3869

16

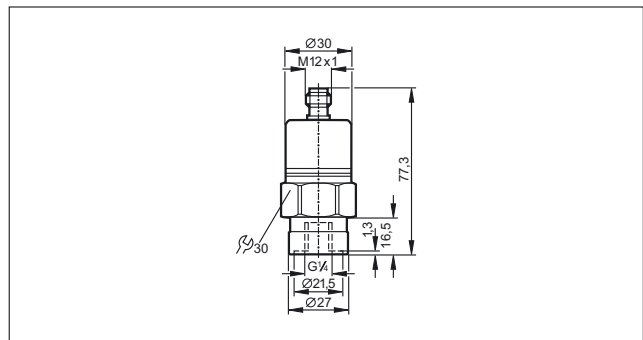

Scale drawings / drawing no. – CAD download: www.ifm.com

17

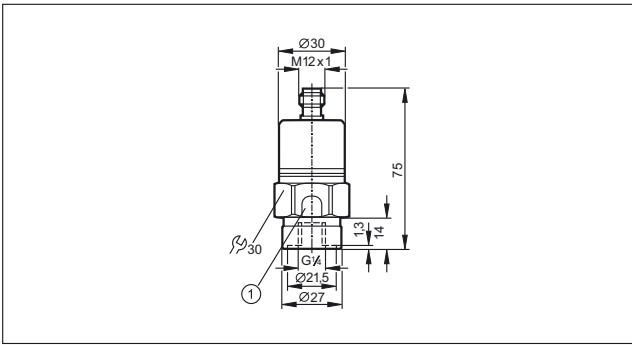

1: Pressure relief mechanism, No mechanical force must be exerted on the pressure relief mechanism.

18

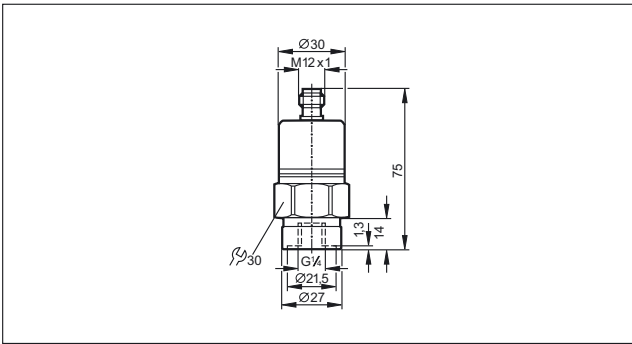

19

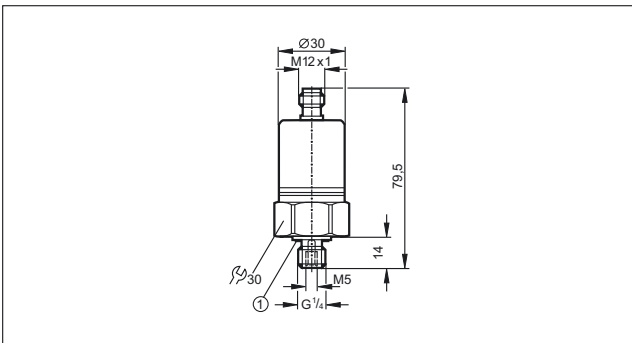

1: sealing FPM / DIN 3869-14

20

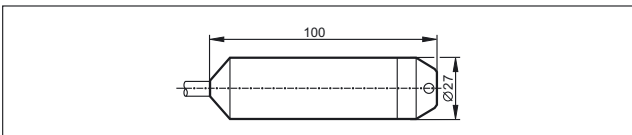

21

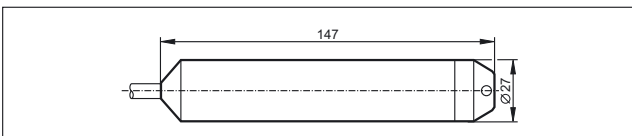

22

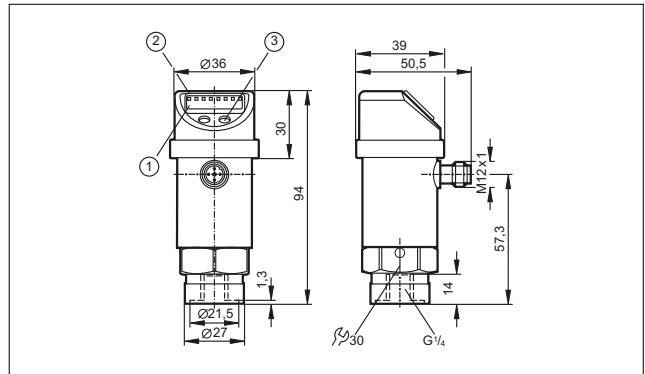

1: 4-digit alphanumeric display, 2: LEDs (display unit / switching status), 3: Programming button

23

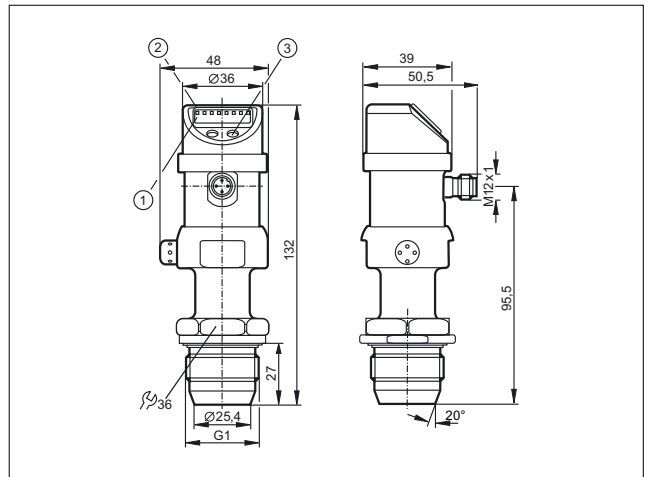

1: 4-digit alphanumeric display, 2: LEDs, 3: Programming button

24

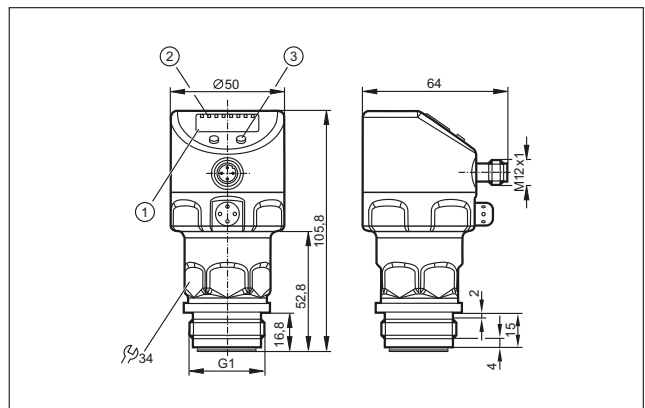

1: 4-digit alphanumeric display, 2: LEDs, 3: Programming button

Scale drawings / drawing no. – CAD download: www.ifm.com

25

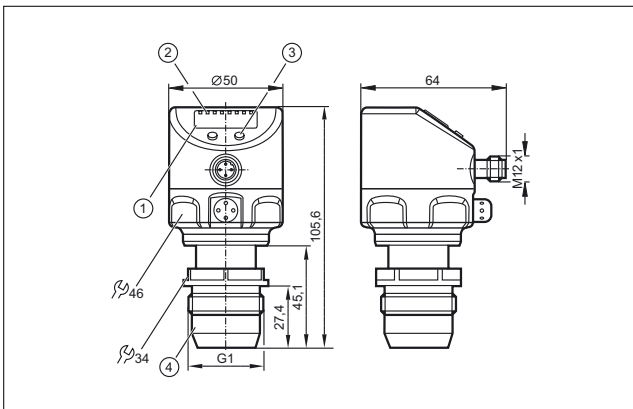

1: 4-digit alphanumeric display, 2: LEDs, 3: Programming button, 4: Sealing cone G1 male, Attention: The unit must only be installed in a process connection for G1 sealing cone! The G1 male sealing cone of the unit is only suited for adapters with metal end stop!

26

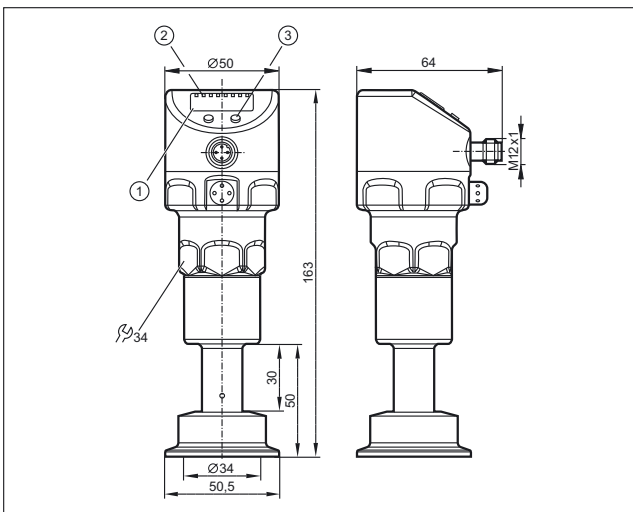

1: 4-digit alphanumeric display, 2: LEDs, 3: Programming button

27

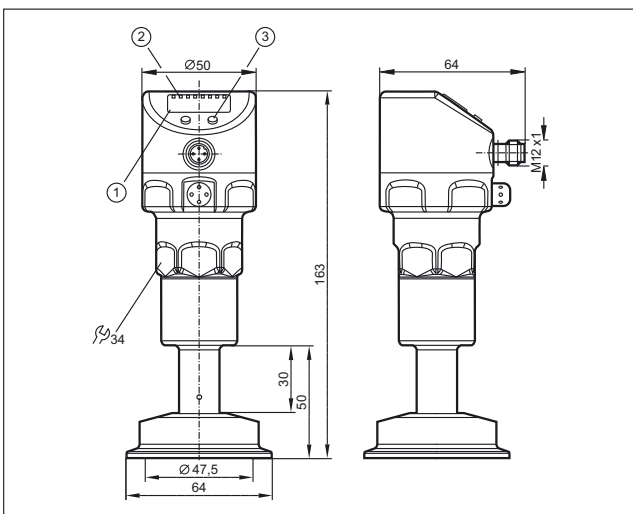

28

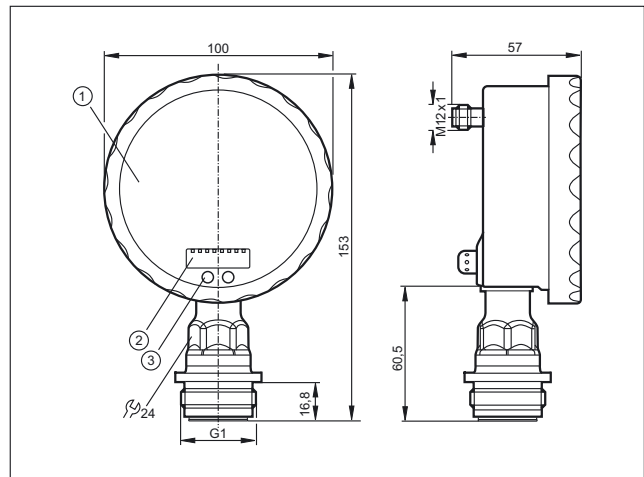

1: Analogue display, 2: 4-digit alphanumeric display, 3: Programming button

29

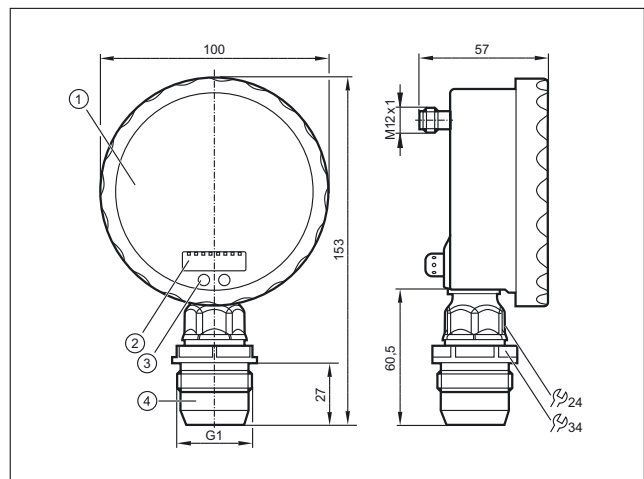

1: Analogue display, 2: 4-digit alphanumeric display, 3: Touch button (programming button), 4: Sealing cone G1 male, Attention: The unit must only be installed in a process connection for G1 sealing cone! The G1 male sealing cone of the unit is only suited for adapters with metal end stop!

30

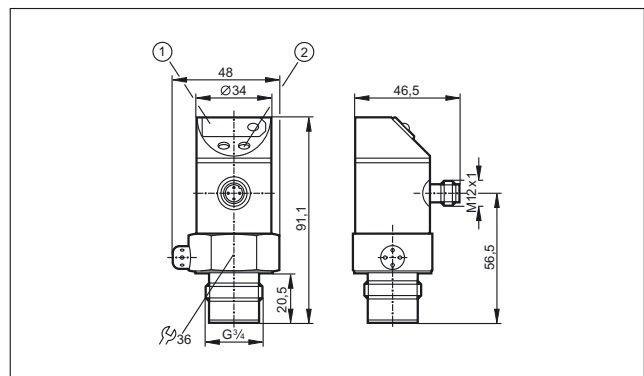

1: 7-segment LED display, 2: Programming button

Scale drawings / drawing no. – CAD download: www.ifm.com

31

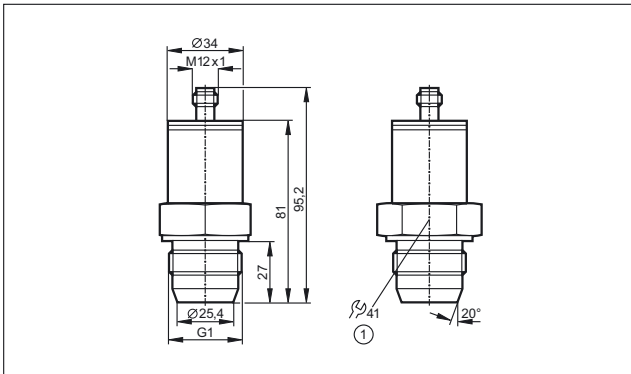

1: tightening torque 20 Nm

32

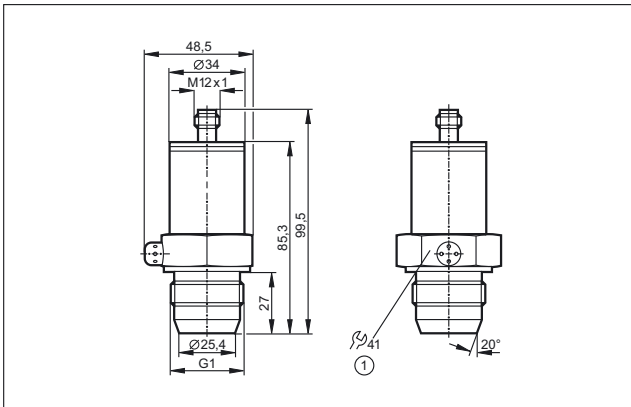

1: tightening torque 20 Nm

33

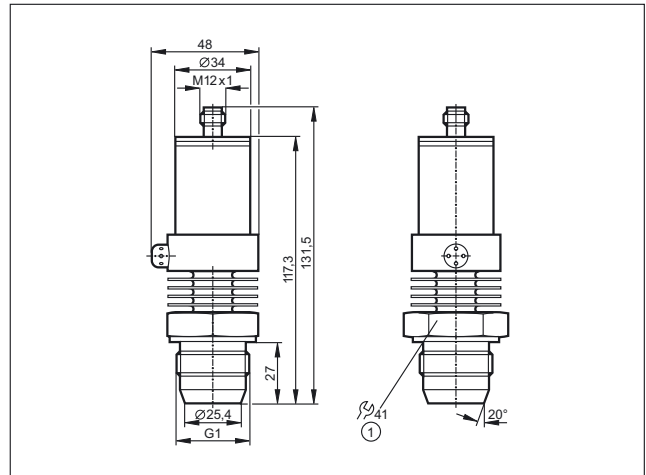

1: tightening torque 20 Nm

34

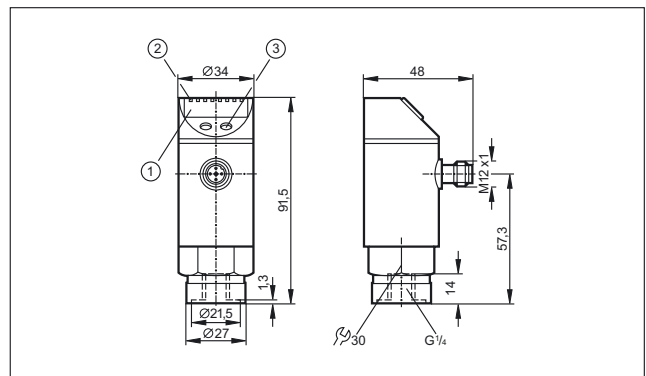

1: 4-digit alphanumeric display, 2: LEDs (display unit / switching status), 3: Programming button

35

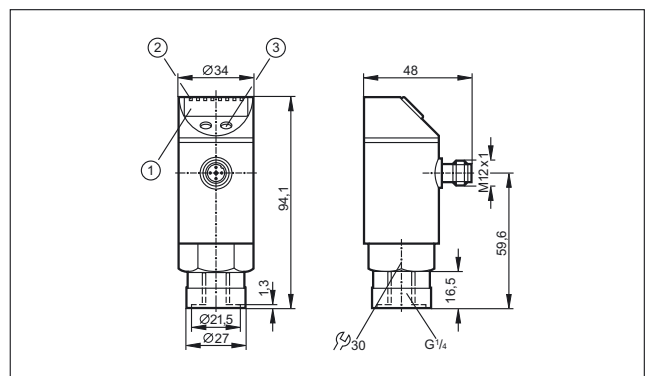

1: 4-digit alphanumeric display, 2: LEDs (display unit / switching status), 3: Programming button





- For liquids and gases
- Special versions for food applications and hazardous areas
- Optional fittings for variable process connection
- Flow monitoring also for aggressive media

Flow sensors

In almost all fields of process and plant engineering liquids or gases are used for coolant and lubricant supply of machines and units, ventilation of installations and buildings and the processing of products. In case of no flow of these media considerable damage and downtime may result. Thus it is very important to monitor these media. In modern installations electronic flow monitors are used for this purpose. They work without wear and tear and without mechanical components. This guarantees reliable monitoring even in case of difficult media over a long period.

Operating principle

Electronic flow sensors from ifm operate with different measurement techniques. They meet all requirements from a simple monitoring function to the exact detection of flow quantities.

Harmonised operating menus ensure that operators who use different flow sensors can quickly and precisely carry out settings on the sensors. Some flow sensors feature an integrated temperature monitor which makes an additional measuring point unnecessary. This enables to control processes in the optimum operating status especially with regard to energy savings.

Analogue, binary and pulse outputs offer various possibilities to process the measured data. Due to the flexible programming by means of pushbuttons the flow sensors can be adapted to different conditions. The sensors are mounted via adapters.



Monitoring very small flow rates: Flow monitor with flow adapter.

Optimised consumption of compressed air.





System overview	Page
Flow meters with integrated temperature measurement	475 - 476
Magnetic-inductive flow meters with integrated temperature measurement (sealing material FKM)	476 - 477
Magnetic-inductive flow meters with integrated temperature monitoring (sealing material EPDM) KTW / W270 approval	477 - 478
Magnetic-inductive flow meters (sealing material FKM)	478
Compact housings for adapters for flow monitoring	478 - 479
Compact housings can be configured for T-pieces for flow monitoring	479
Compact housings for adapters for flow monitoring, Hastelloy sensor tip	479
Compact housings for adapters for flow monitoring, titanium sensor tip	480
Compact designs for adapter with flow and temperature monitoring	480
Compact housings for adapters with ATEX approval group II, category 3D / 3G	480
Compact housings for adapters with Germanischer Lloyd (GL) approval	480
Compact housings for adapters for hygienic and wet areas	481
Mechatronic flow sensors for machine tools	481
Mechatronic flow sensors with display	481 - 482
Mechatronic flow sensors for liquids	482 - 483
Mechatronic flow sensors for high temperatures	483 - 484
Flow sensors for connection to control monitors, industrial applications	484
Flow sensors for connection to control monitors, industrial applications, titanium housing	484 - 485
Flow sensors for connection to control monitors for hygienic and wet areas	485
Flow sensors for connection to control monitors for aggressive media, ceramic housing	485 - 486
Flow sensors for connection to control monitors with ATEX approval	486
Flow sensors for connection to control monitors with ATEX approval, ceramic housing	487
Flow sensors for connection to control monitors with ATEX approval 2G	487
Air flow monitors	487
Compressed air meters	488
Compressed air meter for special gases	488
Ultrasonic flow meters for liquids (water, glycol solutions, oils)	489
Accessories for flow sensors and control monitors	489 - 491
Flange adapters for flow sensors	491 - 492
Accessories for airflow monitors	492
Accessories for flow meters	492 - 494
Grounding clamps for magnetic-inductive flow meters	494

<i>System overview</i>	<i>Page</i>
Wiring diagrams	494 - 495
Scale drawings / drawing no. – CAD download: www.ifm.com	495 - 505



Flow meters with integrated temperature measurement

Type	Process connection	Measuring range [l/min]	Medium temperature [°C]	Pressure rating [bar]	Response time [s]	U _b [V]	Drawing no.	Order no.
------	--------------------	----------------------------	----------------------------	--------------------------	----------------------	-----------------------	-------------	-----------

Output function OUT1: normally open / normally closed programmable or frequency or IO-Link OUT2: normally open / normally closed programmable or frequency · Wiring diagram no. 1 · Connector groups 8, 10, 18, 20, 120, 124, 126, 128, 157

	G ½	1...20	-10...90	12	< 1	18...30	1	SV4200
	Rc ½	1...20	-10...90	12	< 1	18...30	1	SV4500
	G ½	2...40	-10...90	12	< 1	18...30	1	SV5200
	Rc ½	2...40	-10...90	12	< 1	18...30	1	SV5500
	G ¾	5...100	-10...90	12	< 1	18...30	2	SV7200
	Rc ¾	5...100	-10...90	12	< 1	18...30	2	SV7500





Output function OUT1 = analogue signal temperature OUT2 = analogue signal flow · Wiring diagram no. 1 · Connector groups 8, 10, 18, 20, 120, 124, 126, 128, 157

	G ½	1...20	-10...90	12	< 1	18...30	3	SV4204
	Rc ½	1...20	-10...90	12	< 1	18...30	3	SV4504
	G ½	2...40	-10...90	12	< 1	18...30	3	SV5204
	Rc ½	2...40	-10...90	12	< 1	18...30	3	SV5504
	G ¾	5...100	-10...90	12	< 1	18...30	4	SV7204
	Rc ¾	5...100	-10...90	12	< 1	18...30	4	SV7504



Output function analogue · Wiring diagram no. 2 · Connector groups 8, 10, 18, 20, 120, 124, 126, 128, 157

	G ½	0.5...10	-40...100	12	< 0.5	8...33	5	SV3050
	G ½	0.5...10	-40...100	12	< 0.5	8...33	5	SV3150

Process sensors



Type	Process connection	Measuring range [l/min]	Medium temperature [°C]	Pressure rating [bar]	Response time [s]	U _b [V]	Draw- ing no.	Order no.
Output function analogue · Wiring diagram no. 3 · Connector groups 8, 10, 18, 20, 120, 124, 126, 128, 157								
	G ½	0.9...15	-40...100	12	< 0.5	8...33	6	SV4050
	G ½	0.9...15	-40...100	12	< 0.5	8...33	6	SV4150
	G ¾	1.8...32	-40...100	12	< 0.5	8...33	7	SV5050
	G ¾	1.8...32	-40...100	12	< 0.5	8...33	7	SV5150
	G ¾	3.5...50	-40...100	12	< 0.5	8...33	8	SV6050
	G ¾	3.5...50	-40...100	12	< 0.5	8...33	8	SV6150
	G1	5.0...85	-40...100	12	< 0.5	8...33	9	SV7050
	G1	5.0...85	-40...100	12	< 0.5	8...33	9	SV7150
	G 1¼	9...150	-40...100	12	< 0.5	8...33	10	SV8050
	G 1¼	9...150	-40...100	12	< 0.5	8...33	10	SV8150

Magnetic-inductive flow meters with integrated temperature measurement (sealing material FKM)

Type	Process connection	Measuring range [l/min]	Medium temperature [°C]	Pressure rating [bar]	Response time [s]	U _b [V]	Draw- ing no.	Order no.
Output function OUT1: normally open / closed programmable or pulse OUT2: normally open / closed programmable or analogue (4...20 mA / 0...10 V, scaleable) · Wiring diagram no. 1 · Connector groups 8, 10, 18, 20, 120, 124, 126, 128, 157								
	G½	0.10...25.00	-10...70	16	< 0.150	19...30	11	SM6000
	G¾	0.2...50.0	-10...70	16	< 0.150	19...30	12	SM7000
	G1	0.2...100.0	-10...70	16	< 0.150	19...30	13	SM8000

Type	Process connection	Measuring range [l/min]	Medium temperature [°C]	Pressure rating [bar]	Response time [s]	U _b [V]	Drawing no.	Order no.
------	--------------------	----------------------------	----------------------------	--------------------------	----------------------	-----------------------	-------------	-----------

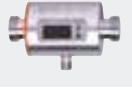
Output function 2 x analogue (4...20 mA scalable) · Wiring diagram no. 1 · Connector groups 8, 10, 18, 20, 120, 124, 126, 128, 157

	G½	0.1...25.00	-10...70	16	< 0.150	20...30	11	SM6004
	G¾	0.2...50.0	-10...70	16	< 0.150	20...30	12	SM7004
	G1	0.2...100.0	-10...70	16	< 0.150	20...30	13	SM8004

Output function OUT1: normally open / normally closed programmable or pulse or frequency or empty pipe detection or IO-Link
 OUT2: normally open / normally closed programmable or analogue (4...20 mA; 0...10 V, scalable) or empty pipe detection ·
 Wiring diagram no. 1 · Connector groups 8, 10, 12, 13, 18, 19, 20, 21, 120, 122, 124, 126, 128, 130, 132, 157, 159

	G2 flat seal	5...600	-10...70	16	< 0.35	18...32	14	SM2000
	G2 flat seal	5...300	-10...70	16	< 0.35	18...32	14	SM9000

Output function OUT1: analogue (4...20 mA) or IO-Link OUT2: Analogue (4...20 mA) · Wiring diagram no. 1 · Connector groups 8, 10, 18, 20, 120, 124, 126, 128, 157

	G2 flat seal	5...600	-10...70 / 14...158	16	< 0.35	18...32	14	SM2004
	G2 flat seal	5...300	-10...70 / 14...158	16	< 0.35	18...32	14	SM9004

Output function OUT1: normally open / normally closed programmable or pulse or frequency or empty pipe detection or IO-Link
 OUT2: normally open / normally closed programmable or analogue (4...20 mA; 0...10 V, scalable) or empty pipe detection ·
 Wiring diagram no. 1 · Connector groups 8, 10, 12, 13, 18, 19, 20, 21, 120, 122, 124, 126, 128, 130, 132, 157, 159

	G2 flat seal	5...900	-10...70	16	< 0.35	18...32	14	SM0510
---	--------------	---------	----------	----	--------	---------	----	--------



Magnetic-inductive flow meters with integrated temperature monitoring (sealing material EPDM) KTW / W270 approval

Type	Process connection	Measuring range [l/min]	Medium temperature [°C]	Pressure rating [bar]	Response time [s]	U _b [V]	Drawing no.	Order no.
------	--------------------	----------------------------	----------------------------	--------------------------	----------------------	-----------------------	-------------	-----------

Output function OUT1: normally open / normally closed programmable or pulse or frequency or empty pipe detection or IO-Link
 OUT2: normally open / normally closed programmable or analogue (4...20 mA; 0...10 V, scalable) or empty pipe detection ·
 Wiring diagram no. 1 · Connector groups 8, 10, 12, 13, 18, 19, 20, 21, 120, 122, 124, 126, 128, 130, 132, 157, 159

	G2 flat seal	5...600	-10...70	16	< 0.35	18...32	14	SM2100
---	--------------	---------	----------	----	--------	---------	----	--------

Output function OUT1: normally open / closed programmable or pulse OUT2: normally open / closed programmable or analogue (4...20 mA / 0...10 V, scaleable) · Wiring diagram no. 1 · Connector groups 8, 10, 18, 20, 120, 124, 126, 128, 157

	G½	0.10...25.00	-10...70	16	< 0.150	19...30	11	SM6100
	G¾	0.2...50.0	-10...70	16	< 0.150	19...30	12	SM7100

Process sensors

Type	Process connection	Measuring range [l/min]	Medium temperature [°C]	Pressure rating [bar]	Response time [s]	U _b [V]	Drawing no.	Order no.
------	--------------------	----------------------------	----------------------------	--------------------------	----------------------	-----------------------	-------------	-----------

Output function OUT1: normally open / closed programmable or pulse OUT2: normally open / closed programmable or analogue (4...20 mA / 0...10 V, scaleable) · Wiring diagram no. 1 · Connector groups 8, 10, 18, 20, 120, 124, 126, 128, 157

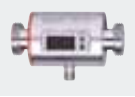

G1	0.2...100.0	-10...70	16	< 0.150	19...30	13	SM8100
----	-------------	----------	----	---------	---------	----	---------------

Output function OUT1: normally open / normally closed programmable or pulse or frequency or empty pipe detection or IO-Link OUT2: normally open / normally closed programmable or analogue (4...20 mA; 0...10 V, scalable) or empty pipe detection · Wiring diagram no. 1 · Connector groups 8, 10, 12, 13, 18, 19, 20, 21, 120, 122, 124, 126, 128, 130, 132, 157, 159



G2 flat seal	5...300	-10...70	16	< 0.35	18...32	14	SM9100
--------------	---------	----------	----	--------	---------	----	---------------

Magnetic-inductive flow meters (sealing material FKM)

Type	Process connection	Measuring range [l/min]	Medium temperature [°C]	Pressure rating [bar]	Response time [s]	U _b [V]	Drawing no.	Order no.
------	--------------------	----------------------------	----------------------------	--------------------------	----------------------	-----------------------	-------------	-----------

M12 connector · Output function 4...20 mA analogue · DC · Wiring diagram no. 4 · Connector groups 8, 10, 18, 20, 120, 124, 126, 128, 157

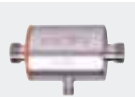

G $\frac{1}{2}$	0...25	-10...70	16	< 0.150	19...30	15	SM6050
-----------------	--------	----------	----	---------	---------	----	---------------



G $\frac{3}{4}$	0...50	-10...70	16	< 0.150	19...30	16	SM7050
-----------------	--------	----------	----	---------	---------	----	---------------



G1	0...100	-10...70	16	< 0.150	19...30	17	SM8050
----	---------	----------	----	---------	---------	----	---------------

Compact housings for adapters for flow monitoring

Type	Setting range liquids / gases [cm/s]	Material sensor tip	Medium temperature [°C]	Pressure rating [bar]	Response time [s]	U _b [V]	Drawing no.	Order no.
------	--	------------------------	----------------------------	--------------------------	----------------------	-----------------------	-------------	-----------

M12 connector · Wiring diagram no. 5 · Connector groups 8, 10, 18, 20, 120, 124, 126, 128, 157



3...300 / 200...3000	stainless steel 316L / 1.4404	-25...80	30	1...10	19...36	18	SI5000
----------------------	-------------------------------	----------	----	--------	---------	----	---------------

M12 connector · Wiring diagram no. 6 · Connector groups 8, 10, 18, 20, 120, 124, 126, 128, 157



3...300 / 200...3000	stainless steel 316L / 1.4404	-25...80	300	1...10	18...36	19	SI5002
----------------------	-------------------------------	----------	-----	--------	---------	----	---------------

Type	Setting range liquids / gases [cm/s]	Material sensor tip	Medium temperature [°C]	Pressure rating [bar]	Response time [s]	U _b [V]	Drawing no.	Order no.
------	---	---------------------	----------------------------	--------------------------	----------------------	-----------------------	-------------	-----------

1/2" UNF-Connector · Wiring diagram no. 7 · Connector group 30

	3...300 / 200...3000	stainless steel 316L / 1.4404	-25...80	300	1...10	85...265	20	SI5006*
---	----------------------	-------------------------------	----------	-----	--------	----------	----	---------

M12 connector · Wiring diagram no. 8 · Connector groups 8, 10, 18, 20, 120, 124, 126, 128, 157

	3...300 / -	stainless steel 316L / 1.4404	-25...80	300	1...10	19...36	19	SI5004
---	-------------	-------------------------------	----------	-----	--------	---------	----	--------

M12 connector · Wiring diagram no. 9 · Connector groups 8, 10, 18, 20, 120, 124, 126, 128, 157

	3...300 / 200...3000	stainless steel 316L / 1.4404	-25...80	300	1...2 / 1...10	18...36	19	SI5010
---	----------------------	-------------------------------	----------	-----	----------------	---------	----	--------



* Note for AC and AC/DC units

Miniature fuse to IEC60127-2 sheet 1, ≤ 5 A (fast acting) Recommendation: check the unit for reliable function after a short circuit.

Compact housings can be configured for T-pieces for flow monitoring

Type	Setting range liquids / gases [cm/s]	Material sensor tip	Medium temperature [°C]	Pressure rating [bar]	Response time [s]	U _b [V]	Drawing no.	Order no.
------	---	---------------------	----------------------------	--------------------------	----------------------	-----------------------	-------------	-----------

M12 connector · Wiring diagram no. 1 · Connector groups 8, 10, 12, 13, 18, 19, 20, 21, 120, 122, 124, 126, 128, 130, 132, 157, 159

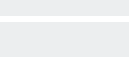
	5...300 / 200...10000	stainless steel (316L / 1.4404)	-20...100	50	0.5	18...30	21	SA4100
	5...300 / 200...10000	stainless steel (316L / 1.4404)	-20...100	50	0.5	18...30	21	SA4300
	5...300 / 200...10000	stainless steel (316L / 1.4404)	-20...90	100	0.5	18...30	22	SA5000

Compact housings for adapters for flow monitoring, Hastelloy sensor tip

Type	Setting range liquids / gases [cm/s]	Material sensor tip	Medium temperature [°C]	Pressure rating [bar]	Response time [s]	U _b [V]	Drawing no.	Order no.
------	---	---------------------	----------------------------	--------------------------	----------------------	-----------------------	-------------	-----------

M12 connector · Wiring diagram no. 9 · Connector groups 8, 10, 18, 20, 120, 124, 126, 128, 157

	3...300 / 200...3000	Hastelloy C-4 (2.4610)	-25...80	300	1...2 / 1...10	19...36	19	SI0553
---	----------------------	------------------------	----------	-----	----------------	---------	----	--------

Compact housings for adapters for flow monitoring, titanium sensor tip

Type	Setting range liquids / gases [cm/s]	Material sensor tip	Medium temperature [°C]	Pressure rating [bar]	Response time [s]	U _b [V]	Drawing no.	Order no.
------	---	---------------------	----------------------------	--------------------------	----------------------	-----------------------	-------------	-----------

M12 connector · Wiring diagram no. 9 · Connector groups 8, 10, 18, 20, 120, 124, 126, 128, 157

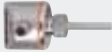
	3...300 / 200...3000	titanium (3.7035)	-25...80	300	1...2 / 1...10	19...36	19	SI5100
---	----------------------	-------------------	----------	-----	----------------	---------	----	--------

Compact designs for adapter with flow and temperature monitoring

Type	Setting range liquids / gases [cm/s]	Material sensor tip	Medium temperature [°C]	Pressure rating [bar]	Response time [s]	U _b [V]	Drawing no.	Order no.
------	---	---------------------	----------------------------	--------------------------	----------------------	-----------------------	-------------	-----------

M12 connector · Wiring diagram no. 6 · Connector groups 8, 10, 18, 20, 120, 124, 126, 128, 157

	3...300 / 200...3000	stainless steel 316L / 1.4404	-25...80	300	1...10	18...36	19	SI5007
---	----------------------	-------------------------------	----------	-----	--------	---------	----	--------

Compact housings for adapters with ATEX approval group II, category 3D / 3G

Type	Setting range liquids / gases [cm/s]	Material sensor tip	Medium temperature [°C]	Pressure rating [bar]	Response time [s]	U _b [V]	Drawing no.	Order no.
------	---	---------------------	----------------------------	--------------------------	----------------------	-----------------------	-------------	-----------

M12 connector · Wiring diagram no. 5 · Connector groups 154, 156

	3...300 / 200...3000	stainless steel 316L / 1.4404	-25...80	30	1...10	19...36	18	SI500A
---	----------------------	-------------------------------	----------	----	--------	---------	----	--------

Compact housings for adapters with Germanischer Lloyd (GL) approval

Type	Setting range liquids / gases [cm/s]	Material sensor tip	Medium temperature [°C]	Pressure rating [bar]	Response time [s]	U _b [V]	Drawing no.	Order no.
------	---	---------------------	----------------------------	--------------------------	----------------------	-----------------------	-------------	-----------



M12 connector · Wiring diagram no. 10 · Connector groups 8, 10, 18, 20, 120, 124, 126, 128, 157

	3...300	stainless steel 316L / 1.4404	-15...70	-	1...10	24	19	SI0521
---	---------	-------------------------------	----------	---	--------	----	----	--------

Compact housings for adapters for hygienic and wet areas

Type	Setting range liquids / gases [cm/s]	Material sensor tip	Medium temperature [°C]	Pressure rating [bar]	Response time [s]	U _b [V]	Draw- ing no.	Order no.
------	--	------------------------	-------------------------------	-----------------------------	-------------------------	-----------------------	---------------------	--------------

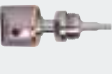
M12 connector · Wiring diagram no. 5 · Connector groups 8, 10, 18, 20, 120, 124, 126, 128, 157

	3...300 / 200...3000	stainless steel 316L / 1.4435	-25...95	30	1...10	19...36	23	SI6600
	3...300 / 200...3000	stainless steel 316L / 1.4435	-25...95	30	1...10	19...36	24	SI6700
	3...300 / 200...3000	stainless steel 316L / 1.4435	-25...95	30	1...10	19...36	25	SI6800

Mechatronic flow sensors for machine tools

Type	Process connection	Measuring range [l/min]	Medium temperature [°C]	Pressure rating [bar]	Response time [s]	U _b [V]	Draw- ing no.	Order no.
------	-----------------------	-------------------------------	-------------------------------	-----------------------------	-------------------------	-----------------------	---------------------	--------------

M12 connector · Output function  · DC PNP · Wiring diagram no. 11 · Connector groups 8, 10, 18, 20, 120, 124, 126, 128, 157

	G ½	0.3...25	0...60	200	< 0.01	24	26	SBU323
	G ½	0.3...50	0...60	200	< 0.01	24	26	SBU324

M12 connector · Output function analogue · DC · Wiring diagram no. 12 · Connector groups 8, 10, 18, 20, 120, 124, 126, 128, 157

	G ½	0.3...25	0...60	200	< 0.01	24	27	SBU623
	G ½	0.3...50	0...60	200	< 0.01	24	27	SBU624
	G ½	0.3...75	0...60	200	< 0.01	24	27	SBU625









Mechatronic flow sensors with display

Type	Process connection	Measuring range [l/min]	Medium temperature [°C]	Pressure rating [bar]	Response time [s]	U _b [V]	Draw- ing no.	Order no.
------	-----------------------	-------------------------------	-------------------------------	-----------------------------	-------------------------	-----------------------	---------------------	--------------





M12 connector · Output function OUT1: NO / NC programmable or frequency or IO-Link OUT2: NO / NC programmable or analogue · DC · Wiring diagram no. 1 · Connector groups 8, 10, 18, 20, 120, 124, 126, 128, 157



	Rp ¾	0.3...15	-10...100	40	0.01	18...30	28	SBY232
---	------	----------	-----------	----	------	---------	----	--------

Process sensors



Type	Process connection	Measuring range [l/min]	Medium temperature [°C]	Pressure rating [bar]	Response time [s]	U _b [V]	Drawing no.	Order no.
M12 connector · Output function OUT1: NO / NC programmable or frequency or IO-Link OUT2: NO / NC programmable or analogue · DC · Wiring diagram no. 1 · Connector groups 8, 10, 18, 20, 120, 124, 126, 128, 157								
	Rp 3/4	0.5...25	-10...100	40	0.01	18...30	28	SBY233
	Rp 3/4	1...50	-10...100	40	0.01	18...30	28	SBY234
	Rp 1	2...100	-10...100	25	0.01	18...30	29	SBY246
	Rp 1 1/2	4...200	-10...100	25	0.01	18...30	30	SBY257
	G 1/2	0.3...15	-10...100	40	0.01	18...30	31	SBG232
	G 1/2	0.5...25	-10...100	40	0.01	18...30	31	SBG233
	G 1/2	1...50	-10...100	40	0.01	18...30	31	SBG234
	G 3/4	2...100	-10...100	25	0.01	18...30	32	SBG246
	G 1 1/4	4...200	-10...100	25	0.01	18...30	33	SBG257

Mechatronic flow sensors for liquids

Type	Process connection	Measuring range [l/min]	Medium temperature [°C]	Pressure rating [bar]	Response time [s]	U _b [V]	Drawing no.	Order no.
M12 connector · Output function  · DC PNP · Wiring diagram no. 13 · Connector groups 8, 10, 18, 20, 120, 124, 126, 128, 157								
	Rp 3/4	1...15	0...85	40	< 0.01	24	34	SBY332
	Rp 1/2	2...20	0...85	80	< 0.01	24	35	SBY323
	Rp 3/4	1...25	0...85	40	< 0.01	24	34	SBY333
	Rp 3/4	2...50	0...85	40	< 0.01	24	34	SBY334

Type	Process connection	Measuring range [l/min]	Medium temperature [°C]	Pressure rating [bar]	Response time [s]	U _b [V]	Draw- ing no.	Order no.
M12 connector · Output function  · DC PNP · Wiring diagram no. 13 · Connector groups 8, 10, 18, 20, 120, 124, 126, 128, 157								
	Rp 1	5...100	0...85	25	< 0.01	24	36	SBY346
	Rp 1½	20...200	0...85	25	< 0.01	24	37	SBY357
	G ½	1...15	0...85	40	< 0.01	24	38	SBG332
	G ½	1...25	0...85	40	< 0.01	24	38	SBG333
	G ½	2...50	0...85	40	< 0.01	24	38	SBG334
	G ¾	5...100	0...85	25	< 0.01	24	39	SBG346
	G 1¼	20...200	0...85	25	< 0.01	24	40	SBG357

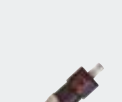
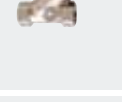
Mechatronic flow sensors for high temperatures

Type	Process connection	Measuring range [l/min]	Medium temperature [°C]	Pressure rating [bar]	Response time [s]	U _b [V]	Draw- ing no.	Order no.
M12 connector · Output function analogue · DC · Wiring diagram no. 12 · Connector groups 8, 10, 18, 20, 120, 124, 126, 128, 157								
	Rp ¾	1...25	-10...100	40	< 0.01	18...32	41	SBY433
	Rp ¾	2...50	-10...100	40	< 0.01	18...32	41	SBY434
	Rp 1	4...100	-10...100	25	< 0.01	18...32	42	SBY446
	Rp 1½	8...200	-10...100	25	< 0.01	18...32	43	SBY457
Cable with connector 0.3 m · Output function analogue · DC · Wiring diagram no. 12 · Connector groups 8, 10, 18, 20, 120, 124, 126, 128, 157								
	Rp ¾	0.3...25	10...180	15	< 0.01	24	44	SBT633
	Rp ¾	0.3...50	10...180	15	< 0.01	24	44	SBT634

Process sensors

Type	Process connection	Measuring range [l/min]	Medium temperature [°C]	Pressure rating [bar]	Response time [s]	U _b [V]	Draw- ing no.	Order no.
------	--------------------	----------------------------	----------------------------	--------------------------	----------------------	-----------------------	---------------------	--------------

Cable with connector 0.3 m · Output function analogue · DC · Wiring diagram no. 12 · Connector groups 8, 10, 18, 20, 120, 124, 126, 128, 157



G 3/4	0.3...25	10...180	15	< 0.01	24	45	SBM613
-------	----------	----------	----	--------	----	----	---------------

Flow sensors for connection to control monitors, industrial applications

Type	Setting range liquids / gases [cm/s]	Greatest sensitivity [cm/s]	Medium temperature [°C]	Response time [s]	Max. T ₀ gradient [K/min]	Pressure rating [bar]	Draw- ing no.	Order no.
------	--	-----------------------------------	-------------------------------	-------------------------	--	-----------------------------	---------------------	--------------

M12 connector · Wiring diagram no. 14 · Connector groups 12, 13, 19, 21, 122, 126, 128, 132, 159

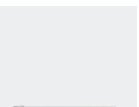

3...300 / 200...3000	3...60 / 200...800	-25...80	1...10	30	30	46	SF6200
----------------------	--------------------	----------	--------	----	----	----	---------------

3...300 / 200...3000	3...60 / 200...800	-25...80	1...10	30	30	47	SF6201
----------------------	--------------------	----------	--------	----	----	----	---------------

M12 connector · Wiring diagram no. 14 · Connector groups 122, 126, 128, 132, 159

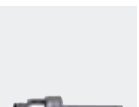

3...300 / 200...3000	3...60 / 200...800	-25...80	1...10	300	300	48	SF5200
----------------------	--------------------	----------	--------	-----	-----	----	---------------

3...300 / 200...3000	3...60 / 200...800	-25...80	1...10	300	30	49	SF5201
----------------------	--------------------	----------	--------	-----	----	----	---------------

Cable 6 m · Wiring diagram no. 15



3...300 / 200...3000	3...60 / 200...800	-25...80	1...10	300	300	50	SF5350
----------------------	--------------------	----------	--------	-----	-----	----	---------------

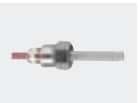

3...300 / 200...3000	3...60 / 200...800	0...120 / 0...100	1...10	300	300	50	SF5300
----------------------	--------------------	-------------------	--------	-----	-----	----	---------------

Flow sensors for connection to control monitors, industrial applications, titanium housing

Type	Setting range liquids / gases [cm/s]	Greatest sensitivity [cm/s]	Medium temperature [°C]	Response time [s]	Max. T ₀ gradient [K/min]	Pressure rating [bar]	Draw- ing no.	Order no.
------	--	-----------------------------------	-------------------------------	-------------------------	--	-----------------------------	---------------------	--------------

Cable 6 m · Wiring diagram no. 15

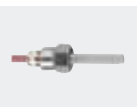

3...300 / 200...3000	3...60 / 200...800	0...120 / 0...100	1...10	300	100	50	SF5800
----------------------	--------------------	-------------------	--------	-----	-----	----	---------------

M12 connector · Wiring diagram no. 14 · Connector groups 122, 126, 128, 132, 159



3...300 / 200...3000	3...60 / 200...800	-25...80	1...10	300	100	48	SF5700
----------------------	--------------------	----------	--------	-----	-----	----	---------------

Product selectors and further information can be found at: www.ifm.com

Type	Setting range liquids / gases [cm/s]	Greatest sensitivity [cm/s]	Medium temperature [°C]	Response time [s]	Max. T ₀ gradient [K/min]	Pressure rating [bar]	Drawing no.	Order no.
------	---	--------------------------------	----------------------------	----------------------	---	--------------------------	-------------	-----------

M12 connector · Wiring diagram no. 14 · Connector groups 122, 126, 128, 132, 159

	3...300 / 200...3000	3...60 / 200...800	-25...80	1...10	300	100	51	SF5701
	3...300 / 200...3000	3...60 / 200...800	-25...80	1...10	300	100	52	SF5702
	3...300 / 200...3000	3...60 / 200...800	-25...80	1...10	300	100	53	SF5703
	3...300 / 200...3000	3...60 / 200...800	-25...80	1...10	300	100	54	SF5704

Flow sensors for connection to control monitors for hygienic and wet areas

Type	Setting range liquids / gases [cm/s]	Greatest sensitivity [cm/s]	Medium temperature [°C]	Response time [s]	Max. T ₀ gradient [K/min]	Pressure rating [bar]	Drawing no.	Order no.
------	---	--------------------------------	----------------------------	----------------------	---	--------------------------	-------------	-----------



Cable 6 m · Wiring diagram no. 15

	3...300 / 200...2000	3...60 / 200...800	0...120 / 0...100	1...10	15	30	-	SF0516
---	----------------------	--------------------	-------------------	--------	----	----	---	--------



Flow sensors for connection to control monitors for aggressive media, ceramic housing

Type	Setting range liquids / gases [cm/s]	Greatest sensitivity [cm/s]	Medium temperature [°C]	Response time [s]	Max. T ₀ gradient [K/min]	Pressure rating [bar]	Drawing no.	Order no.
------	---	--------------------------------	----------------------------	----------------------	---	--------------------------	-------------	-----------

M12 connector · Wiring diagram no. 14 · Connector groups 12, 13, 19, 21, 122, 126, 128, 132, 159

	3...60 / -	3...40 / -	5...70	2...20	7	30	55	SF2405
	3...60 / -	3...40 / -	5...70	2...20	7	30	56	SF3405

Cable 6 m · Wiring diagram no. 15

	3...60 / -	3...40 / -	5...70	2...20	7	30	57	SF2410
	3...60 / -	3...40 / -	5...70	2...20	7	30	58	SF3410

Process sensors

Type	Setting range liquids / gases [cm/s]	Greatest sensitivity [cm/s]	Medium temperature [°C]	Response time [s]	Max. T ₀ gradient [K/min]	Pressure rating [bar]	Draw- ing no.	Order no.
------	---	--------------------------------	----------------------------	----------------------	---	--------------------------	---------------------	--------------





Cable 16 m · Wiring diagram no. 15

	3...60	3...40	5...70	2...20	7	30	57	SF0540
---	--------	--------	--------	--------	---	----	----	--------



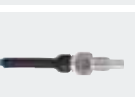
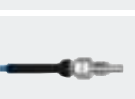

Flow sensors for connection to control monitors with ATEX approval

Type	Setting range liquids / gases [cm/s]	Greatest sensitivity [cm/s]	Medium temperature [°C]	Response time [s]	Max. T ₀ gradient [K/min]	Pressure rating [bar]	Draw- ing no.	Order no.
------	---	--------------------------------	----------------------------	----------------------	---	--------------------------	---------------------	--------------

Cable 6 m · Wiring diagram no. 16

	3...300 / 200...2000	3...60 / 200...800	-20...60	1...10	15	300	59	SF111A
	3...300 / 200...2000	3...60 / 200...800	-20...60	1...10	15	300	60	SF211A
	3...300 / 200...2000	3...60 / 200...800	-20...60	1...10	15	300	61	SF311A
	3...300 / 200...2000	3...60 / 200...800	-20...70	1...10	15	30	62	SF121A
	3...300 / 200...2000	3...60 / 200...800	-20...70	1...10	15	30	63	SF221A
	3...300 / 200...2000	3...60 / 200...800	-20...70	1...10	15	30	64	SF321A



M12 connector · Wiring diagram no. 17 · Connector group 155

	3...300 / 200...2000	3...60 / 200...800	-20...70	1...10	15	30	65	SF120A
	3...300 / 200...2000	3...60 / 200...800	-20...70	1...10	15	30	66	SF220A
	3...300 / 200...2000	3...60 / 200...800	-20...70	1...10	15	30	67	SF320A
	3...300 / 200...3000	3...60 / 200...800	-20...70	1...10	15	30	46	SF620A

Flow sensors for connection to control monitors with ATEX approval, ceramic housing

Type	Setting range liquids / gases [cm/s]	Greatest sensitivity [cm/s]	Medium temperature [°C]	Response time [s]	Max. T ₀ gradient [K/min]	Pressure rating [bar]	Drawing no.	Order no.
------	---	--------------------------------	----------------------------	----------------------	---	--------------------------	-------------	-----------

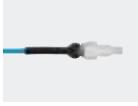
Cable 6 m · Wiring diagram no. 16

	3...60 / -	3...40 / -	5...70	2...20	7	30	57	SF223A
	3...60 / -	3...40 / -	5...70	2...20	7	30	58	SF323A

Flow sensors for connection to control monitors with ATEX approval 2G

Type	Setting range liquids / gases [cm/s]	Greatest sensitivity [cm/s]	Medium temperature [°C]	Response time [s]	Max. T ₀ gradient [K/min]	Pressure rating [bar]	Drawing no.	Order no.
------	---	--------------------------------	----------------------------	----------------------	---	--------------------------	-------------	-----------

Cable 6 m · Wiring diagram no. 18

	3...300 / 100...15000	3...100 / 100...7500	-20...70	1...10	30	30	68	SP321A
--	-----------------------	----------------------	----------	--------	----	----	----	--------

Air flow monitors

Type	Setting range liquids / gases [cm/s]	Greatest sensitivity [cm/s]	Medium temperature [°C]	Response time [s]	U _b / tolerance [V] / [%]	Drawing no.	Order no.
------	---	--------------------------------	----------------------------	----------------------	---	-------------	-----------

Cable 2 m · Wiring diagram no. 19

	100...1000	100...400	-10...50	3...60	80...250 AC	69	SL0101*
---	------------	-----------	----------	--------	-------------	----	---------

Cable 2 m · Wiring diagram no. 20

	100...1000	100...400	-10...50	3...60	24 AC	69	SL0201*
---	------------	-----------	----------	--------	-------	----	---------

Cable 2 m · Wiring diagram no. 21

	100...1000	100...400	-10...50	3...60	24 DC ± 25 %	69	SL5101
---	------------	-----------	----------	--------	--------------	----	--------





*** Note for AC and AC/DC units**

Miniature fuse to IEC60127-2 sheet 1, ≤ 5 A (fast acting) Recommendation: check the unit for reliable function after a short circuit.

Compressed air meters

Type	Process connection	Setting range [Nm ³ /h]	Pressure rating [bar]	Response time [s]	U _b [V]	Drawing no.	Order no.
------	--------------------	---------------------------------------	--------------------------	----------------------	-----------------------	-------------	-----------

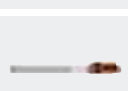
Output function OUT1: normally open / closed programmable or pulse OUT2: normally open / closed programmable or analogue (4...20 mA scaleable) · Wiring diagram no. 22 · Connector groups 8, 10, 18, 20, 120, 124, 126, 128, 157

	G ¼ (DN8)	0.12...15.00	16	< 0.1	18...30	70	SD5000
	R½ (DN15)	0.6...75.0	16	< 0.1	18...30	71	SD6000
	G ½ (DN15)	0.6...75	16	< 0.1	18...30	72	SD6050
	R1 (DN25)	1.8...225.0	16	< 0.1	18...30	73	SD8000
	R1½ (DN40)	3.5...410.0	16	< 0.1	18...30	74	SD9000
	R2 (DN50)	5...700	16	< 0.1	18...30	75	SD2000



Output function OUT1: normally open / closed programmable or pulse OUT2: normally open / closed programmable or analogue (4...20 mA scaleable) · Wiring diagram no. 1 · Connector groups 8, 10, 18, 20, 120, 124, 126, 128, 157

	G 1 1	18...2110	16	< 0.1	18...30	76	SD0523
---	-------	-----------	----	-------	---------	----	--------

Compressed air meter for special gases

Type	Process connection	Setting range [Nm ³ /h]	Medium temperature [°C]	Pressure rating [bar]	Response time [s]	U _b [V]	Drawing no.	Order no.
------	--------------------	---------------------------------------	----------------------------	--------------------------	----------------------	-----------------------	-------------	-----------



Output function OUT1: normally open / closed programmable or pulse OUT2: normally open / closed programmable or analogue (4...20 mA scaleable) · Wiring diagram no. 25 · Connector groups 8, 10, 18, 20, 120, 124, 126, 128, 157

	G ¼ (DN8)	N ₂ : 0.04...15.00 / Ar: 0.08...24.04 / CO ₂ : 0.04...14.36	0...60	16	< 0.1	18...30	70	SD5100
	R½ (DN15)	Ar: 0.39 (0.4)...118.2 / CO ₂ : 0.24 (0.2)...71.7 / N ₂ : 0.24 (0.2)...73.0	0...60	16	< 0.1	18...30	77	SD6100



Ultrasonic flow meters for liquids (water, glycol solutions, oils)

Type	Process connection	Measuring range [l/min]	Medium temperature [°C]	Pressure rating [bar]	Response time [s]	U _b [V]	Drawing no.	Order no.
------	--------------------	----------------------------	----------------------------	--------------------------	----------------------	-----------------------	-------------	-----------

Output function 2 x normally open / closed programmable · Wiring diagram no. 6 · Connector groups 8, 10, 18, 20, 120, 124, 126, 128, 157

	G $\frac{3}{4}$	0.1...50.0	-10...80	16	< 0.250	19...30	78	SU7200
	G1	0.2...100.0	-10...80	16	< 0.250	19...30	79	SU8200





Output function OUT1: normally open / closed programmable or pulse OUT2: normally open / closed programmable or analogue (4...20 mA / 0...10 V, scaleable) · Wiring diagram no. 23 · Connector groups 8, 10, 18, 20, 120, 124, 126, 128, 157











	G $\frac{3}{4}$	0.1...50.0	-10...80	16	< 0.250	19...30	78	SU7000
	G1	0.2...100.0	-10...80	16	< 0.250	19...30	79	SU8000
	G1 $\frac{1}{4}$	0.4...200.0	-10...80	16	< 0.250	19...30	80	SU9000

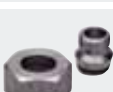

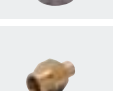
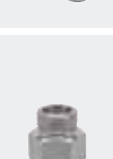
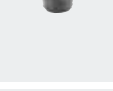
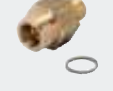
Output function 2 x analogue (4...20 mA scaleable) · Wiring diagram no. 24 · Connector groups 8, 10, 18, 20, 120, 124, 126, 128, 157

	G1 $\frac{1}{4}$	0.0...200.0	-10...80	16	< 0.250	19...30	80	SU9004
---	------------------	-------------	----------	----	---------	---------	----	--------

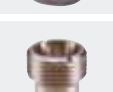
Accessories for flow sensors and control monitors









Type	Description	Order no.
	T-piece · R $\frac{1}{2}$ · M26 x 1.5 · R $\frac{1}{2}$ · for sensors and adapters with process connection M26 x 1.5 · Flow rate: 0...10 l/min · Housing materials: stainless steel 316L / 1.4404	E40136
	Progressive ring T-piece DIN 2353 · QL 18-18-18 · for sensors and adapters with process connection M26 x 1.5 · Recommendation: precision steel pipes 18 x 1.5 to DIN 2391/ISO 3304 · Housing materials: stainless steel 316Ti / 1.4571	E40078
	Progressive ring T-piece DIN 2353 · QL 22-18-22 · for sensors and adapters with process connection M26 x 1.5 · Recommendation: precision steel pipes 22 x 1.5 to DIN 2391/ISO 3304 · Housing materials: stainless steel 316Ti / 1.4571	E40079
	Progressive ring T-piece DIN 2353 · QL 28-18-28 · for sensors and adapters with process connection M26 x 1.5 · Recommendation: precision steel pipes 28 x 1.5 to DIN 2391/ISO 3304 · Housing materials: brass	E40083
	Adapter block · D10 / G $\frac{1}{4}$ · for flow sensors type SID, SF5 · Optimised for the following volumetric flow quantities (factory setting with water): · 0.2...2 l/min (SI1xxx) 0.2...3 l/min (SI5xxx) · Housing materials: stainless steel 316L / 1.4404	E40161

Type	Description	Order no.
	Adapter block · D16 / G ½ · for flow sensors type SID, SF5 · Optimised for the following volumetric flow quantities (factory setting with water): · 0.5...5 l/min (SI1xxx) 0.5...7 l/min (SI5xxx) · Housing materials: stainless steel 316L / 1.4404	E40162
	Adapter · M18 x 1.5 - G ½ · Insertion depth of the probe of SID, SFD, TN: · 21 mm · Housing materials: titanium	E40114
	Adapter · M18 x 1.5 - G ¼ · Insertion depth of the probe of SID, SFD, TN: · 13.5 mm · Housing materials: titanium	E40115
	Adapter · M18 x 1.5 - L18 · for mounting in T-pieces · Insertion depth of the probe of SID, SFD, TN: · 28.5 mm · Housing materials: nut: stainless steel 316Ti / 1.4571 / adapter: stainless steel 316L / 1.4404 / O-ring: FKM 16 x 1.5 gr 70° Shore A	E40104
	Adapter · M18 x 1.5 - M12 x 1 · Insertion depth of the probe of SID, SFD, TN: · 13.5 mm · Housing materials: stainless steel 316L / 1.4404	E40101
	Adapter · M18 x 1.5 - M12 x 1 · Insertion depth of the probe of SID, SFD, TN: · 13.5 mm · Housing materials: brass	E40100
	Adapter · M18 x 1.5 - ¼" NPT · Insertion depth of the probe of SID, SFD, TN: · 13.9 mm · Housing materials: stainless steel 316L / 1.4404	E40106
	Adapter · M18 x 1.5 - G ¼ · Insertion depth of the probe of SID, SFD, TN: · 13.5 mm · Housing materials: stainless steel 316L / 1.4404	E40099
	Adapter · M18 x 1.5 - G ¼ · Insertion depth of the probe of SID, SFD, TN: · 13.5 mm · Housing materials: brass	E40098
	Adapter · M18 x 1.5 - G ½ · Insertion depth of the probe of SID, SFD, TN: · 21 mm · Housing materials: stainless steel 316L / 1.4404	E40096
	Adapter · M18 x 1.5 - G ½ · Insertion depth of the probe of SID, SFD, TN: · 21 mm · Housing materials: brass	E40097
	Mounting adapter · M18 x 1.5 - Ø 23 mm · Insertion depth of the probe of SID, SFD, TN: · 21 mm · Housing materials: PE-100	E40138
	Welding adapter · M18 x 1.5 - Ø 24 mm · Insertion depth of the probe of SID, SFD, TN: · 15 mm · Housing materials: stainless steel 316L / 1.4404	E40124
	Welding adapter · Welding adapter · for compressed air meter type SD · Housing materials: stainless steel 316L / 1.4404	E40195
	Flow adapter (for low flow rates) · M12 x 1 - G 1/8 · for flow sensors and compact flow monitors with adapter · Housing materials: stainless steel 316L / 1.4404	E40129

Type	Description	Order no.
	Combicon connector · with cage clamps 4 poles · Housing materials: current carrying parts: copper alloy tin-plated	E40171
	Protective cover · for flow sensors type SI5xxx, SI6xxx, SR59xx · Housing materials: PP uncoloured	E40203

Flange adapters for flow sensors

Type	Description	Order no.
	Mounting plate · Housing materials: stainless steel 316L / 1.4404	E40249
	Clamp adapter · Clamp · 1-1.5" · ISO 2852 · for units with Aseptoflex Vario adapter · Sealing by sealing ring · Housing materials: stainless steel 316L / 1.4435	E33201
	Clamp adapter · Clamp · 2" · ISO 2852 · for units with Aseptoflex Vario adapter · Sealing by sealing ring · Housing materials: stainless steel 316L / 1.4435	E33202
	Clamp adapter · Clamp · 1-1.5" · ISO 2852 · for units with Aseptoflex Vario adapter · Metal to metal seal · Housing materials: stainless steel 316L / 1.4435	E33701
	Clamp adapter · Clamp · 2" · ISO 2852 · for units with Aseptoflex Vario adapter · Metal to metal seal · Housing materials: stainless steel 316L / 1.4435	E33702
	Pipe fitting · Hygienic pipe fitting · Hygienic pipe fitting · DN32 (1.25") · DIN 11851 · for units with Aseptoflex Vario adapter · Sealing by sealing ring · Housing materials: stainless steel 316L / 1.4435	E33211
	Pipe fitting · Hygienic pipe fitting · Hygienic pipe fitting · DN40 (1.5") · DIN 11851 · for units with Aseptoflex Vario adapter · Sealing by sealing ring · Housing materials: stainless steel 316L / 1.4435	E33212
	Pipe fitting · Hygienic pipe fitting · Hygienic pipe fitting · DN50 (2") · DIN 11851 · for units with Aseptoflex Vario adapter · Sealing by sealing ring · Housing materials: stainless steel 316L / 1.4435	E33213
	Pipe fitting · Hygienic pipe fitting · Hygienic pipe fitting · DN32 (1.25") · DIN 11851 · for units with Aseptoflex Vario adapter · Metal to metal seal · Housing materials: stainless steel 316L / 1.4435	E33711
	Pipe fitting · Hygienic pipe fitting · Hygienic pipe fitting · DN40 (1.5") · DIN 11851 · for units with Aseptoflex Vario adapter · Metal to metal seal · Housing materials: stainless steel 316L / 1.4435	E33712
	Pipe fitting · Hygienic pipe fitting · Hygienic pipe fitting · DN50 (2") · DIN 11851 · for units with Aseptoflex Vario adapter · Metal to metal seal · Housing materials: stainless steel 316L / 1.4435	E33713













Type	Description	Order no.
	Clamp adapter · Varivent Adapter · Varivent type F · DN25 (1"), D = 50 · for units with Aseptoflex Vario adapter · Sealing by sealing ring · Housing materials: stainless steel 316L / 1.4435	E33221
	Clamp adapter · Varivent Adapter · Varivent type N · DN40...DN150 (1.5...6"), D = 68 · for units with Aseptoflex Vario adapter · Sealing by sealing ring · Housing materials: stainless steel 316L / 1.4435	E33222
	Clamp adapter · Varivent Adapter · Varivent type F · DN25 (1"), D = 50 · for units with Aseptoflex Vario adapter · Metal to metal seal · Housing materials: stainless steel 316L / 1.4435	E33721
	Clamp adapter · Varivent Adapter · Varivent type N · DN40...DN150 (1.5...6"), D = 68 · for units with Aseptoflex Vario adapter · Metal to metal seal · Housing materials: stainless steel 316L / 1.4435	E33722
	Pipe fitting · SMS pipe fitting · DN40 (1.5") · SMS · for units with Aseptoflex Vario adapter · Metal to metal seal · Housing materials: stainless steel 316L / 1.4435	E33731
	Pipe fitting · SMS pipe fitting · DN50 (2") · SMS · for units with Aseptoflex Vario adapter · Metal to metal seal · Housing materials: stainless steel 316L / 1.4435	E33732
	Flange adapter · DRD adapter · flange · DRD · D = 65 · for units with Aseptoflex Vario adapter · Sealing by sealing ring · Housing materials: stainless steel 316L / 1.4435	E33242
	Welding adapter · Ø 50 mm · for units with Aseptoflex Vario adapter · Sealing by sealing ring · Housing materials: stainless steel 316L / 1.4435	E30122

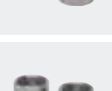
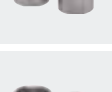

Accessories for airflow monitors

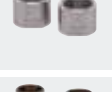
Type	Description	Order no.
	Mounting clamp · Ø 23 mm · for air flow monitor SLG · Housing materials: PBT	E40048

Accessories for flow meters

Type	Description	Order no.
	Adapter · G ½ - R ½ · for flow monitor type SM6 · flat seal · Housing materials: stainless steel 316Ti / 1.4571	E40199
	Adapter · G ½ - G ¾ · for flow monitor type SM6 · flat seal · Housing materials: stainless steel 316L / 1.4404	E40189
	Adapter · G ¾ - R ½ · for flow monitor type SM7 / SU7 · Housing materials: stainless steel 316L / 1.4404	E40178

Type	Description	Order no.
	Adapter · G 1 - R 1/2 · for flow monitor type SM8 / SU8 · Housing materials: stainless steel 316L / 1.4404	E40179
	Adapter · G 1 - R 3/4 · for flow monitor type SM8 / SU8 · Housing materials: stainless steel 316L / 1.4404	E40180
	Adapter · G 3/4 I - R 1/2 · for flow monitor type SM7 / SU7 · Housing materials: Brass	E40151
	Adapter · G 1 - R 3/4 · for flow monitor type SM8 / SU8 · Housing materials: Brass	E40153
	Adapter · G 1 1/4 - R 1 · for flow monitor type SU9 · Housing materials: stainless steel 316L / 1.4404	E40205
	Adapter · G 1/2 - G 1/2 · for flow monitor type SM6 · Housing materials: stainless steel 316L / 1.4404	E40213
	Adapter · G 3/4 - G 1/2 · for flow monitor type SM7 / SU7 · Housing materials: stainless steel 316L / 1.4404	E40214
	Adapter · G 1 - G 3/4 · for flow monitor type SM8 / SU8 · Housing materials: stainless steel 316L / 1.4404	E40215
	Adapter · G 3/4 - G 3/4 · for flow monitor type SM7 / SU7 · Housing materials: stainless steel 316L / 1.4404	E40216
	Adapter · G 1 - G 1 · for flow monitor type SM8 / SU8 · Housing materials: stainless steel 316L / 1.4404	E40217
	Adapter · Victaulic · for flow sensors type SM2, SM9 · Housing materials: stainless steel 316Ti / 1.4571	E40227
	Adapter · 2" NPT · for flow sensors type SM2, SM9 · Housing materials: stainless steel 316Ti / 1.4571	E40228
	Adapter · 1 1/2" NPT · for flow sensors type SM2, SM9 · Housing materials: stainless steel 316Ti / 1.4571	E40229
	Adapter · G 1 1/2 · for flow sensors type SM2, SM9 · Housing materials: stainless steel 316Ti / 1.4571	E40230
	Adapter · R 2" A · for flow sensors type SM2, SM9 · Housing materials: stainless steel 316Ti / 1.4571	E40231

Type	Description	Order no.
	Flange adapter · Flange adapter · Adapter · rotatable · for type SM2, SM9 · Housing materials: flange: stainless steel / adapter: stainless steel 316Ti / 1.4571 / O-ring: EPDM	E40240
	Regulating valve · G 1/2 · G 1/2 · Housing materials: Brass nickel-plated / EPDM	E40250
	Regulating valve · G 3/4 · G 3/4 · Housing materials: Brass nickel-plated / EPDM	E40251

Grounding clamps for magnetic-inductive flow meters

Type	Description	Order no.
	Grounding clamp · Housing materials: stainless steel 316L / 1.4404	E40234

Wiring diagrams

Core colours

- BK black
- BN brown
- BU blue
- WH white
- GY grey

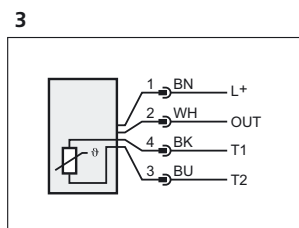
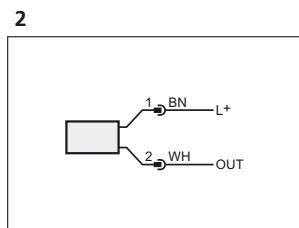
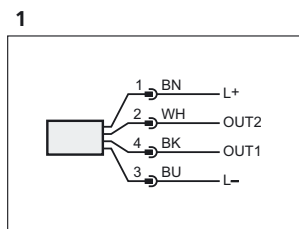

OUT: Analogue output,
T1 / T2: Pt1000: -

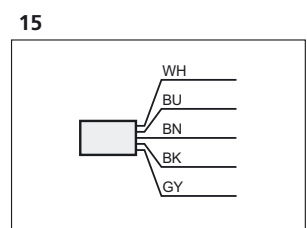
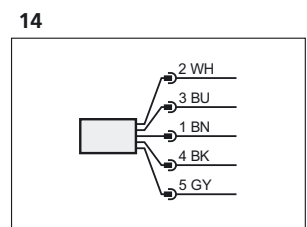
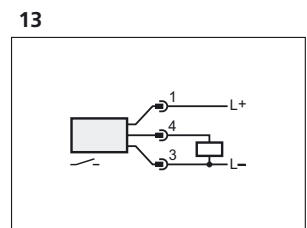
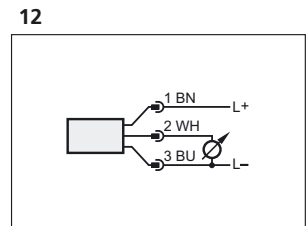
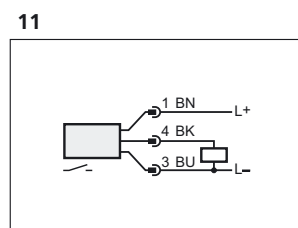
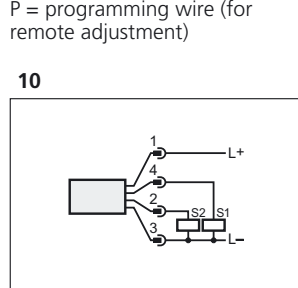
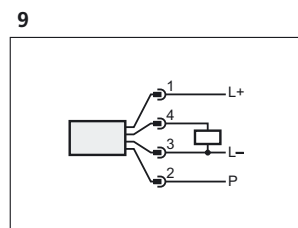
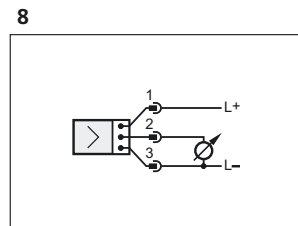
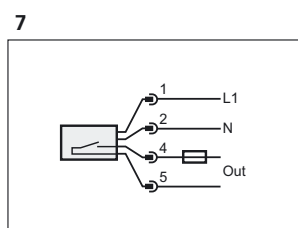
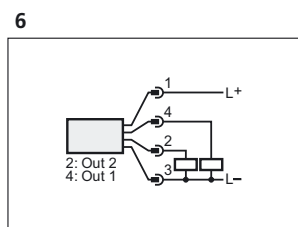
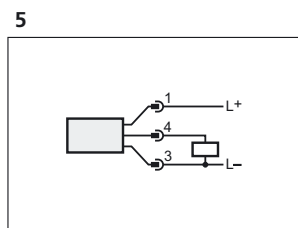
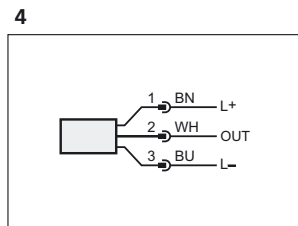

P = programming wire (for remote adjustment)

Wiring diagrams

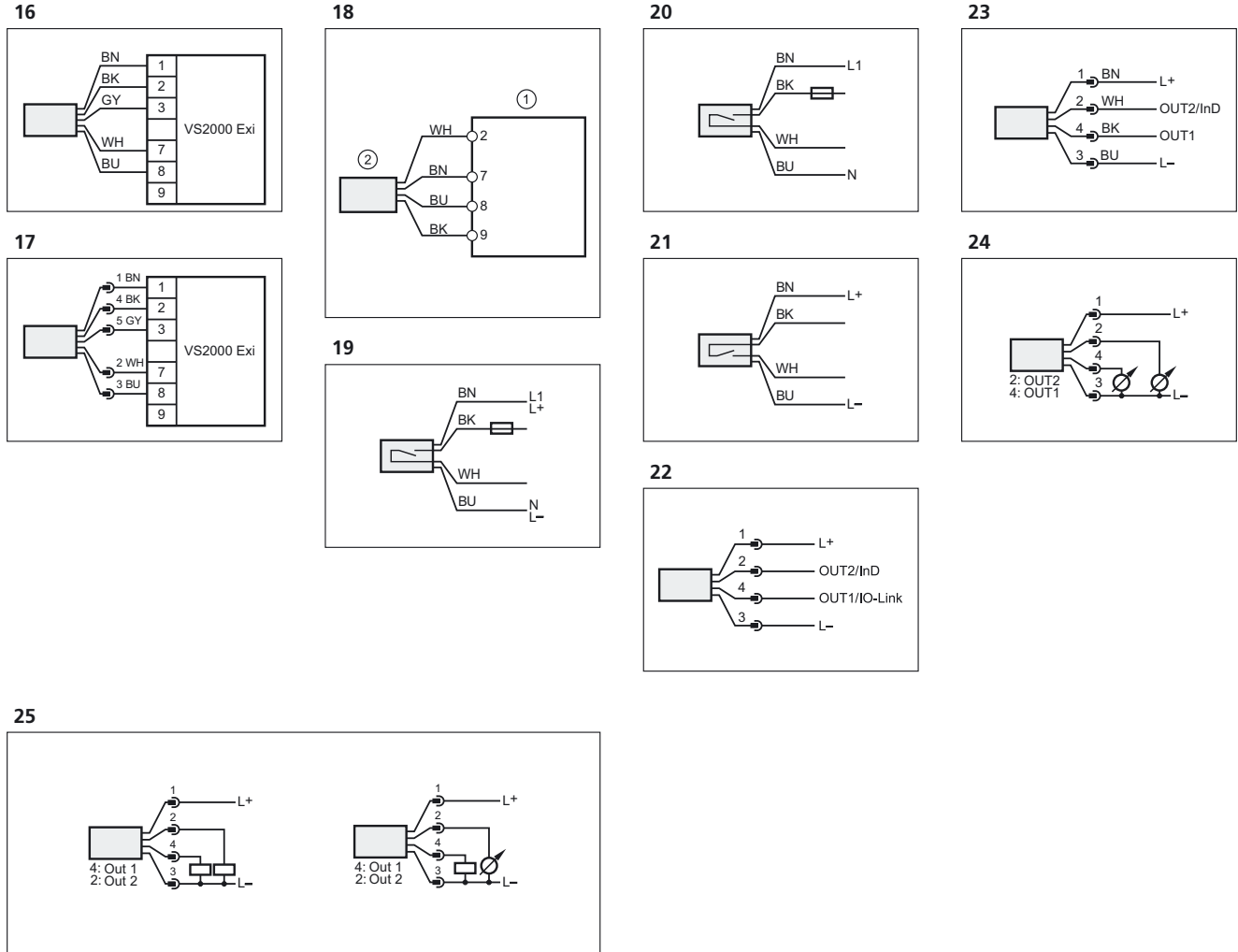

Scale drawings / drawing no. – CAD download: www.ifm.com

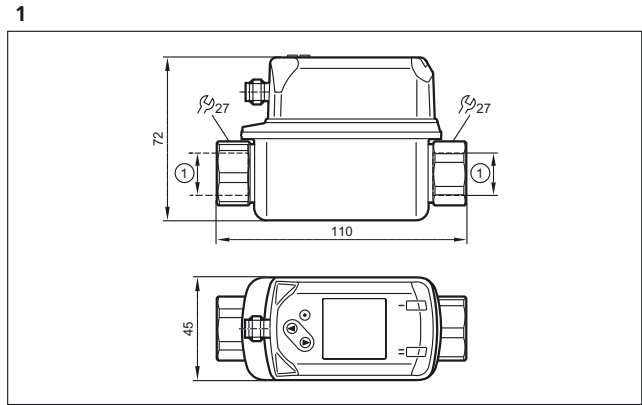

1: Process connection, see data sheet

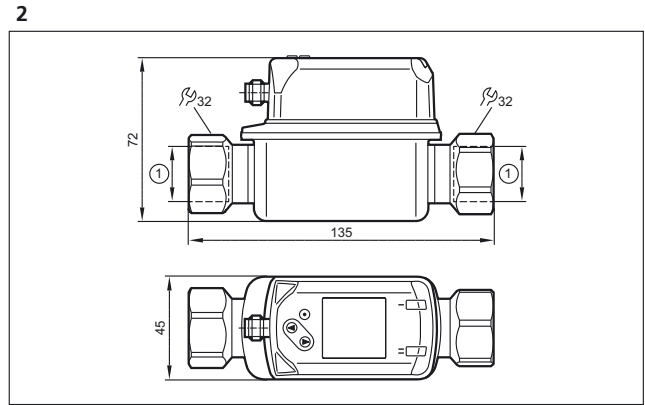

1: Process connection, see data sheet

Scale drawings / drawing no. – CAD download: www.ifm.com

3

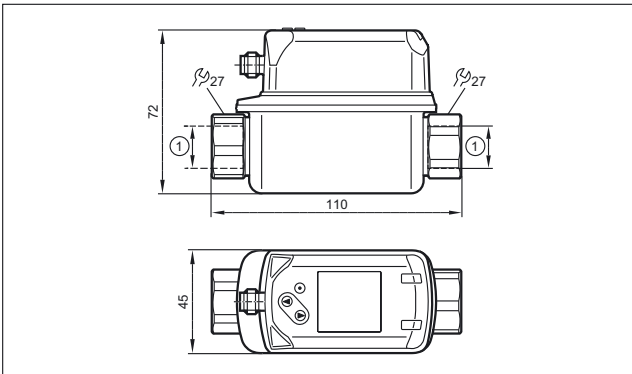

7

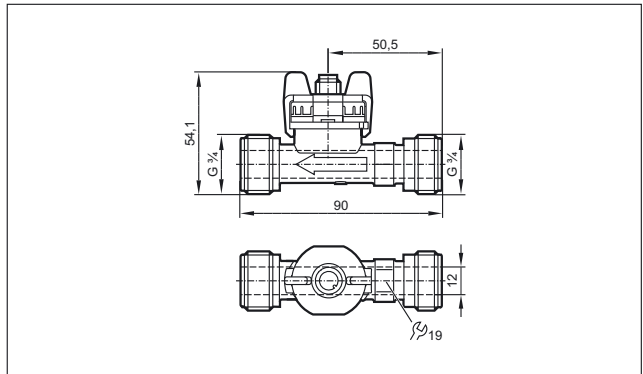

4

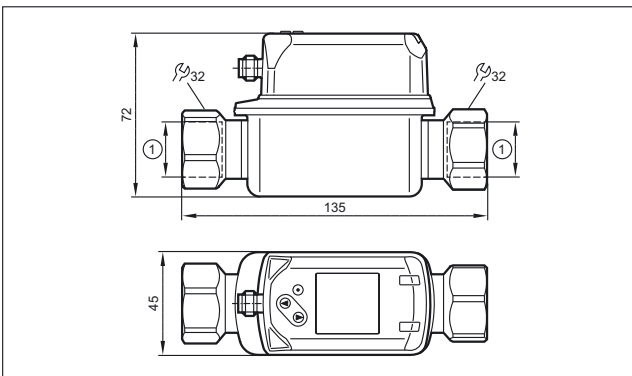

8

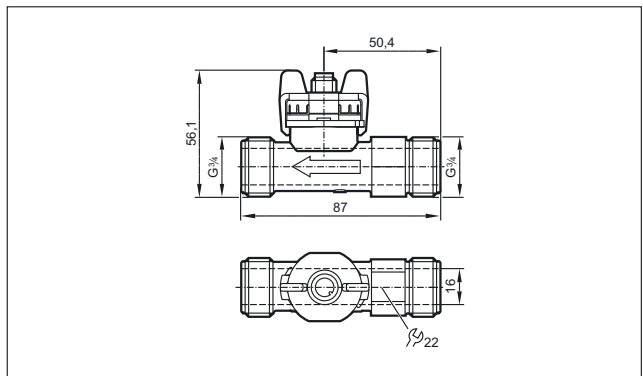

5

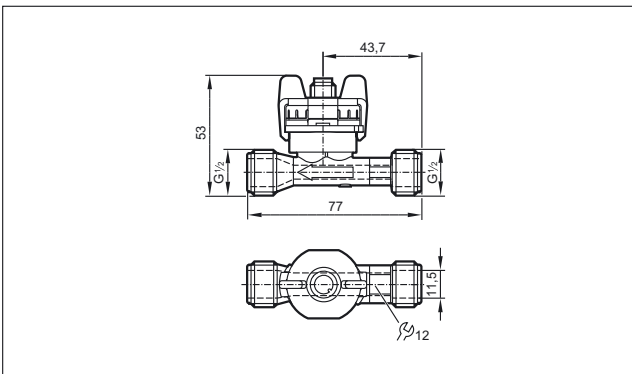

9

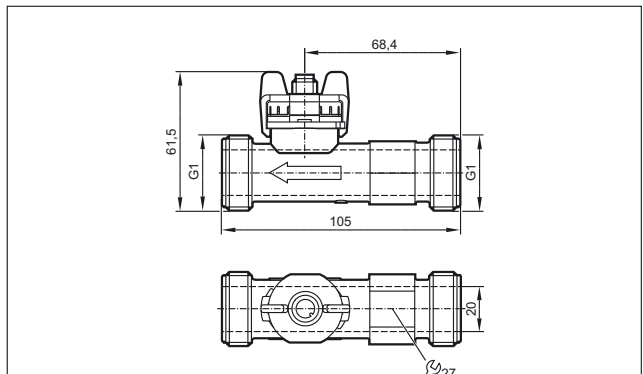

6

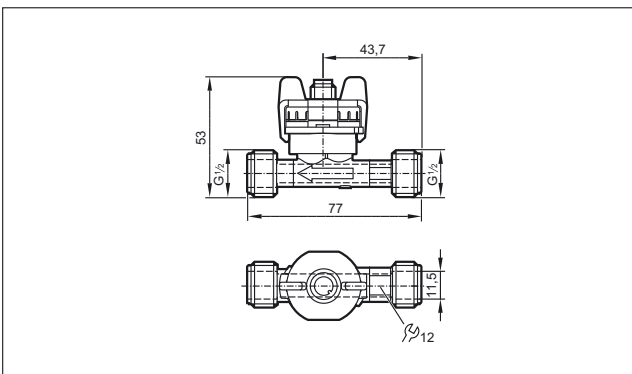

10

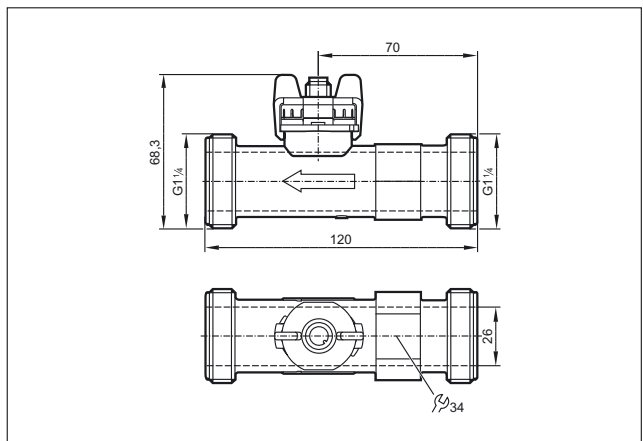

Scale drawings / drawing no. – CAD download: www.ifm.com

11

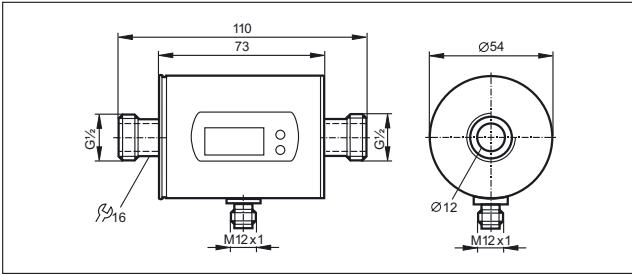

12

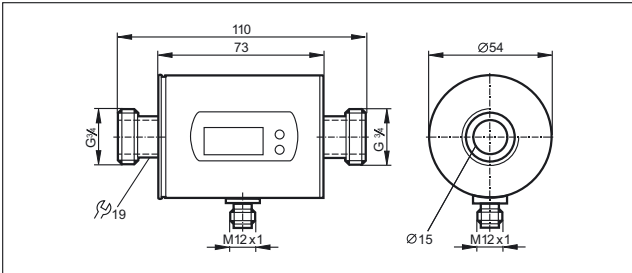

13

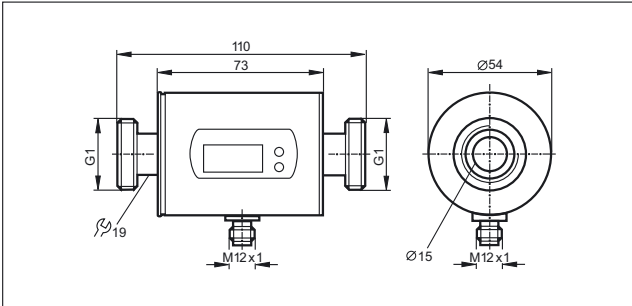

14

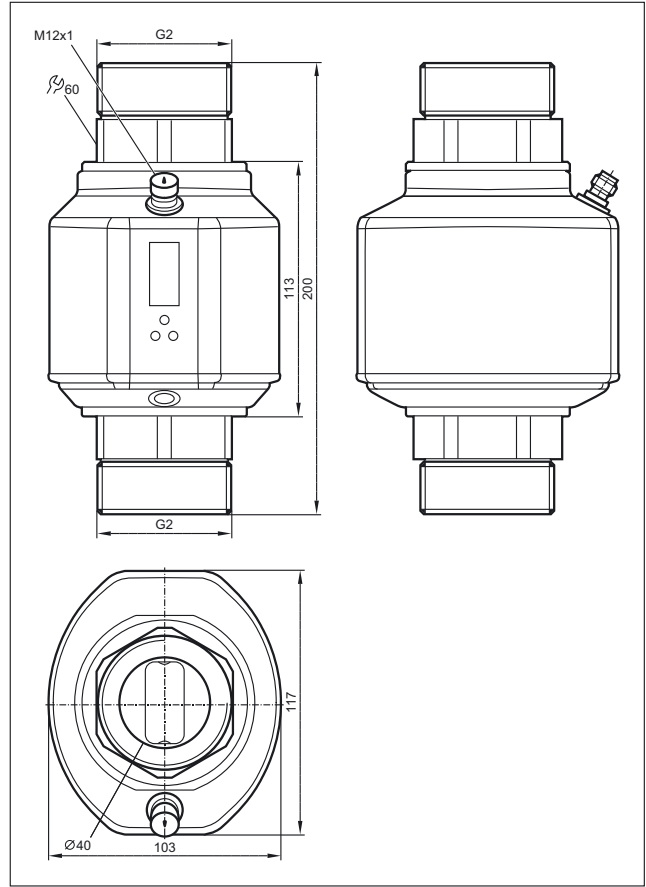

15

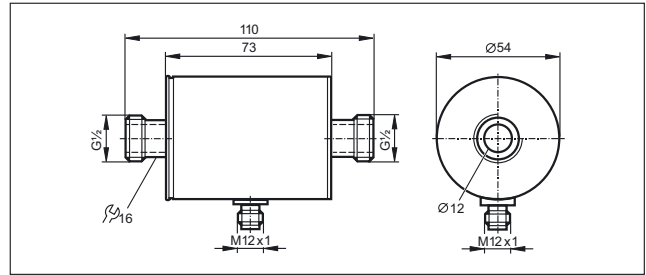

16

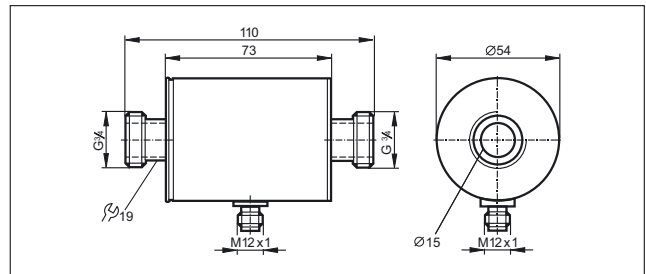

Scale drawings / drawing no. – CAD download: www.ifm.com

17

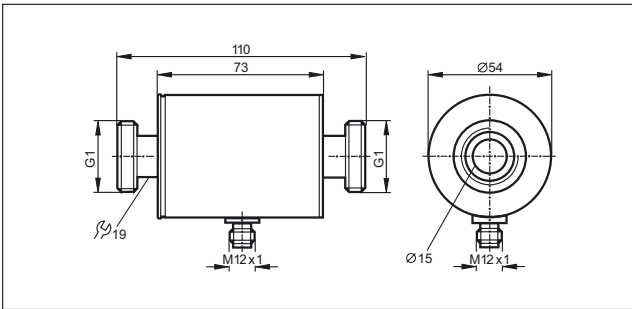

18

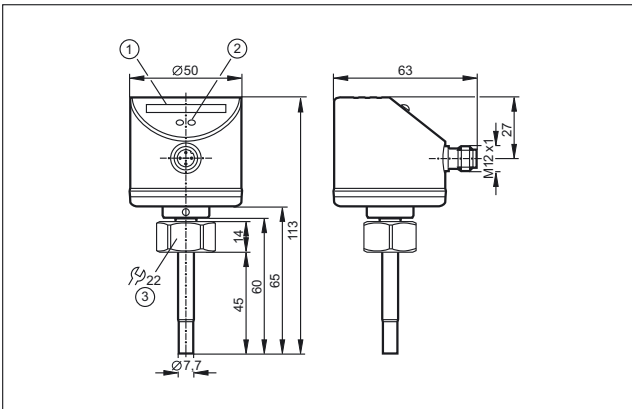

1: LED display, 2: setting pushbutton, 3: tightening torque 25 Nm

19

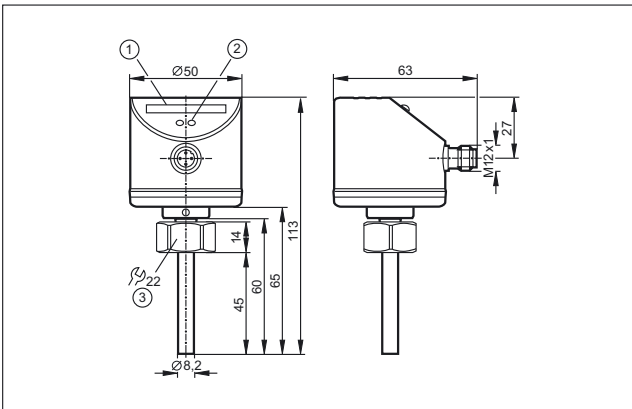

1: LED display, 2: setting pushbutton, 3: tightening torque 25 Nm

20

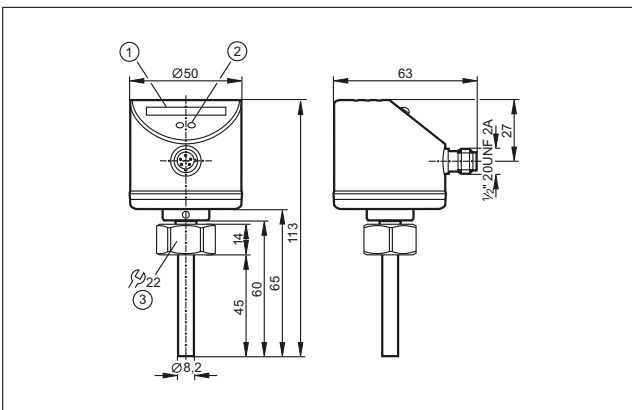

1: LED display, 2: setting pushbutton, 3: tightening torque 25 Nm

21

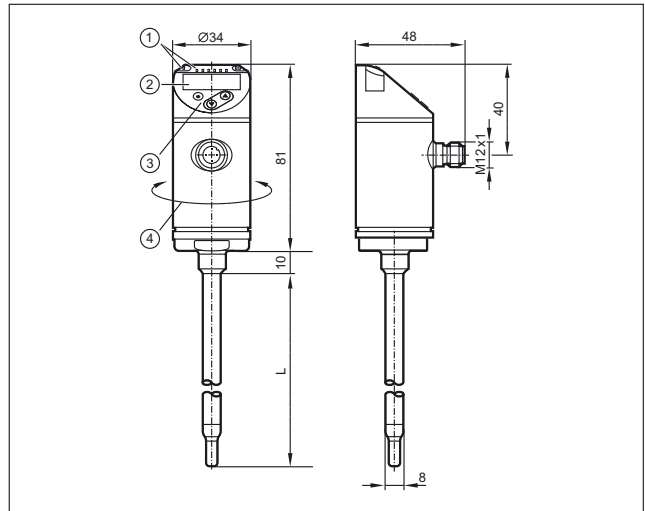

22

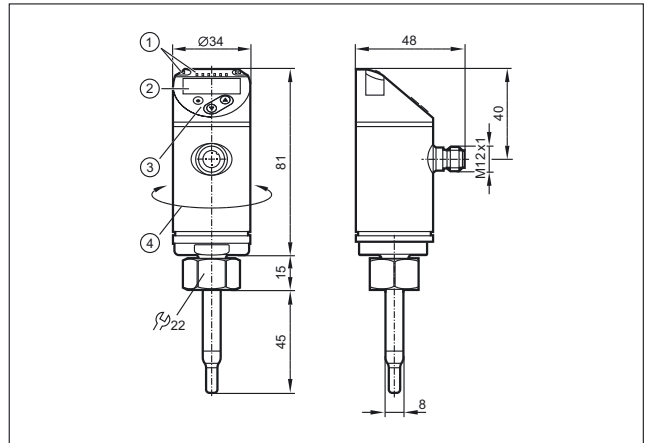

23

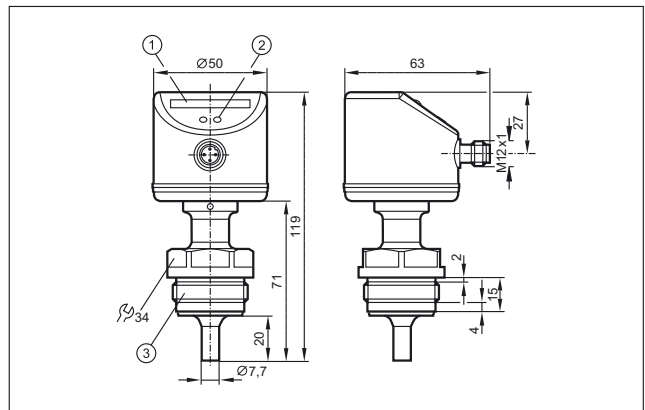

1: LED display, 2: setting pushbutton, 3: G1/Aseptoflex Vario thread

Scale drawings / drawing no. – CAD download: www.ifm.com

24

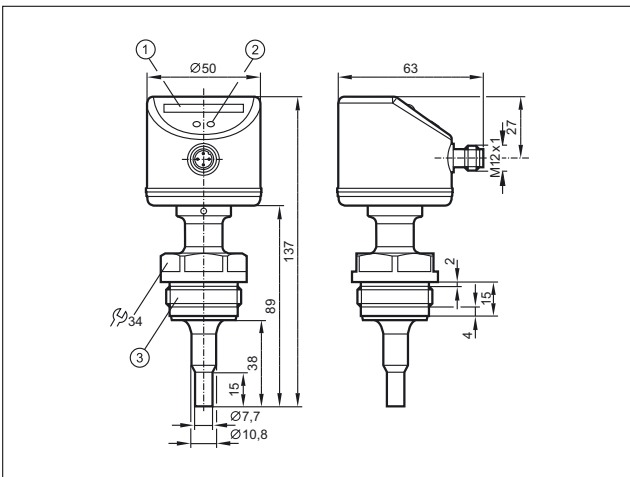

1: LED display, 2: setting pushbutton, 3: G1/Aseptoflex Vario thread

25

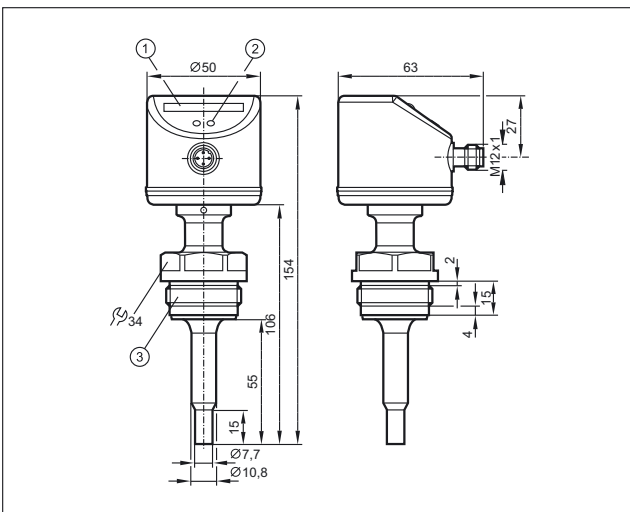

1: LED display, 2: setting pushbutton, 3: G1/Aseptoflex Vario thread

26

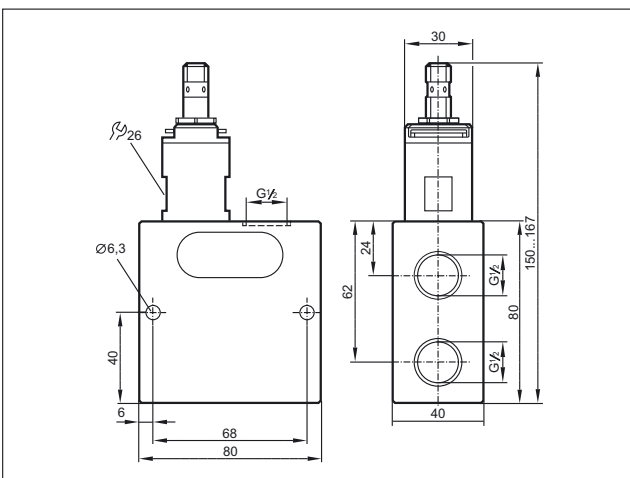

27

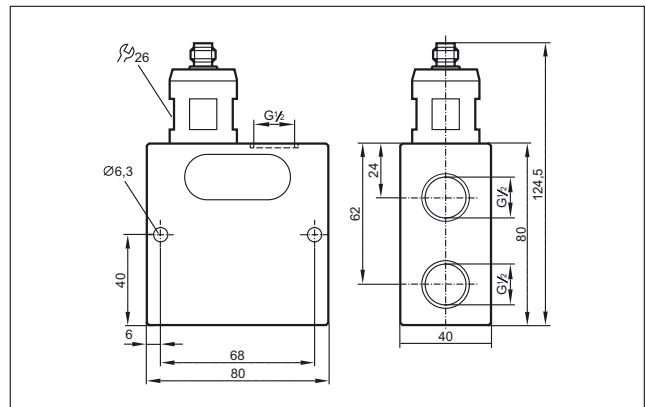

28

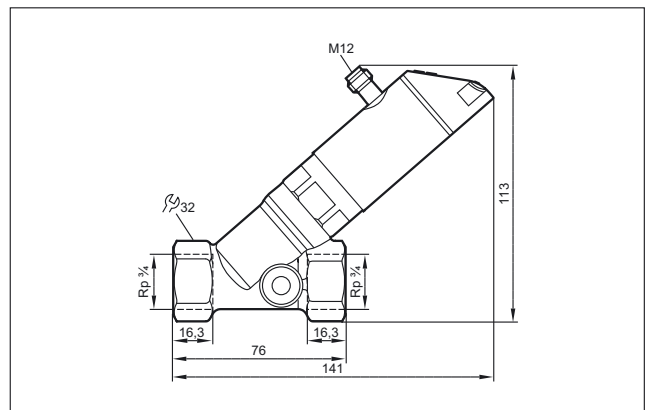

29

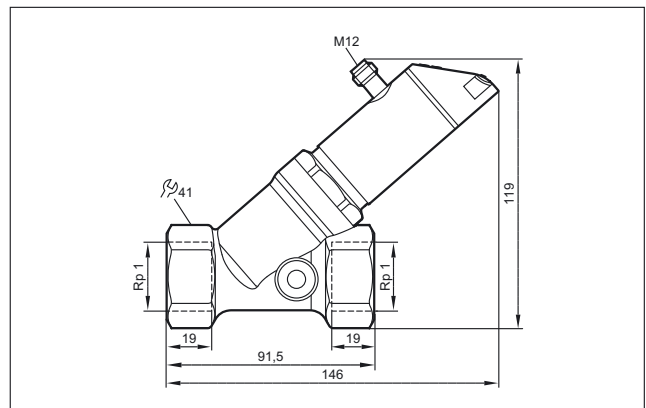

30

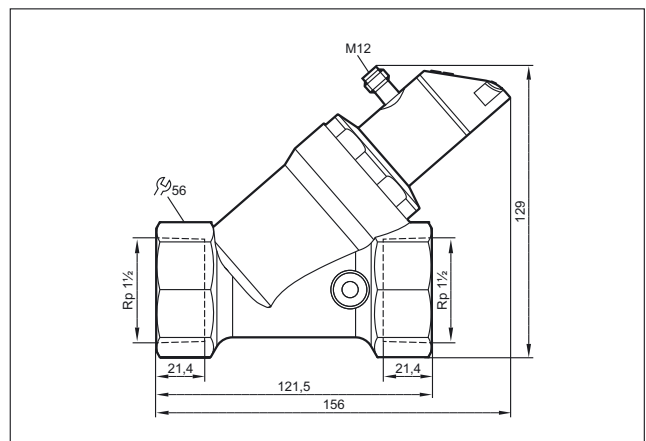

Scale drawings / drawing no. – CAD download: www.ifm.com

31

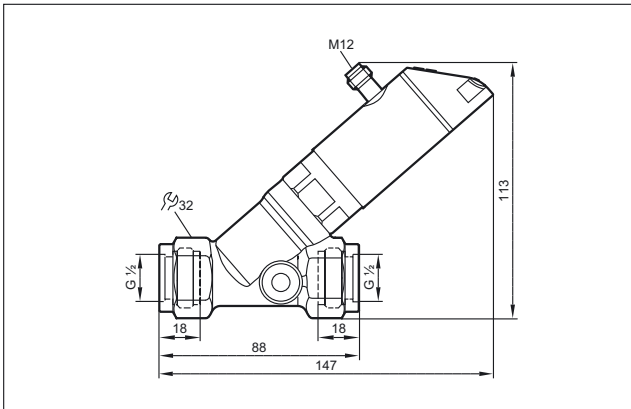

32

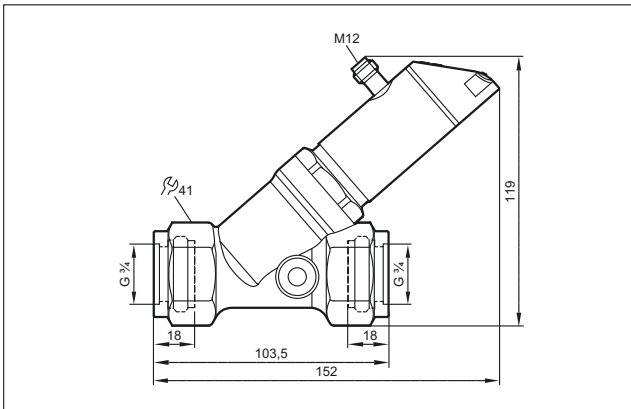

33

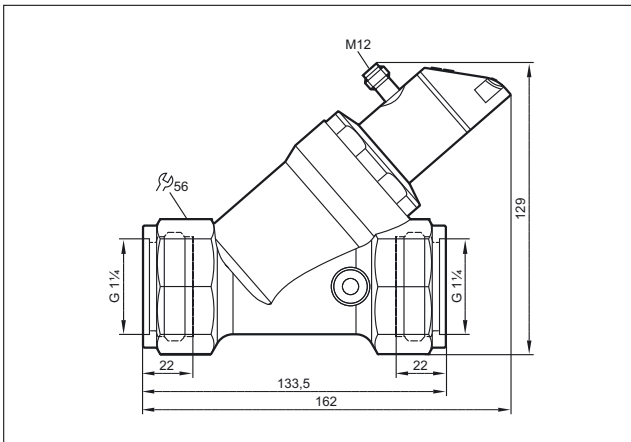

34

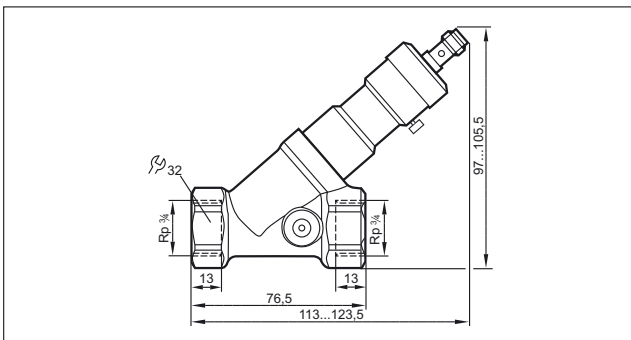

35

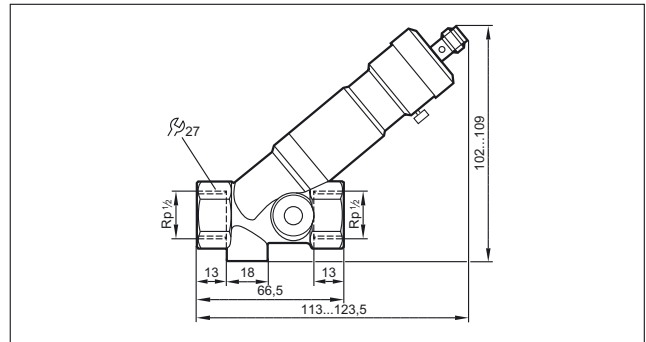

36

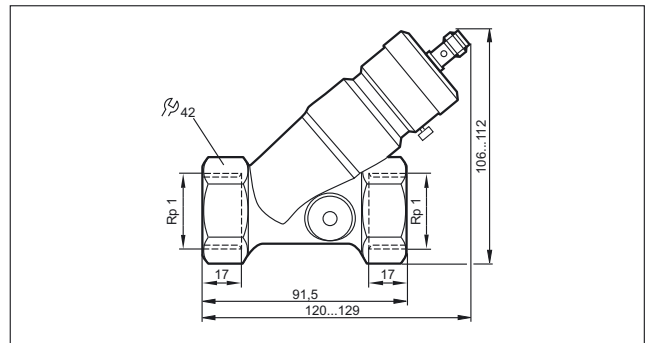

37

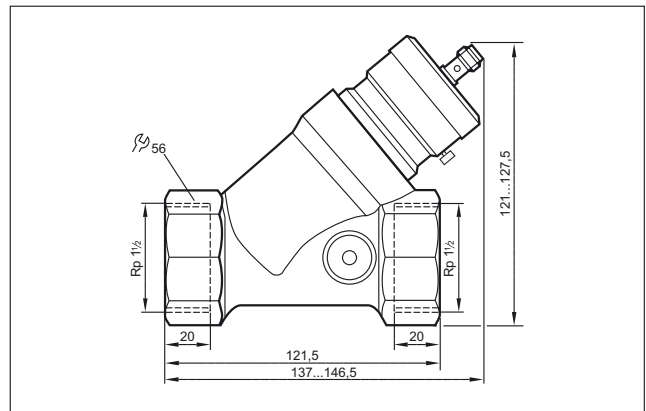

38

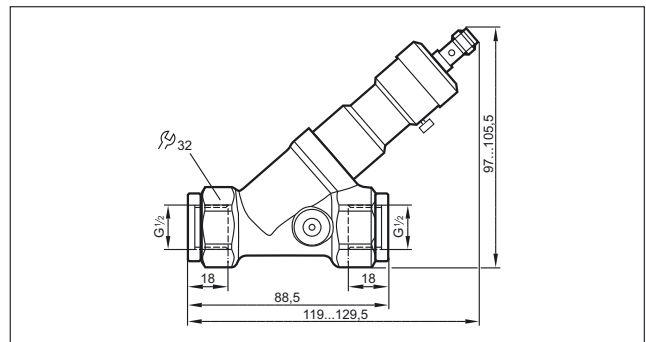

Scale drawings / drawing no. – CAD download: www.ifm.com

39

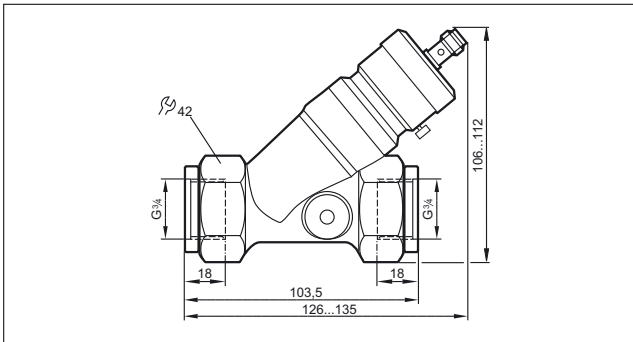

43

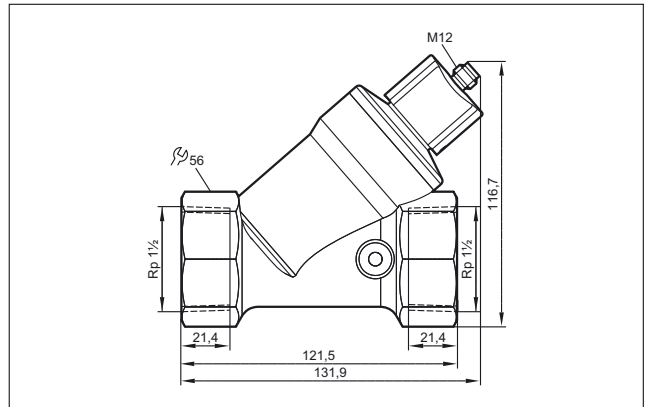

40

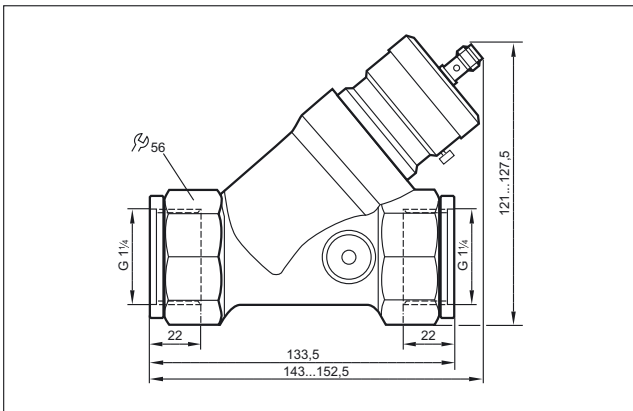

44

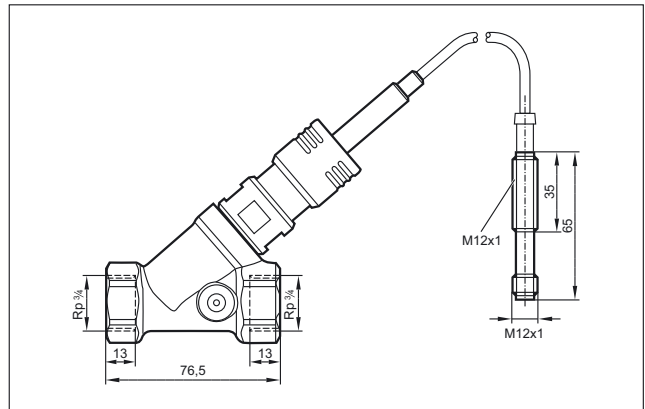

41

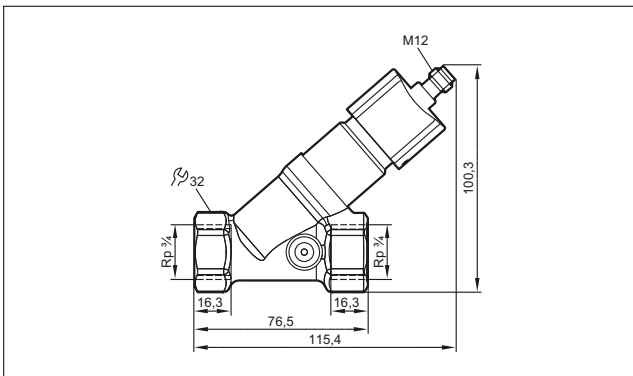

45

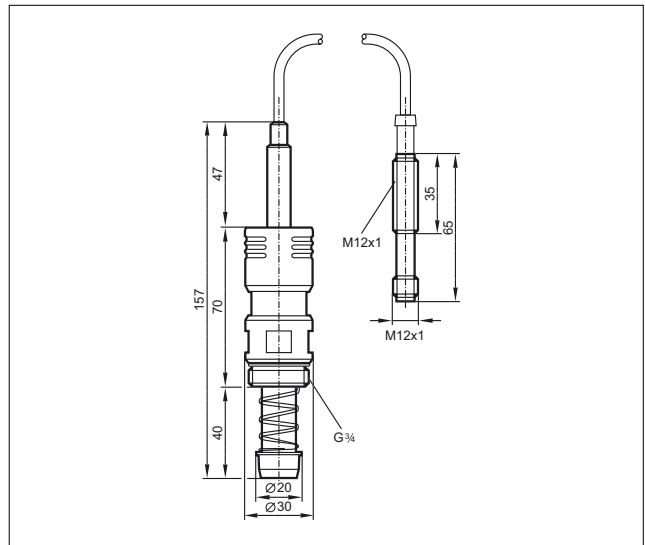

42

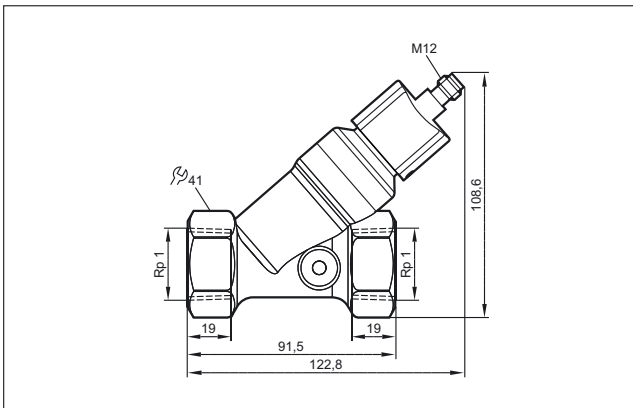

46

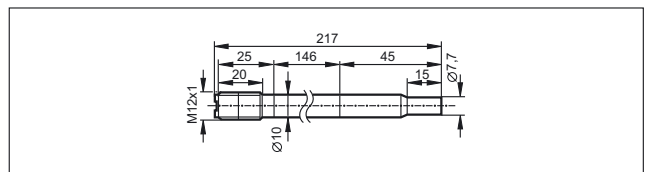

Scale drawings / drawing no. – CAD download: www.ifm.com

47

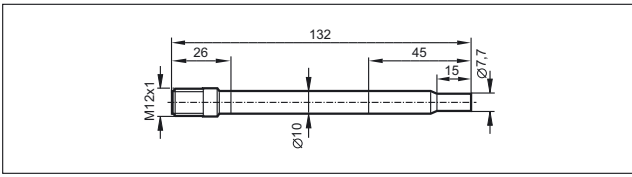

48

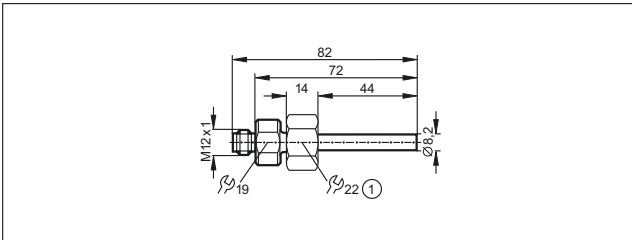

1: internal thread M18 x 1.5

49

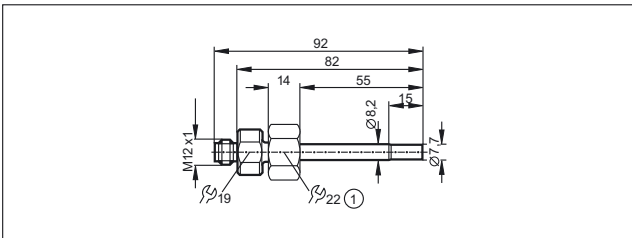

internal thread M18 x 1.5

50

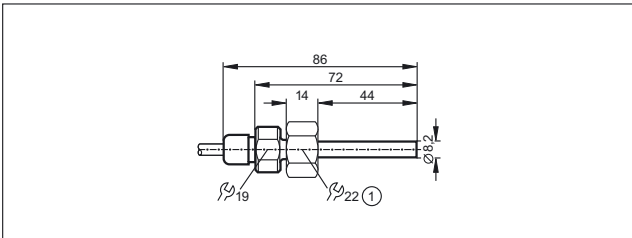

1: internal thread M18 x 1.5

51

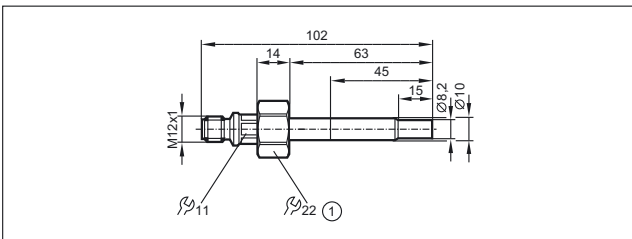

1: internal thread M18 x 1.5

52

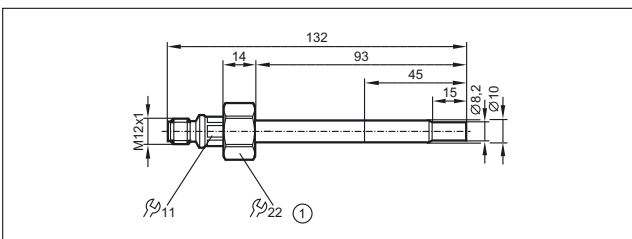

1: internal thread M18 x 1.5

53

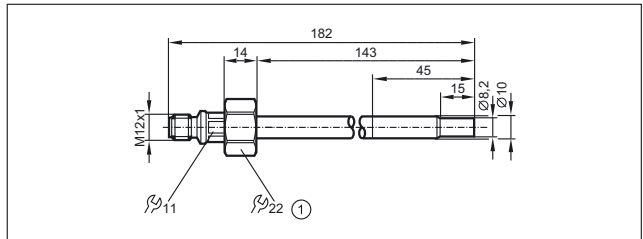

1: internal thread M18 x 1.5

54

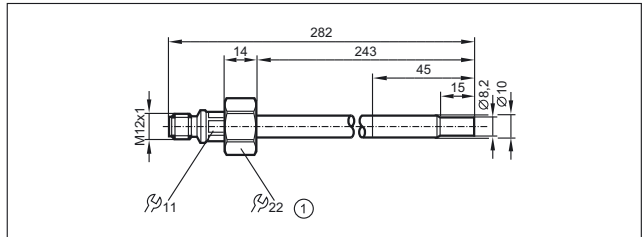

1: internal thread M18 x 1.5

55

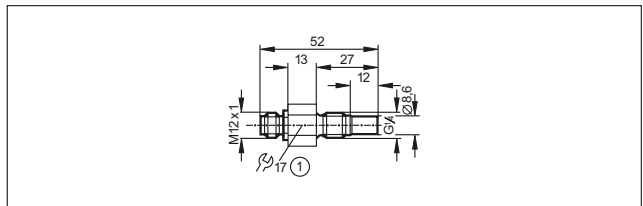

1: tightening torque max. 8 Nm

56

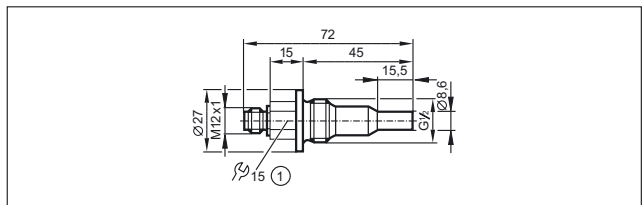

1: tightening torque max. 30 Nm

57

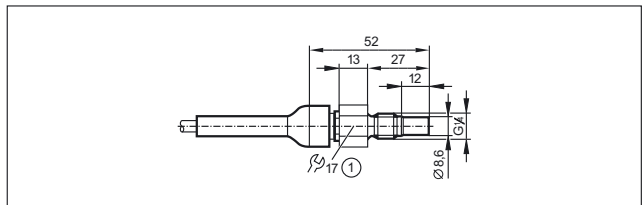

1: tightening torque max. 8 Nm

58

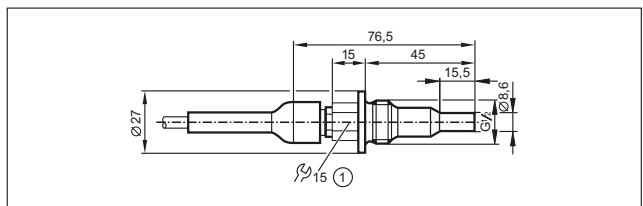

1: tightening torque max. 30 Nm

Scale drawings / drawing no. – CAD download: www.ifm.com

59

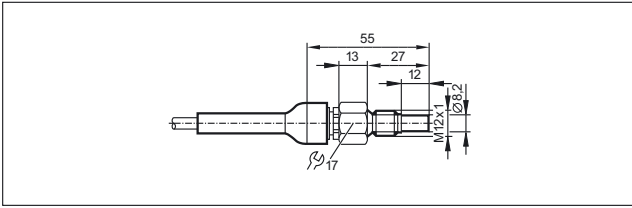

60

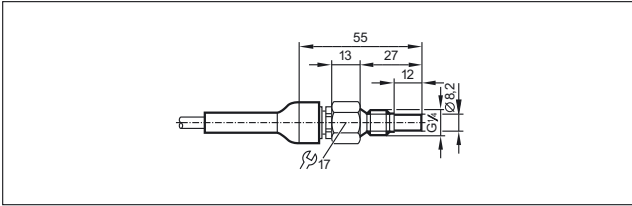

61

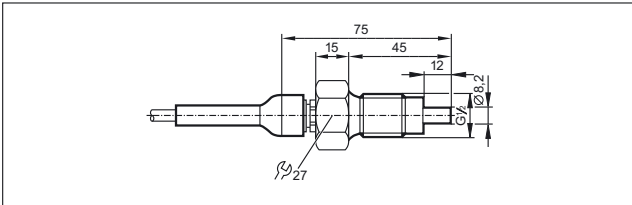

62

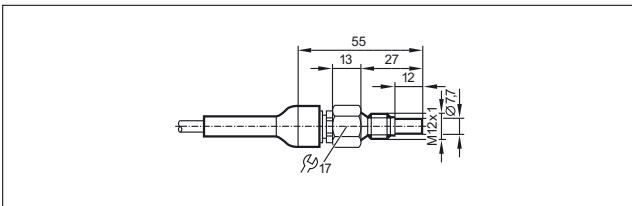

63

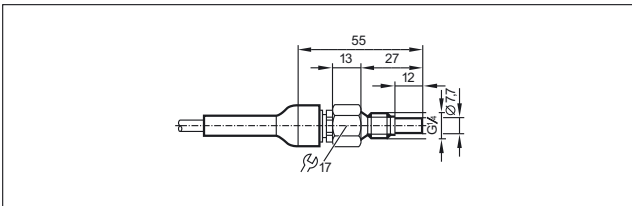

64

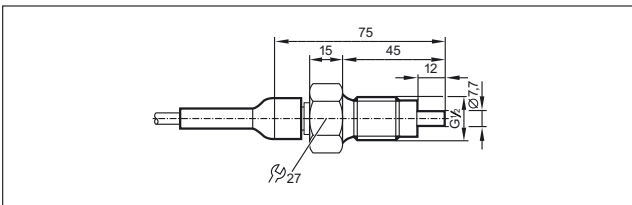

65

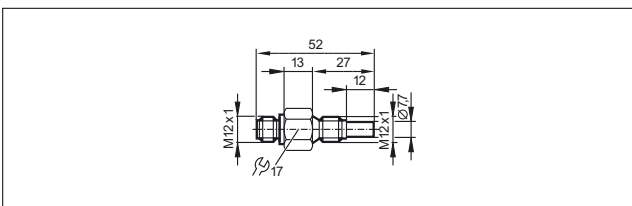

66

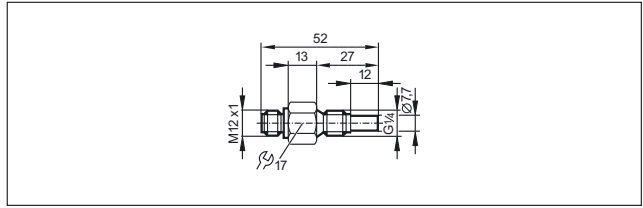

67

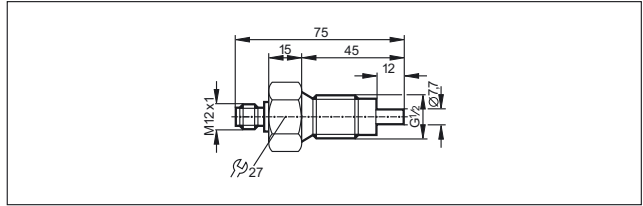

68

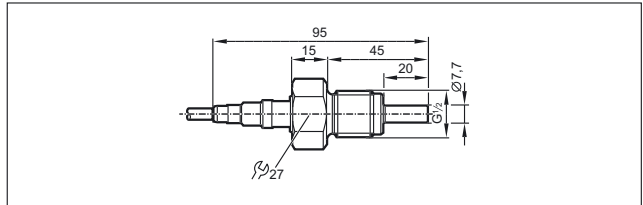

69

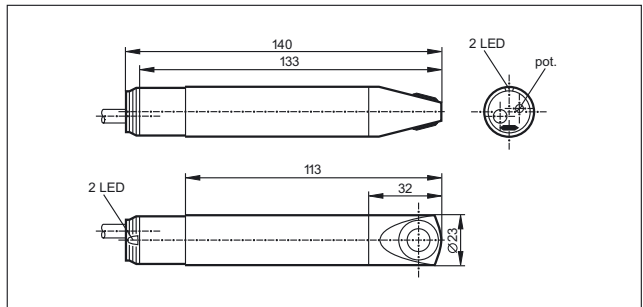

70

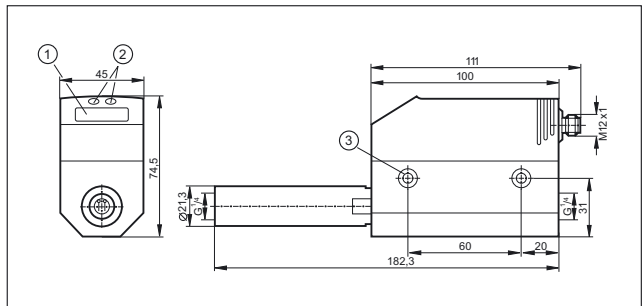

1: 4-digit alphanumeric display, 2: Programming buttons, 3: hole for M5 fixing screw

Scale drawings / drawing no. – CAD download: www.ifm.com

71

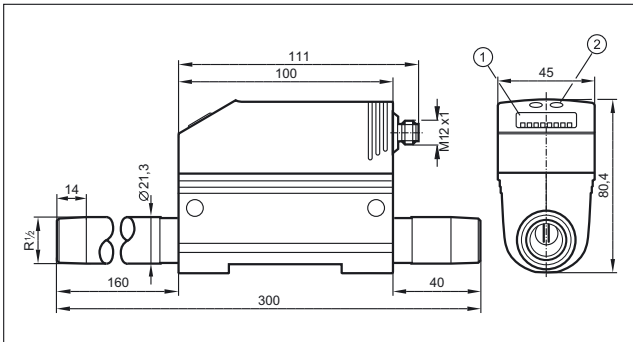

1: 4-digit alphanumeric display, 2: Programming buttons

72

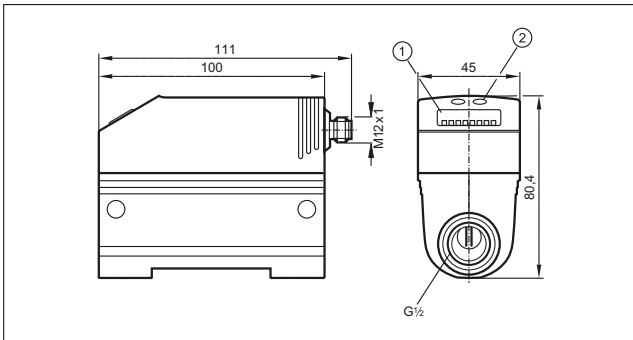

1: 4-digit alphanumeric display, 2: Programming buttons

73

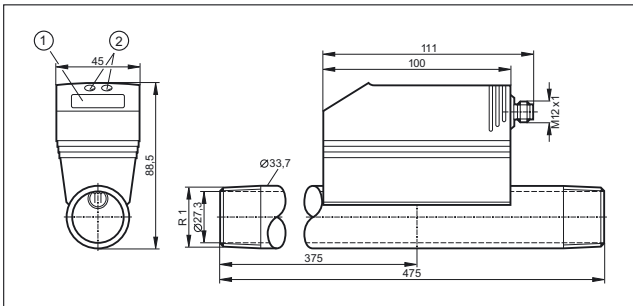

1: 4-digit alphanumeric display, 2: Programming buttons

74

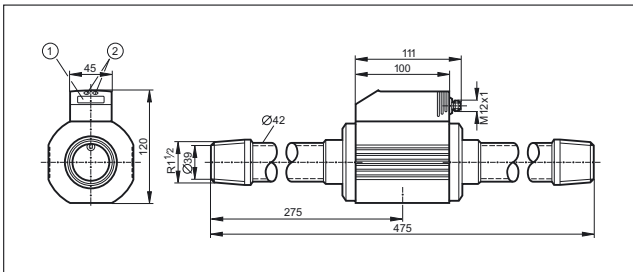

1: 4-digit alphanumeric display, 2: Programming buttons

75

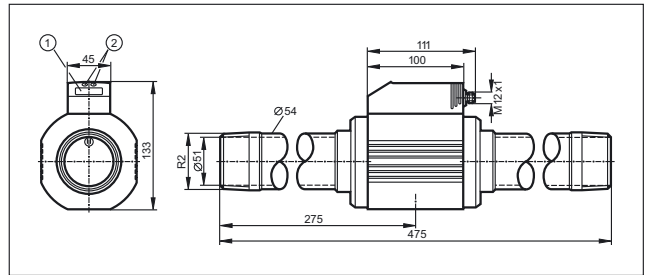

1: 4-digit alphanumeric display, 2: Programming buttons

76

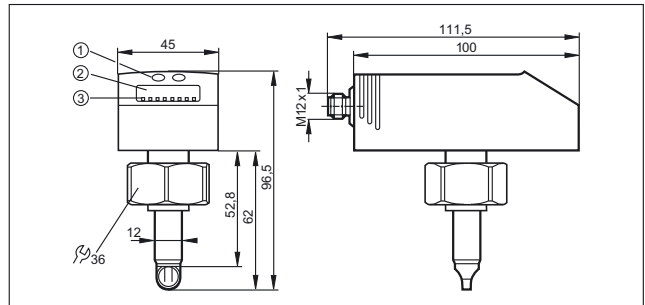

1: Programming buttons, 2: 4-digit alphanumeric display, 3: LEDs

77

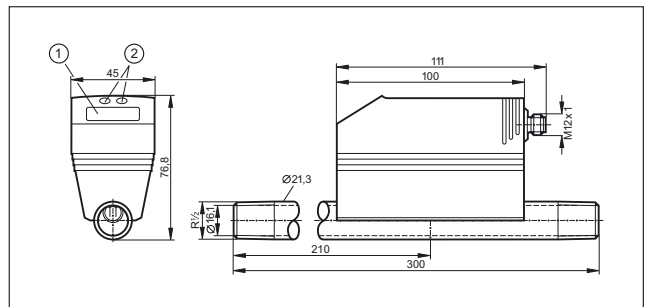

1: 4-digit alphanumeric display, 2: Programming buttons

78

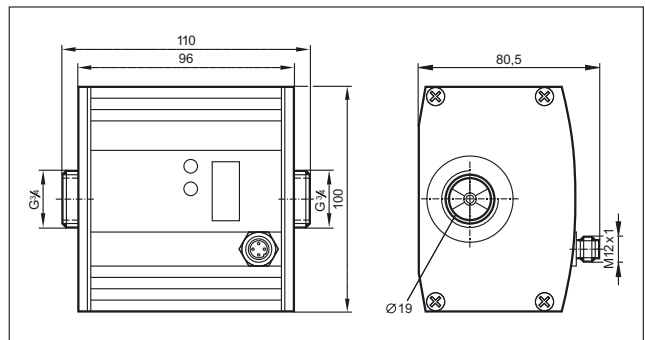

installation length with pipe adapter E40151 / E40154: 185 mm

Scale drawings / drawing no. – CAD download: www.ifm.com

79

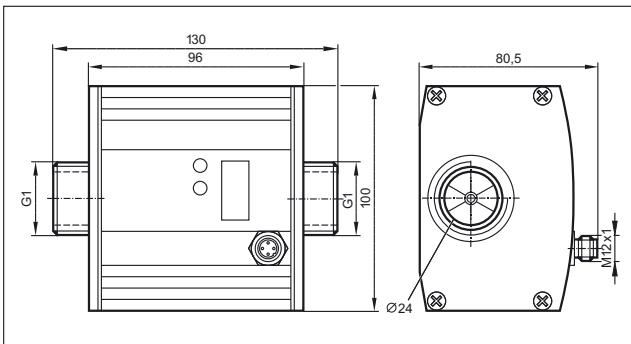

installation length with pipe adapter E40152 / E40155: 205 mm,
 installation length with pipe adapter E40153 / E40156: 215 mm

80

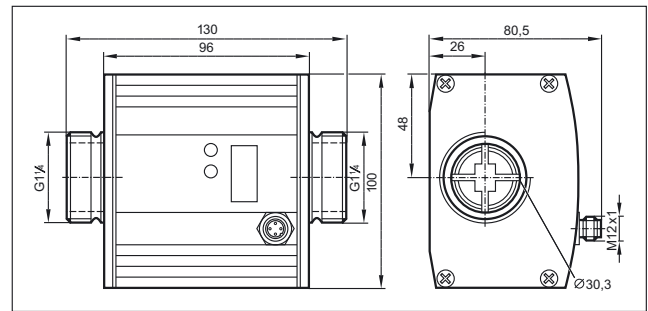



- Guided wave radar, capacitive and hydrostatic level sensors
- Designed for common industrial and process fluids
- No moving parts means high reliability and long service life
- Outputs for continuous or point level measurement
- Integrated LED display for local indication

Level sensors

ifm offers a range of level sensing technologies to suit a wide variety of level monitoring applications. From monitoring simple automatic filling system and overflow prevention sensors to continuous process control ifm level sensors can give an effective solution to your application requirements.

Advantages of electronic sensors

Level monitoring systems that rely on mechanical movement are prone to erratic behaviour and failure. Simple wear and tear or the build-up of deposits can cause mechanical devices to stick or break apart. Electronic sensors from ifm have no moving parts and evaluate level using either guided wave radar, capacitance or hydrostatic pressure. This makes ifm's sensors especially robust and reliable.

Other advantages of electronic sensors are the local indication of the level and the easy setting of output function, such as the switch point.

Measurement principles

Continuous level sensors from ifm use one of four different physical measuring principles: For capacitive measurement the probe and the tank form an electrical capacitor. The capacitance changes with the level and is converted into a level measurement by a microprocessor. For hydrostatic level measurement a measuring cell detects the hydrostatic pressure of the medium. Here the pressure change is a measure for the level. The efcator gwr level sensor operates on the principle of guided wave radar. Electromagnetic pulses are transmitted by the sensor head and guided along the probe. When the microwave pulse hits the medium to be detected, it is reflected and the elapsed time is evaluated by the sensor.

Point levels can be set on many of the units using any of the three technologies above. The LM family adds a fourth; impedance spectroscopy is used to generate reliable switch points while ignoring foam and product residue sticking to the probe.



Point level switches make direct contact with the medium to be monitored.

For special applications: Level sensor mounted in the top of a tank.





System overview	Page
Electronic level sensors for oils and coolants, approval to the German Federal Water Act (WHG), section 19	508
Electronic level sensors for oils and coolants	508 - 509
Point level sensors for oils and coolants, approval to the German Federal Water Act (WHG), section 19	509
Point level sensors for oils and lubricants	510
Point level sensors for oils and coolants, approval to the German Federal Water Act (WHG), section 19	510
Point level sensors for hygienic areas, approval to the German Federal Water Act WHG section 19	511
Variable level sensors, guided wave radar, hygienic areas	511
Variable level sensors, guided wave radar, industrial applications	511 - 512
Compact sensors for level and temperature monitoring	512
Compact sensors for level and leakage monitoring	513
Sensors for hydrostatic level monitoring	513 - 514
Sensors for hydrostatic level monitoring ATEX category 1G/1D	514
Sensors for hydrostatic level monitoring in hygienic and wet areas	514 - 516
Accessories for level sensors LK, LT, LL, LI	516 - 517
Parameter-setting system	517 - 518
Certificates	518
Accessories for level sensors LM	518 - 519
Accessories 3A	519 - 520
Accessories for level sensors LR	520
LR probes for standard applications	520 - 521
LR probes for hygienic areas	521
LR coaxial pipes	522 - 523
Hygienic adapters	523
Accessories for level sensors PA, PG, PI, PN, PS, PY	524
Wiring diagrams	524 - 525
Scale drawings / drawing no. – CAD download: www.ifm.com	525 - 528

Electronic level sensors for oils and coolants, approval to the German Federal Water Act (WHG), section 19

Type	Probe length [mm]	Active zone [mm]	Inactive zone [mm]	U _b [V]	Medium temperature water [°C]	Medium temperature oil [°C]	I _{load} [mA]	Drawing no.	Order no.
------	----------------------	---------------------	-----------------------	-----------------------	----------------------------------	--------------------------------	---------------------------	-------------	-----------

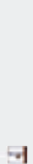
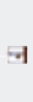

M12 connector · Output function 1 x normally open / closed programmable (OUT1) 1 x normally closed (OUT-OP, overflow output) · DC PNP · Wiring diagram no. 1 · Connector groups 8, 9, 10, 11, 18, 20, 120, 124, 126, 128, 130, 131, 157, 158

	264	195	53 / 15	12...30	0...35	0...65	200	1	LK1222
	472	390	53 / 30	12...30	0...35	0...65	200	1	LK1223
	728	585	102 / 40	12...30	0...35	0...65	200	1	LK1224

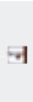

Electronic level sensors for oils and coolants

Type	Probe length [mm]	Active zone [mm]	Inactive zone [mm]	U _b [V]	Medium temperature water [°C]	Medium temperature oil [°C]	I _{load} [mA]	Drawing no.	Order no.
------	----------------------	---------------------	-----------------------	-----------------------	----------------------------------	--------------------------------	---------------------------	-------------	-----------



M12 connector (according to EN 61076-2-101) · Output function 1 x analogue 4...20 mA / 0...10 V (OUT2); 1 x normally open / closed programmable (OUT-OP) · DC PNP · Wiring diagram no. 2 · Connector groups 8, 10, 18, 20, 120, 124, 126, 128, 157

	264	195	53 / 15	18...30	0...35 (LK3122 + E43100: 0...65)	0...70	200	2	LK3122
	472	390	53 / 30	18...30	0...35 (LK3123 + E43101: 0...60)	0...70	200	2	LK3123
	728	585	102 / 40	18...30	0...35 (LK3124 + E43102: 0...55)	0...70	200	2	LK3124

M12 connector (according to EN 61076-2-101) · Output function 2 x normally open / closed programmable · DC PNP · Wiring diagram no. 3 · Connector groups 8, 9, 10, 11, 18, 20, 120, 124, 126, 128, 130, 131, 157, 158

	264	195	53 / 15	18...30	0...35 (LK1022 + E43100: 0...65)	0...70	200	2	LK1022
	472	390	53 / 30	18...30	0...35 (LK1023 + E43101: 0...60)	0...70	200	2	LK1023
	728	585	102 / 40	18...30	0...35 (LK1024 + E43102: 0...55)	0...70	200	2	LK1024

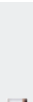
M12 connector · Output function 2 x normally open / closed programmable · DC PNP · Wiring diagram no. 3 · Connector groups 8, 9, 10, 11, 18, 20, 120, 124, 126, 128, 130, 131, 157, 158

	264	195	53 / 15	12...30	–	0...65	200	1	LK7022
	472	390	53 / 30	12...30	0...60	0...65	200	1	LK7023

Type	Probe length [mm]	Active zone [mm]	Inactive zone [mm]	U _b [V]	Medium temperature water [°C]	Medium temperature oil [°C]	I _{load} [mA]	Drawing no.	Order no.
------	----------------------	---------------------	-----------------------	-----------------------	----------------------------------	--------------------------------	---------------------------	-------------	-----------

M12 connector · Output function 2 x normally open / closed programmable · DC PNP · Wiring diagram no. 3 · Connector groups 8, 9, 10, 11, 18, 20, 120, 124, 126, 128, 130, 131, 157, 158

	728	585	102 / 40	12...30	0...55	0...65	200	1	LK7024
---	-----	-----	----------	---------	--------	--------	-----	---	--------

M12 connector (according to EN 61076-2-101) · Output function 3 x normally open / closed programmable (OUT1...OUT3); 1 x normally open / closed programmable (OUT-OP) · DC PNP · Wiring diagram no. 4 · Connector groups 16, 17

	264	195	53 / 15	18...30	0...35 (LK8122 + E43100: 0...65)	0...70	200	3	LK8122
---	-----	-----	---------	---------	----------------------------------	--------	-----	---	--------

	472	390	53 / 30	18...30	0...35 (LK8123 + E43101: 0...60)	0...70	200	3	LK8123
---	-----	-----	---------	---------	----------------------------------	--------	-----	---	--------

	728	585	102 / 40	18...30	0...35 (LK8124 + E43102: 0...55)	0...70	200	3	LK8124
---	-----	-----	----------	---------	----------------------------------	--------	-----	---	--------

Point level sensors for oils and coolants, approval to the German Federal Water Act (WHG), section 19

Type	Probe length [mm]	Output	U _b [V]	Medium temperature water [°C]	Medium temperature oil [°C]	I _{load} [mA]	Drawing no.	Order no.
------	----------------------	--------	-----------------------	----------------------------------	--------------------------------	---------------------------	-------------	-----------

M12 connector · Output function  · DC PNP · Wiring diagram no. 5 · Connector groups 8, 10, 11, 18, 20, 120, 124, 126, 128, 130, 157, 158

	132	Normally closed	10...36	0...35	0...65	200	4	LI2141
	273	Normally closed	10...36	0...35	0...65	200	4	LI2142
	481	Normally closed	10...36	0...35	0...65	200	4	LI2143
	132	Normally closed	10...36	0...35	0...65	200	4	LI2241
	273	Normally closed	10...36	0...35	0...65	200	4	LI2242
	481	Normally closed	10...36	0...35	0...65	200	4	LI2243

Point level sensors for oils and lubricants

Type	Probe length [mm]	Output	U _b [V]	Medium temperature water [°C]	Medium temperature oil [°C]	I _{load} [mA]	Drawing no.	Order no.
------	----------------------	--------	-----------------------	----------------------------------	--------------------------------	---------------------------	-------------	-----------

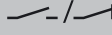

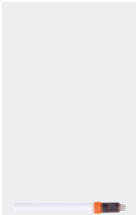

M12 connector · Output function  · DC PNP · Wiring diagram no. 5 · Connector groups 8, 10, 11, 18, 20, 120, 124, 126, 128, 130, 157, 158

	132	normally open / closed programmable	10...36	0...35 (LI5141 + E43103: 0...65)	0...65	200	4	LI5141
	273	normally open / closed programmable	10...36	0...35 (LI5142 + E43100: 0...65)	0...65	200	4	LI5142
	481	normally open / closed programmable	10...36	0...35 (LI5143 + E43101: 0...60)	0...65	200	4	LI5143
	737	normally open / closed programmable	10...36	0...35 (LI5144 + E43102: 0...55)	0...65	200	4	LI5144





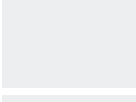

Point level sensors for oils and coolants, approval to the German Federal Water Act (WHG), section 19

Type	Process connection	Output	U _b [V]	Medium temperature water [°C]	Medium temperature oil [°C]	I _{load} [mA]	Drawing no.	Order no.
------	--------------------	--------	-----------------------	----------------------------------	--------------------------------	---------------------------	-------------	-----------

M12 connector · Output function 1 x NO / 1 x NC (WHG) · DC PNP · Wiring diagram no. 6 · Connector groups 8, 9, 10, 11, 18, 20, 120, 124, 126, 128, 130, 131, 157, 158

	G ½ A	1 x NO / 1 x NC (WHG) PNP	18...30	-40...85 / (0...85)	-40...100 / (0...100)	100	5	LMT191
	G ½ A	1 x NO / 1 x NC (WHG) PNP	18...30	-25...85 / (0...85)	-25...100 / (0...100)	100	6	LMT192
	G ½ A	1 x NO / 1 x NC (WHG) PNP	18...30	-25...85 / (0...85)	-25...100 / (0...100)	100	7	LMT194
	G ½ A	1 x NO / 1 x NC (WHG) PNP	18...30	-25...85 / (0...85)	-25...100 / (0...100)	100	8	LMT195
	G ¾ A	1 x NO / 1 x NC (WHG) PNP	18...30	-25...85 / (0...85)	-25...100 / (0...100)	100	9	LMT292
	G 1 A	1 x NO / 1 x NC (WHG) PNP	18...30	-25...85 / (0...85)	-25...100 / (0...100)	100	10	LMT392

Point level sensors for hygienic areas, approval to the German Federal Water Act (WHG) section 19

Type	Process connection	Output	U _b [V]	Medium temperature water [°C]	Medium temperature oil [°C]	I _{load} [mA]	Drawing no.	Order no.
M12 connector · Output function 2 x normally open / closed programmable · DC PNP/NPN · Wiring diagram no. 7 · Connector groups 8, 9, 10, 11, 18, 20, 120, 124, 126, 128, 130, 131, 157, 158								
	G ½ A	2 x normally open / closed programmable PNP/NPN	18...30	-40...85	-40...100	100	5	LMT100
	G ½ A	2 x normally open / closed programmable PNP/NPN	18...30	-20...85	-20...100	100	6	LMT102
	G ½ A	2 x normally open / closed progr. PNP/NPN	18...30	-20...85	-20...100	100	7	LMT104
	G ½ A	2 x normally open / closed progr. PNP/NPN	18...30	-20...85	-20...100	100	8	LMT105
	G ½ A	2 x normally open / closed progr. PNP/NPN	18...30	-40...85	-40...100	100	5	LMT110
	G ½ A	2 x normally open / closed progr. PNP/NPN	18...30	-40...85	-40...100	100	5	LMT121
	G ¾ A	2 x normally open / closed programmable PNP/NPN	18...30	-20...85	-20...100	100	9	LMT202
	G 1 A	2 x normally open / closed programmable PNP/NPN	18...30	-20...85	-20...100	100	10	LMT302

Variable level sensors, guided wave radar, hygienic areas

Type	Process connection	Probe length [mm]	Active zone [mm]	Inactive zone [mm]	U _b [V]	Medium temperature [°C]	I _{load} [mA]	Drawing no.	Order no.
M12 connector (according to EN 61076-2-101) · Output function OUT1: normally open / closed programmable / IO-Link OUT2: normally open / closed programmable or analogue (4...20 mA scaleable, invertable) · DC PNP/NPN · Wiring diagram no. 7 · Connector groups 8, 10, 18, 20, 120, 124, 126, 128, 157									
	Aseptoflex Vario	150...2000	L-40	30 / 10	18...30	-40...150	150	11	LR2750

Variable level sensors, guided wave radar, industrial applications

Type	Process connection	Probe length [mm]	Active zone [mm]	Inactive zone [mm]	U _b [V]	Medium temperature [°C]	I _{load} [mA]	Drawing no.	Order no.
M12 connector (according to EN 61076-2-101) · Output function OUT1: normally open / closed programmable / IO-Link OUT2: normally open / closed programmable or analogue (4...20 mA scaleable, invertable) · DC PNP/NPN · Wiring diagram no. 7 · Connector groups 8, 10, 18, 20, 120, 124, 126, 128, 157									
	G ¾ A	150...2000	L-40 / (L-60)	30 / 10 (30)	18...30	-20...100	150	12	LR2050

Process sensors

Type	Process connection	Probe length [mm]	Active zone [mm]	Inactive zone [mm]	U _b [V]	Medium temperature [°C]	I _{load} [mA]	Draw- ing no.	Order no.
M12 connector (according to EN 61076-2-101) · Output function normally open / closed programmable; 4...20 mA or 0...10 V · DC PNP · Wiring diagram no. 8 · Connector groups 8, 10, 18, 20, 120, 124, 126, 128, 157									
	G 3/4 A	100...1600	L-40 (L-60)	30 / 10 (30)	18...30	0...80	200	13	LR3000
	3/4" NPT	100...1600	L-40	30 / 10	18...30	0...80	200	14	LR3300
M12 connector (according to EN 61076-2-101) · Output function 2 x normally open / closed programmable · DC PNP · Wiring diagram no. 8 · Connector groups 8, 10, 18, 20, 120, 124, 126, 128, 157									
	G 3/4 A	100...1600	L-40 (L-60)	30 / 10 (30)	18...30	0...80	200	13	LR7000
	3/4" NPT	100...1600	L-40	30 / 10	18...30	0...80	200	14	LR7300
M12 connector (according to EN 61076-2-101) · Output function 4 x normally open / closed programmable · DC PNP · Wiring diagram no. 9 · Connector groups 16, 17									
	G 3/4 A	100...1600	L-40 (L-60)	30 / 10 (30)	18...30	0...80	200	15	LR8000
	3/4" NPT	100...1600	L-40	30 / 10	18...30	0...80	200	16	LR8300
M12 connector (according to EN 61076-2-101) · DC PNP · Wiring diagram no. 7 · Connector groups 8, 10, 18, 20, 120, 124, 126, 128, 157									
	G 3/4 A	100...1600	L-40 (L-60)	30 / 10 (30)	18...30	0...80	–	17	LR9020

Compact sensors for level and temperature monitoring

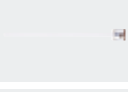
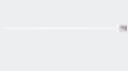
Type	Probe length [mm]	Active zone [mm]	Inactive zone [mm]	U _b [V]	Medium temperature water [°C]	Medium temperature oil [°C]	I _{load} [mA]	Draw- ing no.	Order no.
M12 connector (according to EN 61076-2-101) · Output function 2 x normally open / closed programmable (level) 2 x normally open / closed programmable (temperature) · DC PNP · Wiring diagram no. 10 · Connector groups 16, 17									
	264	195	53 / 15	18...30	–	0...70	200	18	LT8022
	472	390	53 / 30	18...30	–	0...70	200	18	LT8023
	728	585	102 / 40	18...30	–	0...70	200	18	LT8024

Compact sensors for level and leakage monitoring

Type	Probe length [mm]	Active zone [mm]	Inactive zone [mm]	U _b [V]	Medium temperature water [°C]	Medium temperature oil [°C]	I _{load} [mA]	Drawing no.	Order no.
------	----------------------	---------------------	-----------------------	-----------------------	----------------------------------	--------------------------------	---------------------------	-------------	-----------

M12 connector (according to EN 61076-2-101) · Output function 4 x normally open / closed programmable · DC PNP · Wiring diagram no. 11 · Connector groups 16, 17

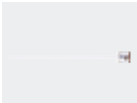
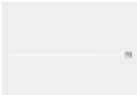
	264	195	53 / 15	18...30	0...35 (LL8022 + E43100: 0...65)	0...70	200	18	LL8022
	472	390	53 / 30	18...30	0...35 (LL8023 + E43101: 0...60)	0...70	200	18	LL8023
	728	585	102 / 40	18...30	0...35 (LL8024 + E43102: 0...55)	0...70	200	18	LL8024

Sensors for hydrostatic level monitoring

Type	Measuring range [bar]	Cable length / material	P _{overload} max. [bar]	P _{bursting} min. [bar]	U _b DC [V]	Drawing no.	Order no.
------	--------------------------	-------------------------	-------------------------------------	-------------------------------------	--------------------------	-------------	-----------

Output function 4...20 mA analogue · Wiring diagram no. 12

	0...0.25	5 m PUR cable	2	2.4	10...30	19	PS3208
	0...0.6	10 m PUR cable	4	4.8	10...30	19	PS3407
	0...0.6	15 m PUR cable	4	4.8	10...30	19	PS3427
	0...1	15 m PUR cable	5	6	10...30	19	PS3417
	0...0.6	30 m PUR cable	4	4.8	10...30	19	PS3607
	0...1	30 m PUR cable	5	6	10...30	19	PS3617

Output function 4...20 mA analogue · Wiring diagram no. 13

	0...0.25	5 m FEP cable	2	2.4	10...30	20	PS4208
	0...0.6	10 m FEP cable	3	4	10...30	20	PS4407

Process sensors

Type	Measuring range [bar]	Cable length / material	P _{overload} max. [bar]	P _{bursting} min. [bar]	U _b DC [V]	Drawing no.	Order no.
------	--------------------------	-------------------------	-------------------------------------	-------------------------------------	-----------------------------	-------------	-----------

· Wiring diagram no. 13

	0...1	15 m FEP cable	5	6	10...30	20	PS4417
---	-------	-------------------	---	---	---------	----	--------

Output function 4...20 mA · Wiring diagram no. 14 · Connector groups 8, 10, 18, 20, 120, 124, 126, 128, 157

	0...0.25	M12 connector	10	30	9.6...32	21	PA3028
---	----------	---------------	----	----	----------	----	--------

	0...0.25	M12 connector	10	30	9.6...32	22	PA3528
---	----------	---------------	----	----	----------	----	--------

Output function 4...20 mA · Wiring diagram no. 15 · Connector groups 8, 10, 18, 20, 120, 124, 126, 128, 157

	0...0.1	M12 connector	4	30	9.6...32	22	PA3589
---	---------	---------------	---	----	----------	----	--------

Sensors for hydrostatic level monitoring ATEX category 1G/1D

Type	Measuring range [bar]	Cable length / material	P _{overload} max. [bar]	P _{bursting} min. [bar]	U _b DC [V]	Drawing no.	Order no.
------	--------------------------	-------------------------	-------------------------------------	-------------------------------------	-----------------------------	-------------	-----------

Output function 4...20 mA analogue · Wiring diagram no. 13

	0...0.25	5 m FEP cable	2	2.4	10...30	20	PS308A
	0...0.6	10 m FEP cable	4	4.8	10...30	20	PS307A
	0...1	15 m FEP cable	5	6	10...30	20	PS317A

Sensors for hydrostatic level monitoring in hygienic and wet areas



Type	Process connection	Display	Measuring range [bar]	P _{overload} max. [bar]	P _{bursting} min. [bar]	U _b DC [V]	Drawing no.	Order no.
------	--------------------	---------	--------------------------	-------------------------------------	-------------------------------------	-----------------------------	-------------	-----------

M12 connector · Output function 1 x normally open / normally closed programmable + 1 x normally open / normally closed programmable or 1 x analogue (4...20 / 20...4 mA, scalable) · Wiring diagram no. 16 · Connector groups 8, 10, 18, 20, 120, 124, 126, 128, 157



	Aseptoflex Vario	Display unit	-0.005...0.1	4	30	20...32	23	PI2789
	Aseptoflex Vario	Display unit	-0.0124...0.25	10	30	20...32	23	PI2798

Type	Process connection	Display	Measuring range [bar]	P _{overload} max. [bar]	P _{bursting} min. [bar]	U _b DC [V]	Draw- ing no.	Order no.
------	--------------------	---------	--------------------------	-------------------------------------	-------------------------------------	-----------------------------	---------------------	--------------

M12 connector · Output function 1 x normally open / normally closed programmable + 1 x normally open / normally closed programmable or 1 x analogue (4...20 / 20...4 mA, scalable) · Wiring diagram no. 16 · Connector groups 8, 10, 18, 20, 120, 124, 126, 128, 157

	Aseptoflex Vario	Display unit	-1...1	10	30	20...32	23	PI2799
	Aseptoflex Vario	Display unit	-0.05...1	10	30	20...32	23	PI2797
	Aseptoflex Vario	Display unit	-0.124...2.5	20	50	20...32	23	PI2796
	Sealing cone G1 male	Display unit	-0.005...0.1	4	30	20...32	24	PI2889*
	Sealing cone G1 male	Display unit	-0.124...2.5	20	50	20...32	24	PI2896*
	Sealing cone G1 male	Display unit	-0.05...1	10	30	20...32	24	PI2897*
	Sealing cone G1 male	Display unit	-0.0124...0.25	10	30	20...32	24	PI2898*
	Sealing cone G1 male	Display unit	-1...1	10	30	20...32	24	PI2899*
	Clamp DN 38 / 1 1/2"	Display unit	-0.124...2.5	20	50	20...32	25	PI2206
	Clamp DN 38 / 1 1/2"	Display unit	-0.05...1	10	30	20...32	25	PI2207
	Clamp DN 38 / 1 1/2"	Display unit	-1...1	10	30	20...32	25	PI2209

M12 connector · Output function 1 x normally open / closed programmable + 1 x analogue (4...20 / 20...4 mA, scalable) · Wiring diagram no. 17 · Connector groups 8, 10, 18, 20, 120, 124, 126, 128, 157









	Aseptoflex Vario	Display unit	-0.005...0.1	4	30	18...32	26	PG2789
	Aseptoflex Vario	Display unit	-0.0124...0.25	10	30	18...32	26	PG2798
	Aseptoflex Vario	Display unit	-0.05...1	10	30	18...32	26	PG2797
	Aseptoflex Vario	Display unit	-1...1	10	30	18...32	26	PG2799
	Aseptoflex Vario	Display unit	-0.124...2.5	20	50	18...32	26	PG2796









Process sensors

Type	Process connection	Display	Measuring range [bar]	P _{overload} max. [bar]	P _{bursting} min. [bar]	U _b DC [V]	Draw- ing no.	Order no.
M12 connector · Output function 1 x normally open / closed programmable + 1 x analogue (4...20 / 20...4 mA, scalable) · Wiring diagram no. 17 · Connector groups 8, 10, 18, 20, 120, 124, 126, 128, 157								
	Sealing cone G1 male	Display unit	-0.124...2.5	20	50	18...32	27	PG2896*
	Sealing cone G1 male	Display unit	-0.05...1	10	30	18...32	27	PG2897*
	Sealing cone G1 male	Display unit	-0.0124...0.25	10	30	18...32	27	PG2898*
	Sealing cone G1 male	Display unit	-1...1	10	30	18...32	27	PG2899*
	Sealing cone G1 male	Display unit	-0.005...0.1	4	30	18...32	27	PG2889*



* Attention: The unit must only be installed in a process connection for G1 sealing cone! The G1 male sealing cone of the unit is only suited for adapters with metal end stop!

Accessories for level sensors LK, LT, LL, LI



Type	Description	Order no.
	Flange plate · 54-52X52 D16 · for capacitive level sensors LK, LI, LT, LL · Housing materials: flange: aluminium anodised / nut: stainless steel / Spacer: Brass / rubber ring: FPM / sealing: Tesnit	E43007
	Flange plate · 65-80 D16 · for capacitive level sensors LK, LI, LT, LL · Housing materials: flange: aluminium anodised / nut: stainless steel / Spacer: Brass / rubber ring: FPM	E43006
	Flange plate · 73-90 D16 · for capacitive level sensors LK, LI, LT, LL · according to DIN 24557 · Housing materials: aluminium anodised / nut: stainless steel / Spacer: Brass / rubber ring: FPM / sealing: NBR	E43001
	Mounting adapter · G 3/4 D16 · D16 · for capacitive level sensors LK, LI, LT, LL · Housing materials: flange: stainless steel / nut: stainless steel / Spacer: Brass / rubber ring: FPM / sealing: Tesnit	E43003
	Mounting adapter · G 3/4 D16 · D16 · for capacitive level sensors LI · Housing materials: Brass nickel-plated / TPE / sealing: FKM	E43019
	Mounting adapter · G 3/4 D22 · D22 · for climatic tube LK / LI · Housing materials: stainless steel / NBR / Tesnit / Brass	E43008
	Mounting adapter · 3/4" NPT D16 · D16 · for capacitive level sensors LK, LI, LT, LL · Housing materials: flange: stainless steel / nut: stainless steel / Spacer: Brass / rubber ring: FPM	E43012
	Mounting adapter · 3/4" NPT D22 · D22 · for climatic tube LK / LI · Housing materials: stainless steel / NBR / Brass	E43014

Type	Description	Order no.
	Mounting adapter · G 1 D16 · D16 · for capacitive level sensors LK, LI, LT, LL · Housing materials: flange: stainless steel / nut: stainless steel / Spacer: Brass / rubber ring: FPM / sealing: Tesnit	E43004
	Mounting adapter · G 1 D22 · D22 · for climatic tube LK / LI · Housing materials: stainless steel / NBR / Tesnit / Brass	E43009
	Mounting adapter · 1" NPT D16 · D16 · for capacitive level sensors LK, LI, LT, LL · Housing materials: flange: stainless steel / nut: stainless steel / Spacer: Brass / rubber ring: FPM	E43013
	Climatic tube · Length: 132 mm · for capacitive level sensors LK, LI · Housing materials: PPH / NBR	E43103
	Climatic tube · Length: 264 mm · for capacitive level sensors LK, LI · Housing materials: PPH / NBR	E43100
	Climatic tube · Length: 472 mm · for capacitive level sensors LK, LI · Housing materials: PPH / NBR	E43101
	Climatic tube · Length: 728 mm · for capacitive level sensors LK, LI · Housing materials: PPH / NBR	E43102
	Mounting clamp · Ø 16 mm · for capacitive level sensors LK, LI, LT, LL · Housing materials: PP	E43000
	Mounting set · Ø 16 mm · for capacitive level sensors LK, LI, LT, LL · Housing materials: PP / Metal parts: steel galvanised	E43016
	Welding adapter · Ø 50 D16 · D16 · for capacitive level sensors LK, LI, LT, LL · Housing materials: flange: stainless steel / nut: stainless steel / Spacer: Brass / rubber ring: FPM	E43002
	Protective cover · for LK / LL / LR / LT sensors · Housing materials: PP	E43910

Parameter-setting system

Type	Description	Order no.
	IO-Link interface · for parameter setting and analysis of units with max. 65 mA current consumption · Supported communication protocols: IO-Link (4800 and 38400 bits/s) EPS protocol (19200 bits/s) · for operation with FDT framework software "ifm Container" or software "LINERECORDER SENSOR"	E30396
	ifm Container · FDT frame software · for parameter setting and analysis of units with DTM specification · e.g. ifm sensors with EPS programming interface, · sensors with IO-Link	E30110







Process sensors







Type	Description	Order no.
	LINERECORDER SENSOR · Version 4.0.0 · Software for clear online and offline parameter setting of IO-Link sensors via USB adapter · Use via USB connection cable (drivers are supplied): E30396 IO-Link interface or E30390 IO-Link master (note the respective data sheet) · IODD import and update from ifm's homepage · Reading of IODDs via storage media · Automatic sensor identification · Graphic representation of the process values and history incl. export function · Documentation and archiving · Transferable parameter sets · Full memory plug support for IO-Link 1.1	QA0001
	Memory plug · Parameter memory for IO-Link sensors · Storage capacity: 2 Kbytes · Housing materials: PA PACM 12 / PET / sealing: FPM / nut: stainless steel 316L / 1.4404 / connector: TPU	E30398
	USB IO-Link master · for parameter setting and analysis of units · Supported communication protocols: IO-Link (4.8, 38.4 and 230 Kbits/s) · for operation with FDT framework software "ifm Container" or software "LINERECORDER SENSOR"	E30390

Certificates







Description	Order no.
Factory calibration certificate for pressure sensors and flow sensors · Measurement points, pressure sensors: 6 measurement points in 20% steps of the final value of the measuring range (acc. to ISO 9001) · Measurement points, flow sensors: 3 or 4 measurement points, distances defined depending on the measuring range (acc. to ISO 9001)	ZC0004
DAkKS calibration certificate for pressure sensors · Number of measuring points: 11-point DAkKS calibration · Measurement points: in 10 % steps of the measuring range (according to directive DAkKS-DKD-R 6-1) · Minimum measurement uncertainty [bar]: 20 µbar...140 mbar (depending on the reference pressure)	ZC0005

Accessories for level sensors LM

Type	Description	Order no.
	Clamp adapter · Clamp · 1-1.5" · ISO 2852 / DIN 32676 · for units with G ½ adaptation · Housing materials: stainless steel 316L / 1.4404	E33401
	Clamp adapter · Clamp · 2" · ISO 2852 / DIN 32676 · for units with G ½ adaptation · Housing materials: stainless steel 316L / 1.4404	E33402
	Welding adapter · G ½ - Ø 35 mm · Housing materials: stainless steel 316L / 1.4404	E30055
	Welding adapter · G ½ - Ø 45 mm · Housing materials: stainless steel 316L / 1.4404	E30056
	Welding adapter · G ½ - Ø 30 mm · for tanks · Housing materials: stainless steel 316L / 1.4435	E43300
	Welding adapter · G ½ - Ø 29 mm · for pipes · Housing materials: stainless steel 316L / 1.4435	E43301
	Adapter · G ¾ · Housing materials: stainless steel 316L / 1.4435	E43302



Type	Description	Order no.
	Adapter · G 1 · Housing materials: stainless steel 316L / 1.4435	E43303
	Adapter · 3/4" NPT · Housing materials: stainless steel 316L / 1.4404	E43313
	Pipe fitting · G 1/2 · Hygienic pipe fitting · DN25 (1") · DIN 11851 · Housing materials: stainless steel 316L / 1.4435	E43304
	Pipe fitting · G 1/2 · Hygienic pipe fitting · DN40 (1.5") · DIN 11851 · Housing materials: stainless steel 316L / 1.4435	E43305
	Clamp adapter · G 1/2 · Varivent type F · DN25 (1"), D = 50 · Housing materials: stainless steel 316L / 1.4435	E43306
	Clamp adapter · G 1/2 · Varivent type N · DN40...DN150 (1.5...6"), D = 68 · Housing materials: stainless steel 316L / 1.4435	E43307
	Welding mandrel · G 1/2 · carries away heat during welding · Housing materials: brass	E43314

Accessories 3A

Type	Description	Order no.
	Pipe fitting · SMS pipe fitting · DN25 · SMS · for units with G 1/2 adaptation · Housing materials: stainless steel 316L / 1.4404	E33430
	sealing plug · G 1/2 · Housing materials: stainless steel 316L / 1.4435	E43308
	Welding adapter · G 1/2 - Ø 30 mm · for tanks · with leakage port · with leakage port · Housing materials: stainless steel 316L / 1.4435	E43309
	Welding adapter · G 1/2 - Ø 29 mm · for pipes · with leakage port · with leakage port · Housing materials: stainless steel 316L / 1.4435	E43310
	Welding adapter · G 1/2 · with leakage port · Housing materials: stainless steel 316L / 1.4404	E43315
	Clamp adapter · G 1/2 · with leakage port · Clamp · 1-1.5" · ISO 2852 / DIN 32676 · with leakage port · Housing materials: stainless steel 316L / 1.4435	E43311

Type	Description	Order no.
	Clamp adapter · G ½ · with leakage port · Clamp · 2" · ISO 2852 / DIN 32676 · with leakage port · Housing materials: stainless steel 316L / 1.4435	E43312

Accessories for level sensors LR

Type	Description	Order no.
	Flange plate · 65-80 / G ¾ · for level sensors LR · Housing materials: flange: stainless steel	E43202
	Flange plate · 73-90 / G ¾ · for level sensors LR · according to DIN 24557 · Housing materials: flange: stainless steel / sealing: NBR	E43201
	Flange plate · 73-90 / ¾" NPT · for level sensors LR · according to DIN 24557 · Housing materials: flange: stainless steel / sealing: NBR	E43206

LR probes for standard applications



Type	Description	Order no.
	Probe · Probe length: 150 mm · for level sensors LR · Housing materials: stainless steel 316L / 1.4404	E43225
	Probe · Probe length: 210 mm · for level sensors LR · Housing materials: stainless steel	E43351
	Probe · Probe length: 240 mm · for level sensors LR · Housing materials: stainless steel 316L / 1.4404	E43203
	Probe · Probe length: 265 mm · for level sensors LR · Housing materials: stainless steel	E43352
	Probe · Probe length: 300 mm · for level sensors LR · Housing materials: stainless steel 316L / 1.4404	E43226
	Probe · Probe length: 450 mm · for level sensors LR · Housing materials: stainless steel 316L / 1.4404	E43204
	Probe · Probe length: 500 mm · for level sensors LR · Housing materials: stainless steel 316L / 1.4404	E43227
	Probe · Probe length: 700 mm · for level sensors LR · Housing materials: stainless steel 316L / 1.4404	E43205



Type	Description	Order no.
	Probe · Probe length: 1000 mm · for level sensors LR · Housing materials: stainless steel 316L / 1.4404	E43207
	Probe · Probe length: 1200 mm · for level sensors LR · Housing materials: stainless steel 316L / 1.4404	E43208
	Probe · Probe length: 1400 mm · for level sensors LR · Housing materials: stainless steel 316L / 1.4404	E43209
	Probe · Probe length: 1600 mm · for level sensors LR · Housing materials: stainless steel 316L / 1.4404	E43210
	Probe · Probe length: 2000 mm · for level sensors LR205X · Housing materials: stainless steel	E43353

LR probes for hygienic areas





Type	Description	Order no.
	Probe · Probe length: 150 mm · hygienic, for LR level sensors · hygienic systems · Housing materials: stainless steel	E43345
	Probe · Probe length: 300 mm · hygienic, for LR level sensors · hygienic systems · Housing materials: stainless steel	E43346
	Probe · Probe length: 500 mm · hygienic, for LR level sensors · hygienic systems · Housing materials: stainless steel	E43340
	Probe · Probe length: 700 mm · hygienic, for LR level sensors · hygienic systems · Housing materials: stainless steel	E43347
	Probe · Probe length: 1000 mm · hygienic, for LR level sensors · hygienic systems · Housing materials: stainless steel	E43341
	Probe · Probe length: 1500 mm · hygienic, for LR level sensors · hygienic systems · Housing materials: stainless steel	E43348
	Probe · Probe length: 2000 mm · hygienic, for LR level sensors · hygienic systems · Housing materials: stainless steel	E43342

LR coaxial pipes



Type	Description	Order no.
	Coaxial pipe · Length: 150 mm · G 3/4 · for level sensors LR · Housing materials: stainless steel / sealing: Tesnit	E43230
	Coaxial pipe · Length: 210 mm · G 3/4 · for level sensors LR · Housing materials: Coaxial pipe: 304 / 1.4301 / fixing bracket: 301 / 1.4310 / centring piece: PP GF30 / Seal: aramid 20 / NBR80:	E43354
	Coaxial pipe · Length: 240 mm · G 3/4 · for level sensors LR · Housing materials: stainless steel / sealing: Tesnit / centring piece: PP / fixing bracket: stainless steel	E43211
	Coaxial pipe · Length: 265 mm · G 3/4 · for level sensors LR · Housing materials: Coaxial pipe: 304 / 1.4301 / fixing bracket: 301 / 1.4310 / centring piece: PP GF30 / Seal: aramid 20 / NBR80:	E43355
	Coaxial pipe · Length: 300 mm · G 3/4 · for level sensors LR · Housing materials: stainless steel / sealing: Tesnit / centring piece: PP / fixing bracket: stainless steel	E43228
	Coaxial pipe · Length: 450 mm · G 3/4 · for level sensors LR · Housing materials: stainless steel / sealing: Tesnit / centring piece: PP / fixing bracket: stainless steel	E43212
	Coaxial pipe · Length: 500 mm · G 3/4 · for level sensors LR · Housing materials: stainless steel / sealing: Tesnit / centring piece: PP / fixing bracket: stainless steel	E43229
	Coaxial pipe · Length: 700 mm · G 3/4 · for level sensors LR · Housing materials: stainless steel / sealing: Tesnit / centring piece: PP / fixing bracket: stainless steel	E43213
	Coaxial pipe · Length: 1000 mm · G 3/4 · for level sensors LR · Housing materials: stainless steel / sealing: Tesnit / centring piece: PP / fixing bracket: stainless steel	E43214
	Coaxial pipe · Length: 1200 mm · G 3/4 · for level sensors LR · Housing materials: stainless steel / sealing: Tesnit / centring piece: PP / fixing bracket: stainless steel	E43215
	Coaxial pipe · Length: 1400 mm · G 3/4 · for level sensors LR · Housing materials: stainless steel / sealing: Tesnit / centring piece: PP / fixing bracket: stainless steel	E43216
	Coaxial pipe · Length: 1600 mm · G 3/4 · for level sensors LR · Housing materials: stainless steel / sealing: Tesnit / centring piece: PP / fixing bracket: stainless steel	E43217
	Coaxial pipe · Length: 2000 mm · G 3/4 · for level sensors LR205X · Housing materials: Coaxial pipe: 304 / 1.4301 / fixing bracket: 301 / 1.4310 / centring piece: PP GF30 / Seal: aramid 20 / NBR80:	E43356
	Coaxial pipe · Length: 450 mm · 3/4" NPT · for level sensors LR · Housing materials: stainless steel / centring piece: PP / fixing bracket: stainless steel	E43218
	Coaxial pipe · Length: 700 mm · 3/4" NPT · for level sensors LR · Housing materials: stainless steel / centring piece: PP / fixing bracket: stainless steel	E43219





Type	Description	Order no.
	Coaxial pipe · Length: 1000 mm · 3/4" NPT · for level sensors LR · Housing materials: stainless steel / centring piece: PP / fixing bracket: stainless steel	E43220
	Coaxial pipe · Length: 1200 mm · 3/4" NPT · for level sensors LR · Housing materials: stainless steel / centring piece: PP / fixing bracket: stainless steel	E43223
	Coaxial pipe · Length: 1400 mm · 3/4" NPT · for level sensors LR · Housing materials: stainless steel / centring piece: PP / fixing bracket: stainless steel	E43224
	Coaxial pipe · Length: 1600 mm · 3/4" NPT · for level sensors LR · Housing materials: stainless steel / centring piece: PP / fixing bracket: stainless steel	E43221
	Coaxial pipe · Length: 700 mm · G 3/4 · for level sensors LR · Housing materials: stainless steel / sealing: Tesnit / centring piece: PP / fixing bracket: stainless steel	E43333
	Coaxial pipe · Length: 1200 mm · G 3/4 · for level sensors LR · Housing materials: stainless steel / sealing: Tesnit / centring piece: PP / fixing bracket: stainless steel	E43334

Accessories for level sensors PA, PG, PI, PN, PS, PY

Type	Description	Order no.
	Cable clamp fastener · for submersible pressure transmitter PS3 · Housing materials: steel / plastics	E30399
	Filter element · for submersible pressure transmitter PS3 · for fixing on the capillary tube	E30400
	Splitter box · with ventilation and terminal block · for submersible pressure transmitter PS3 · Housing materials: plastics	E30401
	Additional weight · for submersible pressure transmitter PS3 · Housing materials: stainless steel 316Ti / 1.4571	E30402

Hygienic adapters

Type	Description	Order no.
	Welding adapter · Ø 50 mm · for units with Aseptoflex Vario adapter · Sealing by sealing ring · Housing materials: stainless steel 316L / 1.4435	E30122
	Pipe fitting · Hygienic pipe fitting · Hygienic pipe fitting · DN40 (1.5") · DIN 11851 · for units with Aseptoflex Vario adapter · Sealing by sealing ring · Housing materials: stainless steel 316L / 1.4435	E33212

Type	Description	Order no.
	Pipe fitting · Hygienic pipe fitting · Hygienic pipe fitting · DN50 (2") · DIN 11851 · for units with Aseptoflex Vario adapter · Sealing by sealing ring · Housing materials: stainless steel 316L / 1.4435	E33213
	Pipe fitting · Hygienic pipe fitting · Hygienic pipe fitting · DN40 (1.5") · DIN 11851 · for units with Aseptoflex Vario adapter · Metal to metal seal · Housing materials: stainless steel 316L / 1.4435	E33712
	Pipe fitting · Hygienic pipe fitting · Hygienic pipe fitting · DN50 (2") · DIN 11851 · for units with Aseptoflex Vario adapter · Metal to metal seal · Housing materials: stainless steel 316L / 1.4435	E33713
	Clamp adapter · Clamp · 1-1.5" · ISO 2852 · for units with Aseptoflex Vario adapter · Sealing by sealing ring · Housing materials: stainless steel 316L / 1.4435	E33201
	Clamp adapter · Clamp · 1-1.5" · ISO 2852 · for units with Aseptoflex Vario adapter · Metal to metal seal · Housing materials: stainless steel 316L / 1.4435	E33701

Wiring diagrams

Core colours

- BK black
- BN brown
- BU blue
- WH white
- GY grey
- GN green

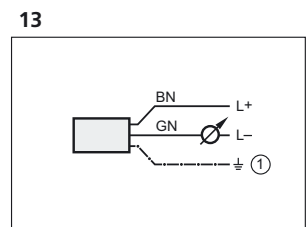
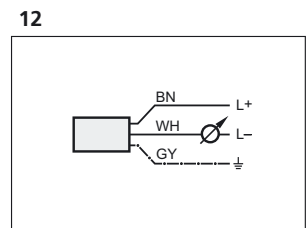
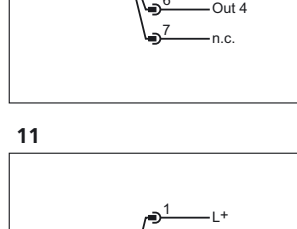
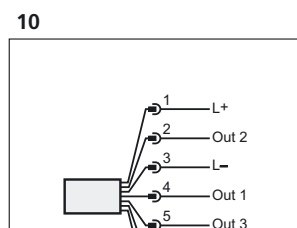
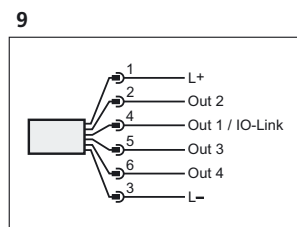
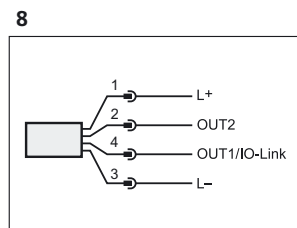
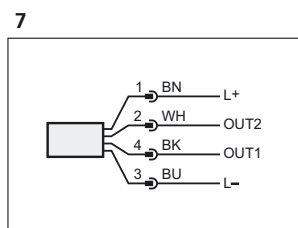
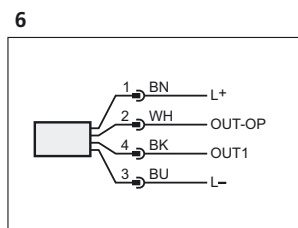
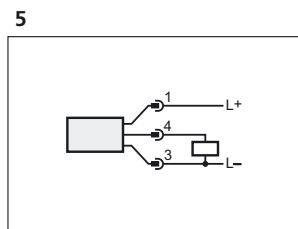
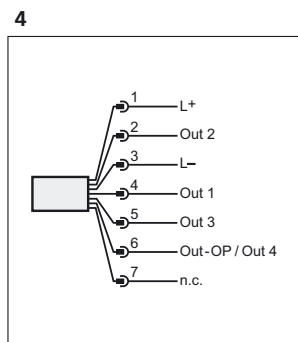
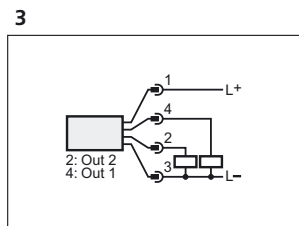
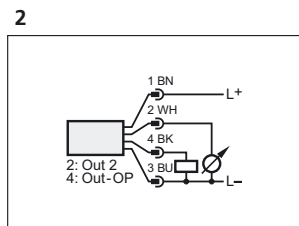
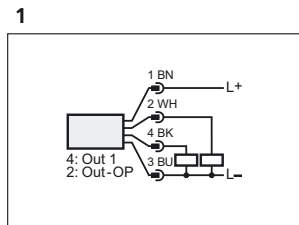

1: screen (connected to the housing)

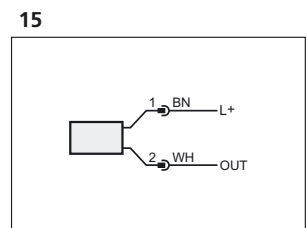
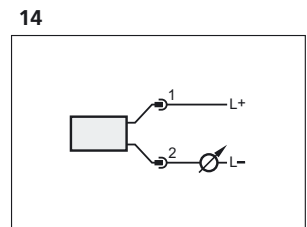

Wiring diagrams

16

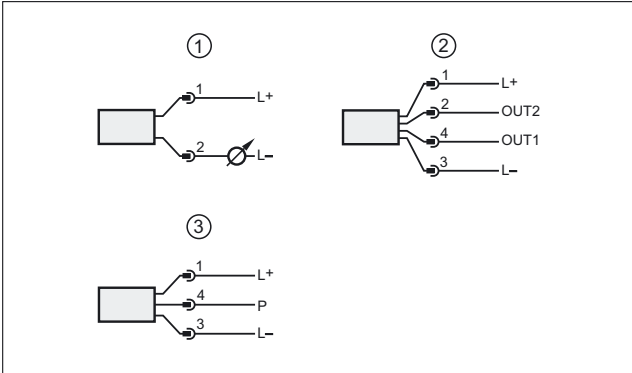

1: connection for 2-wire operation, 2: connection for 3-wire operation, 3: connection for IO-Link parameter setting (P = communication via IO-Link)

17

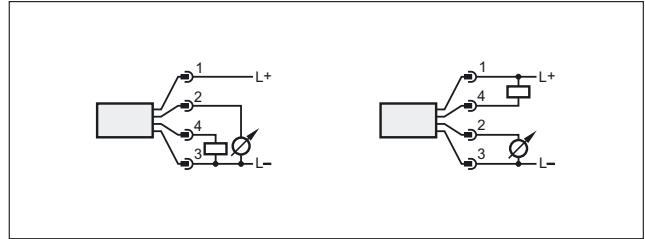

Scale drawings / drawing no. – CAD download: www.ifm.com

1

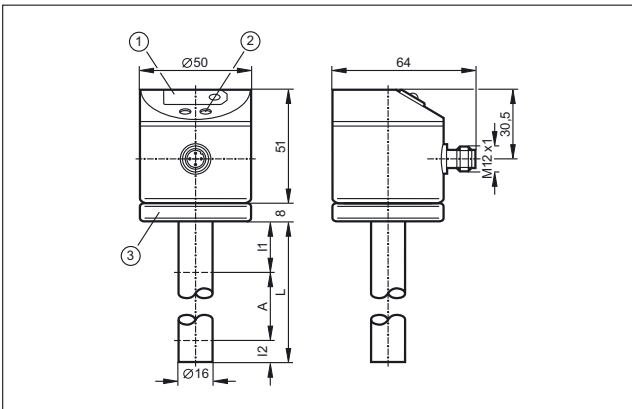

1: 7-segment LED display, 2: Programming buttons, 3: Housing connection with cable lug for cable 1.5 - 2.5 mm²

3

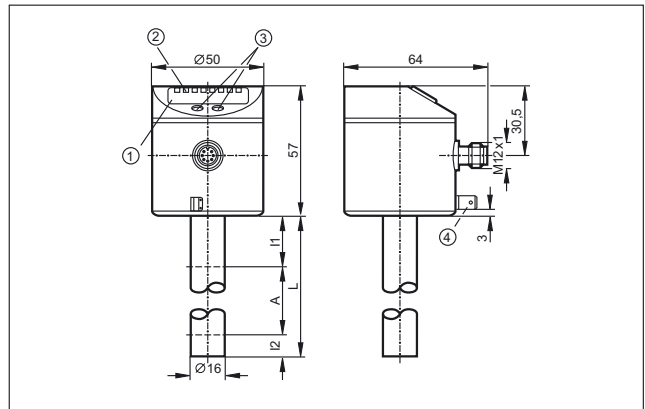

1: 4-digit alphanumeric display, 2: LEDs, 3: Programming buttons, 4: Housing connection (flat-pin connector 6.3 mm following DIN 46244)

2

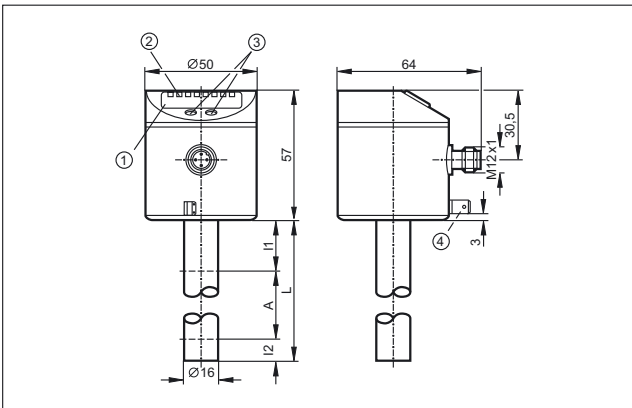

1: 4-digit alphanumeric display, 2: LEDs, 3: Programming buttons, 4: Housing connection (flat-pin connector 6.3 mm following DIN 46244)

4

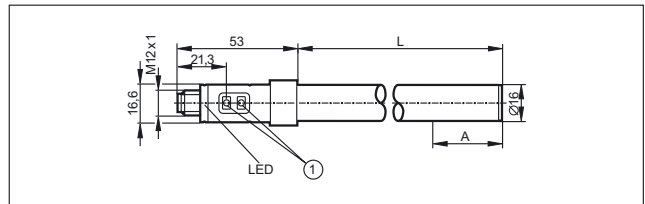

1: Programming buttons

5

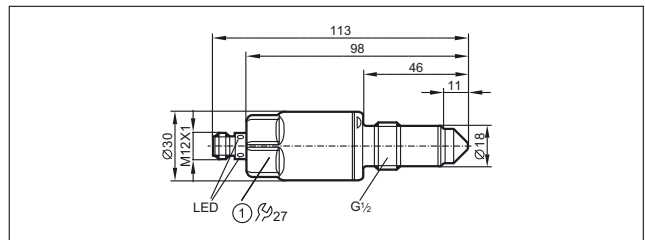

1: tightening torque 20...25 Nm

Scale drawings / drawing no. – CAD download: www.ifm.com

6

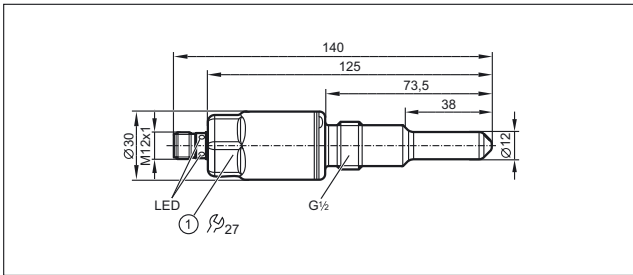

1: tightening torque 20...25 Nm

7

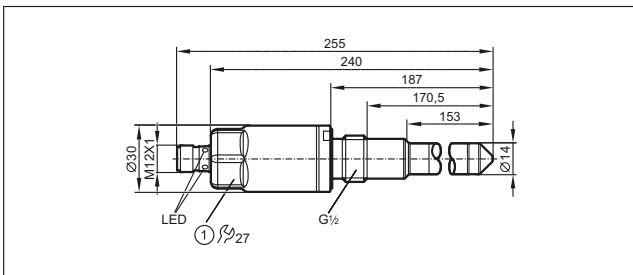

1: tightening torque 20...25 Nm

8

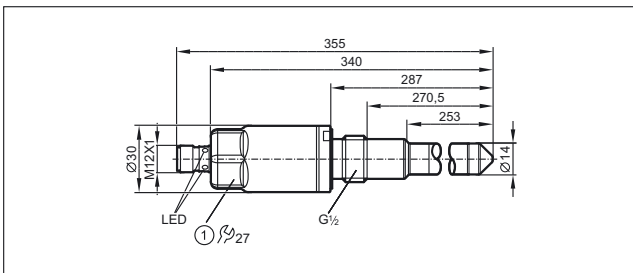

1: tightening torque 20...25 Nm

9

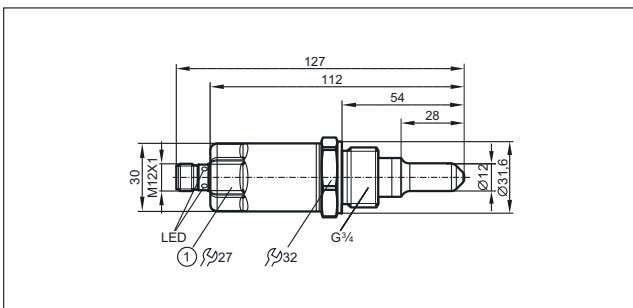

1: tightening torque 35 Nm

10

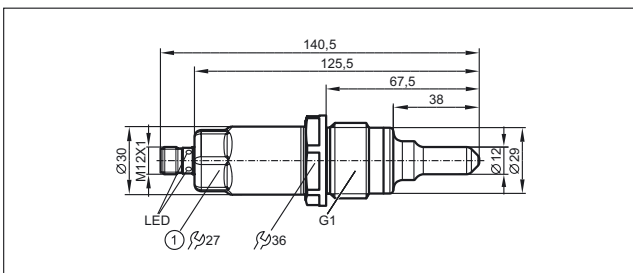

1: tightening torque 35 Nm

11

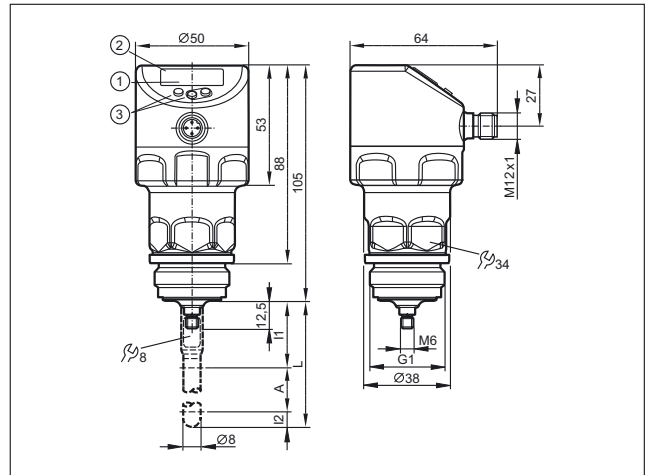

12

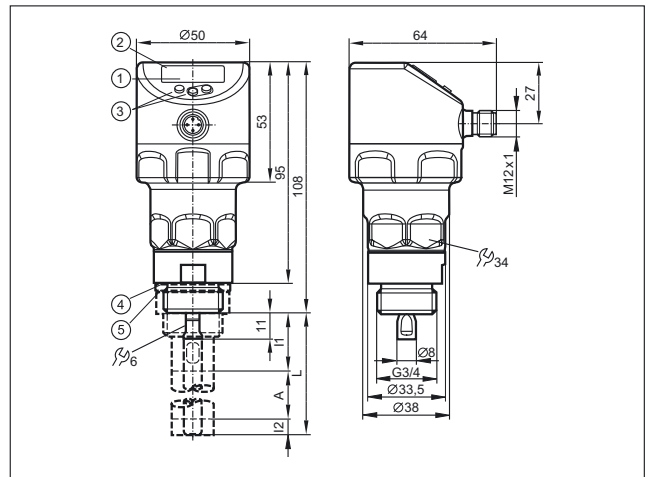

13

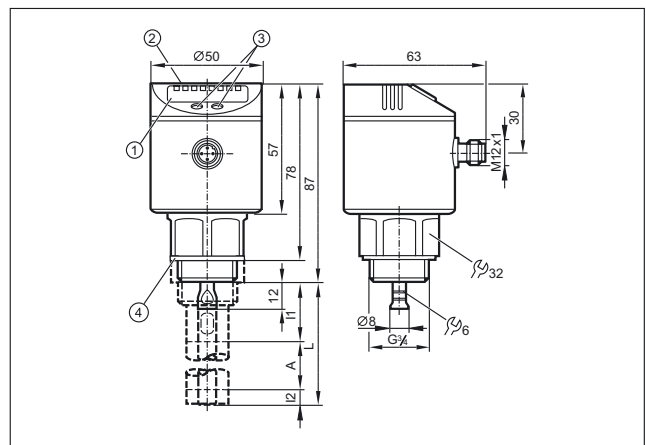

1: 4-digit alphanumeric display, 2: LEDs (display unit / switching status), 3: Programming buttons, 4: sealing, A: Active range, I1 / I2: Inactive ranges

Scale drawings / drawing no. – CAD download: www.ifm.com

14

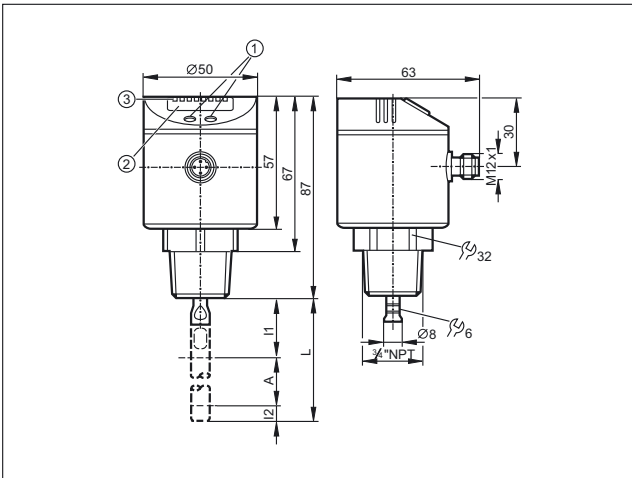

1: 4-digit alphanumeric display, 2: LEDs (display unit / switching status), 3: Programming buttons, A: Active range, I1 / I2: Inactive ranges

15

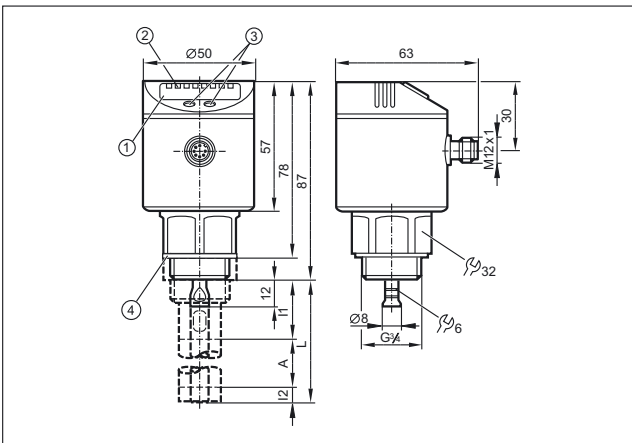

1: 4-digit alphanumeric display, 2: LEDs (display unit / switching status), 3: Programming buttons, 4: sealing, A: Active range, I1 / I2: Inactive ranges

16

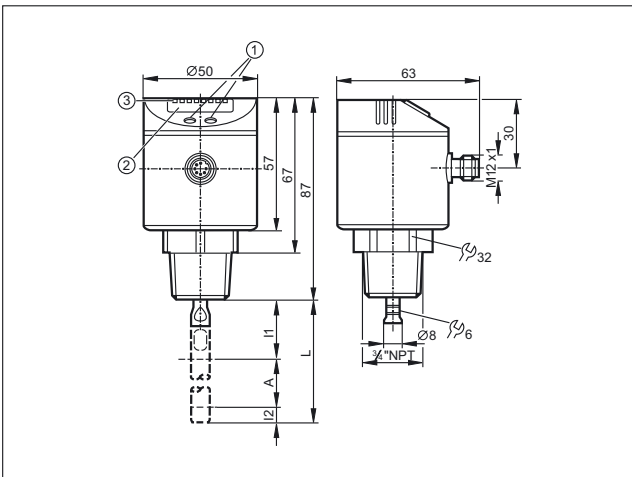

17

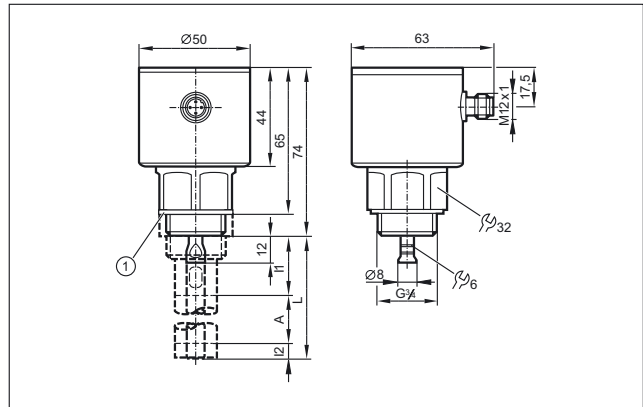

18

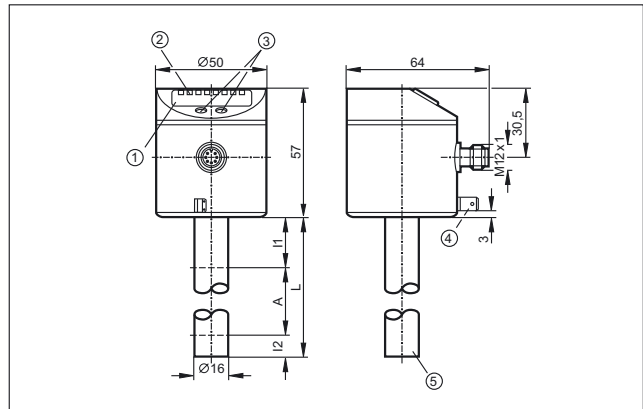

1: 4-digit alphanumeric display, 2: LEDs, 3: Programming buttons, 4: Housing connection (flat-pin connector 6.3 mm following DIN 46244), 5: Position of the temperature measuring element

19

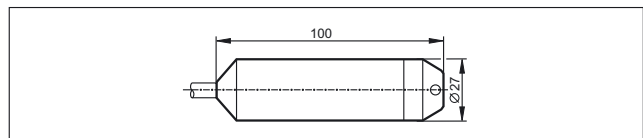

20

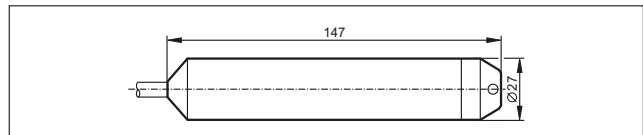

21

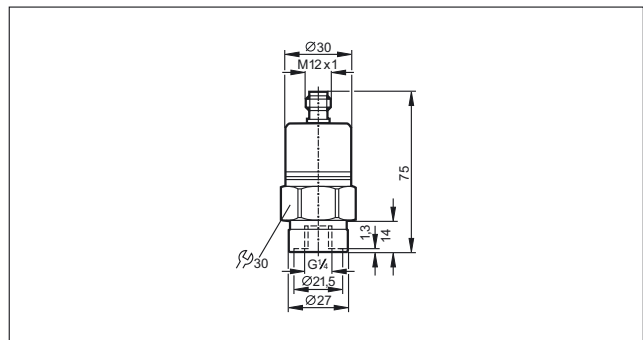

Scale drawings / drawing no. – CAD download: www.ifm.com

22

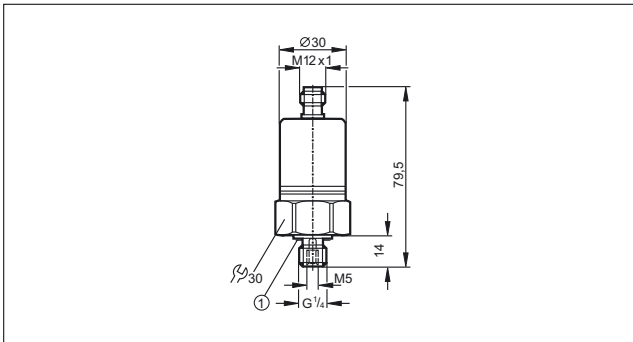

1: sealing FPM / DIN 3869-14

23

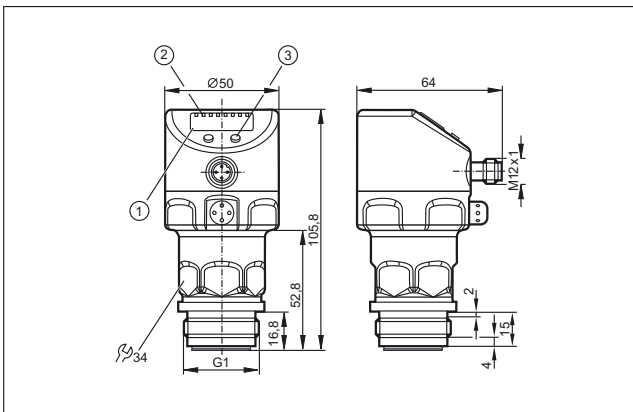

1: 4-digit alphanumeric display, 2: LEDs, 3: Programming button

24

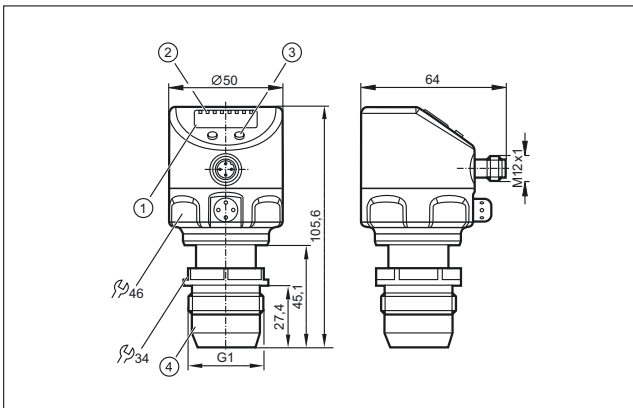

1: 4-digit alphanumeric display, 2: LEDs, 3: Programming button, 4: Sealing cone G1 male, Attention: The unit must only be installed in a process connection for G1 sealing cone! The G1 male sealing cone of the unit is only suited for adapters with metal end stop!

25

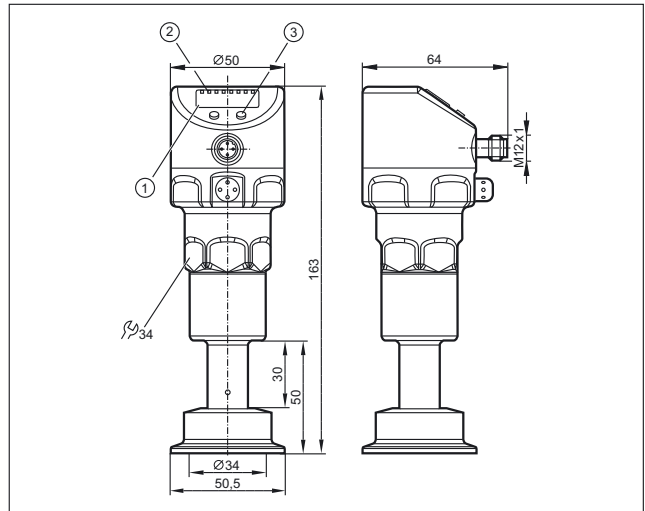

1: 4-digit alphanumeric display, 2: LEDs, 3: Programming button

26

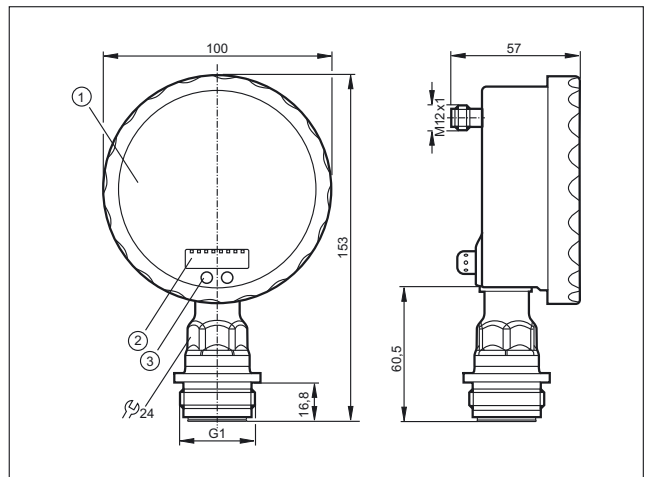

1: Analogue display, 2: 4-digit alphanumeric display, 3: Programming button

27

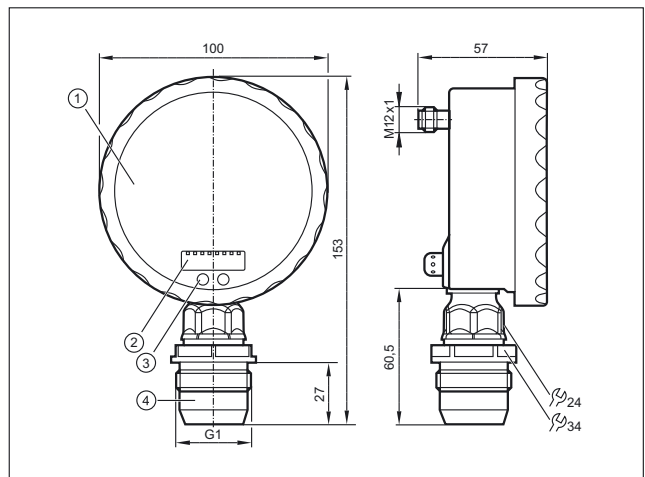

1: Analogue display, 2: 4-digit alphanumeric display, 3: Touch button (programming button), 4: Sealing cone G1 male, Attention: The unit must only be installed in a process connection for G1 sealing cone! The G1 male sealing cone of the unit is only suited for adapters with metal end stop!





- Temperature sensors in contact with the medium for industrial and hygienic applications
- Modular concept – tailored to every application
- Various fittings available for process connections
- Robust mechanics with high vibration and shock resistance
- Non-contact infrared temperature sensors for hot objects

Temperature sensors

ifm offers a very wide range of temperature monitoring products to suit the needs of many industries. One end of the range offers simple probes based on Pt100 or Pt1000 resistive elements. At the top end we have a diverse redundant transmitter design which is warranted to stay within tolerance for 5 years or raise an alarm if it drifts – ideal for those critical or difficult to reach installations.

What makes an ifm probe different?

The key to a good temperature probe is the balance between being responsive to changing temperatures and being robust enough to cope with an ever changing environment. ifm uses flexible, temperature-resistant and extremely stable polyamide film as a carrier of the SMD Pt100 components in place of circuit boards. This allows us to position the sensing element right up to the probe wall, making for a very fast response.

From sensor to system

ifm provides a selection of options for customers requiring temperature monitoring. The simplest systems are the all-in-one temperature transmitters which can be supplied for both industrial and hygienic applications. Others prefer the flexibility of sourcing the probe and monitor separately and then combining them on site in one of several ways. This gives the widest range of probe shapes and sizes for specific applications. The evaluation can be achieved locally with a simple head transmitter, type TP, or by using a more feature-laden monitor like the TR which has its own display. The top end solution is the TAD transmitter. It uses two independent temperature monitoring technologies which are then internally cross-checked by the microprocessor. If ever they stop agreeing with each other's measurement then the transmitter will raise an alarm to alert the customer that he can no longer be 100 % certain of that measure and some action should be taken. ifm offers a 5 year warranty on that peace of mind.

Indirect temperature measurement

In most cases the infrared temperature measurement is used where temperatures can only be measured indirectly, that means without contact. The reason for this can for example be a high temperature of the object. The sensors detect the infrared radiation emitted by the objects and convert them into an output signal.



Local display of the current temperature.

Essential: Temperature monitoring in air conditioning.



System overview	Page
Compact temperature sensors	532
Compact temperature sensors with display, IO-Link	532
Control monitors for temperature sensors	532
Control monitors for temperature sensors, IO-Link	533
Modular temperature transmitters	533
Pt1000 probe sensors for industrial applications	533 - 534
Pt100 probe sensors for industrial applications	534 - 535
Screw-in sensors for industrial applications	535
Cable sensors for industrial applications	535 - 536
Cable sensors with bolt-on sensor for industrial applications	537
Screw-in sensor with ATEX approval 3D/3G	537
Cable sensors for ATEX applications 3D/3G	537
Cable sensors with bolt-on sensors for ATEX 3D / 3G applications	537
IO-Link temperature transmitters	538 - 539
Probe sensors for hygienic and wet areas	539
Sensors with process connection for hygienic and wet areas	539 - 540
Temperature transmitters for hygienic and wet areas	540 - 541
Self-monitoring temperature transmitters for hygienic and wet areas, IO-Link	542
Temperature transmitter with display for hygienic and wet areas, IO-Link	542 - 545
Infrared temperature sensors	545 - 546
Accessories for temperature sensors TN / TR	546
Accessories for infrared temperature sensors	546 - 547
Accessories and software	547
Certificates	547 - 548
Thermowells for temperature sensors	548 - 550
Adapters	550 - 552
Hygienic adapters	552 - 556
Wiring diagrams	556 - 557
Scale drawings / drawing no. – CAD download: www.ifm.com	557 - 562

Compact temperature sensors

Type	Measuring range [°C / °F]	Process connection	Installation length [mm]	U _b [V]	Dynamic response T05 / T09 [s]	Drawing no.	Order no.
------	------------------------------	--------------------	-----------------------------	-----------------------	--------------------------------------	-------------	-----------

M12 connector · Output function · DC PNP · Wiring diagram no. 1 · Connector groups 8, 9, 10, 11, 18, 20, 120, 124, 126, 128, 130, 131, 157, 158

	-25...140 / -13...284	G ¼ A	39	9.6...32	1 / 3	1	TK6130
--	-----------------------	-------	----	----------	-------	---	--------

M12 connector · Output function · DC PNP · Wiring diagram no. 2 · Connector groups 8, 9, 10, 11, 18, 20, 120, 124, 126, 128, 130, 131, 157, 158

	-25...140 / -13...284	G ¼ A	39	9.6...32	1 / 3	1	TK7130
--	-----------------------	-------	----	----------	-------	---	--------

M12 connector · Output function 1 x normally open / 1 x normally closed · DC PNP · Wiring diagram no. 2 · Connector groups 8, 9, 10, 11, 18, 20, 120, 124, 126, 128, 130, 131, 157, 158

	-25...140 / -13...284	G ½ A	267	9.6...32	1 / 3	2	TK7480
--	-----------------------	-------	-----	----------	-------	---	--------

Compact temperature sensors with display, IO-Link

Type	Measuring range [°C / °F]	Process connection	Installation length [mm]	U _b [V]	Dynamic response T05 / T09 [s]	Drawing no.	Order no.
------	------------------------------	--------------------	-----------------------------	-----------------------	--------------------------------------	-------------	-----------

M12 connector · Output function 1 x normally open / closed programmable + 1 x analogue (4...20 mA / 0...10 V, scalable) · DC PNP/NPN · Wiring diagram no. 3 · Connector groups 8, 10, 18, 20, 120, 124, 126, 128, 157

	-50...150 / -58...302	M18 x 1.5	45	18...32	1 / 3 **	3	TN2511
--	-----------------------	-----------	----	---------	----------	---	--------

M12 connector · Output function 2 x normally open / closed programmable · DC PNP/NPN · Wiring diagram no. 3 · Connector groups 8, 10, 18, 20, 120, 124, 126, 128, 157

	-50...150 / -58...302	M18 x 1.5	45	18...32	1 / 3	3	TN7511
--	-----------------------	-----------	----	---------	-------	---	--------

Control monitors for temperature sensors

Type	Measuring range [°C]	Process connection	Display	U _b [V]	Current consumption [mA]	I _{load} [mA]	Drawing no.	Order no.
------	-------------------------	--------------------	---------	-----------------------	-----------------------------	---------------------------	-------------	-----------

M12 connector · Output function 4 x normally open / closed programmable · DC PNP · Wiring diagram no. 6 · Connector groups 16, 17

	-40...150	G ½ A	Display unit	18...28	90	500	4	TR8430
--	-----------	-------	--------------	---------	----	-----	---	--------

Control monitors for temperature sensors, IO-Link

Type	Measuring range [°C]	Process connection	Display	U _b [V]	Current consumption [mA]	I _{load} [mA]	Drawing no.	Order no.
------	-------------------------	--------------------	---------	-----------------------	-----------------------------	---------------------------	-------------	-----------

M12 connector · Output function 1 x normally open / closed programmable + 1 x analogue (4...20 mA / 0...10 V, scalable) · DC PNP/NPN · Wiring diagram no. 3 · Connector groups 8, 10, 18, 20, 120, 124, 126, 128, 157

	-100...600 / -148...1112	G ½ A	Display unit	18...32	50	250	5	TR2439
---	--------------------------	-------	--------------	---------	----	-----	---	--------

M12 connector · Output function 2 x normally open / closed programmable · DC PNP/NPN · Wiring diagram no. 3 · Connector groups 8, 10, 18, 20, 120, 124, 126, 128, 157

	-100...600 / -148...1112	G ½ A	Display unit	18...32	50	250	5	TR7439
---	--------------------------	-------	--------------	---------	----	-----	---	--------

Modular temperature transmitters

Type	Factory setting [°C / °F]	Process connection	U _b [V]	Ambient temperature [°C]	Measuring element	Drawing no.	Order no.
------	------------------------------	--------------------	-----------------------	-----------------------------	-------------------	-------------	-----------

M12 connector · Output function 4...20 mA analogue · DC · Wiring diagram no. 7 · Connector groups 8, 10, 18, 20, 120, 124, 126, 128, 157

	-50...300 / -	M12	20...32	-25...70	for Pt100 and Pt1000 measuring elements	6	TP3232
	0...100 / -	M12	20...32	-25...70	for Pt100 and Pt1000 measuring elements	6	TP3237
	-50...150 / -	M12	20...32	-25...70	for Pt100 and Pt1000 measuring elements	6	TP3231
	-18...149 / 0...300	M12	20...32	-25...70	for Pt100 and Pt1000 measuring elements	6	TP3233

M12 connector · Output function 0...10 V analogue · DC · Wiring diagram no. 8 · Connector groups 8, 10, 18, 20, 120, 124, 126, 128, 157

	0...100 / -	M12	18...32	-25...70	for Pt100 and Pt1000 measuring elements	6	TP9237
---	-------------	-----	---------	----------	---	---	--------

Pt1000 probe sensors for industrial applications

Type	Measuring range [°C]	Diameter [mm]	Installation length [mm]	Sensor element	Dynamic response T05 / T09 [s]	Drawing no.	Order no.
------	-------------------------	------------------	-----------------------------	----------------	--------------------------------------	-------------	-----------

M12 connector · high-grade stainless steel · Wiring diagram no. 4

	-40...150	10	160	1 x Pt 1000	1 / 3	7	TT1050
	-40...150	10	260	1 x Pt 1000	1 / 3	7	TT2050

You can find wiring diagrams and scale drawings from page 556

Process sensors

Type	Measuring range [°C]	Diameter [mm]	Installation length [mm]	Sensor element	Dynamic response T05 / T09 [s]	Drawing no.	Order no.
------	-------------------------	------------------	-----------------------------	----------------	--------------------------------------	-------------	-----------



M12 connector · high-grade stainless steel · Wiring diagram no. 4

	-40...150	10	360	1 x Pt 1000	1 / 3	7	TT3050
	-40...150	10	560	1 x Pt 1000	1 / 3	7	TT5050

Pt100 probe sensors for industrial applications

Type	Measuring range [°C]	Diameter [mm]	Installation length [mm]	Sensor element	Dynamic response T05 / T09 [s]	Drawing no.	Order no.
------	-------------------------	------------------	-----------------------------	----------------	--------------------------------------	-------------	-----------

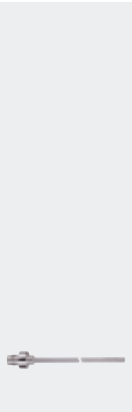
M12 connector · high-grade stainless steel · Connector groups 8, 10, 18, 20, 120, 124, 126, 128, 157

	-40...150	6	70	1 x Pt 100	1 / 3	8	TT7281
	-40...150	6	100	1 x Pt 100	1 / 3	8	TT0281
	-40...150	6	150	1 x Pt 100	1 / 3	8	TT1281
	-40...150	6	250	1 x Pt 100	1 / 3	8	TT2281
	-40...150	6	300	1 x Pt 100	1 / 3	8	TT6281
	-40...150	6	350	1 x Pt 100	1 / 3	8	TT3281
	-40...150	6	50	1 x Pt 100	1 / 3	8	TT9281
	-40...150	10	160	1 x Pt 100	1 / 3	7	TT1081
	-40...150	10	260	1 x Pt 100	1 / 3	7	TT2081
	-40...150	10	360	1 x Pt 100	1 / 3	7	TT3081
	-40...150	10	560	1 x Pt 100	1 / 3	7	TT5081
	-40...125	8.2	60	1 x Pt 100	1 / 3	9	TM9950

Type	Measuring range [°C]	Diameter [mm]	Installation length [mm]	Sensor element	Dynamic response T05 / T09 [s]	Drawing no.	Order no.
------	-------------------------	------------------	-----------------------------	----------------	--------------------------------------	-------------	-----------



M12 connector · titanium · Connector groups 8, 10, 18, 20, 120, 124, 126, 128, 157

	-40...125	8.2	60	1 x Pt 100	1 / 3	9	TM9900
---	-----------	-----	----	------------	-------	---	--------

Screw-in sensors for industrial applications

Type	Measuring range [°C]	Process connection	Installation length [mm]	Sensor element	Dynamic response T05 / T09 [s]	Drawing no.	Order no.
------	-------------------------	--------------------	-----------------------------	----------------	--------------------------------------	-------------	-----------

M12 connector · high-grade stainless steel · Connector groups 8, 10, 18, 20, 120, 124, 126, 128, 157

	-40...150	G ¼	25	1 x Pt 100	1 / 3	10	TM4101
	-40...150	G ¼	25	1 x Pt 1000	1 / 3	10	TM5101
	-40...150	G ½	50	1 x Pt 100	1 / 3	11	TM4411
	-40...150	G ½	50	1 x Pt 1000	1 / 3	11	TM5411
	-40...150	G ½	100	1 x Pt 100	1 / 3	11	TM4431
	-40...150	G ½	150	1 x Pt 100	1 / 3	11	TM4441
	-40...150	G ½	250	1 x Pt 100	1 / 3	11	TM4461

Cable sensors for industrial applications

Type	Measuring range [°C]	Diameter [mm]	Cable material	Sensor element	Dynamic response T05 / T09 [s]	Drawing no.	Order no.
------	-------------------------	------------------	----------------	----------------	--------------------------------------	-------------	-----------

Cable 4 m · high-grade stainless steel

	-30...180	M5	silicone cable	1 x Pt 100	3 / 8	12	TS4759
---	-----------	----	----------------	------------	-------	----	--------

Cable with connector 0.15 m · high-grade stainless steel · Connector groups 8, 10, 18, 20, 120, 124, 126, 128, 157

	-50...250	Ø 6 mm	PTFE cable	1 x Pt 1000	11 / 37	13	TS9256
---	-----------	--------	------------	-------------	---------	----	--------

Type	Measuring range [°C]	Diameter [mm]	Cable material	Sensor element	Dynamic response T05 / T09 [s]	Drawing no.	Order no.
Cable with connector 2 m · high-grade stainless steel · Connector groups 8, 10, 18, 20, 120, 124, 126, 128, 157							
	-40...90	Ø 6 mm / L = 45 mm	PUR cable	1 x Pt 100	3 / 10	14	TS2289
	-40...90	Ø 10 mm	PUR cable	1 x Pt 100	6 / 25	15	TS2089
	-50...250	Ø 6 mm	PTFE cable	1 x Pt 100	11 / 37	13	TS2256
	-50...250	Ø 10 mm	PTFE cable	1 x Pt 100	12 / 39	16	TS2056
	-30...90	M5 / L = 25.7	PUR cable	1 x Pt 100	3 / 8	17	TS2789
	-40...90	M6 / L = 26	PUR cable	1 x Pt 100	3 / 9	18	TS2689
	-30...180	M5 / L = 25.7	silicone cable	1 x Pt 100	3 / 8	19	TS2759
	-30...180	M6	silicone cable	1 x Pt 100	3 / 8	20	TS2659
Cable with connector 2.5 m · high-grade stainless steel · Connector groups 8, 10, 18, 20, 120, 124, 126, 128, 157							
	-40...90	Ø 6 mm / L = 45 mm	PUR cable	1 x Pt 100	3 / 10	14	TS9289
Cable with connector 5 m · high-grade stainless steel · Connector groups 8, 10, 18, 20, 120, 124, 126, 128, 157							
	-40...90	Ø 10 mm	PUR cable	1 x Pt 100	6 / 25	15	TS5089
	-40...90	Ø 6 mm / L = 45 mm	PUR cable	1 x Pt 100	3 / 10	14	TS5289
Cable with connector 10 m · high-grade stainless steel · Connector groups 8, 10, 18, 20, 120, 124, 126, 128, 157							
	-30...180	M5 / L = 25.7	silicone cable	1 x Pt 100	3 / 8	19	TS0759

Cable sensors with bolt-on sensor for industrial applications

Type	Measuring range [°C]	Diameter [mm]	Cable material	Sensor element	Dynamic response T05 / T09 [s]	Drawing no.	Order no.
------	-------------------------	------------------	----------------	----------------	--------------------------------------	-------------	-----------

Cable with connector 2 m · stainless steel · Connector groups 8, 10, 18, 20, 120, 124, 126, 128, 157

	-40...90	12	PUR cable	1 x Pt 100	9 / 15	21	TS2229
---	----------	----	-----------	------------	--------	----	--------

Cable 2 m · stainless steel

	-40...90	12	PUR cable	1 x Pt 100	12 / 39	22	TS2239
---	----------	----	-----------	------------	---------	----	--------

Screw-in sensor with ATEX approval 3D/3G

Type	Measuring range [°C]	Diameter [mm]	Cable material	Sensor element	Dynamic response T05 / T09 [s]	Drawing no.	Order no.
------	-------------------------	------------------	----------------	----------------	--------------------------------------	-------------	-----------

Cable 2 m · high-grade stainless steel · DC

	-20...115	M5	silicone cable	1 x Pt 100	8 / 20	23	TS285A
---	-----------	----	----------------	------------	--------	----	--------

Cable sensors for ATEX applications 3D/3G

Type	Measuring range [°C]	Diameter [mm]	Cable material	Sensor element	Dynamic response T05 / T09 [s]	Drawing no.	Order no.
------	-------------------------	------------------	----------------	----------------	--------------------------------------	-------------	-----------



Cable 3 m · high-grade stainless steel

	-20...80	Ø 5/6 mm / L = 40	silicone cable	1 x Pt 100	4 / 10	24	TS325A
---	----------	-------------------	----------------	------------	--------	----	--------











Cable sensors with bolt-on sensors for ATEX 3D / 3G applications

Type	Measuring range [°C]	Diameter [mm]	Cable material	Sensor element	Dynamic response T05 / T09 [s]	Drawing no.	Order no.
------	-------------------------	------------------	----------------	----------------	--------------------------------------	-------------	-----------

Cable 5 m · high-grade stainless steel





	-20...80	10	silicone cable	1 x Pt 100	13 / 39	25	TS522A
	-20...80	18	silicone cable	1 x Pt 1000	18 / 42	26	TS502A

IO-Link temperature transmitters

Type	Factory setting [°C / °F]	Process connection	Installation length [mm]	U _b [V]	Dynamic response T05 / T09 [s]	Drawing no.	Order no.
M12 connector · high-grade stainless steel · DC · Connector groups 8, 10, 18, 20, 120, 124, 126, 128, 157							
	-50...150 / -	G ½	30	18...32	1 / 3	27	TA2405
	-50...150 / -	G ½	50	18...32	1 / 3	27	TA2415
	0...100 / -	G ½	50	18...32	1 / 3	28	TA2417
	-50...150 / -	G ½	100	18...32	1 / 3	27	TA2435
	0...100 / -	G ½	100	18...32	1 / 3	28	TA2437
	-50...150 / -	G ½	150	18...32	1 / 3	27	TA2445
	0...100 / -	G ½	150	18...32	1 / 3	28	TA2447
	-50...150 / -	G ¼	25	18...32	1 / 3	29	TA2105
	-50...150 / -	G ¼	50	18...32	1 / 3	29	TA2115
	-50...150 / -	G ¼	100	18...32	1 / 3	29	TA2135
	-50...150 / -	G ¼	150	18...32	1 / 3	29	TA2145
	0...300- /	½" NPT	30	18...32	1 / 3	30	TA2303
	0...300- /	½" NPT	50	18...32	1 / 3	30	TA2313
	0...300- /	½" NPT	100	18...32	1 / 3	30	TA2333
	0...300- /	½" NPT	150	18...32	1 / 3	30	TA2343

Type	Factory setting [°C / °F]	Process connection	Installation length [mm]	U _b [V]	Dynamic response T05 / T09 [s]	Drawing no.	Order no.
------	------------------------------	--------------------	-----------------------------	-----------------------	--------------------------------------	-------------	-----------

M12 connector · high-grade stainless steel · DC · Connector groups 8, 10, 18, 20, 120, 124, 126, 128, 157

	0...300- /	¼" NPT	25	18...32	1 / 3	31	TA2603
	0...300- /	¼" NPT	50	18...32	1 / 3	31	TA2613
	0...300- /	¼" NPT	100	18...32	1 / 3	31	TA2633
	0...300- /	¼" NPT	150	18...32	1 / 3	31	TA2643

Probe sensors for hygienic and wet areas

Type	Measuring range [°C]	Diameter [mm]	Installation length [mm]	Sensor element	Dynamic response T05 / T09 [s]	Drawing no.	Order no.
------	-------------------------	------------------	-----------------------------	----------------	--------------------------------------	-------------	-----------

M12 connector · high-grade stainless steel · Connector groups 8, 10, 18, 20, 120, 124, 126, 128, 157





	-40...150	6	50	1 x Pt 100	1 / 3	8	TT9291
	-40...150	6	100	1 x Pt 100	1 / 3	8	TT0291
	-40...150	6	150	1 x Pt 100	1 / 3	8	TT1291
	-40...150	6	250	1 x Pt 100	1 / 3	8	TT2291
	-40...150	6	350	1 x Pt 100	1 / 3	8	TT3291

Sensors with process connection for hygienic and wet areas



Type	Measuring range [°C]	Process connection	Installation length [mm]	Sensor element	Dynamic response T05 / T09 [s]	Drawing no.	Order no.
------	-------------------------	--------------------	-----------------------------	----------------	--------------------------------------	-------------	-----------







M12 connector · high-grade stainless steel · Connector groups 8, 10, 18, 20, 120, 124, 126, 128, 157

	-40...150	Clamp 1-1.5" ISO 2852	30	1 x Pt 100	1 / 3	32	TM4801
	-40...150	Clamp 1-1.5" ISO 2852	50	1 x Pt 100	1 / 3	32	TM4811

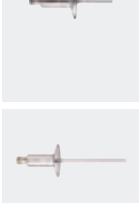
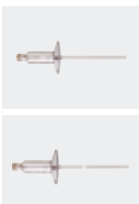
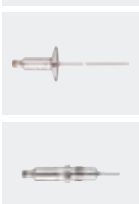
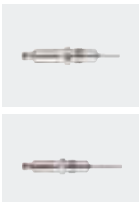
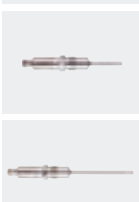
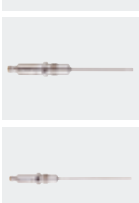



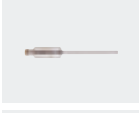

Type	Measuring range [°C]	Process connection	Installation length [mm]	Sensor element	Dynamic response T05 / T09 [s]	Drawing no.	Order no.
M12 connector · high-grade stainless steel · Connector groups 8, 10, 18, 20, 120, 124, 126, 128, 157							
	-40...150	Clamp 1-1.5" ISO 2852	100	1 x Pt 100	1 / 3	32	TM4831
	-40...150	Clamp 1-1.5" ISO 2852	150	1 x Pt 100	1 / 3	32	TM4841
	-40...150	Clamp 2"	30	1 x Pt 100	1 / 3	33	TM4901
	-40...150	Clamp 2"	50	1 x Pt 100	1 / 3	33	TM4911
	-40...150	Clamp 2"	100	1 x Pt 100	1 / 3	33	TM4931
	-40...150	Clamp 2"	150	1 x Pt 100	1 / 3	33	TM4941
	-40...150	G½ with sealing cone	20	1 x Pt 100	1 / 3	34	TM4591
	-40...150	G½ with sealing cone	30	1 x Pt 100	1 / 3	34	TM4501
	-40...150	G½ with sealing cone	50	1 x Pt 100	1 / 3	34	TM4511
	-40...150	G½ with sealing cone	100	1 x Pt 100	1 / 3	34	TM4531
	-40...150	G½ with sealing cone	150	1 x Pt 100	1 / 3	34	TM4541
	-50...140	G½ with sealing cone	-	1 x Pt 100	10 / 40	35	TM4599

Temperature transmitters for hygienic and wet areas

Type	Measuring range [°C / °F]	Process connection	Installation length [mm]	U _b [V]	Dynamic response T05 / T09 [s]	Drawing no.	Order no.
M12 connector · high-grade stainless steel · DC · Connector groups 120, 124, 126							
	-50...200 / -	3/4" clamp (ISO 2852)	25	18...32	< 0.5 / < 2.0	36	TA2002
	-50...200 / -	3/4" clamp (ISO 2852)	60	18...32	< 0.5 / < 2.0	36	TA2012



Type	Measuring range [°C / °F]	Process connection	Installation length [mm]	U _b [V]	Dynamic response T05 / T09 [s]	Drawing no.	Order no.
M12 connector · high-grade stainless steel · DC · Connector groups 120, 124, 126							
	-50...200 / -	1.5" clamp (ISO 2852)	30	18...32	< 0.5 / < 2	37	TA2802
	-50...200 / -	1.5" clamp (ISO 2852)	50	18...32	< 0.5 / < 2	37	TA2812
	-50...200 / -	1.5" clamp (ISO 2852)	100	18...32	< 0.5 / < 2	37	TA2832
	-50...200 / -	1.5" clamp (ISO 2852)	150	18...32	< 0.5 / < 2	37	TA2842
	-50...200 / -	G $\frac{1}{2}$ with sealing cone	30	18...32	< 0.5 / < 2	38	TA2502
	-50...200 / -	G $\frac{1}{2}$ with sealing cone	50	18...32	< 0.5 / < 2	38	TA2512
	-50...200 / -	G $\frac{1}{2}$ with sealing cone	100	18...32	< 0.5 / < 2	38	TA2532
	-50...200 / -	G $\frac{1}{2}$ with sealing cone	150	18...32	< 0.5 / < 2	38	TA2542
M12 connector · high-grade stainless steel · DC · Connector group --							
	0...100 / -	G $\frac{1}{2}$ with sealing cone	-	18...32	10 / 40	39	TA3597
M12 connector · high-grade stainless steel · DC · Connector groups 120, 124, 126							
	-50...200 / -	Ø 6 mm	50	18...32	< 0.5 / < 2	40	TA2212
	-50...200 / -	Ø 6 mm	100	18...32	< 0.5 / < 2	40	TA2232
	-50...200 / -	Ø 6 mm	150	18...32	< 0.5 / < 2	40	TA2242

Self-monitoring temperature transmitters for hygienic and wet areas, IO-Link



Type	Factory setting [°C / °F]	Process connection	Installation length [mm]	U _b [V]	Dynamic response T05 / T09 [s]	Drawing no.	Order no.
	0...150 / 32...302	Aseptoflex Vario	50	18...32	3 / 6	41	TAD081
	0...150 / 32...302	Aseptoflex Vario	87.5	18...32	3 / 6	42	TAD181
	0...150 / 32...302	Aseptoflex Vario	33	18...32	3 / 6	43	TAD981
	0...150 / 32...302	G 1/2 A	50	18...32	3 / 6	44	TAD091
	0...150 / 32...302	G 1/2 A	87.5	18...32	3 / 6	45	TAD191
	0...150 / 32...302	G 1/2 A	33	18...32	3 / 6	46	TAD991

Temperature transmitter with display for hygienic and wet areas, IO-Link

Type	Factory setting [°C / °F]	Process connection	Installation length [mm]	U _b [V]	Dynamic response T05 / T09 [s]	Drawing no.	Order no.
	0...100 / -	G _{1/2} with sealing cone	30	18...32	1 / 3	47	TD2507
	0...100 / -	G _{1/2} with sealing cone	50	18...32	1 / 3	47	TD2517
	0...100 / -	G _{1/2} with sealing cone	100	18...32	1 / 3	47	TD2537
	0...100 / -	G _{1/2} with sealing cone	150	18...32	1 / 3	47	TD2547
	-10...150 / -	G _{1/2} with sealing cone	30	18...32	1 / 3	47	TD2501
	-10...150 / -	G _{1/2} with sealing cone	50	18...32	1 / 3	47	TD2511
	-10...150 / -	G _{1/2} with sealing cone	100	18...32	1 / 3	47	TD2531









Type	Factory setting [°C / °F]	Process connection	Installation length [mm]	U _b [V]	Dynamic response T05 / T09 [s]	Drawing no.	Order no.
M12 connector · DC · Wiring diagram no. 10 · Connector groups 8, 10, 18, 20, 120, 124, 126, 128, 157							
	-10...150 / -	G _{1/2} with sealing cone	150	18...32	1 / 3	47	TD2541
	0...100 / -	1.5" clamp (ISO 2852)	30	18...32	1 / 3	48	TD2807
	0...100 / -	1.5" clamp (ISO 2852)	50	18...32	1 / 3	48	TD2817
	0...100 / -	1.5" clamp (ISO 2852)	100	18...32	1 / 3	48	TD2837
	0...100 / -	1.5" clamp (ISO 2852)	150	18...32	1 / 3	48	TD2847
	-10...150 / -	1.5" clamp (ISO 2852)	30	18...32	1 / 3	48	TD2801
	-10...150 / -	1.5" clamp (ISO 2852)	50	18...32	1 / 3	48	TD2811
	-10...150 / -	1.5" clamp (ISO 2852)	100	18...32	1 / 3	48	TD2831
	-10...150 / -	1.5" clamp (ISO 2852)	150	18...32	1 / 3	48	TD2841
	0...300- /	1.5" clamp (ISO 2852)	30	18...32	1 / 3	48	TD2803
	0...300- /	1.5" clamp (ISO 2852)	50	18...32	1 / 3	48	TD2813
	0...300- /	1.5" clamp (ISO 2852)	100	18...32	1 / 3	48	TD2833
	0...300- /	1.5" clamp (ISO 2852)	150	18...32	1 / 3	48	TD2843
	0...100 / -	2" clamp (ISO 2852)	30	18...32	1 / 3	49	TD2907
	0...100 / -	2" clamp (ISO 2852)	50	18...32	1 / 3	49	TD2917
	0...100 / -	2" clamp (ISO 2852)	100	18...32	1 / 3	49	TD2937
	0...100 / -	2" clamp (ISO 2852)	150	18...32	1 / 3	49	TD2947

You can find wiring diagrams and scale drawings from page 556

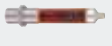

Type	Factory setting [°C / °F]	Process connection	Installation length [mm]	U _b [V]	Dynamic response T05 / T09 [s]	Drawing no.	Order no.
M12 connector · DC · Wiring diagram no. 10 · Connector groups 8, 10, 18, 20, 120, 124, 126, 128, 157							
	-10...150 / -	2" clamp (ISO 2852)	30	18...32	1 / 3	49	TD2901
	-10...150 / -	2" clamp (ISO 2852)	50	18...32	1 / 3	49	TD2911
	-10...150 / -	2" clamp (ISO 2852)	100	18...32	1 / 3	49	TD2931
	-10...150 / -	2" clamp (ISO 2852)	150	18...32	1 / 3	49	TD2941
	0...300- /	2" clamp (ISO 2852)	30	18...32	1 / 3	49	TD2903
	0...300- /	2" clamp (ISO 2852)	50	18...32	1 / 3	49	TD2913
	0...300- /	2" clamp (ISO 2852)	100	18...32	1 / 3	49	TD2933
	0...300- /	2" clamp (ISO 2852)	150	18...32	1 / 3	49	TD2943
	0...100 / -	Ø 6 mm	50	18...32	1 / 3	50	TD2217
	0...100 / -	Ø 6 mm	100	18...32	1 / 3	50	TD2237
	0...100 / -	Ø 6 mm	150	18...32	1 / 3	50	TD2247
	0...100 / -	Ø 6 mm	250	18...32	1 / 3	50	TD2267
	-10...150 / -	Ø 6 mm	50	18...32	1 / 3	50	TD2211
	-10...150 / -	Ø 6 mm	100	18...32	1 / 3	50	TD2231
	-10...150 / -	Ø 6 mm	150	18...32	1 / 3	50	TD2241
	-10...150 / -	Ø 6 mm	250	18...32	1 / 3	50	TD2261
	-10...150 / -	Ø 6 mm	200	18...32	1 / 3	50	TD2251

Type	Factory setting [°C / °F]	Process connection	Installation length [mm]	U _b [V]	Dynamic response T05 / T09 [s]	Drawing no.	Order no.
M12 connector · DC · Wiring diagram no. 10 · Connector groups 8, 10, 18, 20, 120, 124, 126, 128, 157							
	0...300 / -	Ø 6 mm	200	18...32	1 / 3	50	TD2253
	0...100 / -	Ø 6 mm	200	18...32	1 / 3	50	TD2257
	-10...150 / -	Ø 6 mm	300	18...32	1 / 3	50	TD2271
	0...300 / -	Ø 6 mm	300	18...32	1 / 3	50	TD2273
	0...100 / -	Ø 6 mm	300	18...32	1 / 3	50	TD2277
	-10...150 / -	Ø 6 mm	350	18...32	1 / 3	50	TD2291
	0...300 / -	Ø 6 mm	350	18...32	1 / 3	50	TD2293
	0...100 / -	Ø 6 mm	350	18...32	1 / 3	50	TD2297



Infrared temperature sensors

Type	Temperature range [°C]	Wave length range [µm]	Material lens	Response time [ms]	Drawing no.	Order no.
M12 connector · Output function  /  · Switching output, Analogue output · DC PNP · Wiring diagram no. 5 · Connector group --						
	0...999.5	8...14	Infrared transparent crystal lens with anti-reflex coating	< 100	51	TW2000
	250...1600	1.0...1.7	tempered optical glass	< 2	52	TW2001
	500...2500	0.78...1.06	tempered optical glass	< 2	52	TW2002
	300...1600	1.0...1.7	tempered optical glass	< 2	53	TW2011
M12 connector · Output function  /  · 2 switching outputs · DC PNP · Wiring diagram no. 5 · Connector group --						
	50...500	8...14	Infrared transparent crystal lens with anti-reflex coating	< 100	54	TW7000

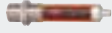

Process sensors





Type	Temperature range [°C]	Wave length range [µm]	Material lens	Response time [ms]	Drawing no.	Order no.
M12 connector · Output function  /  · 2 switching outputs · DC PNP · Wiring diagram no. 5 · Connector group --						
	250...1250	1.0...1.7	tempered optical glass	≤ 2	55	TW7001
	350...1350	1.0...1.7	tempered optical glass	≤ 2	56	TW7011

Accessories for temperature sensors TN / TR

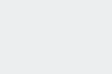



Type	Description	Order no.
	Angle bracket · Housing materials: PA66-	E30421
	Mounting clamp · Ø 34 mm · Housing materials: PBT	E10017
	Mounting clamp · Ø 34 mm · Housing materials: PA	E10193
	Mounting device 2 way · for fluid sensors · Housing materials: POM	E30078
	Mounting device 3 way · for fluid sensors · Housing materials: POM	E30079
	Protective cover · for fluid sensors with M12 connector · Housing materials: polyurethane	E30006

Accessories for infrared temperature sensors

Type	Description	Order no.
	Measuring head · for infrared temperature sensors TWxx11, M30 design · Housing materials: AlMg3 black anodised / 303 / 1.4305 / lock nuts: 304 / 1.4301 / O-ring: FPM	E35060
	Fibre optics with stainless steel sheathing · straight · Connection to infrared temperature sensors TWxx11 · ¼"-36UNS-2A · Housing materials: stainless steel, Fibre optic: Quartz/Quartz fibre (VIS/IR)	E35061
	Fibre optics with stainless steel sheathing · straight · Connection to infrared temperature sensors TWxx11 · ¼"-36UNS-2A · Housing materials: stainless steel, Fibre optic: Quartz/Quartz fibre (VIS/IR)	E35062

Type	Description	Order no.
	Air purge · for infrared temperature sensors TWxxxx, M30 design · for type TW · Housing materials: stainless steel / Brass / sealing ring: aluminium	E35063
	Cooling jacket · for infrared temperature sensors TWxxxx, M30 design · for type TW · Housing materials: 304 / 1.4301	E35068
	Mounting bracket · Ø 30 mm · for types M30 · Housing materials: Steel galvanised	E35065
	Protective tube · for infrared temperature sensors TWxxxx, M30 design · for type TW · Housing materials: stainless steel	E35066
	Insulating tube · for infrared temperature sensors TWxxxx, M30 design · for type TW · Housing materials: POM	E35067

Accessories and software

Type	Description	Order no.
	IO-Link interface · for parameter setting and analysis of units with max. 65 mA current consumption · Supported communication protocols: IO-Link (4800 and 38400 bits/s) EPS protocol (19200 bits/s) · for operation with FDT framework software "ifm Container" or software "LINERECORDER SENSOR"	E30396
	LINERECORDER SENSOR · Version 4.0.0 · Software for clear online and offline parameter setting of IO-Link sensors via USB adapter · Use via USB connection cable (drivers are supplied): E30396 IO-Link interface or E30390 IO-Link master (note the respective data sheet) · IODD import and update from ifm's homepage · Reading of IODDs via storage media · Automatic sensor identification · Graphic representation of the process values and history incl. export function · Documentation and archiving · Transferable parameter sets · Full memory plug support for IO-Link 1.1	QA0001
	Memory plug · Parameter memory for IO-Link sensors · Storage capacity: 2 Kbytes · Housing materials: PA PACM 12 / PET / sealing: FPM / nut: stainless steel 316L / 1.4404 / connector: TPU	E30398
	Teach button · for sensors PP0xE, PP052x, PP755x · for memory plug (E30398) · 0.9 m · Housing materials: stainless steel / PA / PMMA	E30405
	USB IO-Link master · for parameter setting and analysis of units · Supported communication protocols: IO-Link (4.8, 38.4 and 230 Kbits/s) · for operation with FDT framework software "ifm Container" or software "LINERECORDER SENSOR"	E30390

Certificates

Description	Order no.
DAkKS calibration certificate for temperature sensors · Number of measuring points: 3-point DAkKS calibration · Measurement points [°C]: 65, 85, 123 (to directive DAkKS-DKD-R 5-1) · Minimum measurement uncertainty [K]: 0.1	ZC0013
DAkKS calibration certificate for temperature sensors · Number of measuring points: 5-point DAkKS calibration · Measurement points [°C]: 20, 65, 85, 100, 123 (to directive DAkKS-DKD-R 5-1) · Minimum measurement uncertainty [K]: 0.1	ZC0014

Description	Order no.
DAkKS calibration certificate for temperature sensors · Number of measuring points: n-point DAkKS calibration · Measurement points [°C]: number and positions as requested by the customer, maximum 4 points in the range from -20...150 °C (to directive DAkKS-DKD-R 5-1) · Minimum measurement uncertainty [K]: 0.1	ZC0015
Factory calibration certificate for temperature sensors · Number of measuring points: 3-point factory calibration · Measurement points [°C]: 65, 85, 123 (to ISO 9001) · Minimum measurement uncertainty [K]: 0.1	ZC0016
Factory calibration certificate for temperature sensors · Number of measuring points: 5-point factory calibration · Measurement points [°C]: 20, 65, 85, 100, 123 (to ISO 9001) · Minimum measurement uncertainty [K]: 0.1	ZC0017
Factory calibration certificate for temperature sensors · Number of measuring points: n-point factory calibration · Measurement points [°C]: number and positions as requested by the customer, maximum 4 points in the range from -20...150 °C (to ISO 9001) · Minimum measurement uncertainty [K]: 0.1	ZC0018
Factory calibration sheet for first delivery of infrared temperature sensors · TW2000 / TW2001 / TW2002 / TW2011 · Minimum measurement uncertainty [K]: ± 4	ZC0061

Thermowells for temperature sensors



Type	Description	Order no.
	Welding thermowell · Ø 35 mm · Probe length: 126.5 mm · for type TA343x, TAA431, TAD191 · Housing materials: stainless steel 316L / 1.4404	E30403
	Thermowell for temperature sensors · G ½ · Probe length: 53 mm · for type TA34xx, TAA431, TAD191 · Housing materials: stainless steel 316L / 1.4404	E30393
	Thermowell for temperature sensors · G ½ - ½" NPT · Probe length: 69 mm · for type TA34xx, TAA4xx · Housing materials: stainless steel 316L / 1.4404	E30397
	Thermowell for temperature sensors · Ø 10 mm - G ½ · Probe length: 82 mm · Housing materials: stainless steel 316L / 1.4404	E35010
	Thermowell for temperature sensors · Ø 10 mm - G ½ · Probe length: 182 mm · Housing materials: stainless steel 316L / 1.4404	E35020
	Thermowell for temperature sensors · Ø 10 mm - G ½ · Probe length: 282 mm · Housing materials: stainless steel 316L / 1.4404	E35030
	Thermowell for temperature sensors · Ø 10 mm - G ½ · Probe length: 482 mm · Housing materials: stainless steel 316L / 1.4404	E35050
	Thermowell for temperature sensors · Ø 6 mm · Installation length EL: 74 mm · for temperature sensors with installation length EL = 100 mm · Housing materials: stainless steel 316L / 1.4404	E37210
	Thermowell for temperature sensors · Ø 6 mm · Installation length EL: 94 mm · for temperature sensors with installation length EL = 100 mm · Housing materials: stainless steel 316L / 1.4404	E37211











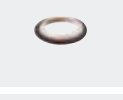

Type	Description	Order no.
	Thermowell for temperature sensors · Ø 6 mm · Installation length EL: 125 mm · for temperature sensors with installation length EL = 150 mm · Housing materials: stainless steel 316L / 1.4404	E37220
	Thermowell for temperature sensors · Ø 6 mm · Installation length EL: 144 mm · for temperature sensors with installation length EL = 150 mm · Housing materials: stainless steel 316L / 1.4404	E37221
	Thermowell for temperature sensors · Ø 6 mm · Installation length EL: 201 mm · for temperature sensors with installation length EL = 300 mm · Housing materials: stainless steel 316L / 1.4404	E37230
	Thermowell for temperature sensors · Ø 6 mm · Installation length EL: 277 mm · for temperature sensors with installation length EL = 350 mm · Housing materials: stainless steel 316L / 1.4404	E37250
	Thermowell for temperature sensors · Ø 6 mm · Installation length EL: 64 mm · for temperature sensors with installation length EL = 100 mm · Housing materials: stainless steel 316L / 1.4404	E37810
	Thermowell for temperature sensors · Ø 6 mm · Installation length EL: 115 mm · for temperature sensors with installation length EL = 150 mm · Housing materials: stainless steel 316L / 1.4404	E37820
	Thermowell for temperature sensors · Ø 6 mm · Installation length EL: 191 mm · for temperature sensors with installation length EL = 300 mm · Housing materials: stainless steel 316L / 1.4404	E37830
	Thermowell for temperature sensors · Ø 6 mm · Installation length EL: 267 mm · for temperature sensors with installation length EL = 350 mm · Housing materials: stainless steel 316L / 1.4404	E37850
	Thermowell for temperature sensors · Ø 6 mm · Installation length EL: 64 mm · for temperature sensors with installation length EL = 100 mm · Housing materials: stainless steel 316L / 1.4404	E37910
	Thermowell for temperature sensors · Ø 6 mm · Installation length EL: 115 mm · for temperature sensors with installation length EL = 150 mm · Housing materials: stainless steel 316L / 1.4404	E37920
	Thermowell for temperature sensors · Ø 6 mm · Installation length EL: 191 mm · for temperature sensors with installation length EL = 300 mm · Housing materials: stainless steel 316L / 1.4404	E37930
	Thermowell for temperature sensors · Ø 6 mm · Installation length EL: 267 mm · for temperature sensors with installation length EL = 350 mm · Housing materials: stainless steel 316L / 1.4404	E37950
	Thermowell for temperature sensors · Ø 6 mm · Installation length EL: 33 mm · for temperature sensors with installation length EL = 50 mm · Housing materials: stainless steel 316Ti / 1.4571	E37603
	Thermowell for temperature sensors · Ø 6 mm · Installation length EL: 83 mm · for temperature sensors with installation length EL = 100 mm · Housing materials: stainless steel 316Ti / 1.4571	E37613
	Thermowell for temperature sensors · Ø 6 mm · Installation length EL: 128 mm · for temperature sensors with installation length EL = 150 mm · Housing materials: stainless steel 316Ti / 1.4571	E37623
	Thermowell for temperature sensors · Ø 6 mm · Installation length EL: 233 mm · for temperature sensors with installation length EL = 250 mm · Housing materials: stainless steel 316Ti / 1.4571	E37643

Process sensors

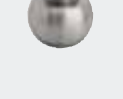
Type	Description	Order no.
	Thermowell for temperature sensors · Ø 6 mm · Installation length EL: 333 mm · for temperature sensors with installation length EL = 350 mm · Housing materials: stainless steel 316Ti / 1.4571	E37663
	Thermowell for temperature sensors · Ø 6 mm · Installation length EL: 68 mm · for temperature sensors with installation length EL = 100 mm · Housing materials: stainless steel 316L / 1.4404	E37511
	Thermowell for temperature sensors · Ø 6 mm · Installation length EL: 118 mm · for temperature sensors with installation length EL = 150 mm · Housing materials: stainless steel 316L / 1.4404	E37521
	Thermowell for temperature sensors · Ø 6 mm · Installation length EL: 27 mm · for temperature sensors with installation length EL = 50 mm · Housing materials: stainless steel 316L / 1.4404	E37600
	Thermowell for temperature sensors · Ø 6 mm · Installation length EL: 74 mm · for temperature sensors with installation length EL = 100 mm · Housing materials: stainless steel 316L / 1.4404	E37610
	Thermowell for temperature sensors · Ø 6 mm · Installation length EL: 124 mm · for temperature sensors with installation length EL = 150 mm · Housing materials: stainless steel 316L / 1.4404	E37620
	Thermowell for temperature sensors · Ø 6 mm · Installation length EL: 224 mm · for temperature sensors with installation length EL = 250 mm · Housing materials: stainless steel 316L / 1.4404	E37640
	Welding thermowell for temperature sensors · Ø 6 mm · Installation length EL: 49 mm · for temperature sensors with installation length EL = 50 mm · Housing materials: stainless steel 316L / 1.4404	E37411
	Welding thermowell for temperature sensors · Ø 6 mm · Installation length EL: 99 mm · for temperature sensors with installation length EL = 100 mm · Housing materials: stainless steel 316L / 1.4404	E37421
	Welding thermowell for temperature sensors · Ø 6 mm · Installation length EL: 149 mm · for temperature sensors with installation length EL = 150 mm · Housing materials: stainless steel 316L / 1.4404	E37431
	Welding thermowell for temperature sensors · Ø 6 mm · Installation length EL: 191 mm · for temperature sensors with installation length EL = 300 mm · Housing materials: stainless steel 316L / 1.4404	E37430
	Welding thermowell for temperature sensors · Ø 6 mm · Installation length EL: 267 mm · for temperature sensors with installation length EL = 350 mm · Housing materials: stainless steel 316L / 1.4404	E37450

Adapters

Type	Description	Order no.
	Thread cover · Ø 24 mm - G ½ · Ø 24 mm · to cover the G½ thread for installation in hygienic areas · for type TR · Housing materials: stainless steel	E30091
	Mounting set · for direct connection of temperature sensors TT to control monitors TR · Housing materials: stainless steel	E30017

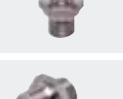
Type	Description	Order no.
	Clamp fitting · Ø 6/8/10 mm - G ½ · for temperature sensors · Housing materials: stainless steel / FPM	E30018
	Clamp fitting · Ø 6/8/10 mm - ½" NPT · for temperature sensors · Housing materials: stainless steel / FPM	E30025
	Mounting adapter · M18 x 1.5 - Ø 23 mm · PVC adapter to be glued into the pipe · Insertion depth of the probe of SID, SFD, TN: · 21 mm · Housing materials: PVC	E40148
	Sealing ring · for G ½ sealing cone · Housing materials: sealing ring on sensor side: FKM / sealing ring on process side: PEEK	E43911
	Adapter · M18 x 1.5 - G ½ · Housing materials: stainless steel 316L / 1.4404 / O-ring: FPM (fitted)	E30073
	Clamp adapter · Ø 6 mm - G ½ · no dead space · Housing materials: stainless steel 316L / 1.4404 / rubber ring: PEEK	E30144
	Welding adapter · M18 x 1.5 - Ø 24 mm · Insertion depth of the probe of SID, SFD, TN: · 15 mm · Housing materials: stainless steel 316L / 1.4404	E40124
	Welding adapter · Ø 24.7 mm · for temperature sensors Ø 6 mm · Clamp fitting · Housing materials: stainless steel 316L / 1.4404	E30108
	Welding adapter · Ø 25 mm · for temperature sensors Ø 6 mm · Clamp fitting · Housing materials: stainless steel 316L / 1.4404 / rubber ring: PEEK	E30407
	Progressive ring fitting for temperature sensors · Ø 10 mm - G ½ · Housing materials: stainless steel 316Ti / 1.4571	E30016
	Progressive ring fitting for temperature sensors · Ø 10 mm - ½" NPT · Housing materials: stainless steel 316Ti / 1.4571	E30024
	Progressive ring fitting for temperature sensors · Ø 6 mm - G ½ · Housing materials: stainless steel 316Ti / 1.4571	E30047
	Progressive ring fitting for temperature sensors · Ø 6 mm - ¼" NPT · Housing materials: stainless steel 316Ti / 1.4571	E30049
	Progressive ring fitting for temperature sensors · Ø 6 mm - G ¼ · Housing materials: stainless steel 316Ti / 1.4571	E33431
	Adapter · M18 x 1.5 - G ½ · Insertion depth of the probe of SID, SFD, TN: · 21 mm · Housing materials: titanium	E40114











Process sensors











Type	Description	Order no.
	Adapter · M18 x 1.5 - M12 x 1 · Insertion depth of the probe of SID, SFD, TN: · 13.5 mm · Housing materials: titanium	E40128
	Adapter · M18 x 1.5 - L18 · for mounting in T-pieces · Insertion depth of the probe of SID, SFD, TN: · 28.5 mm · Housing materials: nut: stainless steel 316Ti / 1.4571 / adapter: stainless steel 316L / 1.4404 / O-ring: FKM 16 x 1.5 gr 70° Shore A	E40104
	Adapter · M18 x 1.5 - M12 x 1 · Insertion depth of the probe of SID, SFD, TN: · 13.5 mm · Housing materials: stainless steel 316L / 1.4404	E40101
	Adapter · M18 x 1.5 - M12 x 1 · Insertion depth of the probe of SID, SFD, TN: · 13.5 mm · Housing materials: brass	E40100
	Adapter · M18 x 1.5 - G ¼ · Insertion depth of the probe of SID, SFD, TN: · 13.5 mm · Housing materials: stainless steel 316L / 1.4404	E40099
	Adapter · M18 x 1.5 - G ¼ · Insertion depth of the probe of SID, SFD, TN: · 13.5 mm · Housing materials: brass	E40098
	Adapter · M18 x 1.5 - G ½ · Insertion depth of the probe of SID, SFD, TN: · 21 mm · Housing materials: stainless steel 316L / 1.4404	E40096
	Adapter · M18 x 1.5 - G ½ · Insertion depth of the probe of SID, SFD, TN: · 21 mm · Housing materials: brass	E40097
	Adapter · M18 x 1.5 - ½" NPT · Insertion depth of the probe of SID, SFD, TN: · 23 mm · Housing materials: stainless steel 316L / 1.4404	E40107
	Adapter · M18 x 1.5 - G ½ · Housing materials: stainless steel 316L / 1.4404 / O-ring: FPM (fitted)	E30073
	Protective cover · with lead seal option · for pressure sensors type PK · for temperature sensors type TK · for vibration sensors type VK · Housing materials: PP transparent	E30094



Hygienic adapters

Type	Description	Order no.
Clamp adapter · 1-1.5" · Aseptoflex Vario		
	Clamp adapter · Clamp · 1-1.5" · ISO 2852 · for units with Aseptoflex Vario adapter · Sealing by sealing ring · Housing materials: stainless steel 316L / 1.4435	E33201

Type	Description	Order no.
Clamp adapter · 2" · Aseptoflex Vario		
	Clamp adapter · Clamp · 2" · ISO 2852 · for units with Aseptoflex Vario adapter · Sealing by sealing ring · Housing materials: stainless steel 316L / 1.4435	E33202
Clamp adapter · 1-1.5" · Aseptoflex Vario		
	Clamp adapter · Clamp · 1-1.5" · ISO 2852 · for units with Aseptoflex Vario adapter · Metal to metal seal · Housing materials: stainless steel 316L / 1.4435	E33701
Clamp adapter · 2" · Aseptoflex Vario		
	Clamp adapter · Clamp · 2" · ISO 2852 · for units with Aseptoflex Vario adapter · Metal to metal seal · Housing materials: stainless steel 316L / 1.4435	E33702
Hygienic pipe fitting · DN40 (1.5") · Aseptoflex Vario		
	Pipe fitting · Hygienic pipe fitting · Hygienic pipe fitting · DN40 (1.5") · DIN 11851 · for units with Aseptoflex Vario adapter · Sealing by sealing ring · Housing materials: stainless steel 316L / 1.4435	E33212
Hygienic pipe fitting · DN50 (2") · Aseptoflex Vario		
	Pipe fitting · Hygienic pipe fitting · Hygienic pipe fitting · DN50 (2") · DIN 11851 · for units with Aseptoflex Vario adapter · Sealing by sealing ring · Housing materials: stainless steel 316L / 1.4435	E33213
Hygienic pipe fitting · DN40 (1.5") · Aseptoflex Vario		
	Pipe fitting · Hygienic pipe fitting · Hygienic pipe fitting · DN40 (1.5") · DIN 11851 · for units with Aseptoflex Vario adapter · Metal to metal seal · Housing materials: stainless steel 316L / 1.4435	E33712
Hygienic pipe fitting · DN50 (2") · Aseptoflex Vario		
	Pipe fitting · Hygienic pipe fitting · Hygienic pipe fitting · DN50 (2") · DIN 11851 · for units with Aseptoflex Vario adapter · Metal to metal seal · Housing materials: stainless steel 316L / 1.4435	E33713
Varivent Adapter · Type N, DN40...DN150 (1.5...6"), D = 68 · Aseptoflex Vario		
	Clamp adapter · Varivent Adapter · Varivent type N · DN40...DN150 (1.5...6"), D = 68 · for units with Aseptoflex Vario adapter · Sealing by sealing ring · Housing materials: stainless steel 316L / 1.4435	E33222
	Clamp adapter · Varivent Adapter · Varivent type N · DN40...DN150 (1.5...6"), D = 68 · for units with Aseptoflex Vario adapter · Metal to metal seal · Housing materials: stainless steel 316L / 1.4435	E33722
SMS pipe fitting · DN40 (1.5") · Aseptoflex Vario		
	Pipe fitting · SMS pipe fitting · DN40 (1.5") · SMS · for units with Aseptoflex Vario adapter · Metal to metal seal · Housing materials: stainless steel 316L / 1.4435	E33731

Type	Description	Order no.
SMS pipe fitting · DN50 (2") · Aseptoflex Vario		
	Pipe fitting · SMS pipe fitting · DN50 (2") · SMS · for units with Aseptoflex Vario adapter · Metal to metal seal · Housing materials: stainless steel 316L / 1.4435	E33732
Welding adapter · D50 · Aseptoflex Vario		
	Welding adapter · Ø 50 mm · for units with Aseptoflex Vario adapter · Sealing by sealing ring · Housing materials: stainless steel 316L / 1.4435	E30122
Aseptoflex Vario · Aseptoflex Vario		
	sealing plug · Aseptoflex Vario · Housing materials: adapter: stainless steel 316L / 1.4435 / sealing ring: FKM	E30128
Clamp adapter · 1-1.5" · G ½		
	Clamp adapter · Clamp · 1-1.5" · ISO 2852 / DIN 32676 · for units with G ½ adaptation · Housing materials: stainless steel 316L / 1.4404	E33401
Clamp adapter · 2" · G ½		
	Clamp adapter · Clamp · 2" · ISO 2852 / DIN 32676 · for units with G ½ adaptation · Housing materials: stainless steel 316L / 1.4404	E33402
SMS pipe fitting · DN25 · G ½		
	Pipe fitting · SMS pipe fitting · DN25 · SMS · for units with G ½ adaptation · Housing materials: stainless steel 316L / 1.4404	E33430
Welding adapter · D30 · G ½		
	Welding adapter · G ½ · Ø 30 mm · for tanks · Housing materials: stainless steel 316L / 1.4435	E43300
Welding adapter · D29 · G ½		
	Welding adapter · G ½ · Ø 29 mm · for pipes · Housing materials: stainless steel 316L / 1.4435	E43301
Hygienic pipe fitting · DN25 (1") · G ½		
	Pipe fitting · G ½ · Hygienic pipe fitting · DN25 (1") · DIN 11851 · Housing materials: stainless steel 316L / 1.4435	E43304
Hygienic pipe fitting · DN40 (1.5") · G ½		
	Pipe fitting · G ½ · Hygienic pipe fitting · DN40 (1.5") · DIN 11851 · Housing materials: stainless steel 316L / 1.4435	E43305

Type	Description	Order no.
Varivent Adapter · Type F, DN25 (1"), D = 50 · G ½		
	Clamp adapter · G ½ · Varivent type F · DN25 (1"), D = 50 · Housing materials: stainless steel 316L / 1.4435	E43306
Varivent Adapter · Type N, DN40...DN150 (1.5...6"), D = 68 · G ½		
	Clamp adapter · G ½ · Varivent type N · DN40...DN150 (1.5...6"), D = 68 · Housing materials: stainless steel 316L / 1.4435	E43307
sealing plug · G ½		
	sealing plug · G ½ · Housing materials: stainless steel 316L / 1.4435	E43308
Welding adapter ball · D35 · G ½		
	Welding adapter · G ½ - Ø 35 mm · Housing materials: stainless steel 316L / 1.4404	E30055
Welding adapter collar · D45 · G ½		
	Welding adapter · G ½ - Ø 45 mm · Housing materials: stainless steel 316L / 1.4404	E30056
Welding adapter · D30 · G ½		
	Welding adapter · G ½ - Ø 30 mm · for tanks · with leakage port · with leakage port · Housing materials: stainless steel 316L / 1.4435	E43309
Welding adapter · D29 · G ½		
	Welding adapter · G ½ - Ø 29 mm · for pipes · with leakage port · with leakage port · Housing materials: stainless steel 316L / 1.4435	E43310
Clamp adapter · 1-1.5" · G ½		
	Clamp adapter · G ½ · with leakage port · Clamp · 1-1.5" · ISO 2852 / DIN 32676 · with leakage port · Housing materials: stainless steel 316L / 1.4435	E43311
Clamp adapter · 2" · G ½		
	Clamp adapter · G ½ · with leakage port · Clamp · 2" · ISO 2852 / DIN 32676 · with leakage port · Housing materials: stainless steel 316L / 1.4435	E43312
	Welding mandrel · G ½ · carries away heat during welding · Housing materials: brass	E43314

Type	Description	Order no.
Welding adapter collar · D45 · G ½		
	Welding adapter · G ½ · with leakage port · Housing materials: stainless steel 316L / 1.4404	E43315
Welding adapter · D50 · G ½		
	Welding adapter · G ½ · long design for deeper installation · long design for deeper installation · Housing materials: stainless steel 316L / 1.4435	E43319

Wiring diagrams

Core colours

- BK black
- BN brown
- BU blue
- WH white
- GY grey

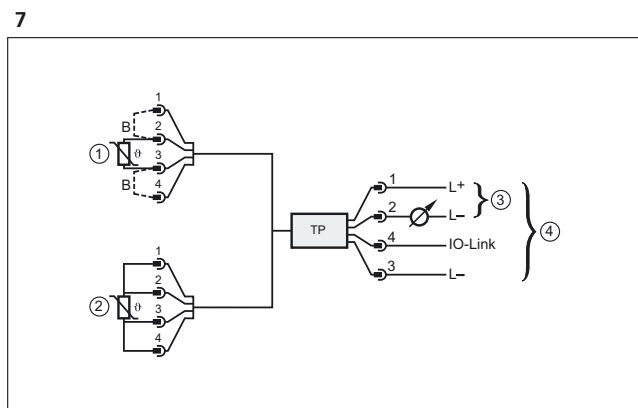
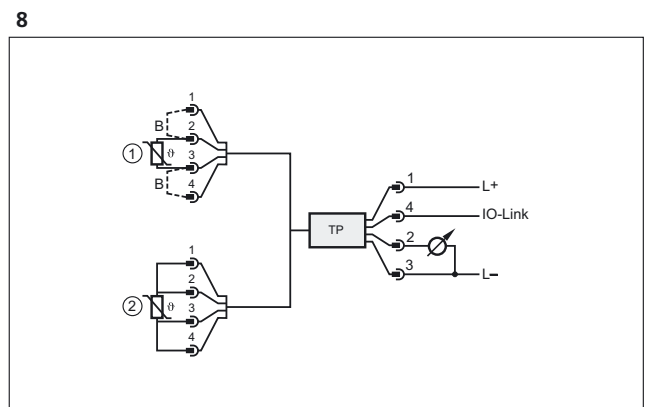
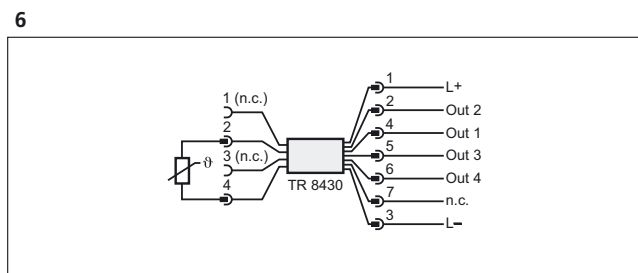
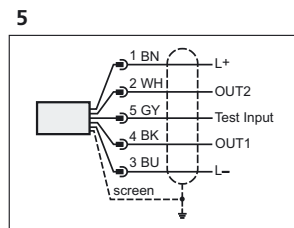
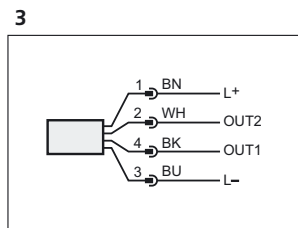
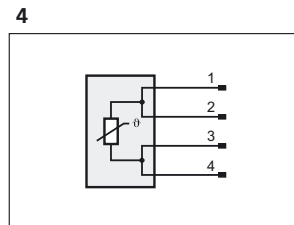
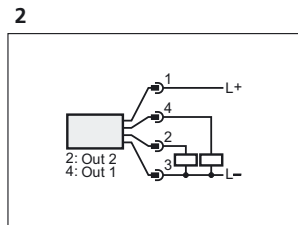
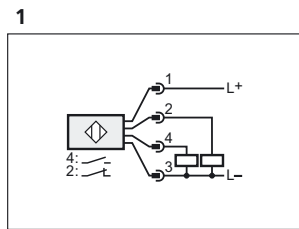

2: Two-wire sensor, 2: Four-wire sensor, B: link

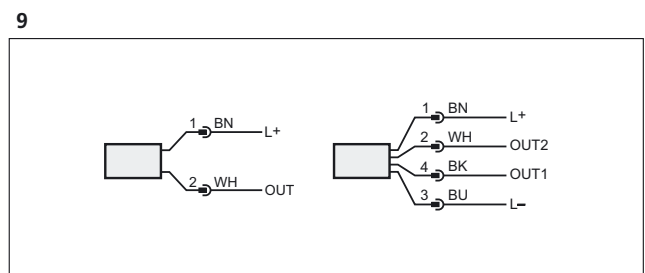

1: Two-wire sensor, 2: Four-wire sensor, 3: Operation as 2-wire temperature transmitter, 4: Operation as 3-wire unit, IO-Link communication possible, B: link

Wiring diagrams

10

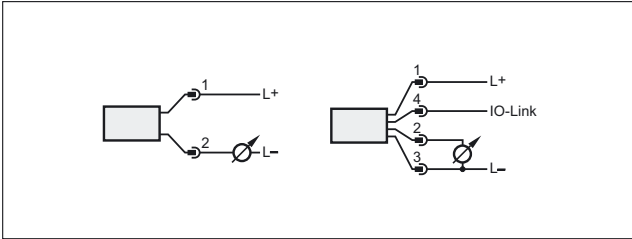

Scale drawings / drawing no. – CAD download: www.ifm.com

1

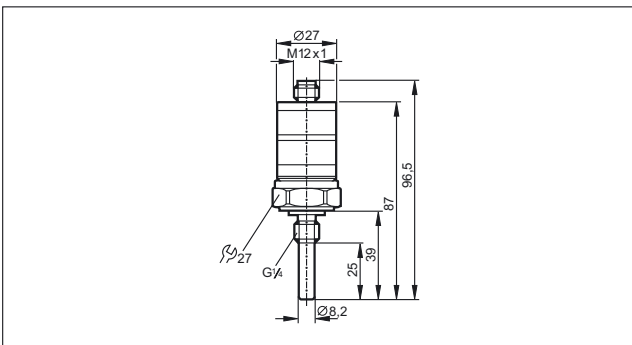

2

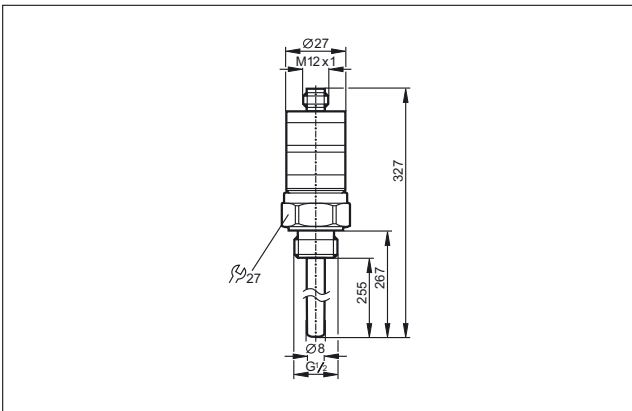

3

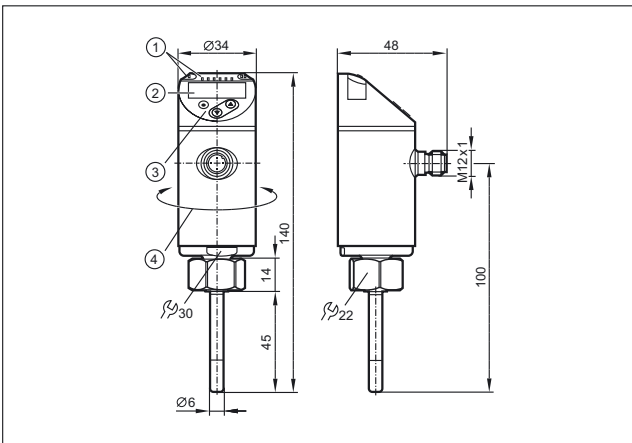

1: LEDs (display unit / switching status), 2: 4-digit alphanumeric display / alternating indication of red and green, 3: Programming buttons, 4: Upper part of the housing can be rotated by 345°

4

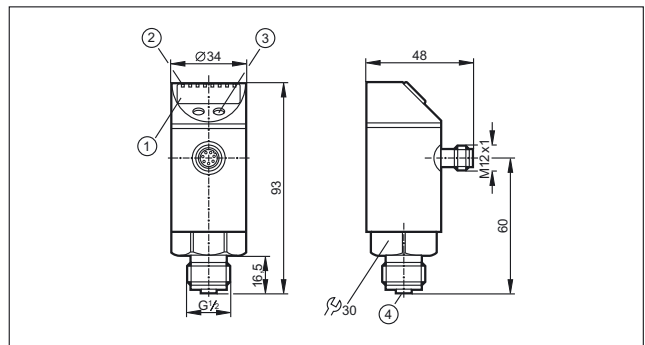

1: 4-digit alphanumeric display, 2: LEDs, 3: Programming button, 4: connector for temperature sensor (M12 x 1)

5

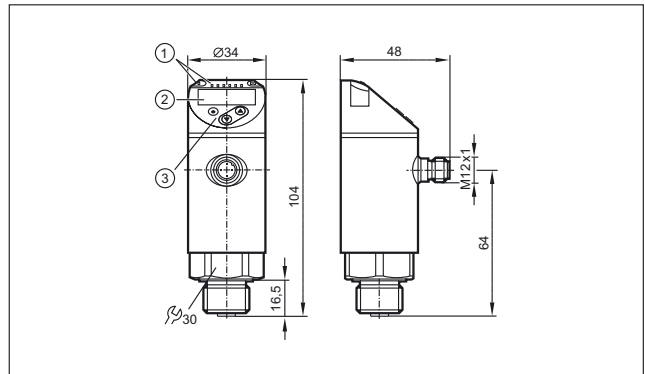

1: LEDs (display unit / switching status), 2: 4-digit alphanumeric display / alternating indication of red and green, 3: Programming buttons

6

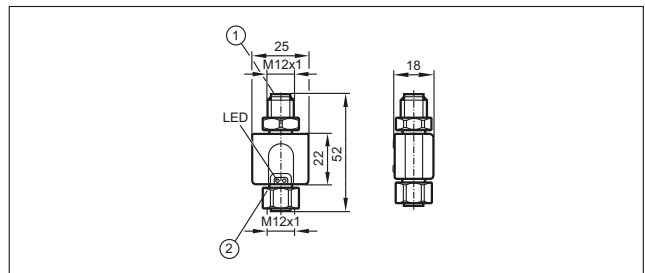

1: connection for voltage supply and output signals, 2: connection for temperature sensor

Scale drawings / drawing no. – CAD download: www.ifm.com

7

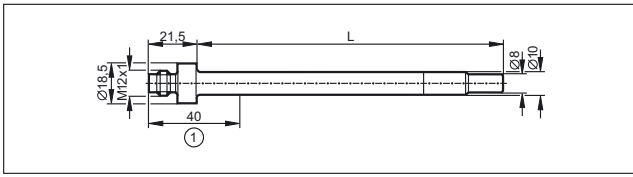

1: plug area, L = probe length (corresponds to installation length EL)

8

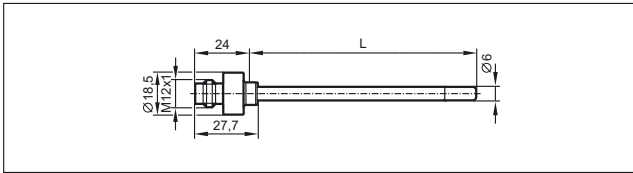

L = probe length (corresponds to installation length EL)

9

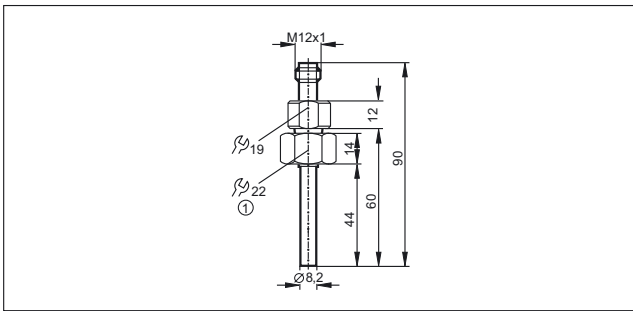

1: internal thread M18 x 1.5

10

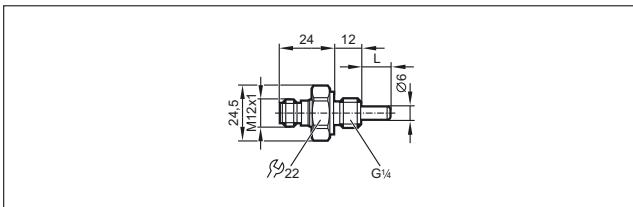

11

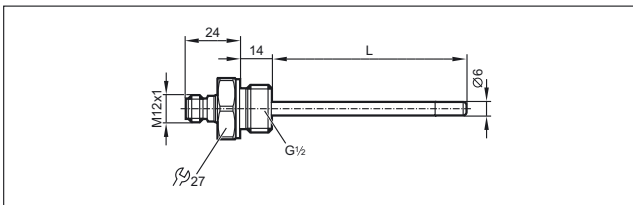

12

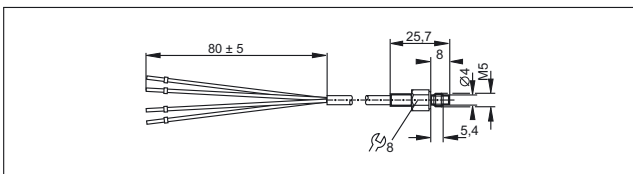

13

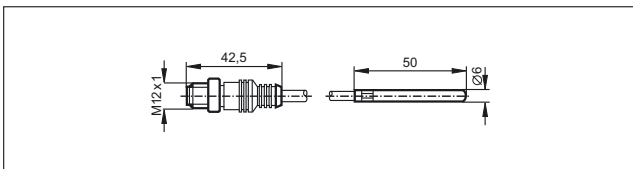

14

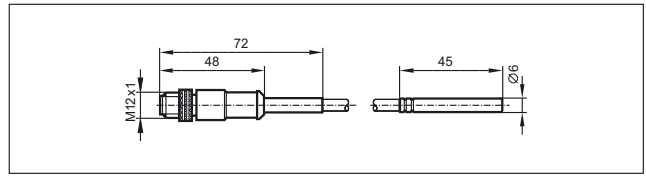

15

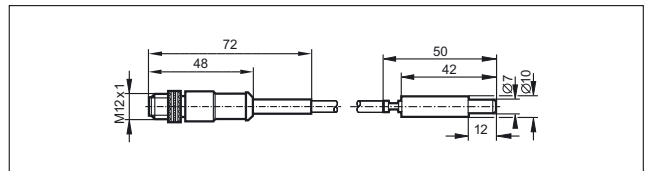

16

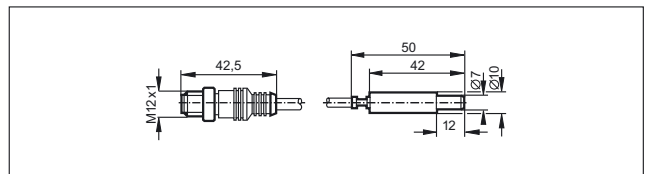

17

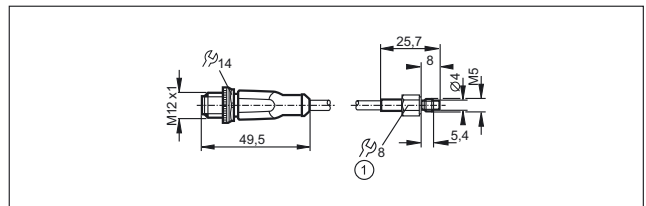

1: tightening torque 1.5 Nm

18

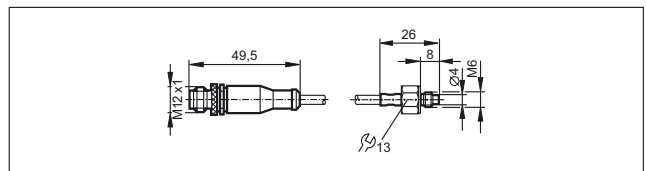

19

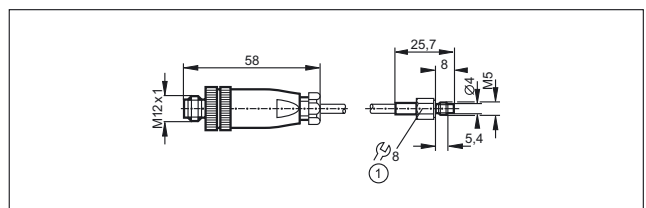

1: tightening torque 1.5 Nm

20

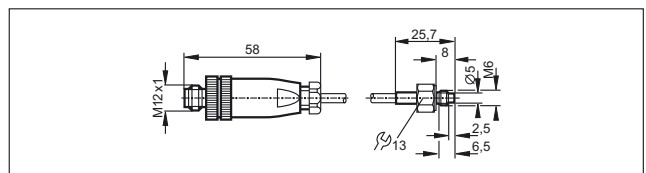

Scale drawings / drawing no. – CAD download: www.ifm.com

21

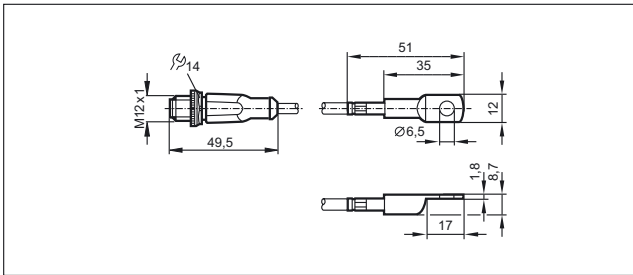

22

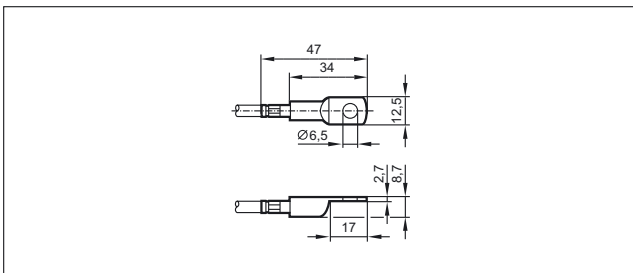

23

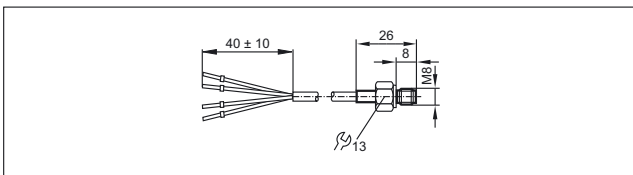

24

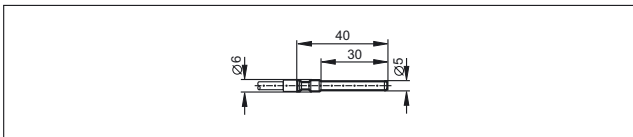

25

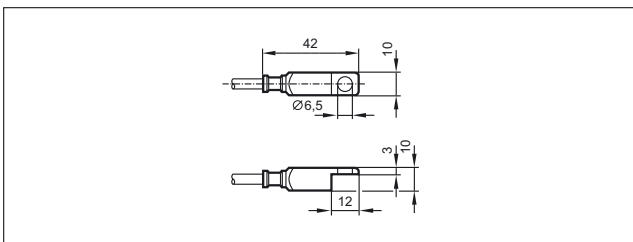

26

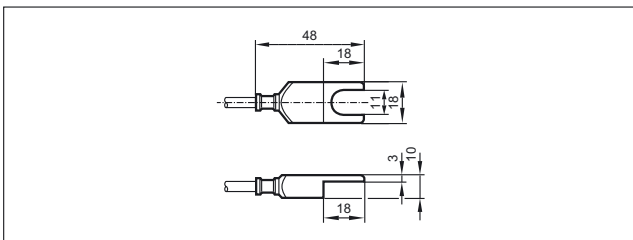

27

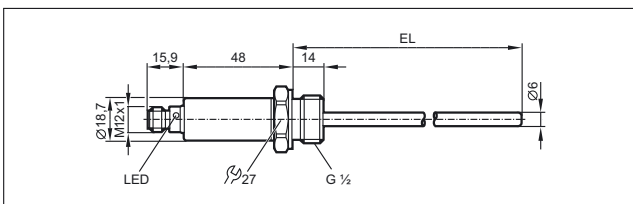

28

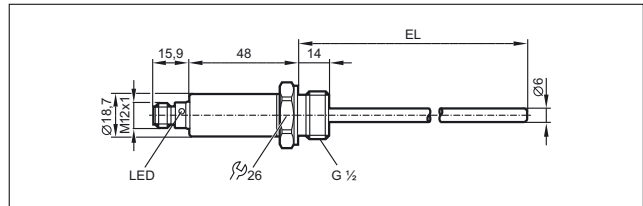

29

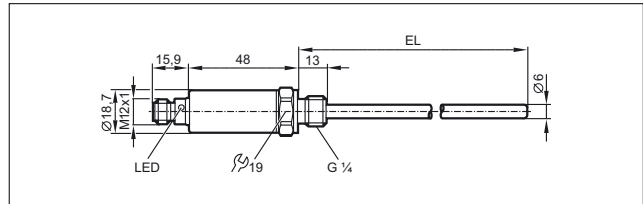

30

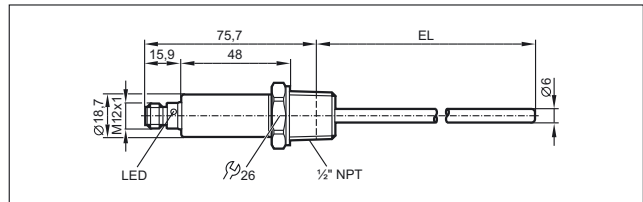

31

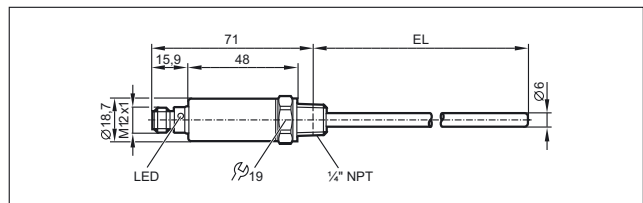

32

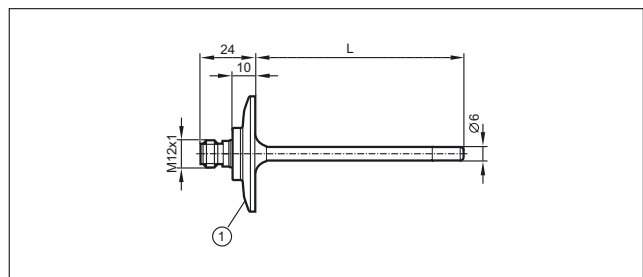

1: 1.5" clamp (ISO 2852), L = probe length (corresponds to installation length EL)

33

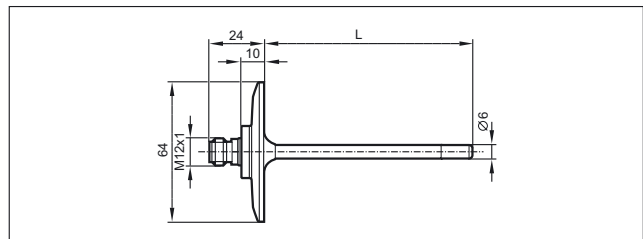

L = probe length (corresponds to installation length EL)

Scale drawings / drawing no. – CAD download: www.ifm.com

34

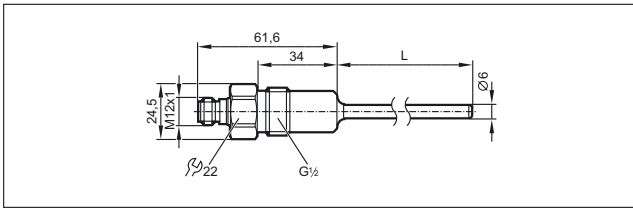

L = probe length (corresponds to installation length EL)

35

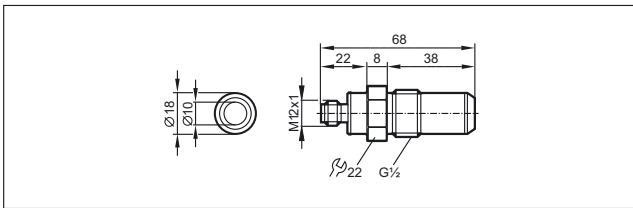

36

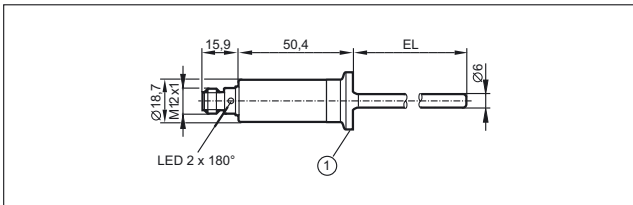

3/4" clamp (ISO 2852)

37

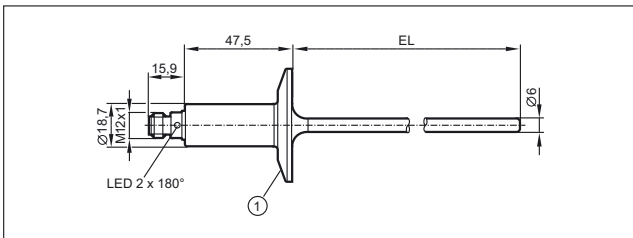

38

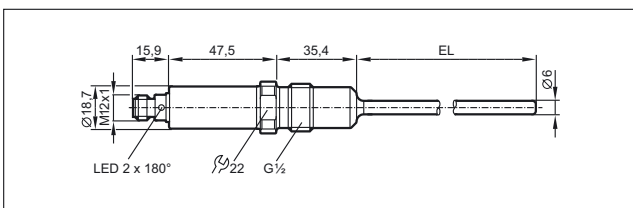

39

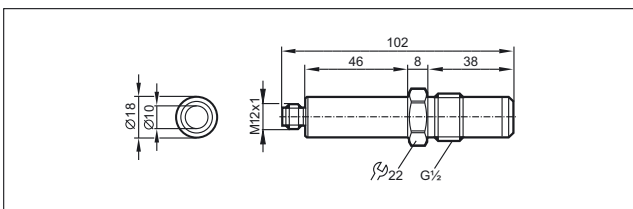

40

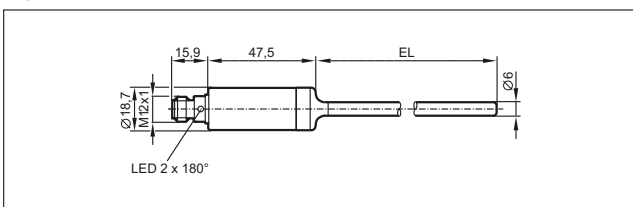

41

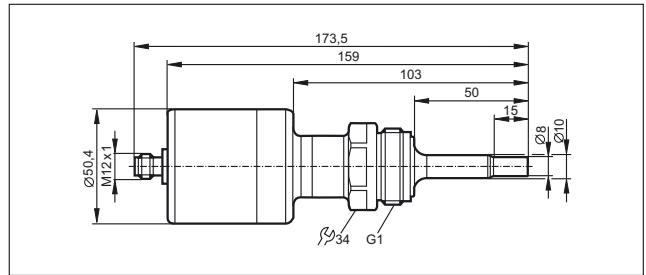

42

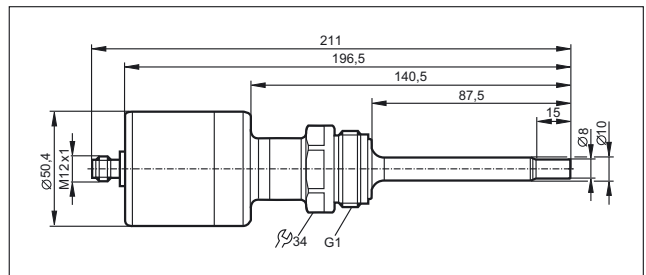

43

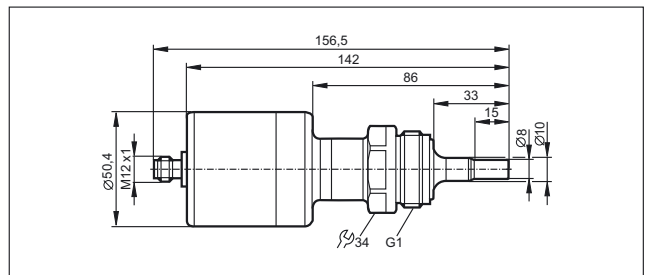

44

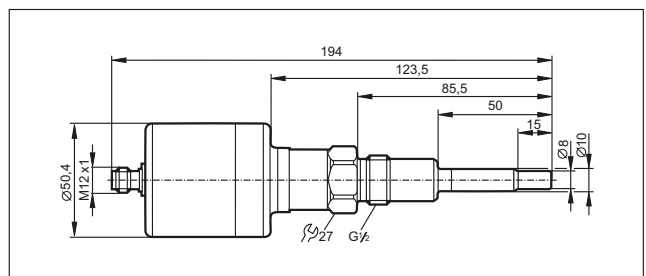

45

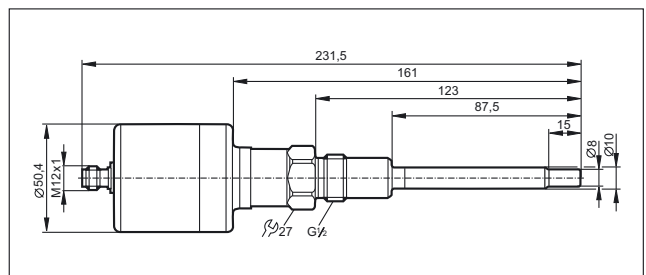

Product selectors and further information can be found at: www.ifm.com

Scale drawings / drawing no. – CAD download: www.ifm.com

46

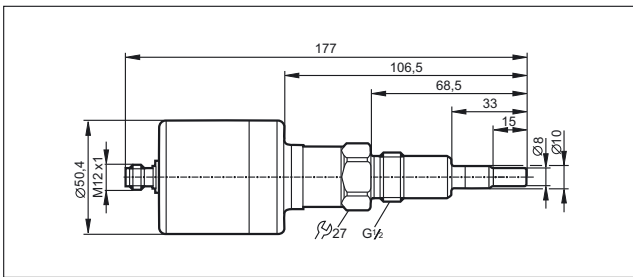

47

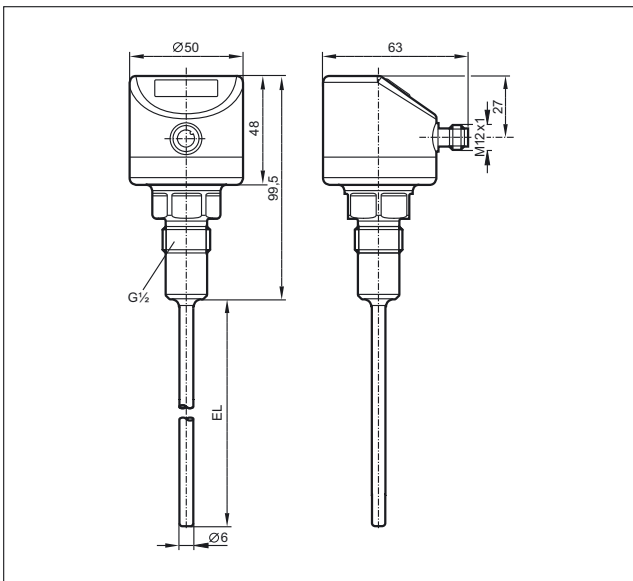

EL = Installation length

48

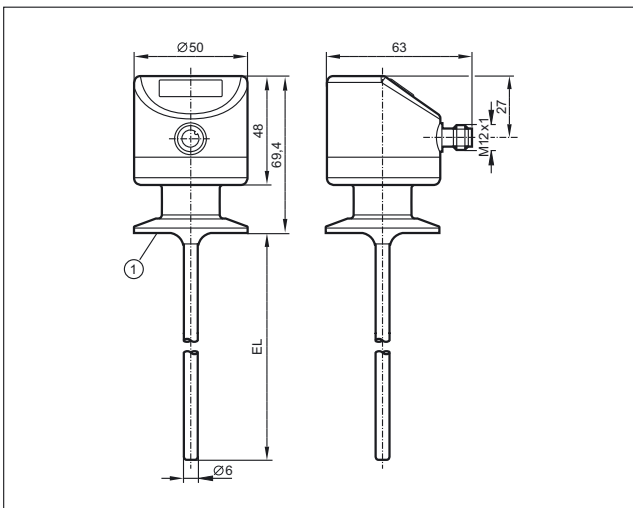

1: 1.5" clamp (ISO 2852), EL = Installation length

49

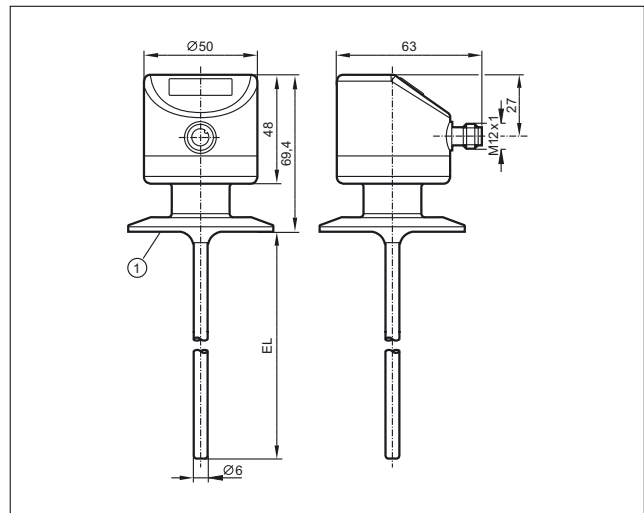

1: 2" clamp (ISO 2852), EL = Installation length

50

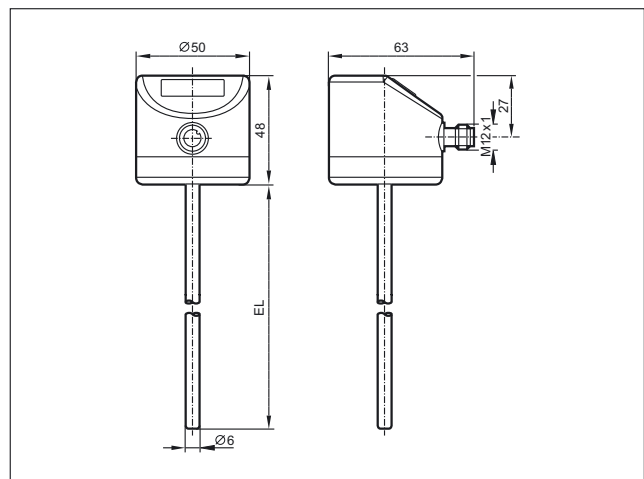

EL = Installation length

51

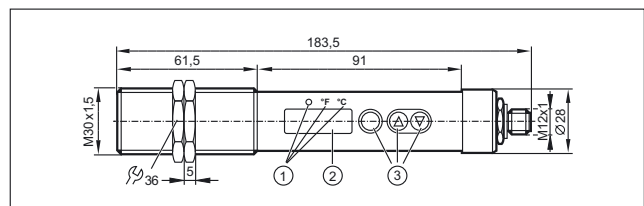

1: LEDs (display unit / switching status), 2: 7-segment LED display (4 digits), 3: Programming buttons

52

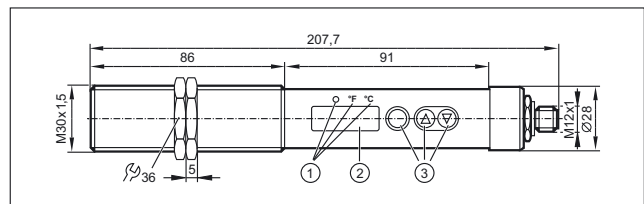

1: LEDs (display unit / switching status), 2: 7-segment LED display (4 digits), 3: Programming buttons

Scale drawings / drawing no. – CAD download: www.ifm.com

53

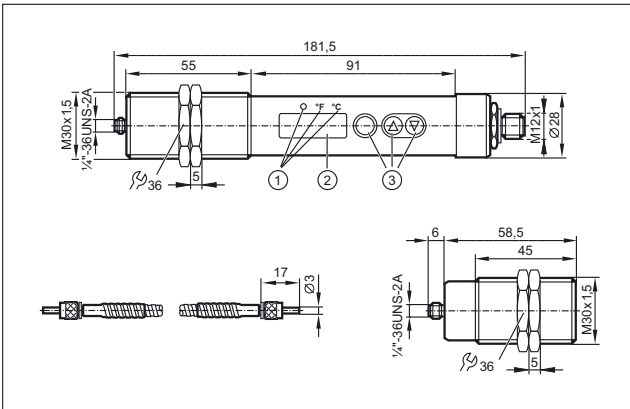

1: LEDs (display unit / switching status), 2: 7-segment LED display (4 digits), 3: Programming buttons

54

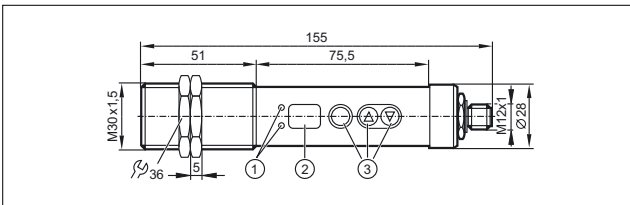

1: Programming buttons, 2: 7-segment LED display

55

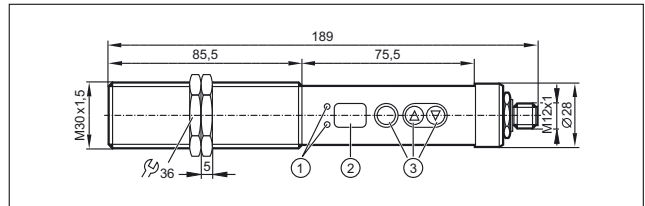

1: LEDs (switching status), 2: 7-segment LED display (2 digits), 3: Programming buttons

56

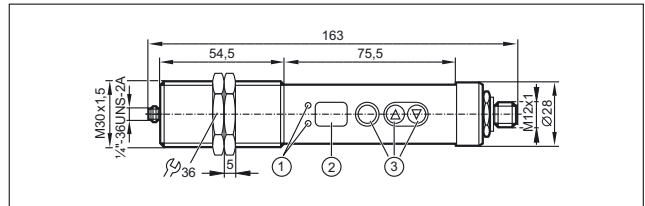

1: LEDs (switching status), 2: 7-segment LED display (2 digits), 3: Programming buttons





- **Integrated flow, temperature and wire-break monitoring**
- **Adjustable switch points for flow and temperature**
- **Multicolour LED bar graph display for quick setting**
- **Signal output using potential-free relay contacts (changeover contacts)**
- **Connection options: Insulation displacement / screw terminals and cage clamps**

Evaluation systems for flow sensors

Various evaluation systems are offered for flow sensors types SF/SP. The VS3000 series ensures high functionality in a space-saving housing for control cabinet mounting. A multi-coloured LED bar graph indicates the flow. Moreover it is signalled via LEDs and relay outputs when an adjustable medium temperature has been reached or if there is a possible wire break from the sensor to the electronics. The operating elements are located on the front. The evaluation systems are available both for AC and for DC supply voltage.

Sensors and control monitors are designed and approved for use in hazardous areas for applications in potentially explosive atmospheres. Wire monitoring between sensor and evaluation system as well as medium-temperature monitoring with optical display and signalling via potential-free relay outputs are also standard here.

The evaluation systems for local mounting are connected directly at the measuring point with the flow sensor via M12 connectors. The units are set via pushbutton with feedback via the LED bar-graph display. Electronic locking of the setting values and the possibility to reset the parameters to the factory setting provide additional safety.



Evaluation system for control cabinet mounting.

Evaluation system for local mounting.



System overview	Page
Control monitors for industrial applications	566
Control monitors with ATEX approval	566 - 567
Control monitors with ATEX approval 2G	567
Accessories	567
Wiring diagrams	567 - 568
Scale drawings / drawing no. – CAD download: www.ifm.com	569

Control monitors for industrial applications

Type	U _b / Tolerance [V] / [%]	Current consumpt. [mA]	Power consumpt. [VA]	Power-on delay time [s]	Output when flow is present	Output when temperature is exceeded	Output in case of wire break	Drawing no.	Order no.
Combicon connector · Wiring diagram no. 3									
	90...240 AC / -5 / +10	–	4	10...80	relay energised	relay energised	relay de-energised	1	SN0150*
Combicon connector · Wiring diagram no. 4									
	90...240 AC / -5 / +10	–	4	10...80	relay energised	–	relay de-energised	1	SN0151*
Combicon connector · Wiring diagram no. 5									
	24 DC / +10 / -20	90	–	10...80	relay energised	relay energised	relay de-energised	1	SR0150*
Combicon connector · Wiring diagram no. 6									
	24 DC / +10 / -10	90	–	10...80	relay energised	–	relay de-energised	1	SR0153*
M12 connector · Wiring diagram no. 1 · Connector groups 8, 10, 18, 20, 120, 124, 126, 128, 157									
	19...36 DC	70	–	10	no / nc programmable	–	–	2	SR5900
1/2" UNF-Connector · Wiring diagram no. 2 · Connector group 30									
	85...265 AC / -5 / +10	–	< 3.5	10	no / nc programmable	–	–	3	SR5906*

*** Note for AC and AC/DC units**

Miniature fuse to IEC60127-2 sheet 1, ≤ 5 A (fast acting) Recommendation: check the unit for reliable function after a short circuit.

Control monitors with ATEX approval

Type	U _b / Tolerance [V] / [%]	Current consumpt. [mA]	Power consumpt. [VA]	Power-on delay time [s]	Output when flow is present	Output when temperature is exceeded	Output in case of wire break	Drawing no.	Order no.
15 terminals...2.5 mm²									
	230 AC / ± 10	–	5	30	relay energised	–	relay de-energised	4	SN2301*
	110 AC / ± 10	–	5	30	relay energised	–	relay de-energised	4	SN2302*

Type	U _b / Tolerance [V] / [%]	Current consumpt. [mA]	Power consumpt. [VA]	Power-on delay time [s]	Output when flow is present	Output when temperature is exceeded	Output in case of wire break	Drawing no.	Order no.
------	--------------------------------------	------------------------	----------------------	-------------------------	-----------------------------	-------------------------------------	------------------------------	-------------	-----------

15 terminals...2.5 mm²

	24 DC / ± 10	125	–	30	relay energised	–	relay de-energised	4	SR2301*
---	--------------	-----	---	----	-----------------	---	--------------------	---	---------

*** Note for AC and AC/DC units**

Miniature fuse to IEC60127-2 sheet 1, ≤ 5 A (fast acting) Recommendation: check the unit for reliable function after a short circuit.

Control monitors with ATEX approval 2G

Type	U _b / Tolerance [V] / [%]	Current consumpt. [mA]	Power consumpt. [VA]	Power-on delay time [s]	Output when flow is present	Output when temperature is exceeded	Output in case of wire break	Drawing no.	Order no.
------	--------------------------------------	------------------------	----------------------	-------------------------	-----------------------------	-------------------------------------	------------------------------	-------------	-----------

15 terminals...2.5 mm² · Wiring diagram no. 7

	24 DC / ± 15	100	–	10	relay energised	–	–	5	SR307A*
--	--------------	-----	---	----	-----------------	---	---	---	---------

*** Note for AC and AC/DC units**

Miniature fuse to IEC60127-2 sheet 1, ≤ 5 A (fast acting) Recommendation: check the unit for reliable function after a short circuit.

Accessories

Type	Description	Order no.
------	-------------	-----------

	Combicon connector · with cage clamps 4 poles · Housing materials: current carrying parts: copper alloy tin-plated	E40171
---	--	--------

Wiring diagrams

Core colours

- BN brown
- BU blue
- BK black
- WH white
- GY grey

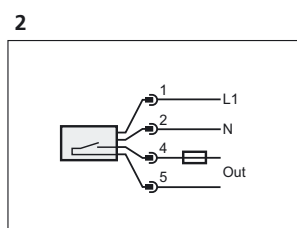
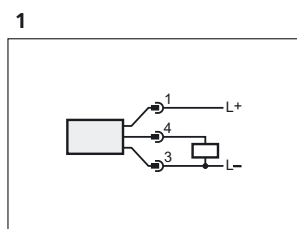

Wiring diagrams

3

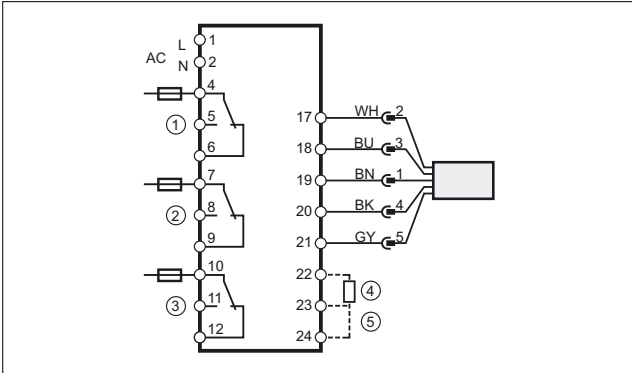

1: Flow monitoring, 2: Wire break monitoring, 3: Temperature monitoring, 4: Power-on delay time, 5: Selection liquid / gas

5

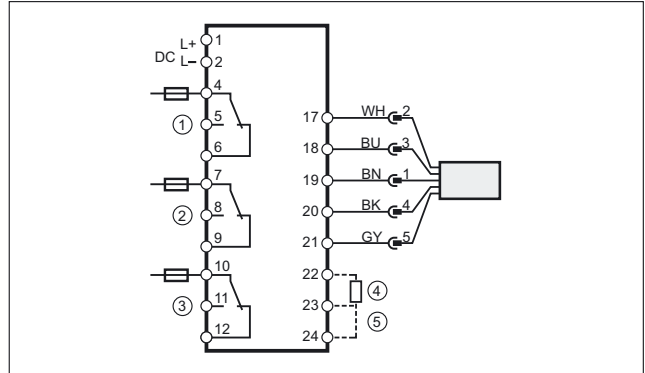

1: Flow monitoring, 2: Wire break monitoring, 3: Temperature monitoring, 4: Power-on delay time, 5: Selection liquid / gas

4

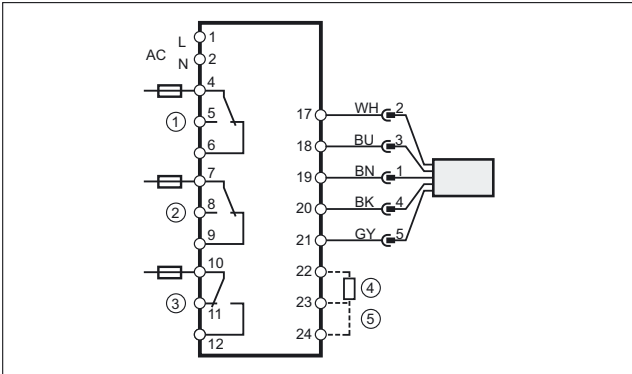

1: Flow monitoring, 2: Wire break monitoring, 3: Temperature monitoring, 4: Power-on delay time, 5: Selection liquid / gas, Note: miniature fuse to IEC60127-2 sheet 1,, ≤ 5 A (fast acting)

6

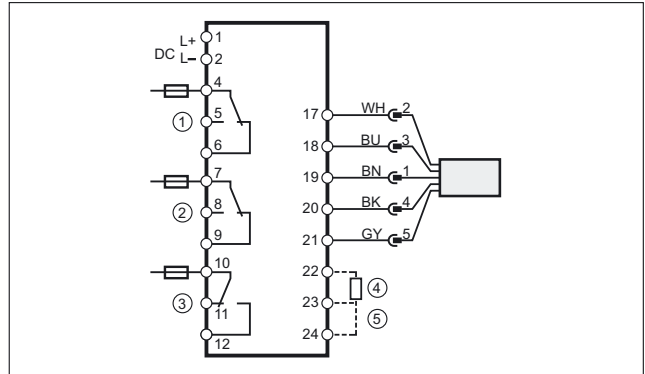

1: Flow monitoring, 2: Wire break monitoring, 3: Temperature monitoring, 4: Power-on delay time, 5: Selection liquid / gas, Note: miniature fuse to IEC60127-2 sheet 1,, ≤ 5 A (fast acting)

7

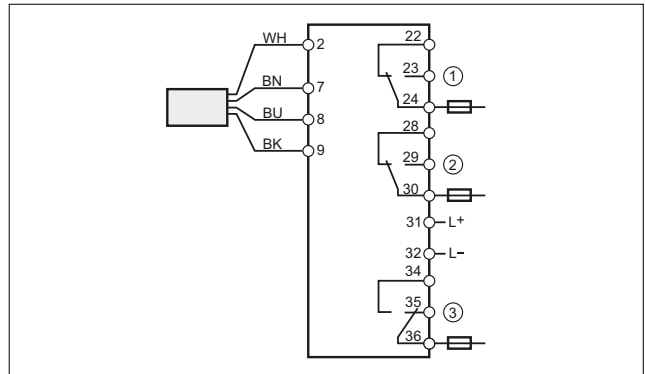

1: Flow monitoring, 2: Fault monitoring, 3: Temperature monitoring, Note: miniature fuse to IEC60127-2 sheet 1,, ≤ 5 A (fast acting), Place the fuse outside the hazardous area.

Scale drawings / drawing no. – CAD download: www.ifm.com

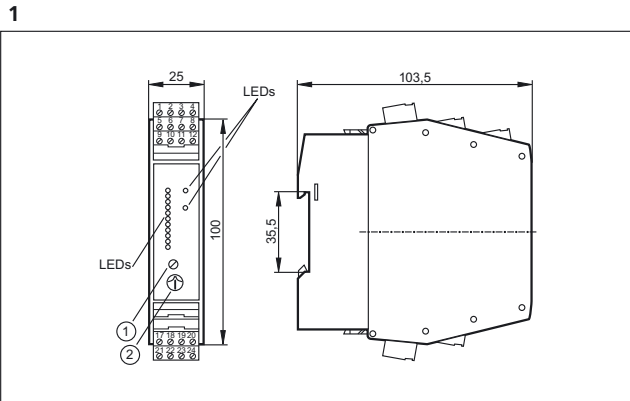

1: Potentiometer (switch point flow), 2: Potentiometer (switch point temperature)

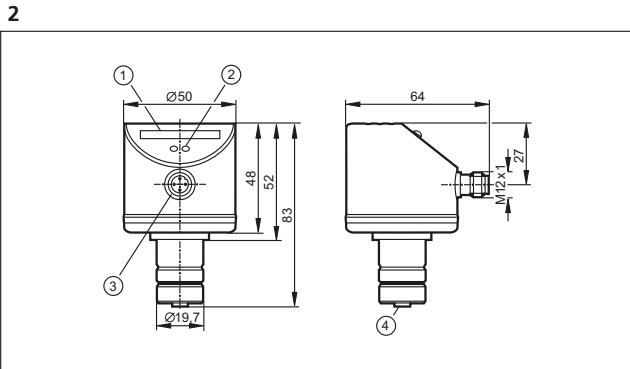

1: LED display, 2: setting pushbutton, 3: connection for voltage supply and output signals, 4: connection for flow sensor

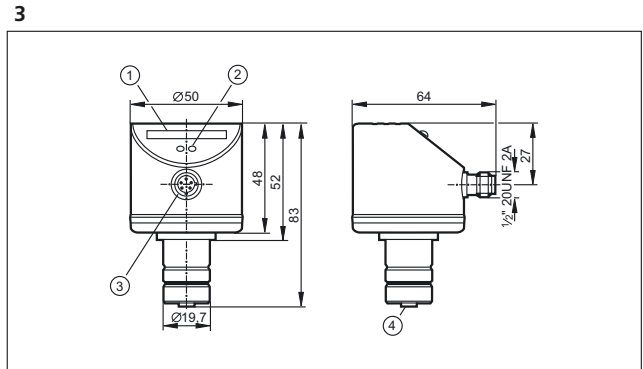

1: LED display, 2: setting pushbutton, 3: connection for voltage supply and output signals, 4: connection for flow sensor

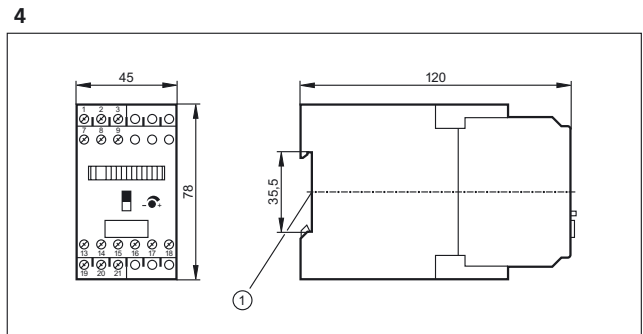

1: Mounting on DIN rail

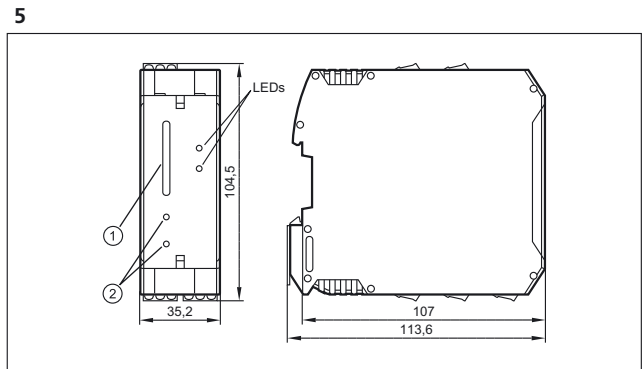

1: LED display, 2: setting pushbuttons



- Dual inductive feedback sensors for pneumatic actuators and valves
- Designed for simple fit to common actuators based on VDI / VDE 3845
- AS-i versions for even simpler and neater wiring
- Compact, weatherproof and low maintenance
- Mounting sets available for manual valves and non-standard actuators

Valve sensors

Butterfly and ball valves in a variety of specifications are common across a broad spectrum of industrial processes. A large proportion of these have been automated with the addition of a pneumatic actuator to drive the valve between its open and closed positions. Feedback can then be added to confirm that the valve has achieved its desired position. This often takes the form of a rotating cam arrangement with a couple of microswitches or small inductive sensors mounted inside a plastic switch box. Such switch boxes can be difficult to set up, suffer from ingress and the cams can sometimes slip under normal plant vibration.

Operating principle

In 1992 ifm electronic released our first alternative to this old and failure prone design. The IND dual sensor is essentially a pair of inductive sensors, operating at different frequencies so as not to interfere with each other, combined into a custom design housing which mechanically matches the top works on standard pneumatic actuators. The dual sensor fits neatly onto the actuator's existing M5 holes. A plastic target "puck" is then fitted onto the slotted actuator shaft, again using the existing threaded hole. The puck has two metal targets spaced 90 degrees apart which are picked up by either the OPEN sensor or the CLOSED sensor.

Advantages

This simple construction addresses all the shortcomings of the switchbox solution. It is weatherproof surviving heavy rain, ice and strong sunshine. It is low profile allowing valve / actuator packages to fit where a switchbox would not. This also means that feedback can be fitted to even small manually operated valves. It is low weight so will not fail even if pumps are causing pipe vibration. It allows for back wiring a local solenoid through the common multi-pin connector, saving on wiring and cable tray costs.







Feedback: Position monitoring of both pneumatically actuated and manual valves is needed for plant control.



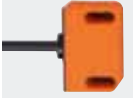
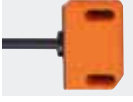

System overview	Page
Sensors for industrial applications	572 - 573
Sensors for industrial applications, AS-i system	573
Sensors with ATEX approval 1G / 2G and 1D	574
Sensors with ATEX approval 3D and / or 3G	575
Sensors for rising stem valves	575 - 576
Sensors for rising stem valves, AS-i system	576
Added value packages with Bürkert solenoid valve	576
Added value packages with Norgren Herion solenoid valve	576
Switching cams for sensors with quarter-turn actuators	577 - 578
Accessories for quarter-turn actuator sensors	578 - 579
Accessories for rising stem valve sensors	579
Wiring diagrams	580 - 581
Scale drawings / drawing no. – CAD download: www.ifm.com	581 - 583



Sensors for industrial applications

Type	Dimensions [mm]	Sensing range [mm]	Material	U _b [V]	Protection	f AC / DC [Hz]	I _{load} AC / DC [mA]	Drawing no.	Order no.
Cable 2 m · Output function  · AC/DC · Wiring diagram no. 1									
	40 x 26 x 40	4 nf	PBT	20...250	IP 67	25 / 50	250 / 100	1	IN0110*
Cable 2 m · Output function  · DC PNP · Wiring diagram no. 2									
	40 x 26 x 26	4 nf	PBT	10...36	IP 67	1300	250	2	IN5251
Cable 6 m · Output function  · DC PNP · Wiring diagram no. 2									
	40 x 26 x 26	4 nf	PC (polycarbonate)	10...36	IP 67	1300	250	2	IN5304
Cable 10 m · Output function  · DC PNP · Wiring diagram no. 2									
	40 x 26 x 26	4 nf	PBT	10...36	IP 67	1300	250	2	IN5323
M12 connector · Output function  · DC PNP/NPN · Wiring diagram no. 13 · Connector groups 8, 10, 18, 20, 120, 124, 126, 128, 157									
	40 x 26 x 26	4 nf	PBT	10...36	IP 67	1300	250	3	IN5224
M12 connector · Output function  · DC PNP/NPN · Wiring diagram no. 3 · Connector groups 8, 10, 18, 20, 120, 124, 126, 128, 157									
	40 x 26 x 47	4 nf	PBT	10...36	IP 67	250	250	4	IN5331
M12 connector · Output function  · DC PNP · Wiring diagram no. 4 · Connector groups 8, 9, 10, 11, 18, 20, 120, 124, 126, 128, 130, 131, 157, 158									
	40 x 26 x 26	4 nf	PBT	10...36	IP 67	1300	250	3	IN5225
	40 x 26 x 47	4 nf	PBT	10...36	IP 67	1300	250	4	IN5327
M18 connector · Output function  · DC PNP · Wiring diagram no. 4 · Connector group 24									
	40 x 26 x 26	4 nf	PBT	10...36	IP 67	1300	250	5	IN5285

Type	Dimensions [mm]	Sensing range [mm]	Material	U _b [V]	Protection	f AC / DC [Hz]	I _{load} AC / DC [mA]	Draw- ing no.	Order no.
------	--------------------	--------------------------	----------	-----------------------	------------	----------------------	--------------------------------------	---------------------	--------------

M18 connector · Output function  /  · AC/DC · Wiring diagram no. 5 · Connector group 24

	40 x 26 x 40	4 nf	PBT	20...250	IP 67	25 / 50	250 / 100	6	IN0108*
---	--------------	------	-----	----------	-------	---------	-----------	---	---------

Rd 24 x 1/8 connector 6 pins · Output function  /  · DC PNP · Connector groups 34, 40, 135, 136

	40 x 26 x 60	4 nf	PBT	10...36	IP 67	1300	250	7	IN5334
---	--------------	------	-----	---------	-------	------	-----	---	--------

Terminals · Output function  /  · DC PNP · Wiring diagram no. 14

	33 x 60 x 92	4 nf	PA (polyamide)	10...30	IP 67	500	100	8	IN5409
---	--------------	------	----------------	---------	-------	-----	-----	---	--------

f = flush / nf = non flush

*** Note for AC and AC/DC units**

Miniature fuse to IEC60127-2 sheet 1, ≤ 2 A (fast acting) Recommendation: check the unit for reliable function after a short circuit.

Sensors for industrial applications, AS-i system

Type	Dimensions [mm]	Sensing range [mm]	Material	U _b [V]	Protection	f AC / DC [Hz]	I _{load} AC / DC [mA]	Draw- ing no.	Order no.
------	--------------------	--------------------------	----------	-----------------------	------------	----------------------	--------------------------------------	---------------------	--------------

M12 connector · 1 x 2 inputs · Wiring diagram no. 6 · Connector groups 10, 12, 13, 18, 19, 20, 21, 120, 122, 124, 126, 128, 132, 157, 159

	55 x 60 x 35	4 nf	PBT (Pocan)	26.5...31.6	IP 67	–	–	9	AC2315
---	--------------	------	-------------	-------------	-------	---	---	---	--------

M12 connector · Output function transistor PNP · 2 inputs / 1 output · Connector groups 8, 10, 18, 20, 40, 120, 124, 126, 128, 135, 136, 157

	55 x 60 x 35	4 nf	PBT (Pocan)	26.5...31.6	IP 67	–	–	10	AC2316
---	--------------	------	-------------	-------------	-------	---	---	----	--------

M12 connector · Output function transistor PNP · 2 inputs / 2 outputs · Connector groups 8, 10, 18, 20, 40, 120, 124, 126, 128, 135, 136, 157

	55 x 60 x 35	4 nf	PBT (Pocan)	26.5...31.6	IP 67	–	–	10	AC2317
---	--------------	------	-------------	-------------	-------	---	---	----	--------

f = flush / nf = non flush

Sensors with ATEX approval 1G / 2G and 1D

Type	Dimensions [mm]	Sensing range [mm]	Material	U _{nom.} at 1 KΩ [V]	U _b [V]	Internal capacit. [nF]	Internal inductance [μH]	f [Hz]	Drawing no.	Order no.
------	--------------------	-----------------------	----------	-------------------------------------	-----------------------	---------------------------	-----------------------------	-----------	-------------	-----------

Cable 2 m · Output function 2 x normally closed · Connection to certified intrinsically safe circuits with the max. values U = 15 V / I = 50 mA / P = 120 mW · Wiring diagram no. 7

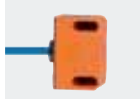
	40 x 26 x 26	4 nf	PBT	8.2 DC	7.5...15 DC	140	130	1800	2	NN5009
---	--------------	------	-----	--------	-------------	-----	-----	------	---	--------

Cable 10 m · Output function 2 x normally closed · Connection to certified intrinsically safe circuits with the max. values U = 15 V / I = 50 mA / P = 120 mW · Wiring diagram no. 7

	40 x 26 x 26	4 nf	PBT	8.2 DC	7.5...15 DC	140	140	1800	2	NN5011
---	--------------	------	-----	--------	-------------	-----	-----	------	---	--------

M12 connector · Output function 2 x normally closed · Connection to certified intrinsically safe circuits with the max. values U = 15 V / I = 50 mA / P = 120 mW · Wiring diagram no. 8 · Connector group 153

	40 x 26 x 26	4 nf	PBT	8.2 DC	7.5...15 DC	140	130	1800	11	NN5008
---	--------------	------	-----	--------	-------------	-----	-----	------	----	--------

M18 connector · Output function 2 x normally closed · Connection to certified intrinsically safe circuits with the max. values U = 15 V / I = 50 mA / P = 120 mW · Wiring diagram no. 9 · Connector group 24

	40 x 26 x 26	4 nf	PBT	8.2 DC	7.5...15 DC	140	130	1800	5	NN5013
---	--------------	------	-----	--------	-------------	-----	-----	------	---	--------

Rd 24 x 1/8 connector 6 pins · Output function 2 x normally closed · Connection to certified intrinsically safe circuits with the max. values U = 15 V / I = 50 mA / P = 120 mW · Connector groups 34, 56, 64, 107, 108, 109, 110, 111, 112, 137, 152

	40 x 26 x 60	4 nf	PBT	8.2 DC	–	150	150	250	7	N95001
	40 x 26 x 60	4 nf	PBT	8.2 DC	–	100	150	1300	7	N95002

Terminals · Output function 2 x normally closed · Connection to certified intrinsically safe circuits with the max. values U = 15 V / I = 50 mA / P = 120 mW · Wiring diagram no. 15

	33 x 60 x 92	4 nf	PA (polyamide)	8.2 DC	7.5...15 DC	–	–	500	8	NN504A
---	--------------	------	----------------	--------	-------------	---	---	-----	---	--------

Terminals · Output function 2 x normally closed · Connection to certified intrinsically safe circuits with the max. values U = 15 V / I = 50 mA / P = 120 mW · Wiring diagram no. 16 · Connector group --

	33 x 60 x 92	4 nf	PA (polyamide)	8.2 DC	7.5...15 DC	–	–	500	12	NN505A
---	--------------	------	----------------	--------	-------------	---	---	-----	----	--------

f = flush / nf = non flush

Sensors with ATEX approval 3D and / or 3G

Type	Dimensions [mm]	Sensing range [mm]	Material	U _b [V]	Protection	f AC / DC [Hz]	I _{load} AC / DC [mA]	Draw- ing no.	Order no.
------	--------------------	--------------------------	----------	-----------------------	------------	----------------------	--------------------------------------	---------------------	--------------

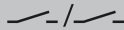
Cable 2 m · Output function  · DC PNP · Wiring diagram no. 2

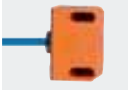
	40 x 26 x 26	4 nf	PBT (Pocan)	10...30	IP 67	1300	100	2	IN508A
---	--------------	------	-------------	---------	-------	------	-----	---	--------

M12 connector · Output function transistor PNP · 2 inputs / 2 outputs · Connector groups 154, 156

	55 x 60 x 35	4 nf	PBT (Pocan)	26.5...31.6	IP 5x	–	–	10	AC317A
---	--------------	------	-------------	-------------	-------	---	---	----	--------

M12 connector · Output function transistor PNP · 2 inputs / 1 output · Connector groups 154, 156

	55 x 60 x 35	4 nf	PBT (Pocan)	26.5...31.6	IP 5x	–	–	10	AC316A
---	--------------	------	-------------	-------------	-------	---	---	----	--------

	55 x 60 x 35	4	PBT (Pocan)	26.5...31.6	IP 67	–	–	13	AC326A
--	--------------	---	-------------	-------------	-------	---	---	----	--------

M12 connector · 1 x 2 inputs · Wiring diagram no. 6 · Connector groups 154, 156

	55 x 60 x 35	4 nf	PBT (Pocan)	26.5...31.6	IP 5x	–	–	9	AC315A
---	--------------	------	-------------	-------------	-------	---	---	---	--------

M12 connector · Output function  · DC PNP · Wiring diagram no. 4 · Connector groups 154, 156

	40 x 26 x 47	4	PBT	10...30	IP 67	1300	100	14	IN507A
---	--------------	---	-----	---------	-------	------	-----	----	--------

	40 x 26 x 47	4 nf	PBT (Pocan)	10...30	IP 67	1300	100	4	IN509A
---	--------------	------	-------------	---------	-------	------	-----	---	--------

f = flush / nf = non flush

Sensors for rising stem valves

Type	Dimensions [mm]	Sensing range [mm]	Material	U _b [V]	Protection	f AC / DC [Hz]	I _{load} AC / DC [mA]	Draw- ing no.	Order no.
------	--------------------	--------------------------	----------	-----------------------	------------	----------------------	--------------------------------------	---------------------	--------------

Cable 2 m · Output function 1...5 V analogue · DC · Wiring diagram no. 10



	67.5 x 43 x 110	–	PA	18...36	IP 65 / IP 67	–	–	15	IX5002
---	-----------------	---	----	---------	---------------	---	---	----	--------

Cable 2 m · Output function 3 x normally open · DC PNP · Wiring diagram no. 11

	67.5 x 43 x 110	–	PA	18...36	IP 65 / IP 67	–	100	16	IX5006
---	-----------------	---	----	---------	---------------	---	-----	----	--------

You can find wiring diagrams and scale drawings from page 580

Process sensors

Type	Dimensions [mm]	Sensing range [mm]	Material	U _b [V]	Protection	f AC / DC [Hz]	I _{load} AC / DC [mA]	Draw- ing no.	Order no.
Cable with connector 0.3 m · Output function 3 x normally open · DC PNP · Wiring diagram no. 12 · Connector groups 122, 126, 128, 132, 159									
	65 x 52 x 110	–	PA	18...36	IP 65 / IP 67	–	100	17	IX5010
	65 x 43 x 110	0.2	PA	18...36	IP 65 / IP 67	–	100	18	ZZ0214

Sensors for rising stem valves, AS-i system

Type	Dimensions [mm]	Sensing range [mm]	Material	U _b [V]	Protection	f AC / DC [Hz]	I _{load} AC / DC [mA]	Draw- ing no.	Order no.
Cable with connector 0.15 m · AS-i · Wiring diagram no. 6 · Connector groups 10, 12, 13, 18, 19, 20, 21, 120, 122, 124, 126, 128, 132, 157, 159									
	65 x 52 x 110	–	PA	26.5...31.6	IP 65 / IP 67	–	–	17	IX5030













Added value packages with Bürkert solenoid valve

Type	Description	Order no.
	Added value package AS-i for pneumatic quarter-turn actuators · A/B slave · Shaft height 20 mm · Hole spacing 80 mm · Connector	AC0017
	Added value package AS-i for pneumatic quarter-turn actuators · A/B slave · Shaft height 30 mm · Hole spacing 80 mm · Connector	AC0019
	Added value package AS-i for pneumatic quarter-turn actuators · A/B slave · Shaft height 30 mm · Hole spacing 130 mm · Connector	AC0020

Added value packages with Norgren Herion solenoid valve



Type	Description	Order no.
	Added value package AS-i for pneumatic quarter-turn actuators · A/B slave · Shaft height 20 mm · Hole spacing 80 mm · Connector	AC0021
	Added value package AS-i for pneumatic quarter-turn actuators · A/B slave · Shaft height 30 mm · Hole spacing 80 mm · Connector	AC0022
	Added value package AS-i for pneumatic quarter-turn actuators · A/B slave · Shaft height 30 mm · Hole spacing 130 mm · Connector	AC0023





Switching cams for sensors with quarter-turn actuators

Type	Description	Order no.
	Target puck · Ø 53 mm · The upper damping level is 360° continuously adjustable · Housing materials: Target puck: PVC / screws: high-grade stainless steel	E10661
	Target puck · Ø 53 mm · 6 possible switching flag positions · with drain holes · Housing materials: Target puck: PA 6 / screws: high-grade stainless steel	E17105
	Target puck · Ø 53 mm · Housing materials: Target puck: PBT / screws: high-grade stainless steel	E17118
	Target puck · Ø 53 mm · 8 possible switching flag positions · with drain holes · Housing materials: Target puck: PA 6 / screws: high-grade stainless steel	E17294
	Target puck · Ø 53 mm · 3 possible switching flag positions · Housing materials: Target puck: PA 6 black / screws: V2A	E17320
	Target puck · Ø 53 mm · 8 possible switching flag positions · Housing materials: Target puck: PA 6 black / screws: V2A	E17321
	Target puck · Ø 53 mm · Housing colour: blue · 8 possible switching flag positions · Housing materials: Target puck: PA 6 blue / screws: V2A	E17322
	Target puck · Ø 53 mm · Housing colour: red · 8 possible switching flag positions · Housing materials: Target puck: PA 6 / screws: V2A	E17323
	Target puck · Ø 55 mm · Inverted function · Housing materials: Target puck: PVC / screws: high-grade stainless steel / Metal ring: stainless steel	E17205
	Target puck · Ø 59 mm · for Neles actuator type B1CU 6/20E · Housing materials: Target puck: POM	E11278
	Target puck · Ø 65 mm · Housing materials: Target puck: PVC / screws: high-grade stainless steel	E17148
	Target puck · Ø 65 mm · Housing colour: black · 8 possible switching flag positions · Housing materials: Target puck: PA 6 / screws: V2A	E17324
	Target puck · Ø 65 mm · Housing colour: blue · 8 possible switching flag positions · Housing materials: Target puck: PA 6 / screws: V2A	E17325
	Target puck · Ø 65 mm · Housing colour: red · 8 possible switching flag positions · Housing materials: Target puck: PA 6 / screws: V2A	E17326

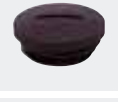
Type	Description	Order no.
	Target puck · Ø 65 mm · Housing materials: Target puck: PA 6 / screws: V2A	E17327
	Target puck · Ø 102 mm · Housing materials: Target puck: PA 6 / screws: V2A	E17328
	Target puck · Ø 102 mm · Housing colour: black · 8 possible switching flag positions · Housing materials: Target puck: PA 6 / screws: V2A	E17329
	Target puck · Ø 102 mm · Housing colour: blue · 8 possible switching flag positions · Housing materials: Target puck: PA 6 / screws: V2A	E17330
	Target puck · Ø 102 mm · Housing colour: red · 8 possible switching flag positions · Housing materials: Target puck: PA 6 / screws: V2A	E17331
	direction indicator black · 12 x 4.8 · For target puck · Housing materials: POM	E17295
	direction indicator yellow · 12 x 4.8 · For target puck · Housing materials: POM	E17296

Accessories for quarter-turn actuator sensors

Type	Description	Order no.
	Spacer · 10 mm · for compensation between target pucks and dual sensor IND · Housing materials: PBT	E10579
	Spacer · 3 mm · for compensation between target pucks and dual sensor IND · Housing materials: PBT	E10584
	Spacer · 5 mm · for compensation between target pucks and dual sensor IND · Housing materials: PBT	E10585
	Cable gland · M20 x 1.5 · Housing materials: PA 6.6	E12208
	Protective cap · M20 x 1.5 · Housing materials: PA 6.6	E12209
	Plug for covering the oblong holes · Housing materials: EPDM	E12212

Type	Description	Order no.
	reinforcement bracket · for type IND · Housing materials: stainless steel 316Ti / 1.4571	E11310
	protective housing · Accessory for valve sensors · for type IND · Housing materials: stainless steel	E11984
	Mounting kit · MS-MEC-KU-RA--F04A · for ball valve Mecafrance ISO5211/F04 DN25 PN40 · Detection of the "ON/OFF" position by means of the IND dual sensor	E10597
	Mounting kit for limit position feedback · tyco 792E-100 · for Keystone actuators	E11243

Accessories for rising stem valve sensors

Type	Description	Order no.
	Mounting adapter · for Kieselmann seat valves · accessory for IX5010, IX5030 · Housing materials: adapter: PA / target: stainless steel 316L / 1.4404	E12123
	Mounting adapter · for Alfa Laval valves · accessory for IX5010, IX5030 · Housing materials: adapter: PA / target: stainless steel 316L / 1.4404	E11900
	Mounting adapter · for Südmo valves · accessory for IX5010, IX5030 · Housing materials: adapter: PA / target: stainless steel 316L / 1.4404	E11989
	Mounting adapter · for Georg Fischer diaphragm valve Diastar with mounting kit M12 · accessory for IX5010, IX5030 · Housing materials: adapter: POM / target: stainless steel	E12009
	Mounting adapter · for Georg Fischer diaphragm valve Diastar with mounting kit M16 · accessory for IX5010, IX5030 · Housing materials: adapter: POM / target: stainless steel	E12010
	Mounting adapter · for Bardiani valves · accessory for IX5010, IX5030 · Housing materials: adapter: PA / target: stainless steel 316L / 1.4404	E12170
	Mounting adapter · IX / Ø 30 mm · for Gemü actuators with mounting kit · accessory for IX5010, IX5030 · Housing materials: adapter: POM / target: stainless steel	E12042
	Mounting adapter · IX / Ø 45 mm · for Gemü actuators with mounting kit · accessory for IX5010, IX5030 · Housing materials: adapter: POM / target: stainless steel	E12043

Wiring diagrams

Core colours

BN	brown
BU	blue
BK	black
WH	white
GY	grey

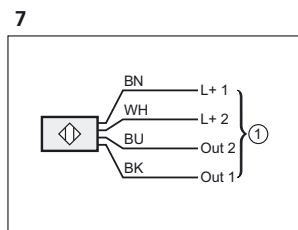
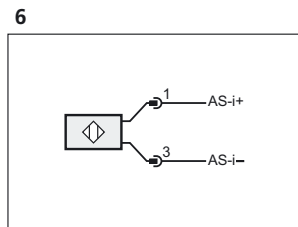
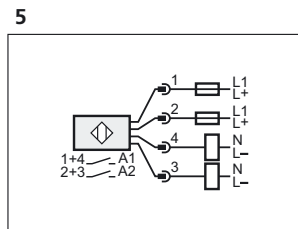
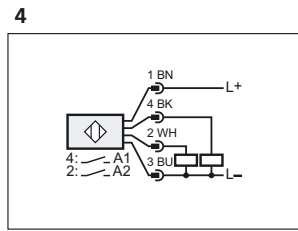
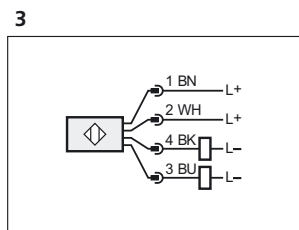
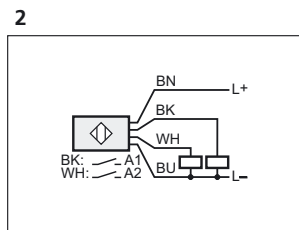
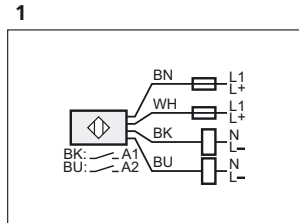

1: connection to NAMUR-amplifier

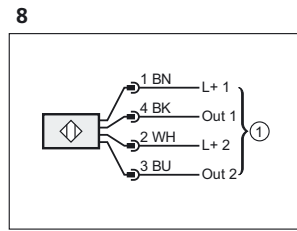

1: connection to NAMUR-amplifier

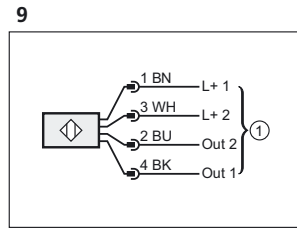

1: connection to NAMUR-amplifier

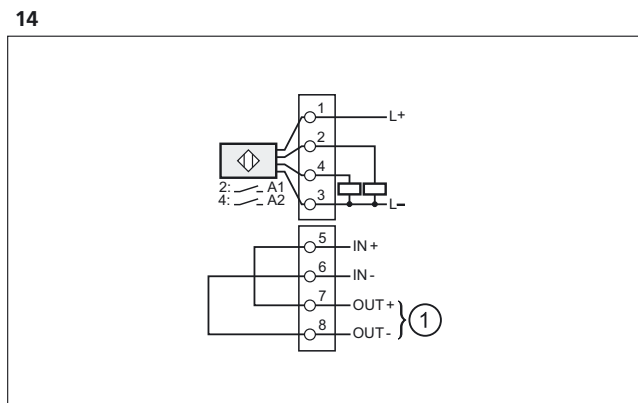
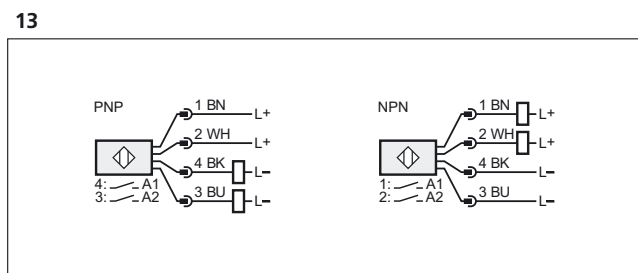
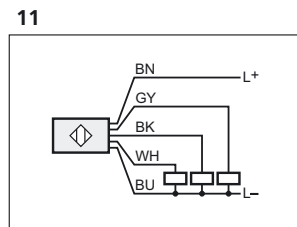
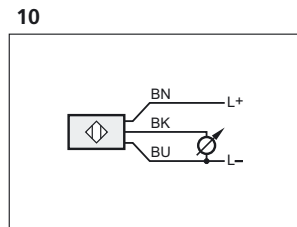

1: solenoid valve

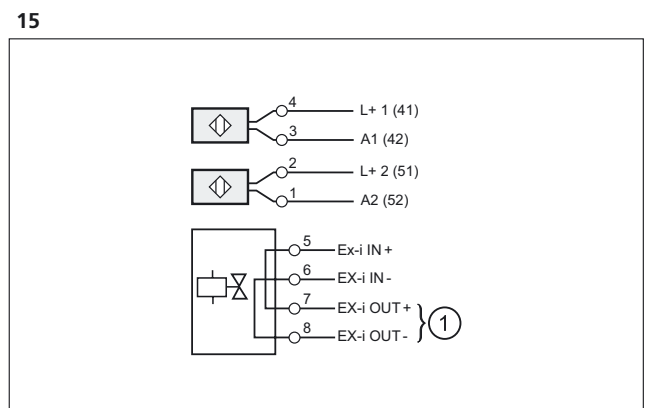

Wiring diagrams

16

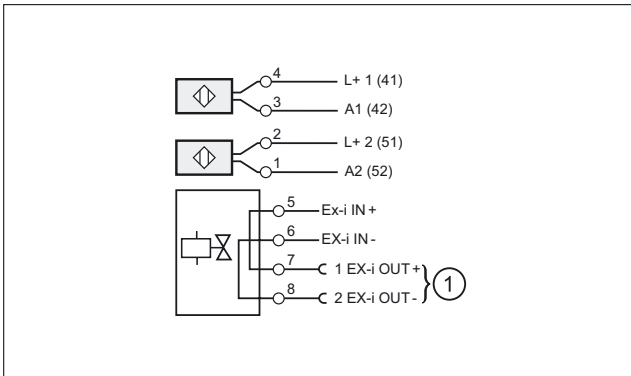

Scale drawings / drawing no. – CAD download: www.ifm.com

1

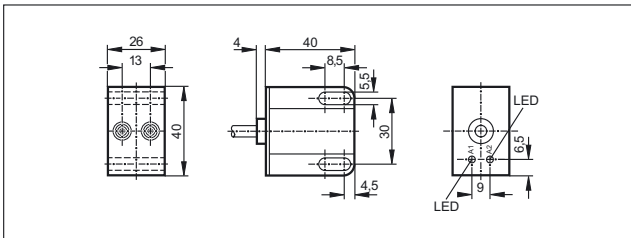

5

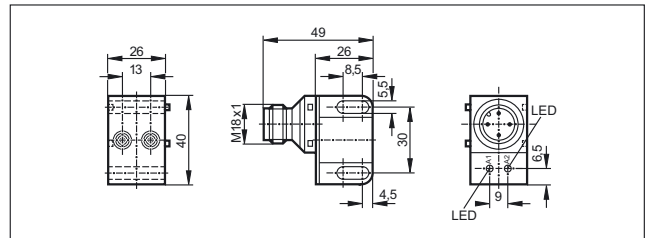

2

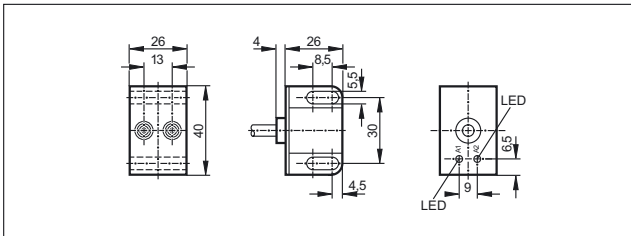

6

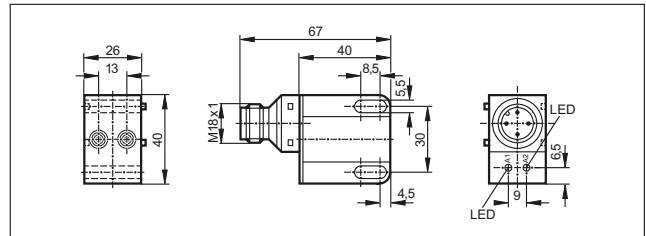

3

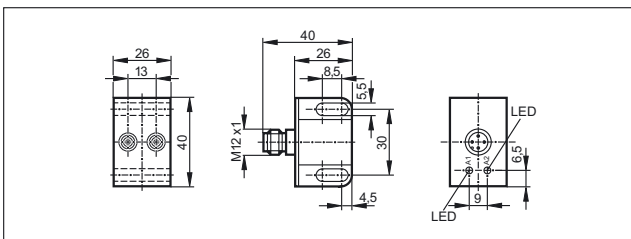

7

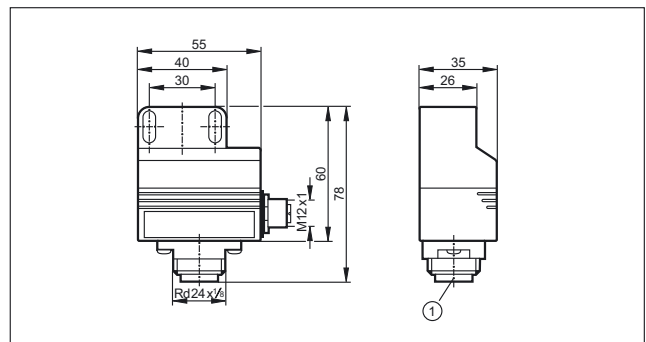

1: field connection

4

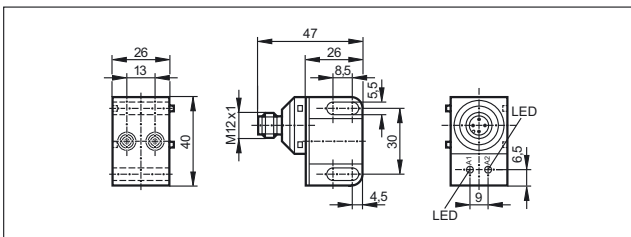

Scale drawings / drawing no. – CAD download: www.ifm.com

8

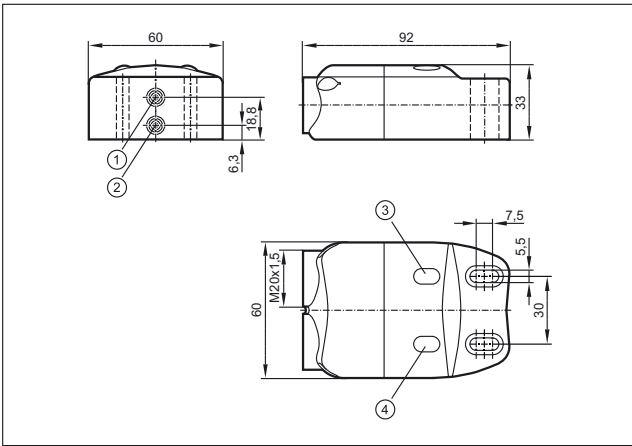

1: sensor 1, 2: sensor 2, 3: LED OUT 2, 4: LED OUT 1

9

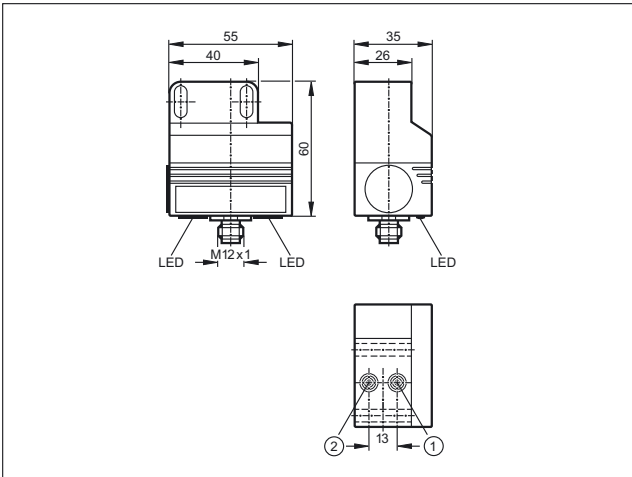

1: sensor 1, 2: sensor 2

10

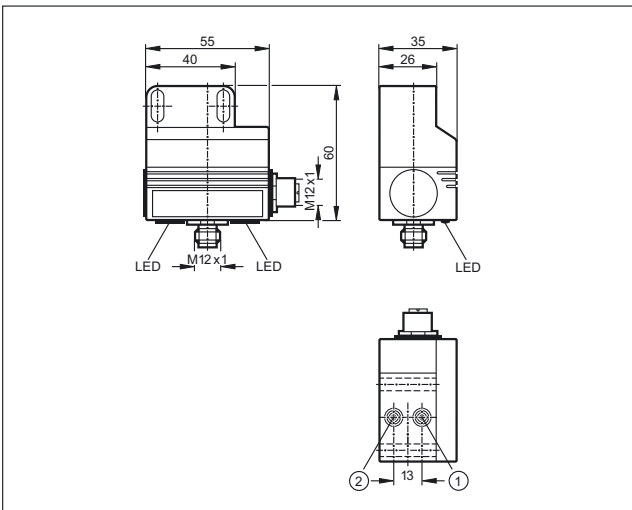

1: sensor 1, 2: sensor 2

11

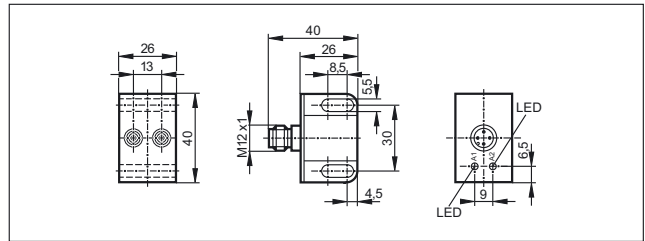

12

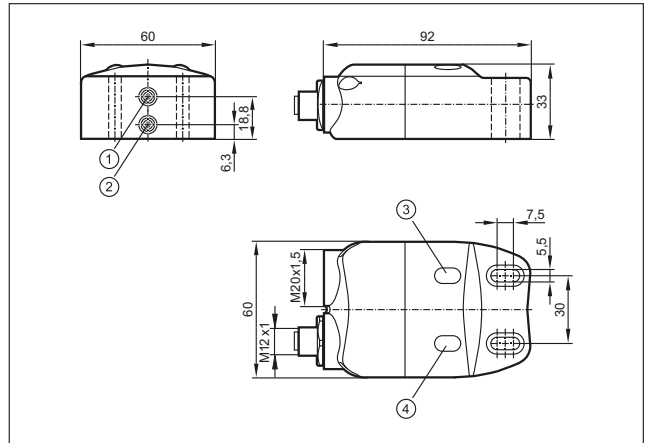

1: sensor 1, 2: sensor 2, 3: LED OUT 2, 4: LED OUT 1

13

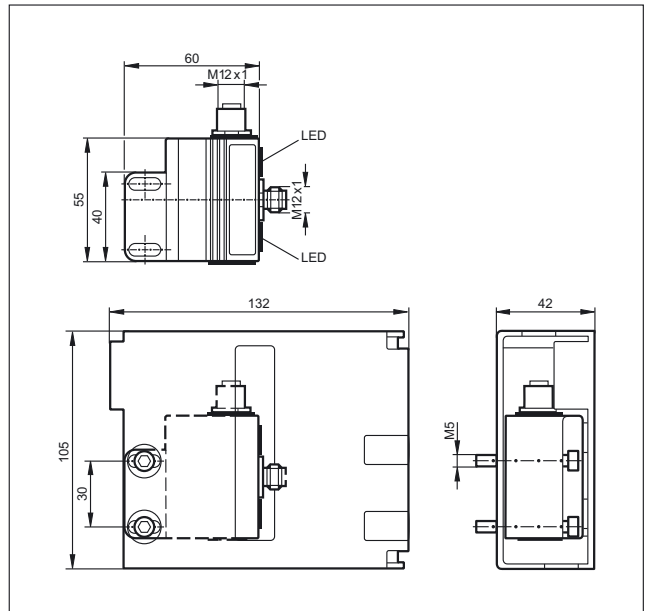

Scale drawings / drawing no. – CAD download: www.ifm.com

14

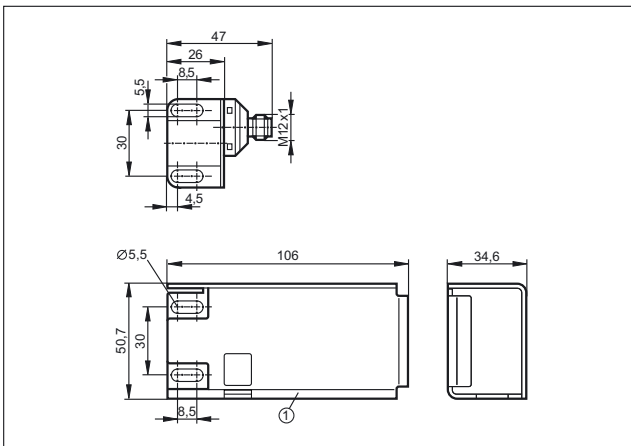

1: protective housing

15

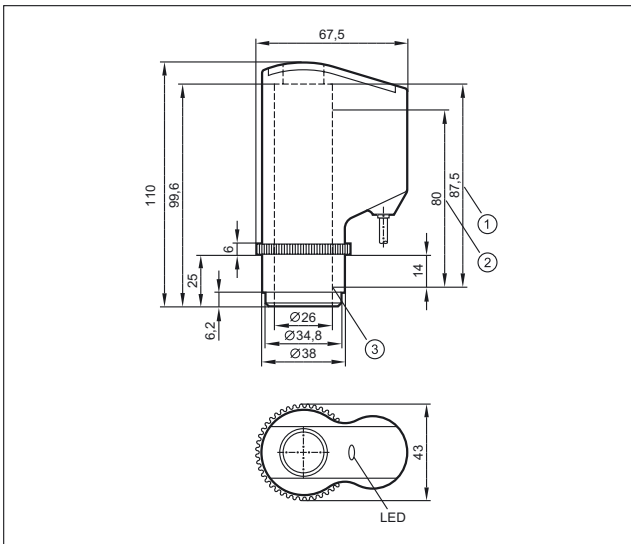

1: Max. spindle stroke, 2: Measuring range, 3: Initial value of the measuring range (zero point)

16

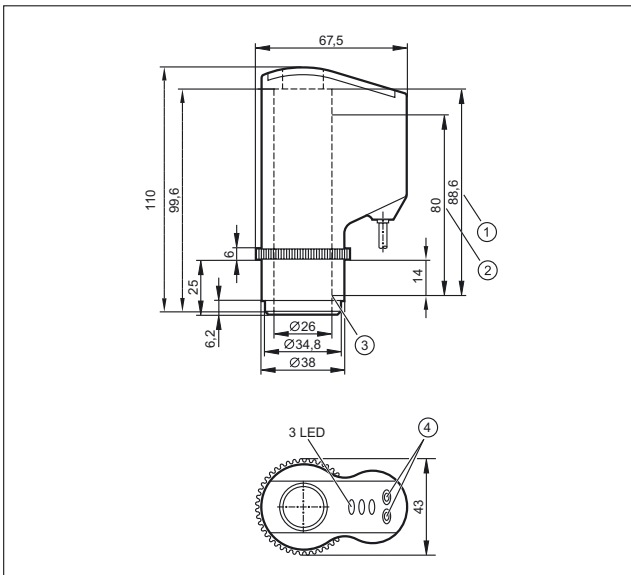

1: Max. spindle stroke, 2: Measuring distance, 3: Initial value of the measuring range (zero point), 4: Programming buttons

17

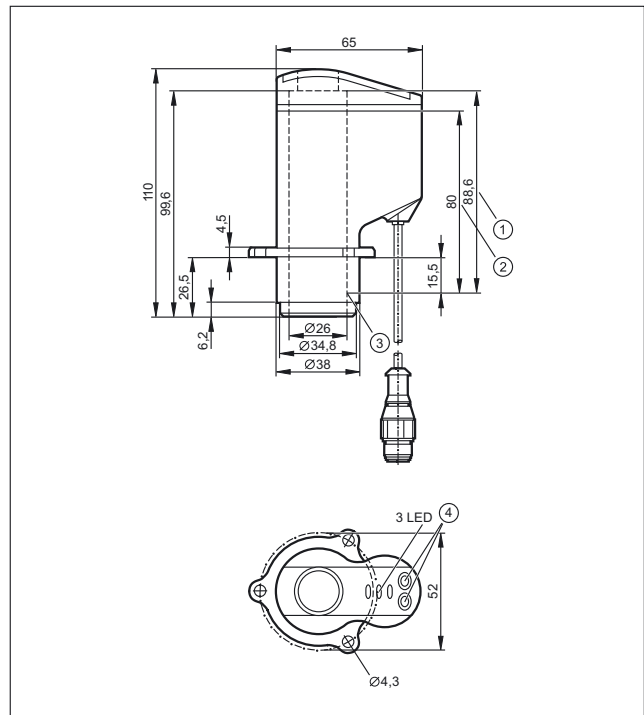

1: Max. spindle stroke, 2: Measuring distance, 3: Initial value of the measuring range (zero point), 4: Programming buttons

18

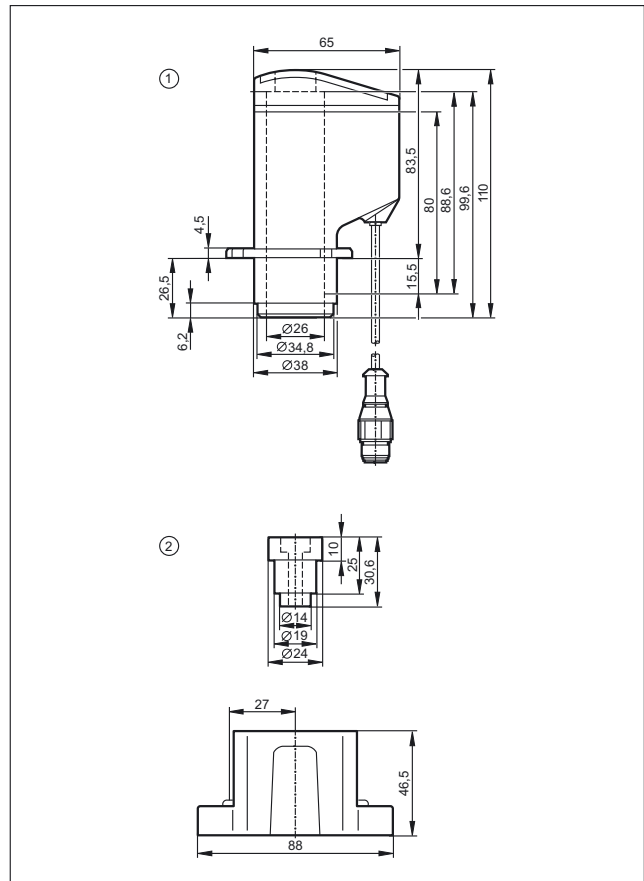

1: Valve sensor IX5010, 2: Mounting adapter E11900

Safe, easy, cost-optimised



Reduced cost: Reduced wiring complexity for faster installation and fewer error sources.



Bus system AS-Interface

AS-Interface (AS-i = actuator sensor interface) is a manufacturer-independent standard for the connection of actuators and sensors of the first field level. It is the only wiring system accepted worldwide. With more than 20 million slaves installed AS-i has been tried and tested as a low-cost feeder for all common fieldbuses for many years.

The product range includes AS-i components for different areas from packaging and conveying via silo applications, machine tools, robotics and automation to the food industry and mobile vehicles.

Safe

The sophisticated AS-i technology and the extended diagnostic possibilities provide high reliability and machine uptime.

"Safety at Work" is the extension of the AS-interface by safety-related components. Safety components up to SIL 3 to IEC 61508 and EN ISO 13849 - 1 / PL e can be connected to AS-i.

Easy

Due to the standardised system, the low wiring complexity and the quick connection technology, AS-i enables simple "Plug & Play". The reduction of terminals leads to reduced documentation.

Data and energy are jointly transmitted via a two-wire cable. The reverse polarity protected insulation displacement technology helps avoid errors. The modularity and the tree structure smoothly fit to the way the plant is put together.

Cost-optimised

It's the end result that matters: Wiring complexity, documentation and set-up times are significantly reduced.

The decentralisation of the AS-i participants leads to smaller and less expensive control cabinets. Simple diagnosis and a clear system design result in high machine uptime and avoid downtimes.

	<i>AS-Interface controllers / gateways</i>	586 - 590
	<i>AS-Interface power supplies / earth fault monitors</i>	592 - 593
	<i>AS-Interface I/O modules</i>	594 - 613
	<i>AS-Interface AirBoxes for pneumatics</i>	614 - 617
	<i>AS-Interface sensors</i>	618 - 620
	<i>AS-Interface devices for valves and valve actuators</i>	622 - 624
	<i>AS-Interface expansion</i>	626 - 627
	<i>AS-Interface Safety at Work</i>	628 - 634







AS-Interface controllers / gateways

AS-i controller and gateways have AS-i master functionality and are thus an elementary part of AS-i networks. These components are usually in a control cabinet and ensure data communication. A wide product range provides suitability for different applications. An integrated CODESYS-programmable PLC allows that the AS-i controllers can also be used as supplementary or independent control system.





System overview	Page
Controllers, gateways and software	586 - 587
Controllers / Gateways	587 - 588
AS-i manuals	588
Scale drawings / drawing no. – CAD download: www.ifm.com	588 - 590



Controllers, gateways and software

Type	Number of AS-i masters	Description	Drawing no.	Order no.
	1	AS-i DP controller E · AS-i PLC with Profibus-DP interface · Full master functions · Graphic display · Housing materials: aluminium / steel sheet galvanised	1	AC1365
	2	AS-i DP controller E · AS-i PLC with Profibus-DP interface · Full master functions · Graphic display · Housing materials: aluminium / steel sheet galvanised	1	AC1366
	1	AS-i controller E · AS-i controller freely programmable · Profibus DP interface · Ethernet programming interface · Full master functions · Graphic display · Housing materials: aluminium / steel sheet galvanised	1	AC1355
	2	AS-i controller E · AS-i controller freely programmable · Profibus DP interface · Ethernet programming interface · Full master functions · Graphic display · Housing materials: aluminium / steel sheet galvanised	1	AC1356
	1	AS-i Ethernet / IP Controller E · Full master functions · Graphic display · Housing materials: aluminium / steel sheet galvanised	2	AC1327
	2	AS-i Ethernet / IP Controller E · Full master functions · Graphic display · Housing materials: aluminium / steel sheet galvanised	2	AC1337
	1	AS-i DeviceNet controller E · AS-i controller with DeviceNet interface · Full master functions · Graphic display · Housing materials: aluminium / steel sheet galvanised	3	AC1318
	2	AS-i DeviceNet controller E · AS-i controller with DeviceNet interface · Full master functions · Graphic display · Housing materials: aluminium / steel sheet galvanised	3	AC1324
	1	AS-i CANopen Controller E · AS-i controller with CANopen interface · Full master functions · Graphic display · Housing materials: aluminium / steel sheet galvanised	4	AC1331



Type	Number of AS-i masters	Description	Draw- ing no.	Order no.
	2	AS-i CANopen Controller E · AS-i controller with CANopen interface · Full master functions · Graphic display · Housing materials: aluminium / steel sheet galvanised	5	AC1332
	1	AS-i controller E · AS-i controller freely programmable · Full master functions · Graphic display · Ethernet programming interface · Housing materials: aluminium / steel sheet galvanised	6	AC1357
	2	AS-i controller E · AS-i controller freely programmable · Full master functions · Graphic display · Ethernet programming interface · Housing materials: aluminium / steel sheet galvanised	7	AC1358
	–	CODESYS for Automation Alliance · Software CD for controller E Version 2.3 in several languages · Single user licence · Compatible operating systems: Win2000 (32 bits), WinXP (32/64 bits), WinVista (32/64 bits), Win7 (32/64 bits)	–	AC0340

Controllers / Gateways

Type	Number of AS-i masters	Description	Draw- ing no.	Order no.
	1	SmartLink DP · AS-i gateway / Profibus DP · Full master functions · Graphic display · Housing materials: aluminium / steel sheet galvanised	8	AC1375
	2	AS-i DP gateway · Full master functions · Graphic display · Profibus DP interface · Housing materials: aluminium / steel sheet galvanised	1	AC1376
	1	AS-i Profinet gateway · AS-i master · Ethernet configuration interface with dynamic web interface for configuration and diagnosis including remote maintenance · Profinet RT device class B · LCD colour display · Device supply either via 24 V or AS-i (AS-i bus 1) · Housing materials: aluminium powder-coated / steel sheet galvanised / Makrolon	9	AC1401
	2	AS-i Profinet gateway · AS-i master · Ethernet configuration interface with dynamic web interface for configuration and diagnosis including remote maintenance · Profinet RT device class B · LCD colour display · Device supply either via 24 V or AS-i (AS-i bus 1) · Housing materials: aluminium powder-coated / steel sheet galvanised / Makrolon	9	AC1402
	1	AS-i Profibus gateway · AS-i master · Ethernet configuration interface with dynamic web interface for configuration and diagnosis including remote maintenance · Profibus DP (DPV0 + DPV1) · LCD colour display · Device supply either via 24 V or AS-i (AS-i bus 1) · Housing materials: aluminium powder-coated / steel sheet galvanised / Makrolon	10	AC1411
	2	AS-i Profibus gateway · AS-i master · Ethernet configuration interface with dynamic web interface for configuration and diagnosis including remote maintenance · Profibus DP (DPV0 + DPV1) · LCD colour display · Device supply either via 24 V or AS-i (AS-i bus 1) · Housing materials: aluminium powder-coated / steel sheet galvanised / Makrolon	10	AC1412
	1	AS-i EtherNet/IP gateway · AS-i master · Ethernet configuration interface with dynamic web interface for configuration and diagnosis including remote maintenance · LCD colour display · Device supply either via 24 V or AS-i (AS-i bus 1) · Housing materials: aluminium powder-coated / steel sheet galvanised / Makrolon	9	AC1421

Type	Number of AS-i masters	Description	Drawing no.	Order no.
	2	AS-i EtherNet/IP gateway · AS-i master · Ethernet configuration interface with dynamic web interface for configuration and diagnosis including remote maintenance · LCD colour display · Device supply either via 24 V or AS-i (AS-i bus 1) · Housing materials: aluminium powder-coated / steel sheet galvanised / Makrolon	9	AC1422
	–	AS-i data decoupling module · Combicon connection · Housing materials: Makrolon	11	AC1250

AS-i manuals

Type	Description	Order no.
	ecolog asi system · AS-Interface Manual (German)	AC0115
	ecolog asi system · AS-Interface Manual (English)	AC0116

Scale drawings / drawing no. – CAD download: www.ifm.com

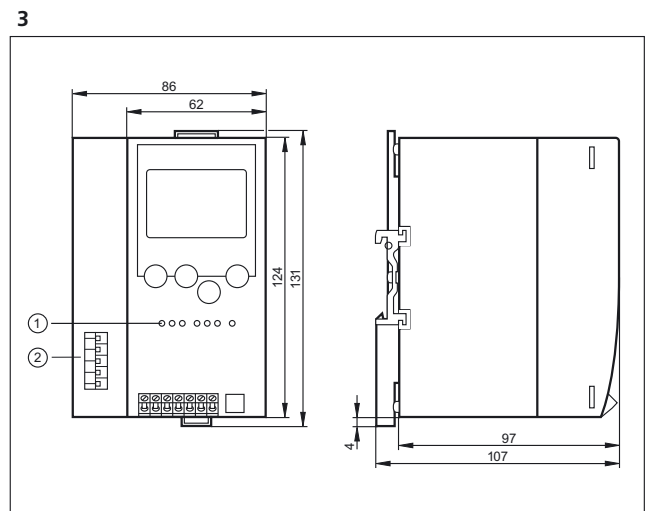
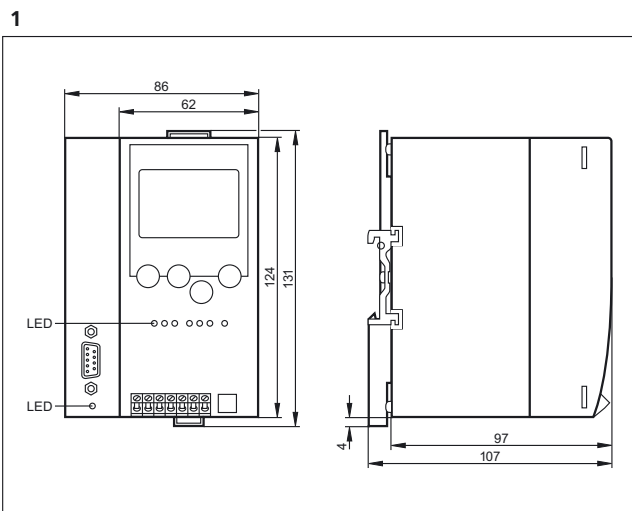

1: LED, 2: DeviceNet interface

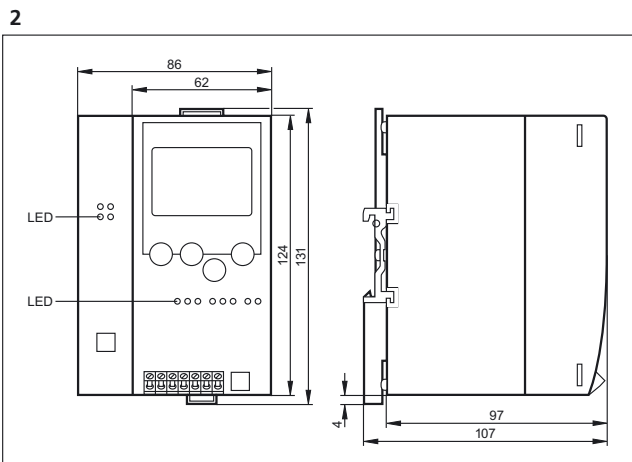

Scale drawings / drawing no. – CAD download: www.ifm.com

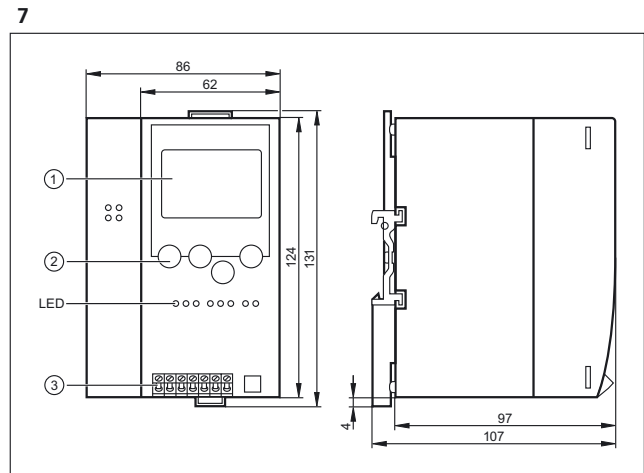
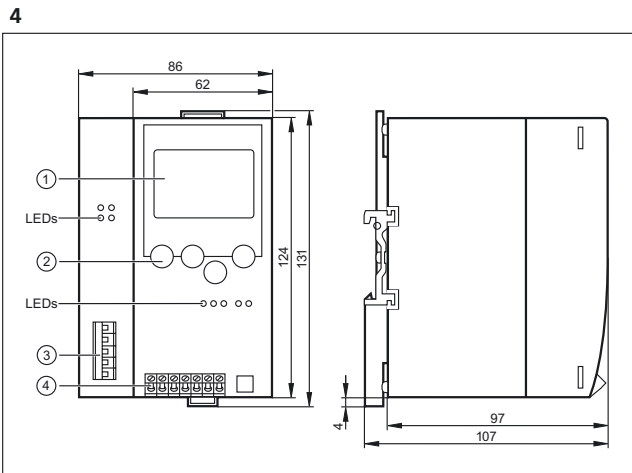

1: display, 2: control keys, 3: Ethernet interface

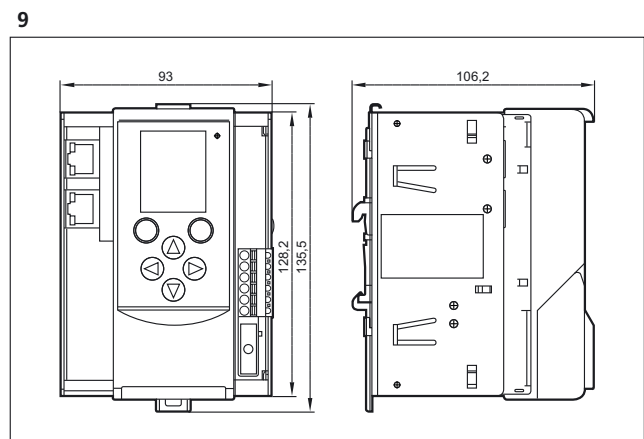
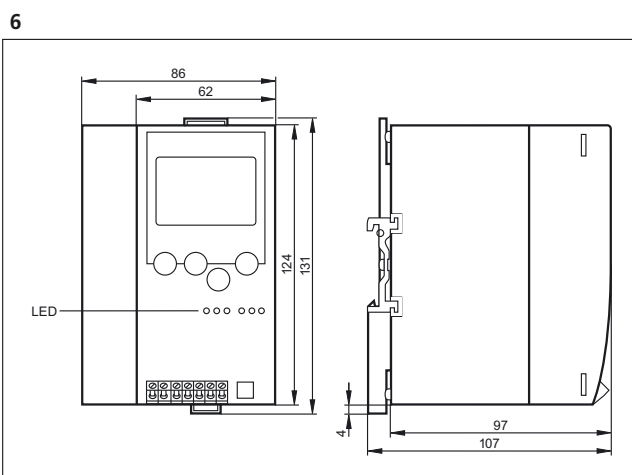
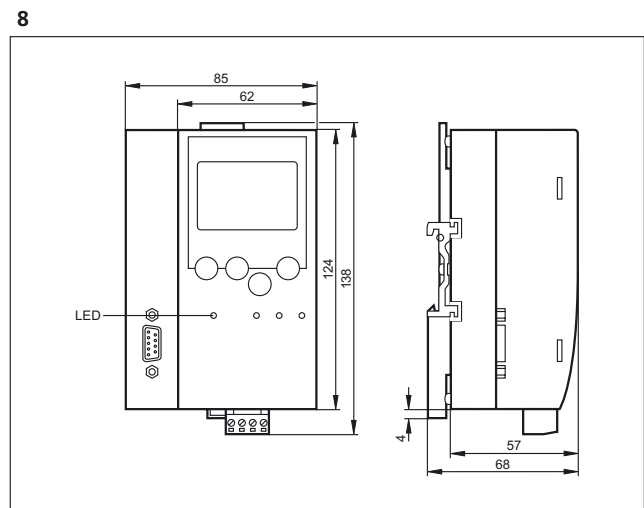
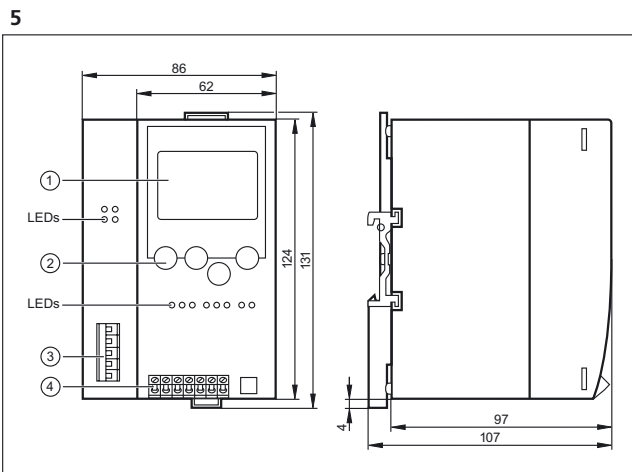

Scale drawings / drawing no. – CAD download: www.ifm.com

10

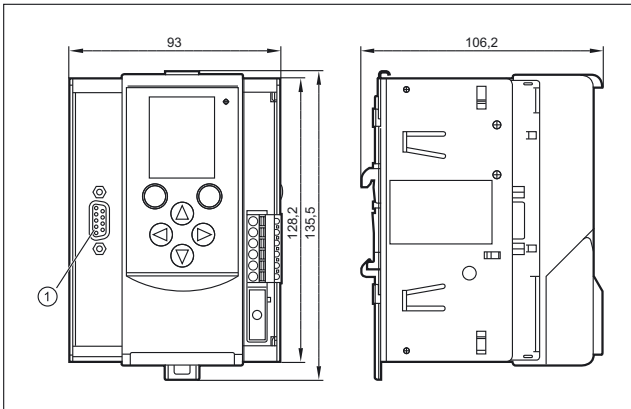

Sub-D (9-pole)

11

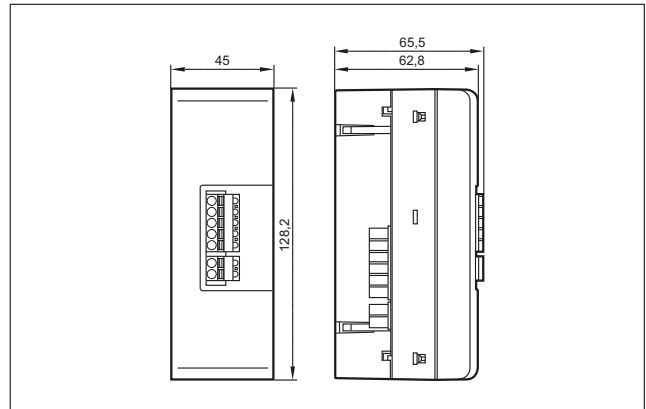









AS-Interface power supplies / earth fault monitors

AS-i needs special AS-i power supplies for the communication and the voltage supply of the AS-i modules and the connected inputs and outputs (partly). They supply an unearthed voltage that is in particular suitable for communication insensitive to interference, in particular in industrial environments. By means of earth fault monitors the installation can be monitored for earthing problems.

System overview	Page
AS-i power supplies	592
Insulation monitors	592
Scale drawings / drawing no. – CAD download: www.ifm.com	593

AS-i power supplies

Type	Output current AS-i [A]	Description	Draw-ing no.	Order no.
	2.8	Power supply · AS-i power supply 115/230 V AC · Integrated data decoupling · NEC Class II Power Source · steel sheet	1	AC1256
	4	Power supply · DC convertor 24 V DC for AS-i system voltage · Integrated data decoupling · steel sheet	2	AC1257
	4	Power supply · AS-i power supply 115/230 V AC · Integrated data decoupling · steel sheet	1	AC1254
	8	Power supply · AS-i power supply 115/230 V AC · Integrated data decoupling · steel sheet	3	AC1258
	8	Power supply · Three-phase AS-i power supply 380...480 V AC · Integrated data decoupling · steel sheet	4	AC1253

Insulation monitors

Type	Description	Draw-ing no.	Order no.
	AS-i insulation monitor · Detection of asymmetric insulation faults · Screw terminal	5	AC2211
	AS-i insulation monitor · Detection of symmetric and asymmetric insulation faults · Screw terminal	5	AC2212

Scale drawings / drawing no. – CAD download: www.ifm.com

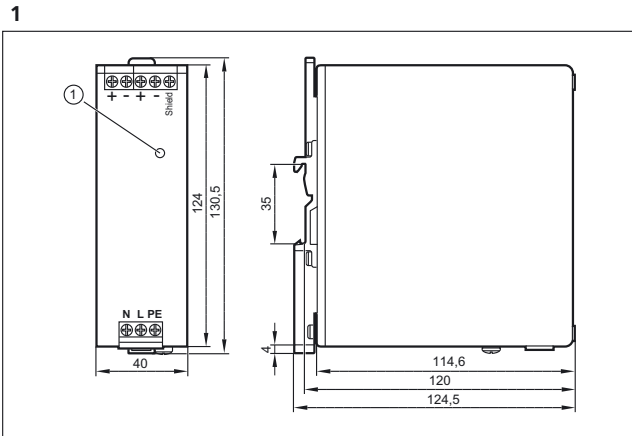

1: LED AS-i ok

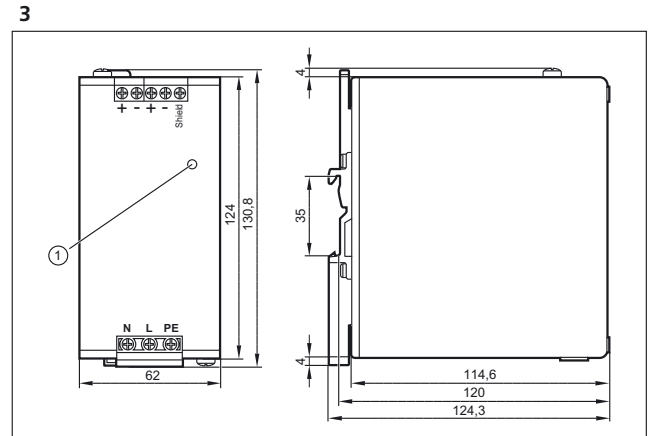

1: LED AS-i ok

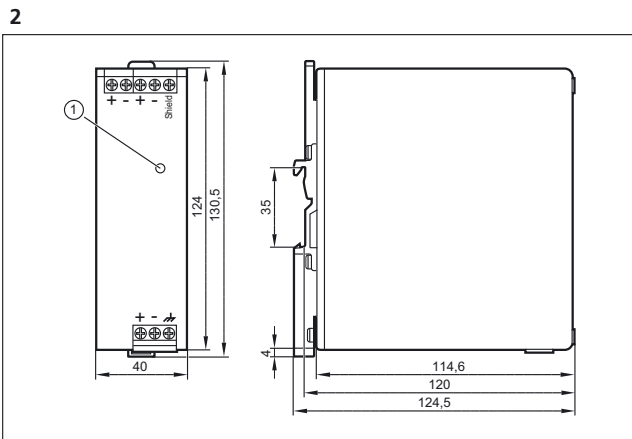

1: LED AS-i ok

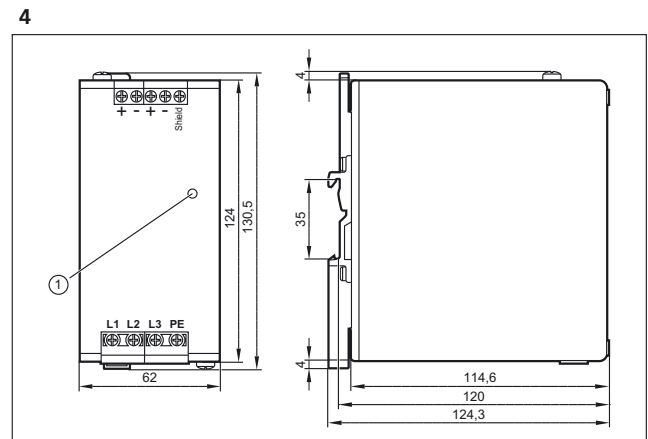

1: LED AS-i ok

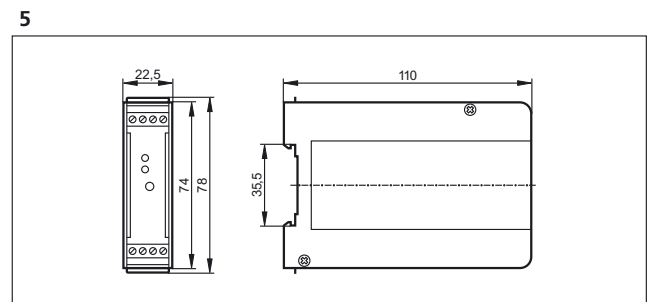





AS-Interface I/O modules

The I/O modules are decentralised input and output modules of the AS-i interface for the connection of your digital and analogue inputs and outputs. Different applications have various requirements on the I/O modules regarding protection rating, resistance and materials used. The product range covers PCB solutions, control cabinet modules and I/O modules with protection rating IP69K.

System overview	Page
IO-Link components	594 - 595
I/O modules for control cabinets	595 - 596
Field modules IP 67 AS-Interface	597 - 599
CompactLine modules	600 - 601
Field modules IP 67 Profibus DP	601 - 602
Universal modules AS-Interface	602
Field modules IP 69K and accessories	603
Module lower parts	603
Combicon connectors	604
Flat cable splitters and accessories	604 - 605
Accessories lower parts and addressing units	606 - 607
Scale drawings / drawing no. – CAD download: www.ifm.com	607 - 613

IO-Link components

Type	Inputs / outputs	Description	Drawing no.	Order no.
	max. 8 IO-Link ports / max. 12 digital inputs / max. 8 digital outputs	IO-Link master with Profinet interface · I/O modules for field applications · housing: PA / socket: Brass nickel-plated	1	AL1000
	max. 8 IO-Link ports / max. 12 digital inputs / max. 8 digital outputs	IO-Link master with Profibus interface · I/O modules for field applications · Sockets M12 x 1 · housing: PA / socket: Brass nickel-plated	2	AL1010
	max. 8 IO-Link ports / max. 12 digital inputs / max. 8 digital outputs	IO-Link master with EtherNet/IP interface · I/O modules for field applications · Sockets M12 x 1 · housing: PA / socket: Brass nickel-plated	1	AL1020
	max. 8 IO-Link ports / max. 12 digital inputs / max. 8 digital outputs	IO-Link master with EtherCat interface · I/O modules for field applications · Sockets M12 x 1 · housing: PA / socket: Brass nickel-plated	1	AL1030
	4 x 2 inputs	Active CompactLine module (IO-Link device) · Supply via IO-Link M12 connector · Digital inputs · Sockets M12 x 1 · PA / socket: Brass nickel-plated / O-Ring : Viton	3	AL2400





Type	Inputs / outputs	Description	Draw- ing no.	Order no.
	8 x 2 inputs	Active CompactLine module (IO-Link device) · Supply via IO-Link M12 connector · Digital inputs · Sockets M12 x 1 · PA / socket: Brass nickel-plated / O-Ring : Viton	4	AL2401
	8 IO-Link ports / 10 digital inputs / 2 digital inputs or outputs	I/O modules for use in the control cabinet · IO-Link master 8 ports A and B variable · LineRecorder Agent embedded · 2 Ethernet ports with integrated switch · Additional binary inputs and outputs can be configured · Housing for DIN rail mounting · Screw terminal · housing: polyamide	5	AY1000
	8 IO-Link ports / 10 digital inputs / 2 digital inputs or outputs	I/O modules for use in the control cabinet · IO-Link master 8 ports A and B variable · LineRecorder Agent embedded · 2 Ethernet ports with integrated switch · Additional binary inputs and outputs can be configured · Housing for DIN rail mounting · Screw terminal · housing: polyamide	5	AY1020

I/O modules for control cabinets

Type	Inputs / outputs	Description	Draw- ing no.	Order no.
	4 inputs	Active AS-i module · String mounting possible · Addressing socket · Version 2.1 with extended addressing mode · Digital inputs · Combicon connection · PA	6	AC2250
	4 inputs	Active AS-i module · String mounting possible · Addressing socket · Input supply from external PELV voltage source · Version 2.1 with extended addressing mode · Digital inputs · Combicon connection · PA	6	AC2254
	4 outputs	Active AS-i module · String mounting possible · Addressing socket · Version 2.1 · Digital outputs · Combicon connection · PA	6	AC2252
	4 inputs / 2 outputs / relay	Active AS-i module · String mounting possible · Addressing socket · Version 2.1 with extended addressing mode · Digital inputs · Combicon connection · PA	6	AC2256
	4 inputs / 2 outputs / relay	Active AS-i module · String mounting possible · Addressing socket · Input supply from external PELV voltage source · Version 2.1 with extended addressing mode · Digital inputs and outputs · Combicon connection · PA	6	AC2255
	4 inputs / 3 outputs	Active AS-i module · String mounting possible · Addressing socket · Version 2.1 with extended addressing mode · Digital inputs and outputs · Combicon connection · PA	6	AC2264
	4 inputs / 4 outputs	Active AS-i module · String mounting possible · Addressing socket · Version 2.1 · Digital inputs and outputs · Combicon connection · PA	6	AC2251
	4 inputs / 4 outputs	Active AS-i module · String mounting possible · Addressing socket · External sensor supply PELV · Version 2.1 · Digital inputs and outputs · Combicon connection · PA	6	AC2257
	4 inputs / 4 outputs	Active AS-i module · String mounting possible · Addressing socket · External sensor supply PELV · Version 3.0 with extended addressing mode · Only for operation with AS-i masters with the profile M4 · Digital inputs and outputs · Combicon connection · PA	7	AC2267
	4 inputs 4...20 mA	Active AS-i module · AS-i profile S-7.3 · 4 analogue inputs 4...20 mA · Supply either from AS-i or an external 24 V source · For the connection of 2-wire, 3-wire or 4-wire sensors · Combicon connector for sensor connection · PA 6.6	6	AC2216
	4 inputs 0...10 V	Active AS-i module · AS-i profile S-7.3 · 4 analogue inputs 0...10 V · For the connection of 2-wire, 3-wire or 4-wire sensors · Combicon connector for sensor connection · PA 6.6	6	AC2217

Type	Inputs / outputs	Description	Draw- ing no.	Order no.
	4 outputs 0...20 mA	Active AS-i module · AS-i profile S-7.3 · 4 analogue outputs 0...20 mA · For the connection of 2-wire actuators or 4-wire actuators with separate 24 V supply · Combicon connector for actuator connection · PA 6.6	6	AC2218
	4 outputs 0...10 V	Active AS-i module · AS-i profile S-7.3 · 4 analogue outputs 0...10 V · For the connection of 2-wire actuators or 4-wire actuators with separate 24 V supply · Combicon connector for actuator connection · PA 6.6	6	AC2219
	4 inputs Pt100	Active AS-i module · 4 analogue inputs temperature Pt100 · AS-i profile S-7.3 · Combicon connection · PBT	6	AC2220
	4 inputs / 4 outputs / relay	Active AS-i module · String mounting possible · Addressing socket · Version 2.1 · Combicon connection · PA 6.6	8	AC2258
	4 inputs / 4 outputs / relay	Active AS-i module · String mounting possible · Addressing socket · Input supply from external PELV voltage source · Version 2.1 · Combicon connection · PA 6.6	8	AC2259
	4 inputs / 4 outputs	Active AS-i module · PCB size 105 x 45 x 17 mm · Wire length 0.2 m · Digital inputs and outputs	9	AC2709
	4 inputs / 3 outputs	Active AS-i module · AS-i slave with extended addressing mode · PCB size 105 x 45 x 17 mm · Wire length 0.2 m · Digital inputs and outputs	9	AC2739
	2 inputs / 1 LED output	Active AS-i module · Only suited for mechanical contacts · Wire length 0.1 m	10	AC2729
	3 inputs / 3 outputs	Active AS-i module · AS-i version 2.1 with extended addressing mode	11	AC2731
	4 inputs / 4 outputs	Active AS-i module · AS-i slave with extended addressing mode · Only for operation with AS-i masters with the profile M4 · 12 x 0.2 m · housing: PC potted	12	AC2750
	4 inputs / 3 outputs	Active AS-i module · AS-i slave with extended addressing mode · 11 x 0.2 m · housing: PC potted	13	AC2751
	4 inputs / 4 outputs	Active AS-i module · AS-i slave with extended addressing mode · Only for operation with AS-i masters with the profile M4 · housing: PC potted	14	AC2752
	4 inputs / 3 outputs	Active AS-i module · AS-i slave with extended addressing mode · housing: PC potted	15	AC2753
	4 inputs / 4 outputs	Active AS-i module · String mounting possible · Version 3.0 with extended addressing mode · Only for operation with AS-i masters with the profile M4 · plastics / PC GF20	16	AC3200
	4 inputs / 4 outputs	Active AS-i module · String mounting possible · Version 3.0 with extended addressing mode · Only for operation with AS-i masters with the profile M4 · plastics / PC GF20	16	AC3201
	4 inputs / 4 outputs	Active AS-i module · String mounting possible · Addressing socket · Version 3.0 with extended addressing mode · Only for operation with AS-i masters with the profile M4 · plastics / PC GF20	17	AC3220
	4 inputs / 4 outputs	Active AS-i module · String mounting possible · Addressing socket · Version 3.0 with extended addressing mode · Only for operation with AS-i masters with the profile M4 · plastics / PC GF20	17	AC3221



Field modules IP 67 AS-Interface







Type	Inputs / outputs	Description	Draw- ing no.	Order no.
	4-way splitter box	ClassicLine splitter box module · Three orientations of the flat cable are possible · AS-i and AUX splitter box for the connection of intelligent sensors/actuators · Sockets M12 x 1 · PA / Piercing contacts: CuSn6 surface nickel and tin-plated	18	AC5200
	4 inputs	Active ClassicLine module · Addressing socket · Three orientations of the flat cable are possible · Digital inputs · Sockets M12 x 1 · PA / Piercing contacts: CuSn6 surface nickel and tin-plated	18	AC5205
	4 inputs	Active ClassicLine module · Version 2.11 and 3.0 with extended addressing mode · Addressing socket · Three orientations of the flat cable are possible · Digital inputs · Sockets M12 x 1 · PA / Piercing contacts: CuSn6 surface nickel and tin-plated	18	AC5215
	4 analogue inputs 4...20 mA	Active ClassicLine module · 4 analogue inputs 4...20 mA · For the connection of 2-wire and 3-wire sensors · Three orientations of the flat cable are possible · PA / Piercing contacts: CuSn6 surface nickel and tin-plated	18	AC5216
	3 outputs	Active ClassicLine module · Version 2.11 and 3.0 with extended addressing mode · Addressing socket · Three orientations of the flat cable are possible · Digital outputs · Sockets M12 x 1 · PA / Piercing contacts: CuSn6 surface nickel and tin-plated	18	AC5203
	4 outputs	Active ClassicLine module · Addressing socket · Three orientations of the flat cable are possible · Digital outputs · Sockets M12 x 1 · PA / Piercing contacts: CuSn6 surface nickel and tin-plated	18	AC5208
	4 outputs	Active ClassicLine module · Addressing socket · Three orientations of the flat cable are possible · Digital outputs 2 A · Sockets M12 x 1 · PA / Piercing contacts: CuSn6 surface nickel and tin-plated	18	AC5213
	2 outputs / 2 inputs	Active ClassicLine module · Version 2.11 and 3.0 with extended addressing mode · Addressing socket · Three orientations of the flat cable are possible · Digital outputs and inputs · Sockets M12 x 1 · PA / Piercing contacts: CuSn6 surface nickel and tin-plated	18	AC5214
	2 inputs / 2 outputs	Active ClassicLine module · Addressing socket · Three orientations of the flat cable are possible · Digital inputs and outputs (2 A) · Sockets M12 x 1 · PA / Piercing contacts: CuSn6 surface nickel and tin-plated	18	AC5211
	2 outputs / 2 inputs	Active ClassicLine module · Version 2.11 and 3.0 with extended addressing mode · Addressing socket · Three orientations of the flat cable are possible · Outputs supplied from AS-i · Digital outputs and inputs · Sockets M12 x 1 · PA / Piercing contacts: CuSn6 surface nickel and tin-plated	18	AC5224
	4 inputs / 3 outputs	Active ClassicLine module · Version 2.11 and 3.0 with extended addressing mode · Addressing socket · Three orientations of the flat cable are possible · inputs externally supplied · Sockets M12 x 1 · PA / Piercing contacts: CuSn6 surface nickel and tin-plated	19	AC5292

Type	Inputs / outputs	Description	Draw- ing no.	Order no.
	8 digital inputs (2 slaves)	Active ClassicLine module · Version 2.11 and 3.0 with extended addressing mode · Addressing socket · Three orientations of the flat cable are possible · Digital inputs · Sockets M12 x 1 · PA / Piercing contacts: CuSn6 surface nickel and tin-plated	19	AC5210
	4 inputs / 4 outputs	Active ClassicLine module · Addressing socket · Three orientations of the flat cable are possible · Digital inputs and outputs · Sockets M12 x 1 · PA / Piercing contacts: CuSn6 surface nickel and tin-plated	19	AC5209
	4 inputs / 4 outputs	Active ClassicLine module · Addressing socket · Three orientations of the flat cable are possible · Digital inputs and outputs (2 A) · Sockets M12 x 1 · PA / Piercing contacts: CuSn6 surface nickel and tin-plated	19	AC5212
	4 inputs / 3 outputs	Active ClassicLine module · Addressing socket · Three orientations of the flat cable are possible · Version 2.11 and 3.0 with extended addressing mode · Digital inputs and outputs · Sockets M12 x 1 · PA / Piercing contacts: CuSn6 surface nickel and tin-plated	19	AC5204
	4 inputs / 4 outputs	Active ClassicLine module · Only for operation with AS-i masters with the profile M4 · Addressing socket · Three orientations of the flat cable are possible · Version 3.0 with extended addressing mode · Digital inputs and outputs · Sockets M12 x 1 · PA / Piercing contacts: CuSn6 surface nickel and tin-plated	19	AC5235
	4 inputs / 4 outputs	Active ClassicLine module · Addressing socket · Three orientations of the flat cable are possible · Version 3.0 with extended addressing mode · Only for operation with AS-i masters with the profile M4 · Digital inputs and outputs (2 A) · Sockets M12 x 1 · PA / Piercing contacts: CuSn6 surface nickel and tin-plated	19	AC5236
	2 pushbuttons / 2 LED displays	Active module upper parts AS-i illuminated pushbutton module · Power supply via AS-i cable · A/B slave · Pushbutton functions: normally open / normally closed · PBT	–	AC2088
	2 pushbuttons / 2 LED displays	Active module upper parts AS-i illuminated pushbutton module · Power supply via AS-i cable · Colour inserts changeable · PBT	20	AC2086
	1 pushbutton / 1 key-operated switch / 1 LED display	Active module upper part AS-i illuminated pushbutton module with key-operated switch · Power supply via AS-i cable · Version 2.1 with extended addressing mode · PBT	20	AC2087
	4 inputs 4...20 mA	Active ClassicLine module · AS-i profile S-7.3 · 4 analogue inputs 4...20 mA · IR addressing possible · For the connection of 2-wire, 3-wire or 4-wire sensors · Sockets M12 x 1 · PBT	21	AC2516
	4 inputs 0...10 V	Active ClassicLine module · AS-i profile S-7.3 · 4 analogue inputs 0...10 V · IR addressing possible · For the connection of 2-wire, 3-wire or 4-wire sensors · Sockets M12 x 1 · PBT	21	AC2517
	2 inputs 4...20 mA	Active ClassicLine module · 2 analogue inputs 4...20 mA · For the connection of 2-wire and 3-wire sensors · Addressing socket · Three orientations of the flat cable are possible · PA / Piercing contacts: CuSn6 surface nickel and tin-plated	18	AC5222

Type	Inputs / outputs	Description	Draw- ing no.	Order no.
	2 inputs 4...20 mA	Active ClassicLine module · 2 analogue inputs 4...20 mA · For the connection of 2-wire and 4-wire sensors · Electrical isolation · Addressing socket · Three orientations of the flat cable are possible · PA / Piercing contacts: CuSn6 surface nickel and tin-plated	18	AC5223
	2 IO-Link ports	Active ClassicLine module · 2 IO-Link ports · For the connection of IO-Link sensors and actuators, binary sensors and binary actuators · Addressing socket · Three orientations of the flat cable are possible · Only for operation with AS-i masters with the profile M4 · PA / Piercing contacts: CuSn6 surface nickel and tin-plated	18	AC5225
	4 analogue inputs 4...20 mA	Active ClassicLine module · 4 analogue inputs 4...20 mA · For the connection of 2-wire, 3-wire or 4-wire sensors · Electrical isolation · Three orientations of the flat cable are possible · PA / Piercing contacts: CuSn6 surface nickel and tin-plated	18	AC5226
	2 digital inputs / 1 analogue input / 1 analogue output	Active ClassicLine module · Only for operation with AS-i masters with the profile M4 · Electrical isolation · Three orientations of the flat cable are possible · Sockets M12 x 1 · PA / Piercing contacts: CuSn6 surface nickel and tin-plated	18	AC5230
	4 inputs	Active ClassicLine module · Addressing socket · Three orientations of the flat cable are possible · ATEX approval · Group II, category 3D · Only in conjunction with impact protection housing E7000A or equivalent protection · Sockets M12 x 1 · PA / Piercing contacts: CuSn6 surface nickel and tin-plated	18	AC505A
	4 inputs	Active ClassicLine module · Version 2.11 and 3.0 with extended addressing mode · Addressing socket · Three orientations of the flat cable are possible · ATEX approval · Group II, category 3D · Only in conjunction with impact protection housing E7000A or equivalent protection · Sockets M12 x 1 · PA / Piercing contacts: CuSn6 surface nickel and tin-plated	18	AC515A
	4 outputs	Active ClassicLine module · Addressing socket · Three orientations of the flat cable are possible · ATEX approval · Group II, category 3D · Only in conjunction with impact protection housing E7000A or equivalent protection · Sockets M12 x 1 · PA / Piercing contacts: CuSn6 surface nickel and tin-plated	18	AC508A
	2 inputs / 2 outputs	Active ClassicLine module · Addressing socket · Three orientations of the flat cable are possible · ATEX approval · Group II, category 3D · Only in conjunction with impact protection housing E7000A or equivalent protection · Digital inputs and outputs (2 A) · Sockets M12 x 1 · PA / Piercing contacts: CuSn6 surface nickel and tin-plated	18	AC507A
	2 outputs / 2 inputs	Active ClassicLine module · Version 2.11 and 3.0 with extended addressing mode · Addressing socket · Three orientations of the flat cable are possible · ATEX approval · Group II, category 3D · Only in conjunction with impact protection housing E7000A or equivalent protection · Sockets M12 x 1 · PA / Piercing contacts: CuSn6 surface nickel and tin-plated	18	AC514A
	2 inputs 4...20 mA	Active AS-i module · 2 analogue inputs 4...20 mA · For the connection of 2-wire and 3-wire sensors · Addressing socket · Three orientations of the flat cable are possible · ATEX approval · Group II, category 3D · Only in conjunction with impact protection housing E7000A or equivalent protection · PA / Piercing contacts: CuSn6 surface nickel and tin-plated	18	AC522A
	4 inputs / 4 outputs	Active ClassicLine module · Only for operation with AS-i masters with the profile M4 · Addressing socket · Three orientations of the flat cable are possible · Version 3.0 with extended addressing mode · ATEX approval · Group II, category 3D · Only in conjunction with impact protection housing E7000A or equivalent protection · Sockets M12 x 1 · PA / Piercing contacts: CuSn6 surface nickel and tin-plated	19	AC535A

CompactLine modules

Type	Inputs / outputs	Description	Draw- ing no.	Order no.
	2 inputs 4...20 mA	Active CompactLine module · 2 analogue inputs 4...20 mA · For the connection of 2-wire and 3-wire sensors · IR addressing possible · high-grade stainless steel · Sockets M12 x 1 · PA / socket: stainless steel 316L / 1.4404 / threaded inserts in the lower part: stainless steel 316L / 1.4404 / screws in the lower part: stainless steel / Piercing contacts: CuSn6 surface nickel and tin-plated	22	AC2402
	2 inputs 4...20 mA	Active CompactLine module · 2 analogue inputs 4...20 mA · For the connection of 2-wire and 4-wire sensors · Electrical isolation · IR addressing possible · high-grade stainless steel · Sockets M12 x 1 · PA / socket: stainless steel 316L / 1.4404 / threaded inserts in the lower part: stainless steel 316L / 1.4404 / screws in the lower part: stainless steel / Piercing contacts: CuSn6 surface nickel and tin-plated	22	AC2403
	4-way splitter box	Passive compact module · AS-i splitter box for the connection of intelligent sensors/actuators · Sockets M12 x 1 · PA 6.6 / socket: Brass nickel-plated / threaded inserts in the lower part: Brass nickel-plated / O-Ring : Viton / Piercing contacts: CuSn6 surface nickel and tin-plated	23	AC2413
	4 inputs	Active CompactLine module · fully potted housing · IR addressing possible · Digital inputs · Sockets M12 x 1 · PA / socket: Brass nickel-plated / threaded inserts in the lower part: Brass nickel-plated / O-Ring : Viton / Piercing contacts: CuSn6 surface nickel and tin-plated	24	AC2410
	4 inputs	Active CompactLine module · IR addressing possible · Version 2.11 and 3.0 with extended addressing mode · Digital inputs · Sockets M12 x 1 · PA / socket: Brass nickel-plated / threaded inserts in the lower part: Brass nickel-plated / O-Ring : Viton / Piercing contacts: CuSn6 surface nickel and tin-plated	24	AC2457
	4 inputs	Active CompactLine module · IR addressing possible · Metal parts from stainless steel · Digital inputs · Sockets M12 x 1 · PA / socket: stainless steel 316L / 1.4404 / threaded inserts in the lower part: stainless steel 316L / 1.4404 / screws: stainless steel / Piercing contacts: CuSn6 surface nickel and tin-plated / O-Ring : EPDM	24	AC2451
	4 outputs	Active CompactLine module · IR addressing possible · Digital outputs · Sockets M12 x 1 · PA / socket: Brass nickel-plated / threaded inserts in the lower part: Brass nickel-plated / O-Ring : Viton / Piercing contacts: CuSn6 surface nickel and tin-plated	25	AC2417
	2 inputs / 2 outputs	Active CompactLine module · 60 x 118.2 x 27 · IR addressing possible · Digital inputs and outputs · Sockets M12 x 1 · PA / socket: Brass nickel-plated / threaded inserts in the lower part: Brass nickel-plated / O-Ring : Viton / Piercing contacts: CuSn6 surface nickel and tin-plated	25	AC2411
	2 inputs / 2 outputs	Active CompactLine module · IR addressing possible · Digital inputs and outputs · Sockets M12 x 1 · PA / socket: Brass nickel-plated / threaded inserts in the lower part: Brass nickel-plated / O-Ring : Viton / Piercing contacts: CuSn6 surface nickel and tin-plated	25	AC2458
	4 inputs / 4 outputs	Active CompactLine module · 60 x 152 x 27 · IR addressing possible · Digital inputs and outputs · Sockets M12 x 1 · PA / socket: Brass nickel-plated / threaded inserts in the lower part: Brass nickel-plated / O-Ring : Viton / Piercing contacts: CuSn6 surface nickel and tin-plated	26	AC2412
	4 inputs / 4 outputs	Active CompactLine module · IR addressing possible · Digital inputs and outputs · Sockets M12 x 1 · PA / socket: Brass nickel-plated / threaded inserts in the lower part: Brass nickel-plated / O-Ring : Viton / Piercing contacts: CuSn6 surface nickel and tin-plated	26	AC2459





Type	Inputs / outputs	Description	Draw- ing no.	Order no.
	4 inputs / 4 outputs	Active CompactLine module · IR addressing possible · External sensor supply PELV · Digital inputs and outputs · Sockets M12 x 1 · PA / socket: Brass nickel-plated / threaded inserts in the lower part: Brass nickel-plated / O-Ring : Viton / Piercing contacts: CuSn6 surface nickel and tin-plated	26	AC2466
	4 inputs / 4 outputs	Active CompactLine module · IR addressing possible · Metal parts from stainless steel · Digital inputs and outputs · Sockets M12 x 1 · PA / socket: stainless steel 316L / 1.4404 / threaded inserts in the lower part: stainless steel 316L / 1.4404 / screws: stainless steel / Piercing contacts: CuSn6 surface nickel and tin-plated / O-Ring : EPDM	26	AC2452
	4 inputs / 4 outputs	Active CompactLine module · IR addressing possible · Version 3.0 with extended addressing mode · Only for operation with AS-i masters with the profile M4 · Digital inputs and outputs · Sockets M12 x 1 · PA / socket: Brass nickel-plated / threaded inserts in the lower part: Brass nickel-plated / O-Ring : Viton / Piercing contacts: CuSn6 surface nickel and tin-plated	26	AC2471
	4 inputs	Active CompactLine module · AS-i connection via M12 connector · Digital inputs · Sockets M12 x 1 · PA / socket: Brass nickel-plated / O-Ring : Viton	27	AC2464
	4 inputs / 4 outputs	Active CompactLine module · AS-i and AUX connection via M12 connector · Digital inputs and outputs · Sockets M12 x 1 · PA / socket: Brass nickel-plated / O-Ring : Viton	28	AC2465
	2 outputs / 2 inputs	Compact M8 AS-i module · 90.5 x 30 x 23.5 · Digital inputs and outputs supplied via AS-i · AS-i connection via M12 connector · Version 2.11 and 3.0 with extended addressing mode · M8 ecolink interface · Sockets M8 x 1 · PBT	29	AC2482
	4 inputs	Compact M8 AS-i module · 90.5 x 30 x 23.5 · Digital inputs · AS-i connection via M12 connector · Version 2.11 and 3.0 with extended addressing mode · M8 ecolink interface · Sockets M8 x 1 · PBT	29	AC2484
	8 inputs	Compact M8 AS-i module · 134.5 x 30 x 23.5 · Digital inputs · AS-i connection via M12 connector · Version 3.0 with extended addressing mode · M8 ecolink interface · Only for operation with AS-i masters with the profile M4 · Sockets M8 x 1 · PBT	30	AC2488

Field modules IP 67 Profibus DP







Type	Inputs / outputs	Description	Draw- ing no.	Order no.
	4 IO-Link ports / 4 digital inputs	I/O modules for field applications · Profibus DP interface · Sockets M12 x 1 · housing: PA 6 / potting compound: PU / Contact pins: Brass gold-plated	31	AC2625
	8 inputs	I/O modules for field applications · Profibus DP interface · Sockets M12 x 1 · housing: PA 6 / potting compound: PU / Contact pins: Brass gold-plated	31	AC2630

Type	Inputs / outputs	Description	Draw- ing no.	Order no.
	4 inputs / 4 outputs	I/O modules for field applications · Profibus DP interface · Sockets M12 x 1 · housing: PA 6 / potting compound: PU / Contact pins: Brass gold-plated	31	AC2631
	4 inputs Pt100	I/O modules for field applications · Profibus DP interface · Sockets M12 x 1 · housing: PA 6 / potting compound: PU / Contact pins: Brass gold-plated	31	AC2634
	4 analogue inputs 0/4...20 mA	I/O modules for field applications · Profibus DP interface · Sockets M12 x 1 · housing: PA 6 / potting compound: PU / Contact pins: Brass gold-plated	31	AC2636
	4 analogue outputs 0/4...20 mA	I/O modules for field applications · Profibus DP interface · Sockets M12 x 1 · housing: PA 6 / potting compound: PU / Contact pins: Brass gold-plated	31	AC2637
	4 analogue inputs -10...0 V / 10 V	I/O modules for field applications · Profibus DP interface · Sockets M12 x 1 · housing: PA 6 / potting compound: PU / Contact pins: Brass gold-plated	31	AC2638

Universal modules AS-Interface

Type	Inputs / outputs	Description	Draw- ing no.	Order no.
	4 inputs	Active module upper part AS-universal module · Digital inputs · Connection via cage clamps · PBT / stainless steel	32	AC2032
	4 inputs / 4 outputs	Active module upper part AS-universal module · Digital inputs and outputs · Connection via cage clamps · PBT / stainless steel	33	AC2035
	2 inputs 4...20 mA	Active AS-i module IP 65 · 2 analogue inputs 4...20 mA · AS-i profile S-7.3 · For the connection of 2-wire, 3-wire or 4-wire sensors · Connection via cage clamps · PBT	34	AC2616
	2 inputs 0...10 V	Active AS-i module IP 65 · 2 analogue inputs 0...10 V · AS-i profile S-7.3 · For the connection of 2-wire, 3-wire or 4-wire sensors · Connection via cage clamps · PBT	34	AC2617
	2 outputs 0...20 mA	Active AS-i module IP 65 · 2 analogue outputs 0...20 mA · AS-i profile S-7.3 · For the connection of 2-wire actuators or 4-wire actuators with separate 24 V supply · Connection via cage clamps · PBT	34	AC2618
	2 outputs 0...10 V	Active AS-i module IP 65 · 2 analogue outputs 0...10 V · AS-i profile S-7.3 · For the connection of 2-wire actuators or 4-wire actuators with separate 24 V supply · Connection via cage clamps · PBT	34	AC2619
	4 inputs Pt100	Active AS-i module IP 65 · 4 analogue inputs temperature Pt100 · AS-i profile S-7.3 · Connection via cage clamps · PBT	33	AC2620

Field modules IP 69K and accessories

Type	Inputs / outputs	Description	Drawing no.	Order no.
	4 inputs / 3 outputs	Active ProcessLine module · Version 2.1 with extended addressing mode · Protection rating IP 69K · high-grade stainless steel · Digital inputs and outputs · Sockets M12 x 1 · high-grade stainless steel / Makrolon / O-ring: EPDM	35	AC2904
	8 digital inputs (2 slaves)	Active ProcessLine module · Version 2.1 with extended addressing mode · Protection rating IP 69K · high-grade stainless steel · Digital inputs · Sockets M12 x 1 · high-grade stainless steel / Makrolon / O-ring: EPDM	36	AC2910
	8-way splitter box	Passive splitter box AS-i ProcessLine · Protection rating IP 69K · high-grade stainless steel · AS-i and AUX splitter box for the connection of intelligent sensors/actuators · Sockets M12 x 1 · high-grade stainless steel / Makrolon	37	AC2900
	4 inputs 4...20 mA	Active AS-i module · 4 analogue inputs 4...20 mA · For the connection of 2-wire and 3-wire sensors · Threaded bush: stainless steel 316L / 1.4404 / Makrolon / O-ring: EPDM	38	AC2916
	4 inputs 4...20 mA	Active AS-i module · 4 analogue inputs 4...20 mA · For the connection of 2-wire, 3-wire or 4-wire sensors · Electrical isolation · Threaded bush: stainless steel 316L / 1.4404 / Makrolon / O-ring: EPDM	38	AC2923
	AS-i / 24 V	FC splitter · V4A · AS-i voltage and external auxiliary voltage via the M12 socket · Metal parts: stainless steel 316L / 1.4404 / Blanks: FPM / O-ring: EPDM	39	E70354
	AS-i	FC splitter · AS-i voltage via M12 socket · Metal parts: stainless steel 316L / 1.4404 / O-ring: EPDM / socket: PP GF30 / blade seal: TPE	40	E70454
	AS-i / 24 V	FC splitter · Metal parts: stainless steel 316L / 1.4404 / Blanks: FPM / O-ring: EPDM	41	E70377



Module lower parts

Type	Inputs / outputs	Description	Drawing no.	Order no.
	FC coupling module	Module lower part flat cable · AS-i interface to module upper part · Quick mounting technology for AS-i flat cable · PBT	42	AC5000
	FC-E coupling module with external power supply	FC-E coupling module · AS-i interface to module upper part · Quick mounting technology for AS-i flat cable · PBT	42	AC5003
	FC coupling module	Module lower part flat cable · with addressing plug · AS-i interface to module upper part · Quick mounting technology for AS-i flat cable · PBT	43	AC5010
	FC-E coupling module with external power supply	FC-E coupling module · with addressing plug · AS-i interface to module upper part · Quick mounting technology for AS-i flat cable · PBT	43	AC5011
	FC coupling module	Module lower part flat cable · stainless steel · AS-i interface to module upper part · Quick mounting technology for AS-i flat cable · PBT / stainless steel	42	AC5014
	FC-E coupling module with external power supply	FC-E coupling module · stainless steel · AS-i interface to module upper part · Quick mounting technology for AS-i flat cable · PBT / stainless steel	42	AC5015

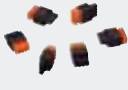
Combicon connectors











Type	Description	Order no.
	Combicon connector · with screw terminals 4-pole · Housing materials: current carrying parts: copper alloy tin-plated	E70230
	Combicon connector · with screw terminals 4-pole · Housing materials: current carrying parts: copper alloy tin-plated	E70231
	Combicon connector · with cage clamps 4 poles · Housing materials: current carrying parts: copper alloy tin-plated	E70232
	Combicon connector · with cage clamps 4 poles · Housing materials: current carrying parts: copper alloy tin-plated	E70233
	Combicon connector · with insulation displacement terminals 4-pole (0.75...1 mm ²) · Housing materials: current carrying parts: copper alloy tin-plated	E70236

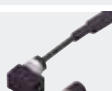
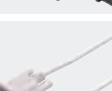



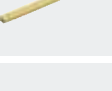

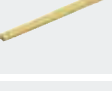
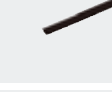

Flat cable splitters and accessories

Type	Description	Order no.
	PAAS M12 · AS-i and external voltage via M12 socket · Sockets M12 x 1 · Housing materials: PA 6.6 / socket housing: stainless steel 316L / 1.4404 / screws: stainless steel 316L / 1.4404 / O-Ring : NBR	E70188
	PAAS splitter box · Distribution of the AS-i voltage or the external 24 V supply · Housing materials: PA / screws: stainless steel 316L / 1.4404 / sealing: NBR	E70200
	FC splitter · Distribution of the AS-i voltage or the external 24 V supply · Housing materials: PA 6 GF35 Grivory	E70381
	FC splitter · high-grade stainless steel · ATEX approval · Group II, category 3D/3G · AS-i voltage and external auxiliary voltage via the M12 socket · Housing materials: Metal parts: stainless steel 316L / 1.4404 / Blanks: FPM / O-ring: EPDM	E7354A
	FC splitter · ATEX approval · Group II, category 3D/3G · Distribution of the AS-i voltage or the external 24 V supply · Housing materials: Metal parts: stainless steel 316L / 1.4404 / Blanks: FPM / O-ring: EPDM	E7377A
	FC insulation displacement connector · Socket M12 - AS-i flat cable · Housing materials: PA 6-GF-FR / Brass nickel-plated	AC5005
	FC insulation displacement connector · Socket M12 - AS-i flat cable · Housing materials: sealing: NBR / housing: PA / O-ring: FPM / screws: stainless steel / nut: stainless steel / Contact pins: bronze gold-plated	E70271
	FC insulation displacement connector · Socket M12 - AS-i flat cable · Housing materials: PA	E70096

Type	Description	Order no.
	FC insulation displacement connector · Distribution of the AS-i voltage and the external 24 V supply to M12 socket · 1 m · Housing materials: housing: PA 6 GF35 Grivory / Socket: PUR	E70481
	FC insulation displacement connector · Distribution of the AS-i voltage to M12 socket · 0.6 m · Housing materials: housing: PA66 - GF25	E70483
	FC insulation displacement connector · Transition from flat cable to round cable · Cable length 2 m · 2 m · Housing materials: PA 6 GF35 Grivory / round cable: PUR / core insulation: PVC	E70498
	FC insulation displacement connector · Transition from flat cable to round cable · Cable length 5 m · 5 m · Housing materials: PA 6 GF35 Grivory / round cable: PUR / core insulation: PVC	E70499
	Flat cable insulation displacement connector	E79995
	FC insulation displacement connector · straight / angled	E79998
	Splitter box · 8 way · Cable · 25 m · Housing materials: high-grade stainless steel	E11847
	Y splitter · M12 plug - 2 M8 sockets · Free from halogen · Free from silicone · Gold-plated contacts · Housing materials: PUR	E10802
	Y splitter · M12 plug - 2 M12 sockets · Free from halogen · Free from silicone · Gold-plated contacts · Housing materials: PUR	E10803
	Protective cap · M8 · for CompactM8 modules · Housing materials: ULTRAMID black	E73005
	Protective cap · M12 · for M12 sockets of ClassicLine modules, CompactLine modules and AirBoxes · Housing materials: PA black	E73004
	Protective cap · M12 · for M12 socket to cover the unused inputs and outputs on the module; for unused inputs of splitter boxes · for ProcessLine modules · Housing materials: PVC	E70297
	Connector for analogue modules · for AC5222, AC5223, AC2516, AC2566 · Housing materials: PVC	E75222

Accessories lower parts and addressing units

Type	Description	Order no.
	AS-i addressing unit · AS-i version 3.0 with extended addressing mode	AC1154
	Addressing cable · for AS-i slaves · 1.6 m	E70213
	Addressing cable	E70423
	Addressing cable · 1 m · black	E70211
	Programming cable for controller E · Western connector RJ11 6 poles / D-Sub socket 9 poles · 1.55 m · grey	E70320
	Screw terminal insert for AC5101/AC5031 for additional 24 V supply	AC5007
	impact protection housing · for ATEX ClassicLine modules and ATEX AirBoxes · Housing materials: housing: stainless steel / button head hexagon socket screw: stainless steel	E7000A
	Use of the lower part as branching box · Housing materials: plastics	AC3000
	AS-i flat cable · Reverse polarity protection due to special shape · for use of insulation displacement technology · 100 m · PUR, halogen-free · yellow	E74100
	AS-i flat cable · Reverse polarity protection due to special shape · for use of insulation displacement technology · 100 m · PUR, halogen-free · black	E74110
	AS-i flat cable · Reverse polarity protection due to special shape · for use of insulation displacement technology · 100 m · EPDM, halogen-free · yellow	E74000
	AS-i flat cable · Reverse polarity protection due to special shape · for use of insulation displacement technology · 100 m · EPDM, halogen-free · black	E74010
	AS-i flat cable · Reverse polarity protection due to special shape · for use of insulation displacement technology · 100 m · TPE · yellow	E74200
	AS-i flat cable · Reverse polarity protection due to special shape · for use of insulation displacement technology · 100 m · TPE · black	E74210

Type	Description	Order no.
	AS-i flat cable · Reverse polarity protection due to special shape · for the food industry · for use of insulation displacement technology · 100 m · TPE-PVC compound · yellow	E74300
	AS-i flat cable · Reverse polarity protection due to special shape · for the food industry · for use of insulation displacement technology · 100 m · TPE-PVC compound · black	E74310
	JOKARI flat cable stripping tool	E70062
	Flat cable blank · Length: 60 mm · to cover the unused cable entry · for FC splitter E70354 · Housing materials: silicone rubber blue	E70299
	Flat cable blank · Length: 60 mm · to cover the unused cable entry · for CompactLine modules (AC24xx), ClassicLine modules (AC52xx) or AirBoxes (AC52xx) · Housing materials: EPDM black	E70399
	Heat-shrink cap · for sealing the flat cable ends · Housing materials: plastics	E70113
	Flat cable seal · Housing materials: ULTRAMID / sealing: NBR	E70413
	Cable clip for fixing the AS-i flat cable · for AC4000 / AC4002 · Housing materials: PA 6.6	E70067
	Torque wrench	E70390

Scale drawings / drawing no. – CAD download: www.ifm.com

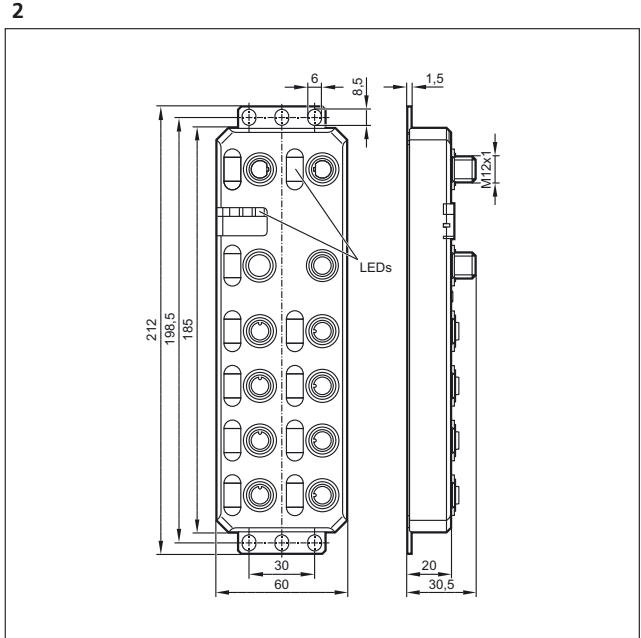
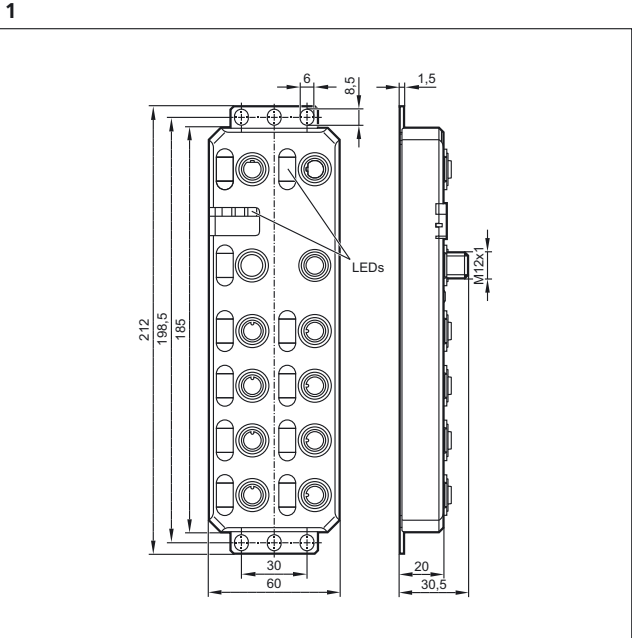

Scale drawings / drawing no. – CAD download: www.ifm.com

3

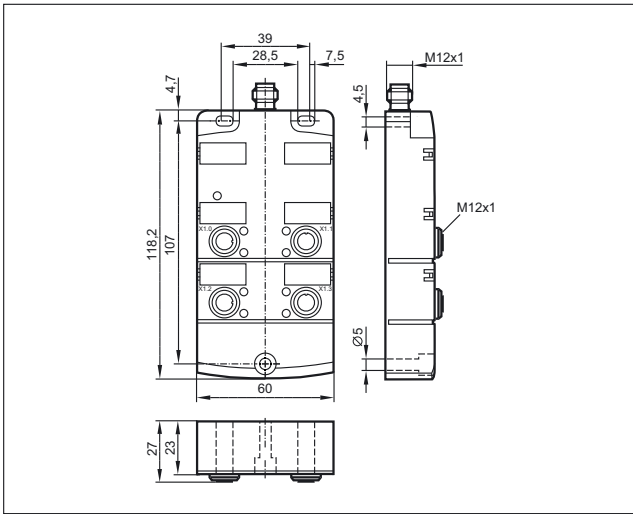

4

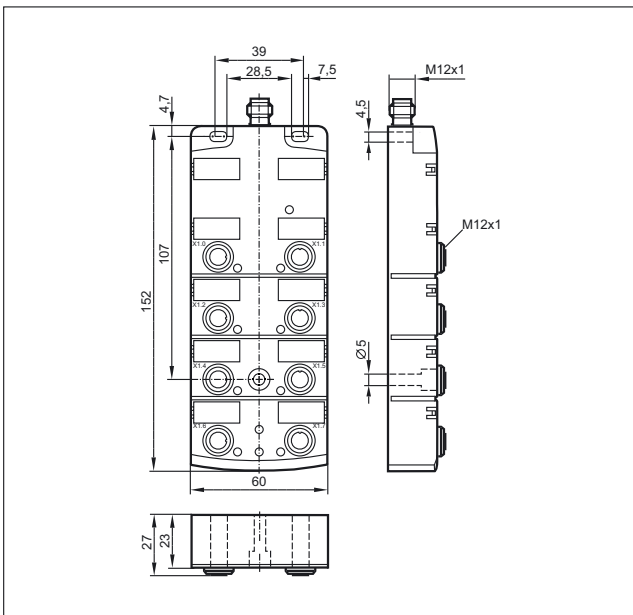

5

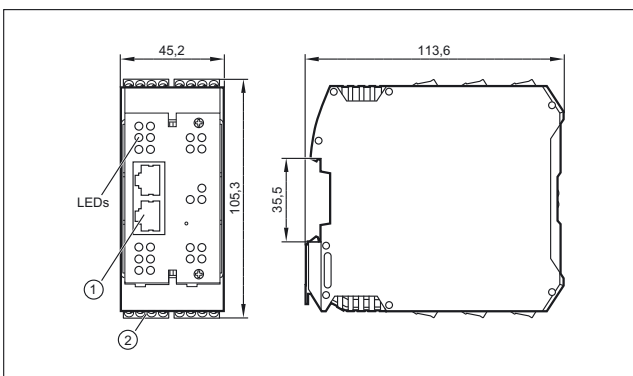

1: Ethernet interface, 2: screw terminals

6

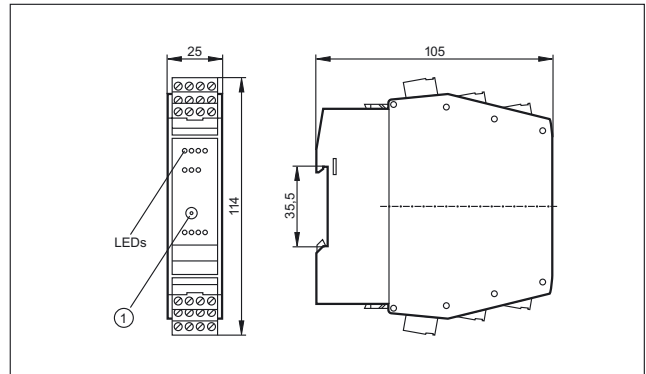

1: Addressing socket

7

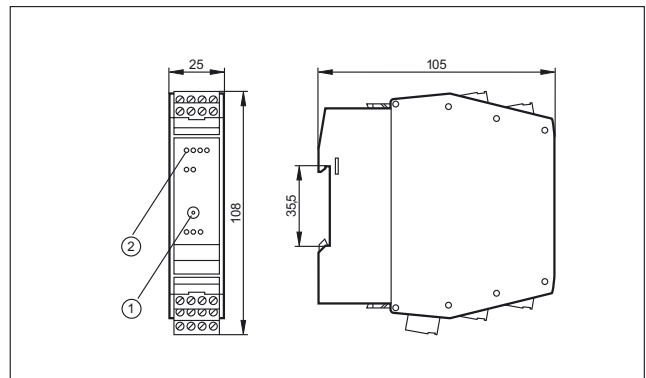

1: Addressing socket, 2: LED

8

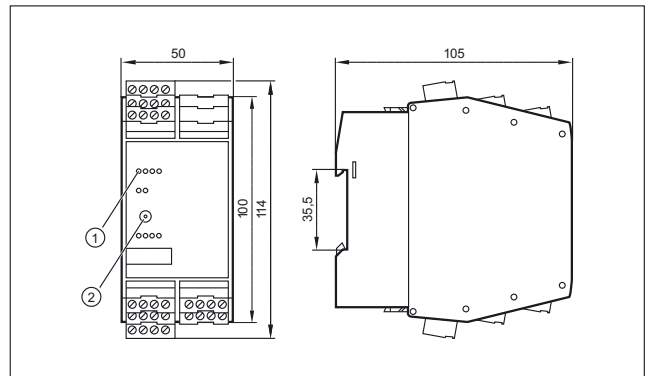

1: LED, 2: Addressing socket

9

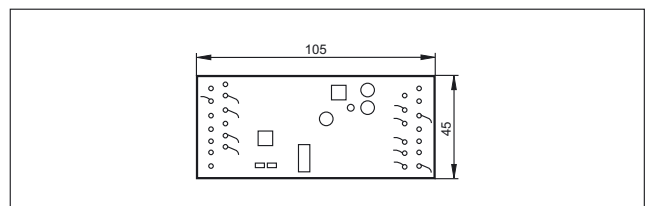

Scale drawings / drawing no. – CAD download: www.ifm.com

10

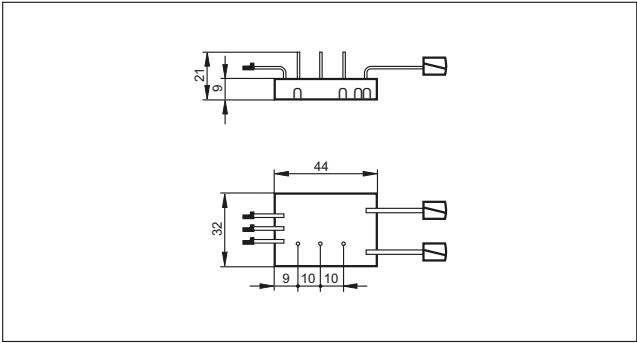

11

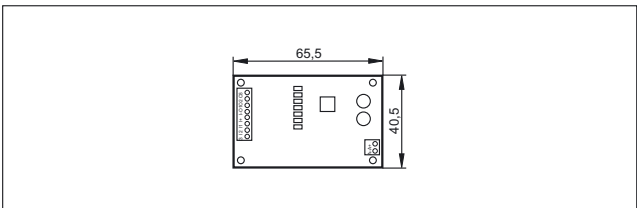

12

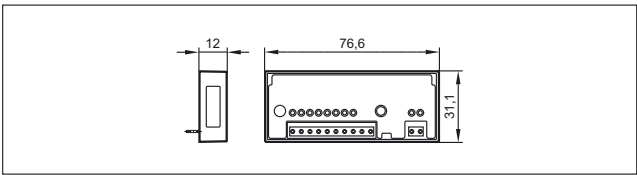

13

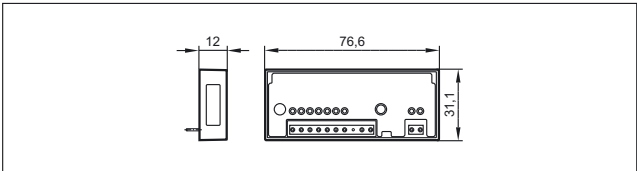

14

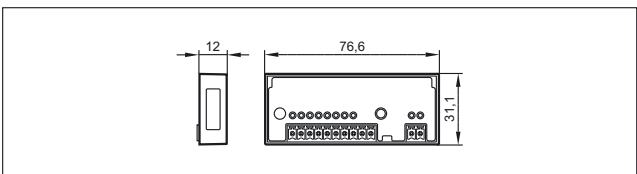

15

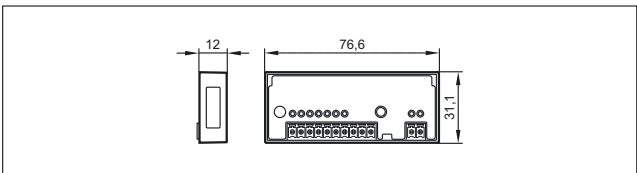

16

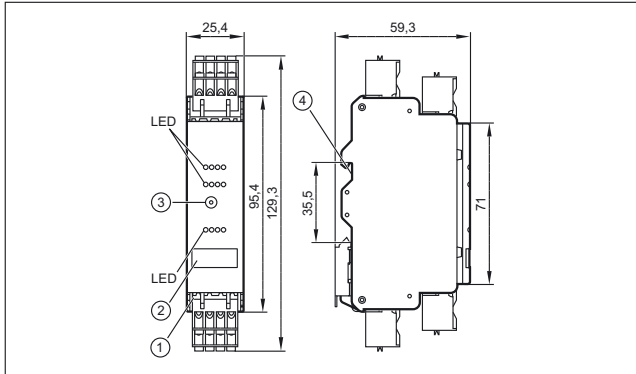

1: Plug with cage clamp connection, 2: label, 3: Addressing socket, 4: DIN rail adapter

17

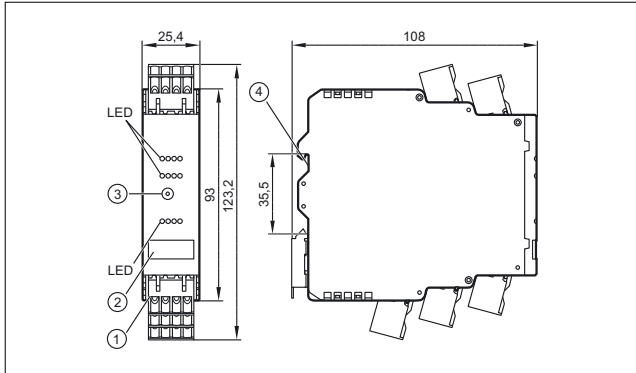

1: Plug with cage clamp connection, 2: label, 3: Addressing socket, 4: Mounting on DIN rail

18

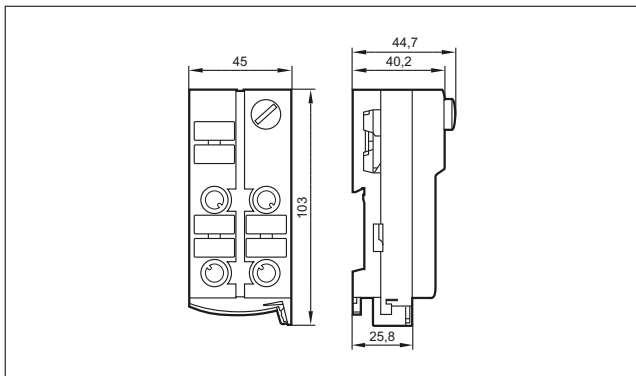

19

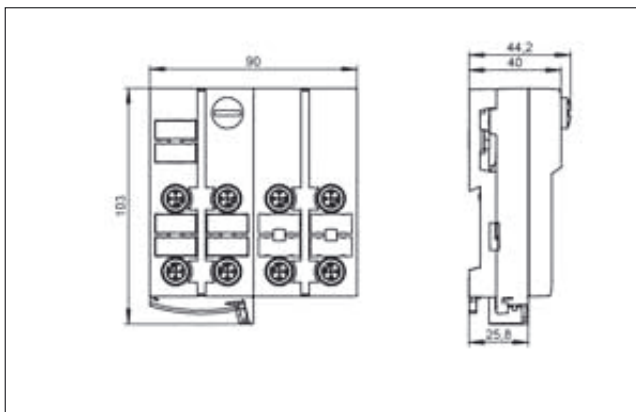

Scale drawings / drawing no. – CAD download: www.ifm.com

20

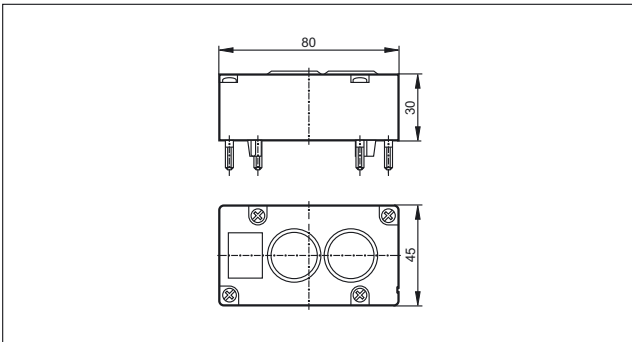

21

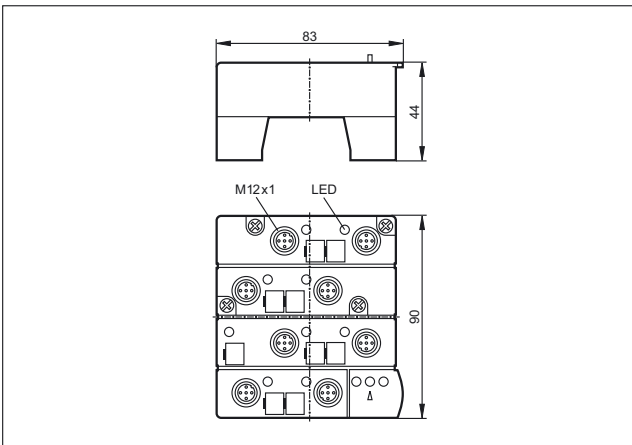

22

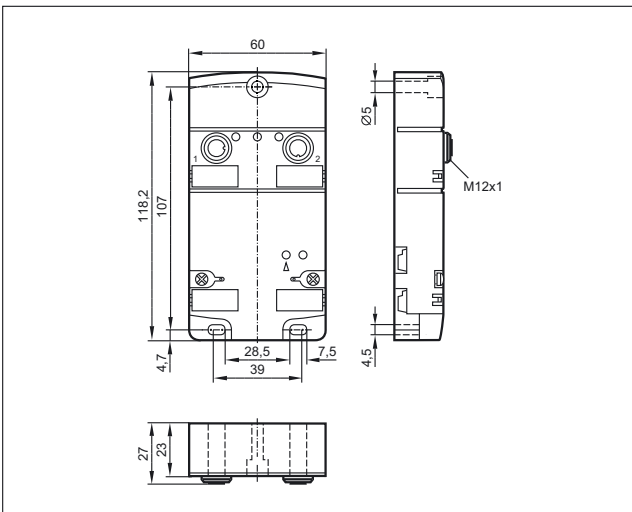

23

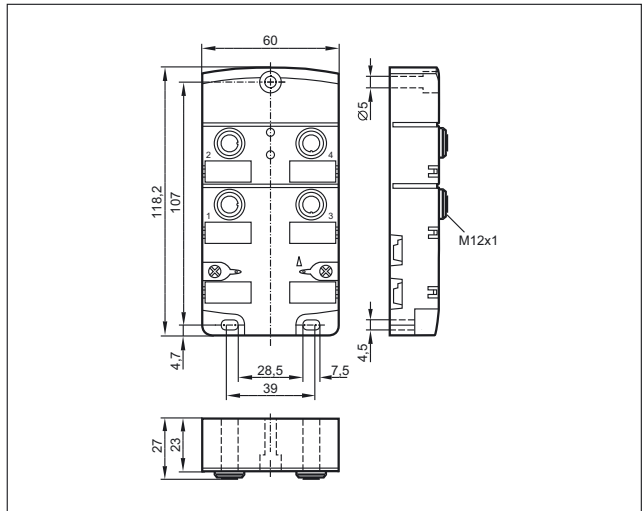

24

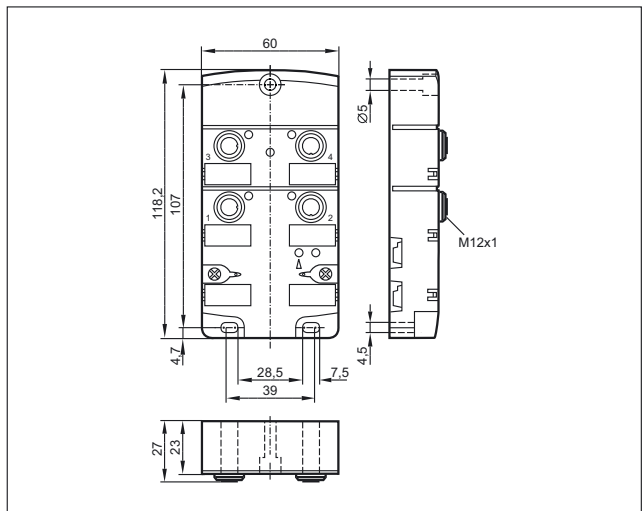

25

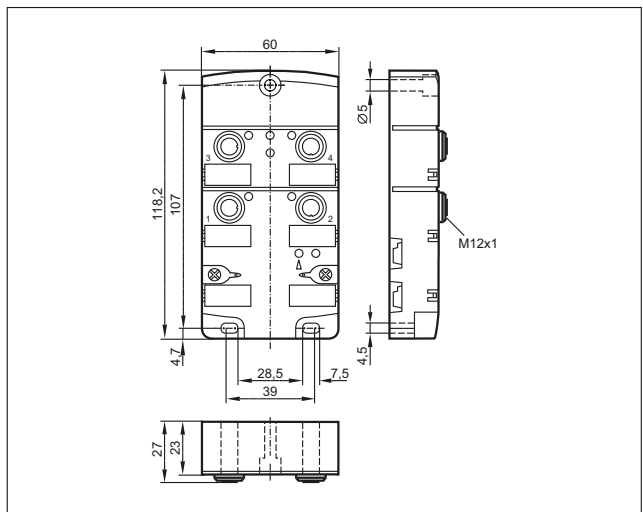

Scale drawings / drawing no. – CAD download: www.ifm.com

26

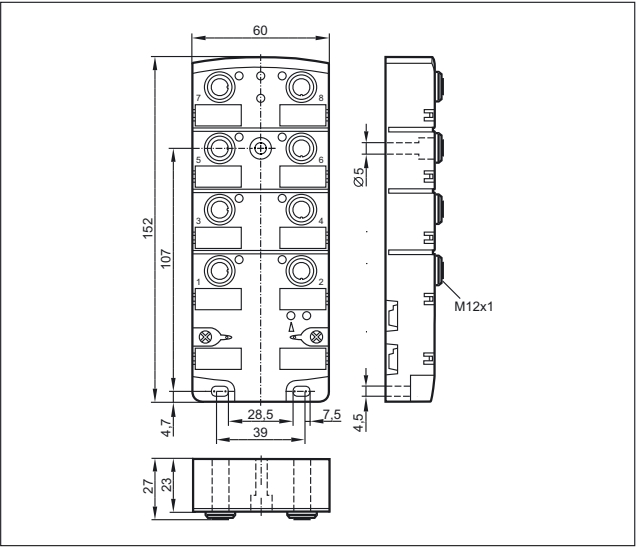

29

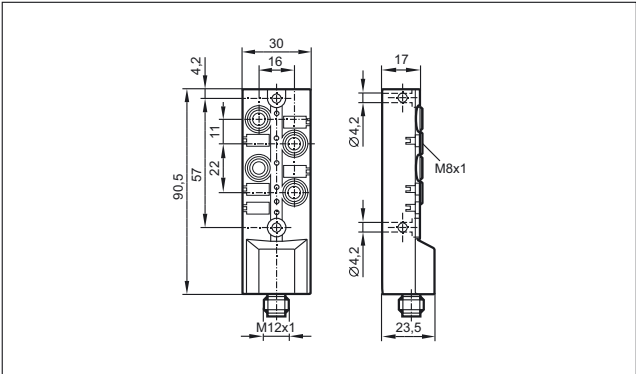

30

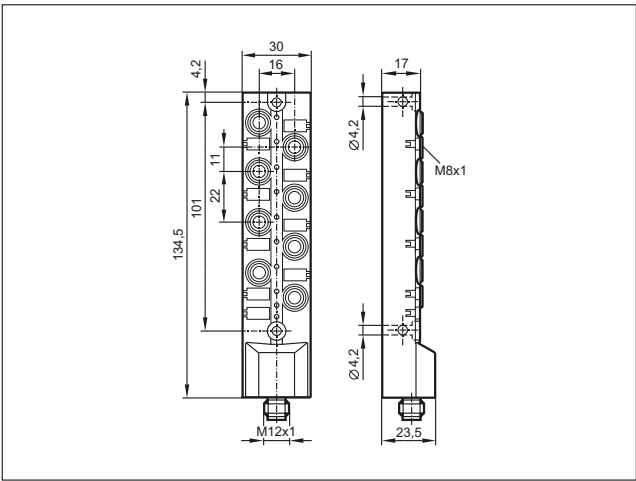

27

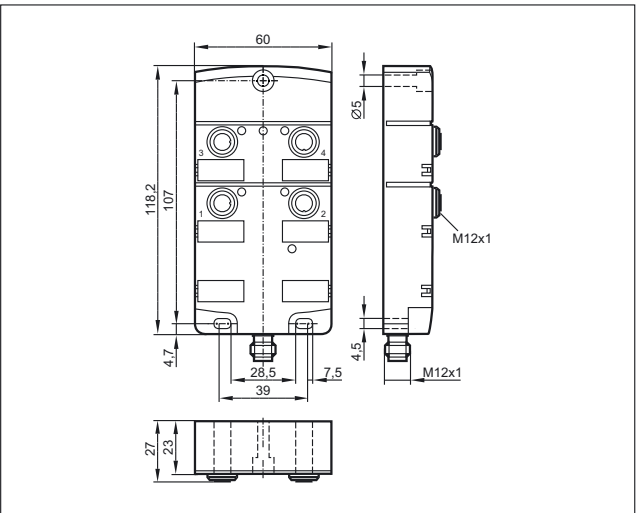

31

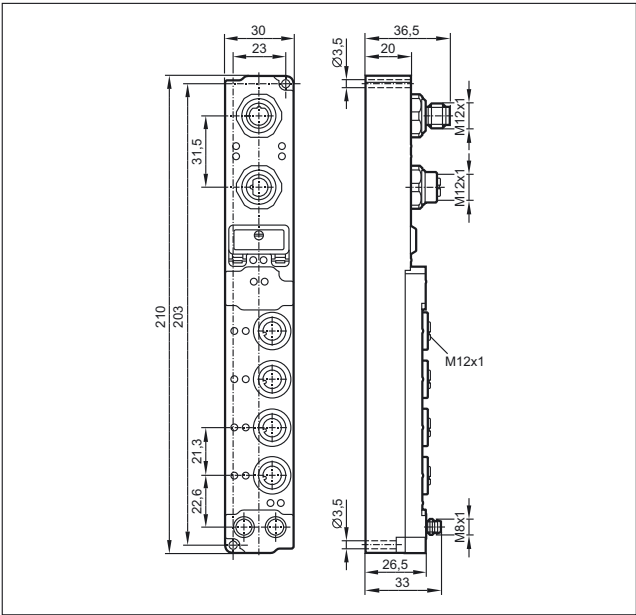

28

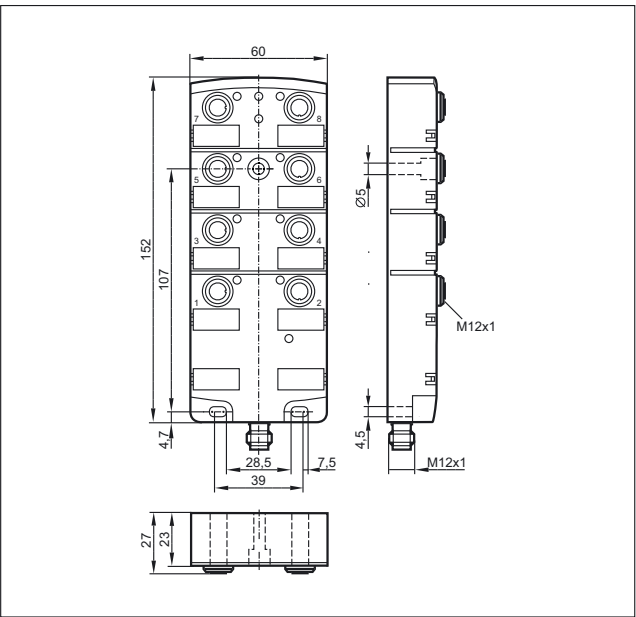

32

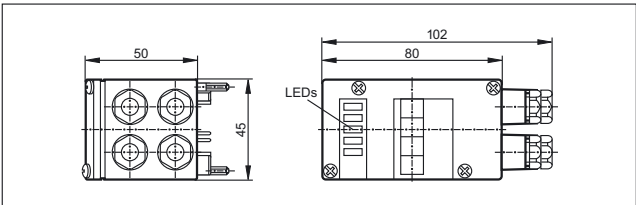

Scale drawings / drawing no. – CAD download: www.ifm.com

33

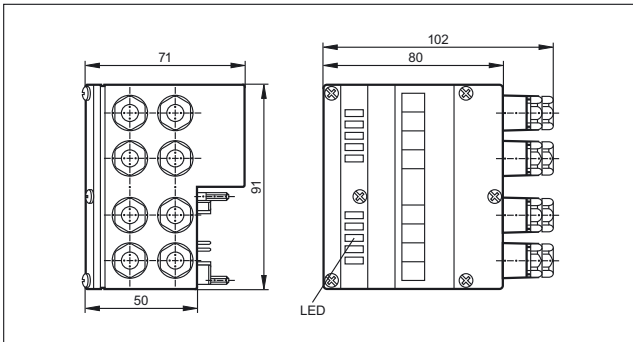

38

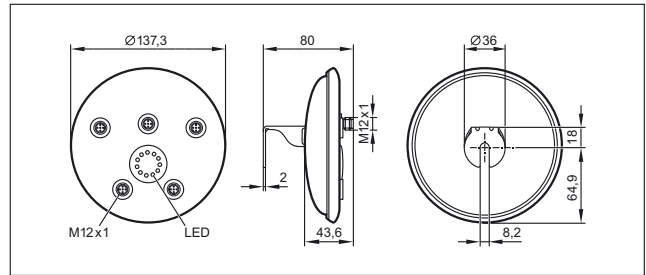

34

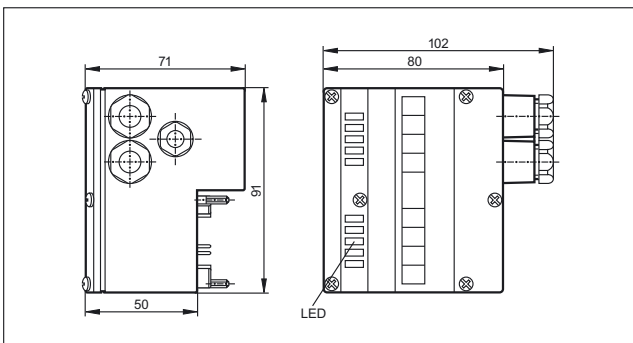

39

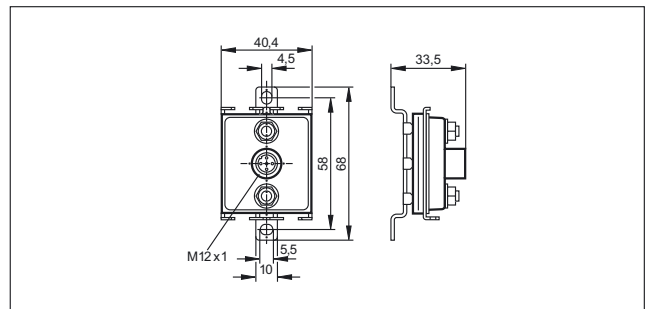

35

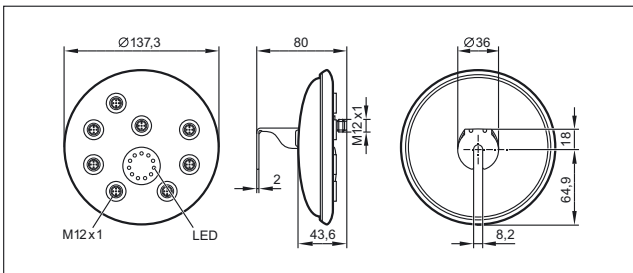

40

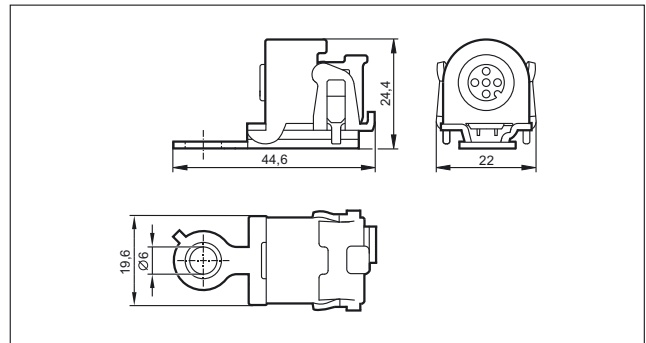

36

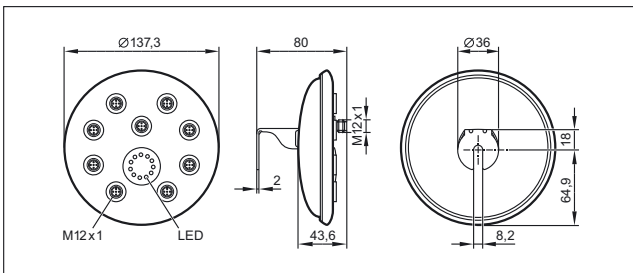

41

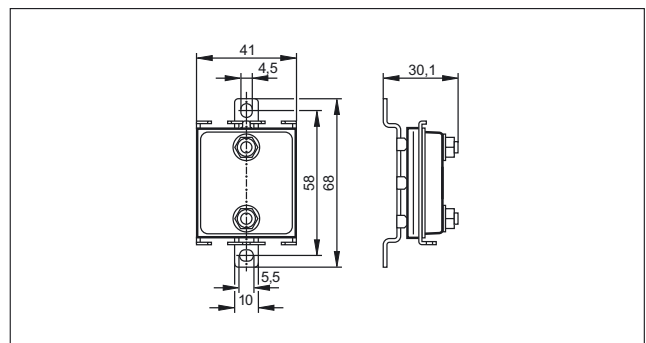

37

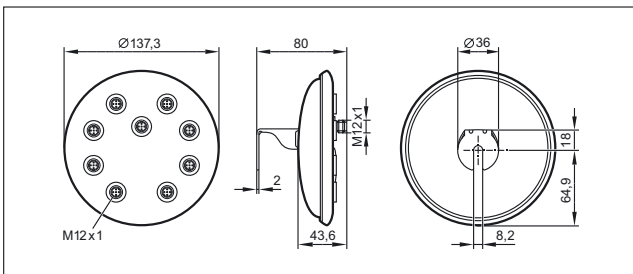

42

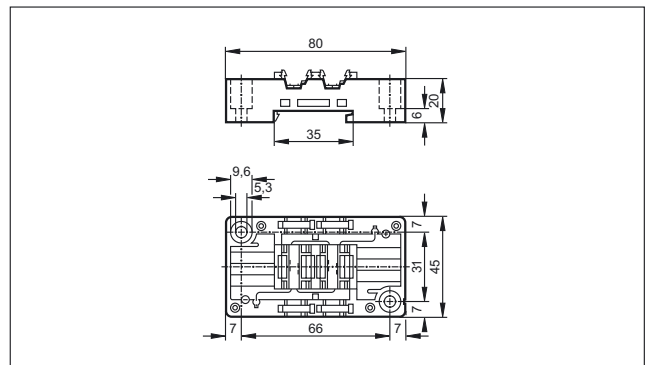

Scale drawings / drawing no. – CAD download: www.ifm.com

43

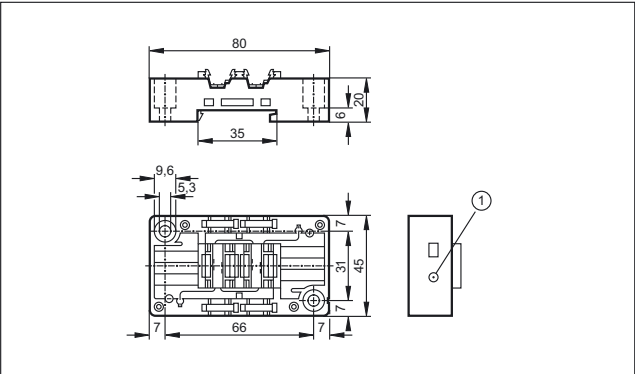

1: Addressing socket





AS-Interface AirBoxes for pneumatics

The AS-i AirBoxes are compact pneumatic valves, complemented by digital feedback inputs. They are integrated in a ClassicLine housing and are compatible in terms of space and mounting. The AS-i connection is carried out via the common flat cable or round cable lower parts. 3/2-way, 4/2-way, 5/2-way and 5/3-way valves are available.

System overview	Page
Pneumatic solutions (quick mounting)	614 - 615
Pneumatic solutions (ATEX)	615
Pneumatic solutions (screw mounting)	616
Accessories pneumatic components	616
Scale drawings / drawing no. – CAD download: www.ifm.com	617

Pneumatic solutions (quick mounting)

Type	Inputs / outputs	Description	Draw- ing no.	Order no.
	2 inputs / 2 outputs; AirBox supply via AS-i	AS-i AirBox · 2 x 3/2-way slide valves free from overlapping · monostable · Three orientations of the flat cable are possible · AS-i flat cable connection · Addressing socket · AS-i profile S-3.F.F · PA / POM / Piercing contacts: CuSn6 surface nickel and tin-plated	1	AC5227
	4 inputs / 2 outputs; AirBox supply via AS-i	AS-i AirBox · 2 x 3/2-way slide valves free from overlapping · monostable · Three orientations of the flat cable are possible · AS-i flat cable connection · Version 2.11 and 3.0 with extended addressing mode · Addressing socket · PA / POM / Piercing contacts: CuSn6 surface nickel and tin-plated	1	AC5228
	4 inputs / 2 outputs; AirBox supply via external 24 V DC	AS-i AirBox · 2 x 3/2-way slide valves free from overlapping · monostable · Three orientations of the flat cable are possible · AS-i flat cable connection · Version 2.11 and 3.0 with extended addressing mode · Addressing socket · PA / POM / Piercing contacts: CuSn6 surface nickel and tin-plated	1	AC5243
	4 inputs / 1 output; AirBox supply via AS-i	AS-i AirBox · 5/2-way slide valve free from overlapping · monostable · Three orientations of the flat cable are possible · AS-i flat cable connection · Version 2.11 and 3.0 with extended addressing mode · Addressing socket · PA / POM / Piercing contacts: CuSn6 surface nickel and tin-plated	2	AC5246
	4 inputs / 1 output; AirBox supply via external voltage 24 V DC	AS-i AirBox · 5/2-way slide valve free from overlapping · monostable · Three orientations of the flat cable are possible · AS-i flat cable connection · Version 2.11 and 3.0 with extended addressing mode · Addressing socket · PA / POM / Piercing contacts: CuSn6 surface nickel and tin-plated	2	AC5249
	4 inputs / 2 outputs; AirBox supply via AS-i	AS-i AirBox · 5/2-way bistable slide valve free from overlapping · Three orientations of the flat cable are possible · AS-i flat cable connection · Version 2.11 and 3.0 with extended addressing mode · Addressing socket · PA / POM / Piercing contacts: CuSn6 surface nickel and tin-plated	1	AC5251

Type	Inputs / outputs	Description	Draw- ing no.	Order no.
	4 inputs / 2 outputs; AirBox supply via external 24 V DC	AS-i AirBox · 5/2-way bistable slide valve free from overlapping · Three orientations of the flat cable are possible · AS-i flat cable connection · Version 2.11 and 3.0 with extended addressing mode · Addressing socket · PA / POM / Piercing contacts: CuSn6 surface nickel and tin-plated	1	AC5253
	4 inputs / 2 outputs; AirBox supply via AS-i	AS-i AirBox · 5/3-way slide valve free from overlapping · closed · Three orientations of the flat cable are possible · AS-i flat cable connection · Version 2.11 and 3.0 with extended addressing mode · Addressing socket · PA / POM / Piercing contacts: CuSn6 surface nickel and tin-plated	1	AC5270
	4 inputs / 2 outputs; AirBox supply via external 24 V DC	AS-i AirBox · 5/3-way slide valve free from overlapping · closed · Three orientations of the flat cable are possible · AS-i flat cable connection · Addressing socket · Version 2.11 and 3.0 with extended addressing mode · PA / POM / Piercing contacts: CuSn6 surface nickel and tin-plated	1	AC5271

Pneumatic solutions (ATEX)

Type	Inputs / outputs	Description	Draw- ing no.	Order no.
	4 inputs / 2 outputs; AirBox supply via AS-i	AS-i AirBox · 2 x 3/2-way slide valves free from overlapping · monostable · Three orientations of the flat cable are possible · Digital inputs · Addressing socket · AS-i profile S-7.F.F · Versions 2.11 and 3.0 · ATEX approval · Group II, category 3D · Only in conjunction with impact protection housing E7000A or equivalent protection · PA / POM / Piercing contacts: CuSn6 surface nickel and tin-plated	1	AC542A
	4 inputs / 2 outputs; AirBox supply via AS-i	AS-i AirBox · 2 x 3/2-way slide valves free from overlapping · Three orientations of the flat cable are possible · AS-i flat cable connection · Version 2.11 and 3.0 with extended addressing mode · Addressing socket · ATEX approval · Group II, category 3D · Only in conjunction with impact protection housing E7000A or equivalent protection · PA / POM / Piercing contacts: CuSn6 surface nickel and tin-plated	1	AC528A
	4 inputs / 1 output ; AirBox supply via AS-i	AS-i AirBox · 5/2-way slide valve free from overlapping · monostable · Three orientations of the flat cable are possible · AS-i flat cable connection · Version 2.11 and 3.0 with extended addressing mode · Addressing socket · ATEX approval · Group II, category 3D · Only in conjunction with impact protection housing E7000A or equivalent protection · PA / POM / Piercing contacts: CuSn6 surface nickel and tin-plated	2	AC546A
	2 inputs / 1 output; AirBox supply via AS-i	AS-i AirBox · 5/2-way slide valve free from overlapping · monostable · Three orientations of the flat cable are possible · Digital inputs · Addressing socket · AS-i profile S-3.F.F · ATEX approval · Group II, category 3D · Only in conjunction with impact protection housing E7000A or equivalent protection · PA / POM / Piercing contacts: CuSn6 surface nickel and tin-plated	1	AC246A
	4 inputs / 2 outputs; AirBox supply via AS-i	AS-i AirBox · 5/2-way bistable slide valve free from overlapping · Three orientations of the flat cable are possible · AS-i flat cable connection · Version 2.11 and 3.0 with extended addressing mode · Addressing socket · ATEX approval · Group II, category 3D · Only in conjunction with impact protection housing E7000A or equivalent protection · PA / POM / Piercing contacts: CuSn6 surface nickel and tin-plated	1	AC551A
	4 inputs / 2 outputs; AirBox supply via AS-i	AS-i AirBox · 5/3-way slide valve free from overlapping · closed · Three orientations of the flat cable are possible · AS-i flat cable connection · Version 2.11 and 3.0 with extended addressing mode · Addressing socket · ATEX approval · Group II, category 3D · Only in conjunction with impact protection housing E7000A or equivalent protection · PA / POM / Piercing contacts: CuSn6 surface nickel and tin-plated	1	AC570A

Pneumatic solutions (screw mounting)

Type	Inputs / outputs	Description	Draw- ing no.	Order no.
	2 x 2 inputs / 2 outputs	AS-i AirBox · Connection to the pneumatic system by tube fittings · Manual override by pressing/releasing or pressing/turning/locking · 2 x 2 digital inputs · 2 pneumatic outputs · Sockets M12 x 1 · housing: PBT / Metal parts: stainless steel / sealing: Viton	3	AC2055
	2 inputs / 1 output NO/NC selectable (monostable)	AS-i AirBox · Connection to the pneumatic system by tube fittings · 1 x 2 or 2 x 1 digital inputs · 1 pneumatic output (NO/NC selectable) · Sockets M12 x 1 · housing: PBT / Metal parts: stainless steel / sealing: Viton	4	AC2057

Accessories pneumatic components

Type	Description	Order no.
	Silencer · Housing materials: connection piece: PP / filter: PE	E75232
	Push-in T-fitting · Housing materials: housing: Nickel-plated brass / PA66 / tooth lock washer: stainless steel	E75227
	Push-in L-fitting · Housing materials: housing: PA66 / release ring: polyoxymethylene / tooth lock washer: stainless steel / form ring: acrylonitrile butadiene caoutchouc	E75228
	Push-in L-fitting · Diameter reduction from Ø8 mm to Ø6 mm · Housing materials: housing: Nickel-plated brass / PA66 / tooth lock washer: stainless steel	E75229
	Sealing plug for AirBox · Housing materials: housing: PA66	E75231

Scale drawings / drawing no. – CAD download: www.ifm.com

1

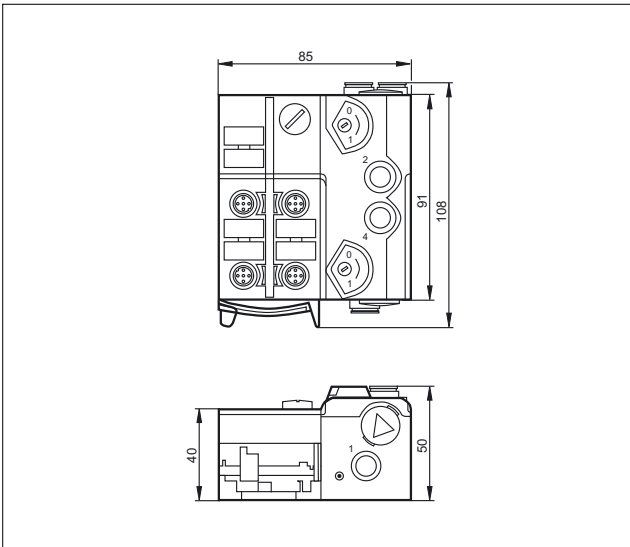

2

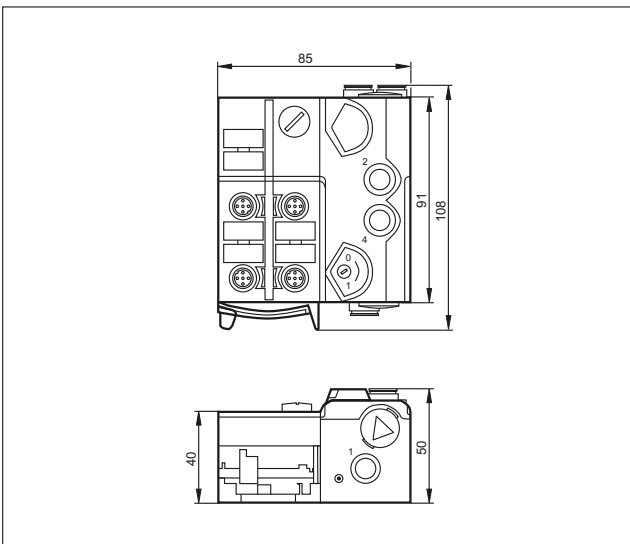

3

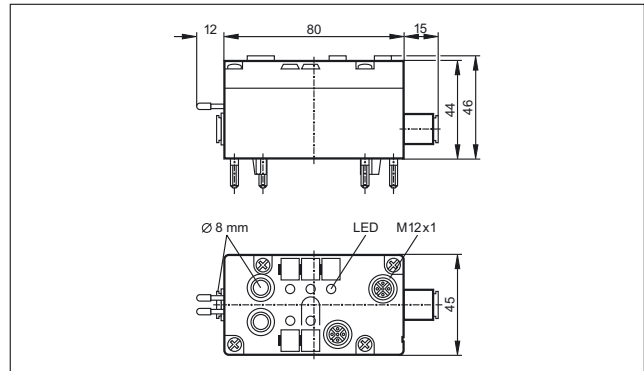

4

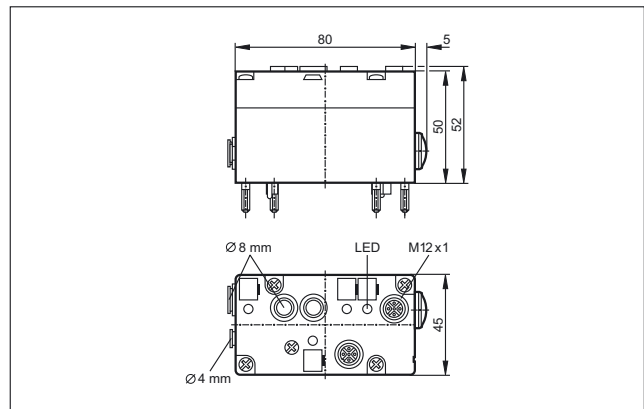















AS-Interface sensors

The bus connection is already integrated in the intelligent AS-i sensors. So they can be directly connected to the yellow cable. In addition to the pure sensor information, further diagnostic data are available via the AS-interface, which can be transmitted and evaluated at a low cost.

System overview	Page
AS-i sensors	618 - 619
Scale drawings / drawing no. – CAD download: www.ifm.com	619 - 620

AS-i sensors

Type	Description	Draw- ing no.	Order no.
	Inductive sensor · M12 x 1 · Sensing range 4 mm · Gold-plated contacts · Connector, Gold-plated contacts · stainless steel / active face: LCP uncoloured	1	IFC247
	Inductive sensor · M12 x 1 · Sensing range 7 mm · Gold-plated contacts · Connector, Gold-plated contacts · stainless steel / active face: LCP uncoloured	2	IFC248
	Inductive sensor · M18 x 1 · Sensing range 8 mm · Gold-plated contacts · Connector, Gold-plated contacts · threaded sleeve: stainless steel / active face: LCP uncoloured / lock nuts: Brass	3	IGC234
	Inductive sensor · M18 x 1 · Sensing range 12 mm · Gold-plated contacts · Connector, Gold-plated contacts · threaded sleeve: stainless steel / active face: LCP uncoloured / lock nuts: Brass	4	IGC235
	Inductive sensor · M30 x 1.5 · Sensing range 14 mm · Gold-plated contacts · Connector, Gold-plated contacts · stainless steel / active face: LCP uncoloured	5	IIC220
	Inductive sensor · M30 x 1.5 · Sensing range 22 mm · Gold-plated contacts · Connector, Gold-plated contacts · stainless steel / active face: LCP uncoloured	6	IIC221
	Inductive sensor · Sensing range 15 mm · 5 positions of the sensing face selectable · Connector, rotatable, locking · PBT / PPE	7	IM5118
	Temperature transmitter · Analogue value (16 bit value incl. sign) · AS-i profile S-7.3 · Max. medium temperature · 150°C / 302°F (max. 40 min.) · Connector, Gold-plated contacts · stainless steel 316L / 1.4404 / stainless steel / stainless steel / PA	8	TAA131
	Temperature transmitter · Analogue value (16 bit value incl. sign) · AS-i profile S-7.3 · Max. medium temperature · 150°C / 302°F (max. 40 min.) · Connector, Gold-plated contacts · stainless steel 316L / 1.4404 / stainless steel / stainless steel / PA	9	TAA431

Type	Description	Draw- ing no.	Order no.
	Read/write head · With integrated AS-i slave profile 7.4 · M12 connector · rotatable · PA	10	DTA100
	Read head · with integrated AS-i slave profile 7.3 · M12 connector · rotatable · PA	10	DTA101
	Read/write head · With integrated AS-i slave profile 7.4 · M12 connector · 5 positions of the sensing face selectable · rotatable, locking · PA	7	DTA200
	Read head · with integrated AS-i slave profile 7.3 · M12 connector · 5 positions of the sensing face selectable · rotatable, locking · PA	7	DTA201
	Read/write head · With integrated AS-i slave profile 7.4 · M12 connector · rotatable · housing: PPE / Metal parts: diecast zinc / brass nickel-plated	11	DTA300
	Read head · with integrated AS-i slave profile 7.3 · M12 connector · rotatable · housing: PPE / Metal parts: diecast zinc / brass nickel-plated	11	DTA301

Scale drawings / drawing no. – CAD download: www.ifm.com

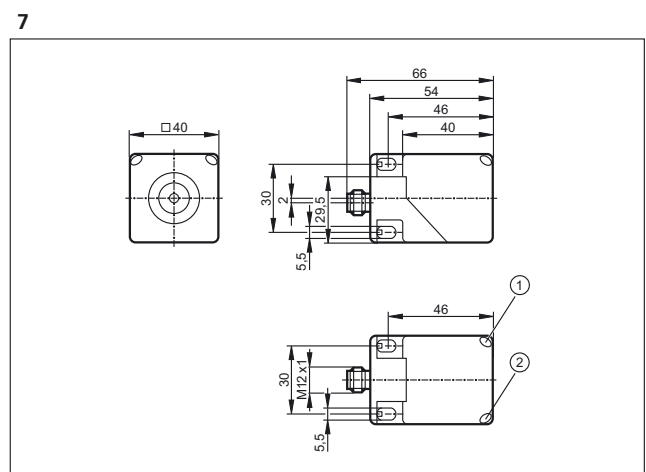
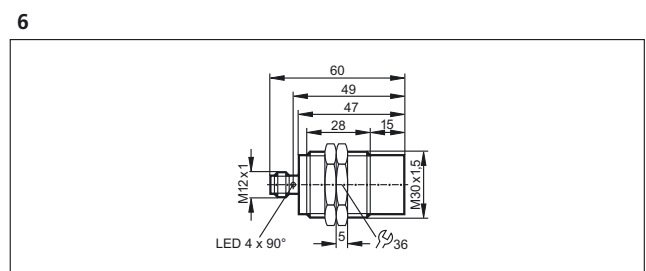
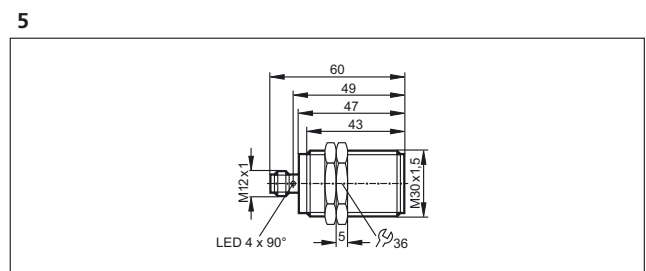
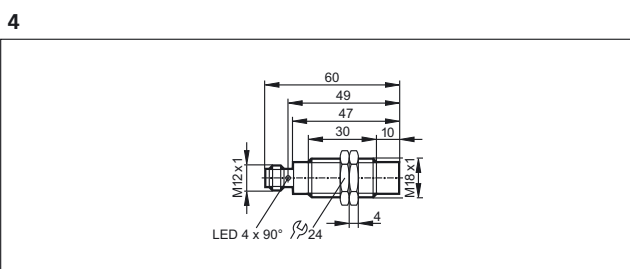
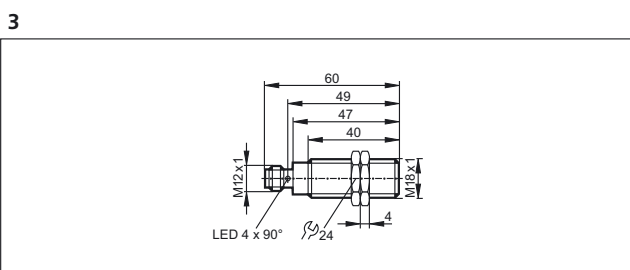
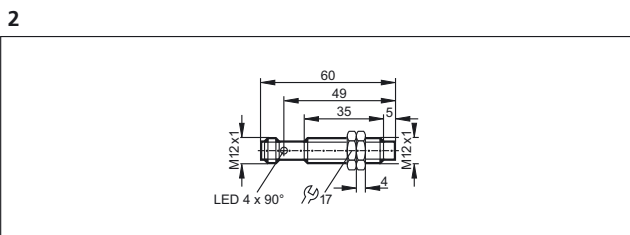
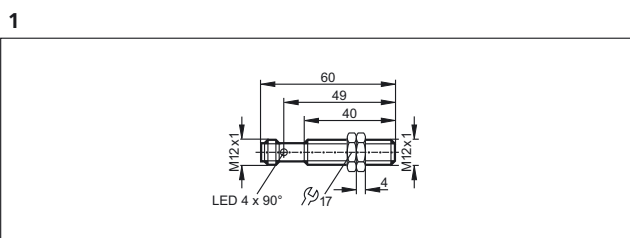

1: LED yellow, 2: LED green

Scale drawings / drawing no. – CAD download: www.ifm.com

8

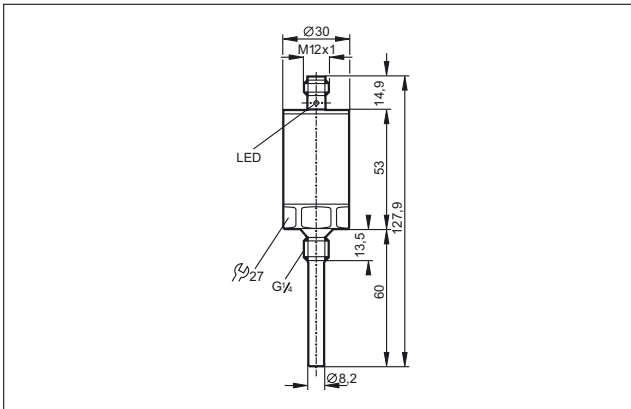

9

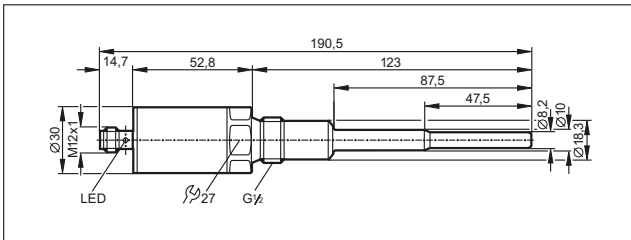

10

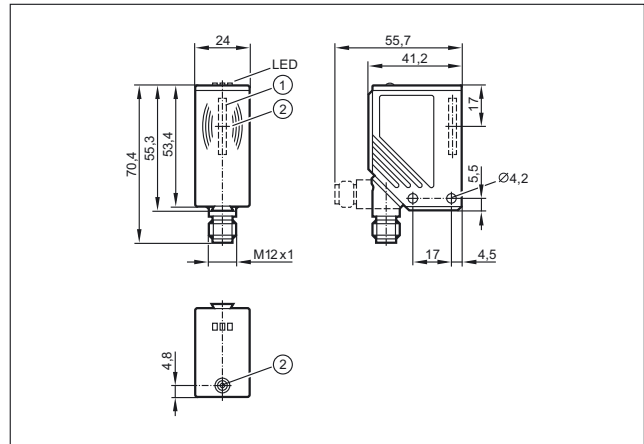

1: integrated antenna, 2: tag positioning mark (middle of the antenna)

11

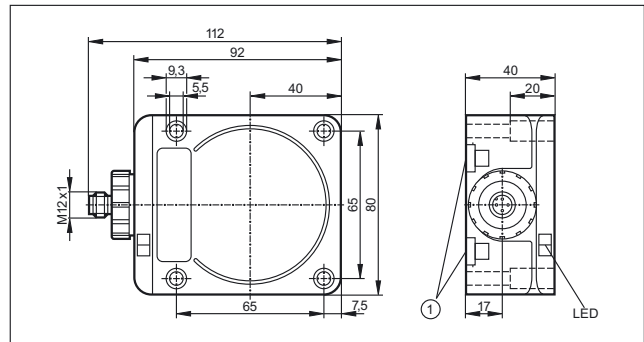

1: Mounting on DIN rail





AS-Interface devices for valves and valve actuators

The valve controls for pneumatic quarter-turn actuators can be directly mounted to most quarter-turn actuators by means of the standardised mechanical interface. They contain two inductive sensors for position feedback, one or two outputs for the control of the pilot valve, and an AS-i slave.

System overview	Page
Sensors with ATEX approval 3D and / or 3G	622
Sensors for industrial applications, AS-i system	622 - 623
Wiring diagrams	623
Scale drawings / drawing no. – CAD download: www.ifm.com	623 - 624

Sensors with ATEX approval 3D and / or 3G

Type	Dimensions [mm]	Sensing range [mm]	Material	U _b [V]	Protection	f AC / DC [Hz]	I _{load} AC / DC [mA]	Draw- ing no.	Order no.
------	--------------------	-----------------------	----------	-----------------------	------------	----------------------	--------------------------------------	---------------------	--------------

M12 connector · Output function transistor PNP · 2 inputs / 2 outputs · Connector groups 154, 156

	55 x 60 x 35	4	PBT	26.5...31.6	IP 5x	–	–	1	AC327A
---	--------------	---	-----	-------------	-------	---	---	---	--------

M12 connector · Output function transistor PNP · 2 inputs / 1 output · Connector groups 154, 156

	55 x 60 x 35	4	PBT	26.5...31.6	IP 5x	–	–	1	AC336A
---	--------------	---	-----	-------------	-------	---	---	---	--------

Sensors for industrial applications, AS-i system

Type	Dimensions [mm]	Sensing range [mm]	Material	U _b [V]	Protection	f AC / DC [Hz]	I _{load} AC / DC [mA]	Draw- ing no.	Order no.
------	--------------------	-----------------------	----------	-----------------------	------------	----------------------	--------------------------------------	---------------------	--------------

M12 connector · Output function transistor PNP · 2 inputs / 1 output · Connector group --

	55 x 60 x 35	4 nf	PBT (Pocan)	26.5...31.6	IP 67	–	–	2	AC2310
---	--------------	------	-------------	-------------	-------	---	---	---	--------

Type	Dimensions [mm]	Sensing range [mm]	Material	U _b [V]	Protection	f AC / DC [Hz]	I _{load} AC / DC [mA]	Drawing no.	Order no.
------	--------------------	--------------------------	----------	-----------------------	------------	----------------------	--------------------------------------	----------------	--------------

M12 connector · 1 x 2 inputs · Wiring diagram no. 1 · Connector groups 10, 12, 13, 18, 19, 20, 21, 120, 122, 124, 126, 128, 132, 157, 159

	55 x 60 x 35	4 nf	PBT (Pocan)	26.5...31.6	IP 67	-	-	3	AC2315
---	--------------	------	-------------	-------------	-------	---	---	---	--------

M12 connector · Output function transistor PNP · 2 inputs / 1 output · Connector groups 8, 10, 18, 20, 40, 120, 124, 126, 128, 135, 136, 157

	55 x 60 x 35	4 nf	PBT (Pocan)	26.5...31.6	IP 67	-	-	2	AC2316
---	--------------	------	-------------	-------------	-------	---	---	---	--------

M12 connector · Output function transistor PNP · 2 inputs / 2 outputs · Connector groups 8, 10, 18, 20, 40, 120, 124, 126, 128, 135, 136, 157

	55 x 60 x 35	4 nf	PBT (Pocan)	26.5...31.6	IP 67	-	-	2	AC2317
---	--------------	------	-------------	-------------	-------	---	---	---	--------

f = flush / nf = non flush

Wiring diagrams

1

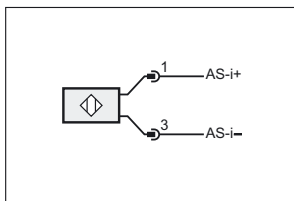

Scale drawings / drawing no. – CAD download: www.ifm.com

1

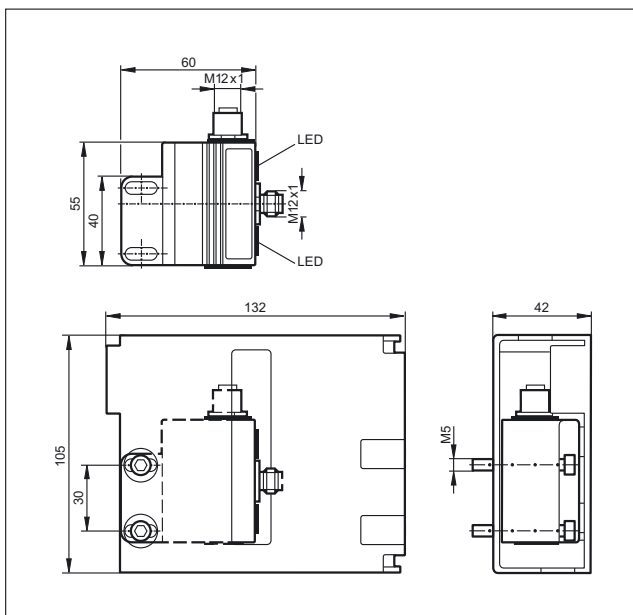

2

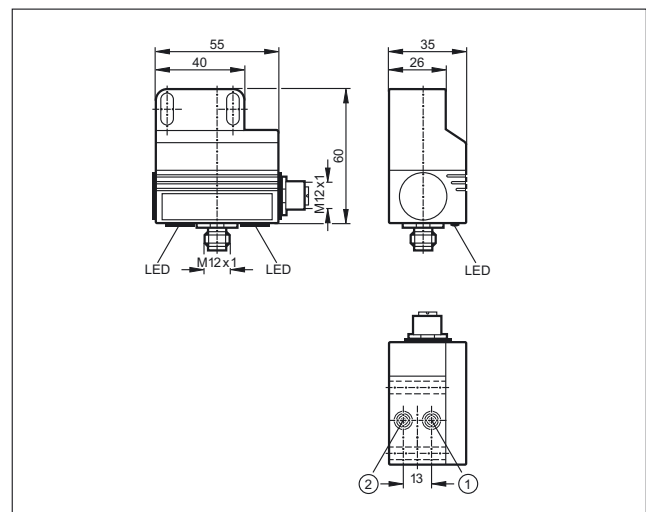

1: sensor 1, 2: sensor 2

Scale drawings / drawing no. – CAD download: www.ifm.com

3

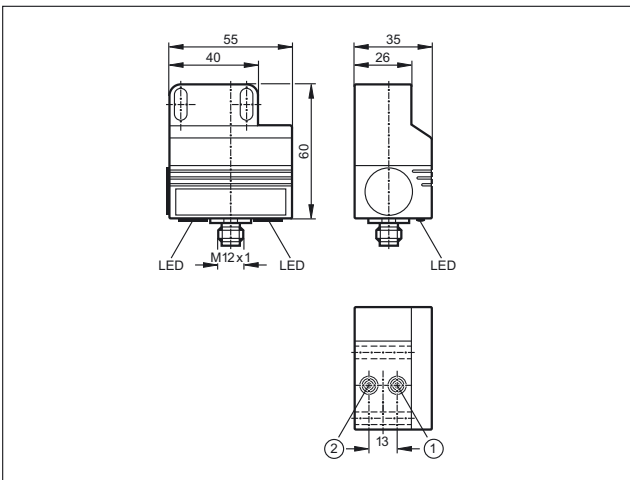

1: sensor 1, 2: sensor 2









AS-Interface expansion

There are different ways to extend the AS-i cable. The specified one hundred metres can be extended up to 1000 metres in extreme cases.

System overview	Page
AS-i repeaters	626
Scale drawings / drawing no. – CAD download: www.ifm.com	626 - 627

AS-i repeaters

Type	Description	Draw- ing no.	Order no.
	AS-i repeater · Extension of the AS-i network by another 100 m · One additional AS-i power supply necessary · Combicon connection · PA 6.6	–	AC2225
	Passive AS-i bus termination · Extension of the cable to a maximum of 200 m without additional repeater · Improvement of the signal quality · Monitoring of the supply voltage by means of LEDs	1	AC1147
	eASI-Tester · Local diagnosis of the AS-i network · Creation of test reports for AS-i networks · User-friendly diagnosis and evaluation via the connected PC	2	AC1145
	AS-i tuner diagnostic module · Extension of the cable to a maximum of 200 m without additional repeater · Monitoring of the message quality · Display of critical states by "traffic light" LEDs · PBT	3	AC1146

Scale drawings / drawing no. – CAD download: www.ifm.com

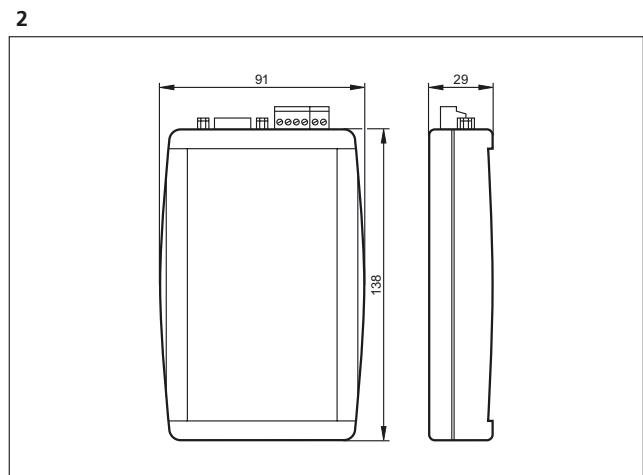
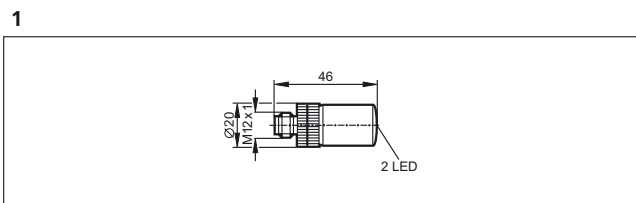

Scale drawings / drawing no. – CAD download: www.ifm.com

3

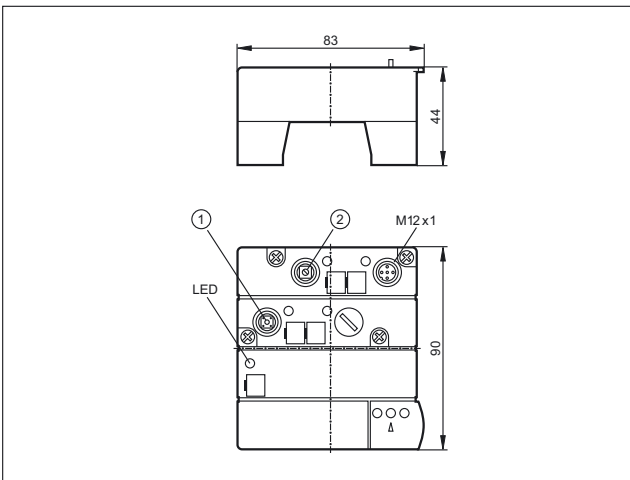

1: tune button, 2: mode selector



AS-Interface Safety at Work

The sophisticated AS-i technology and the extended diagnostic possibilities provide high reliability and machine uptime. "Safety at Work" is the extension of the AS-interface by safety-related components. Safety components up to the highest control category 4 to EN 954-1, SIL 3 to IEC 61508 and EN ISO 13849 - 1 / PL e can be connected to AS-i.

System overview	Page
Safety at Work	628 - 630
Accessories Safety at Work	630 - 631
AS-i manuals	631
Scale drawings / drawing no. – CAD download: www.ifm.com	631 - 634

Safety at Work





Type	Description	Draw- ing no.	Order no.
	AS-i safety monitor · Basic version · 1-channel · Configuration and setup by configuration software ASIMON · Screw terminal · polyamide black · Complies with the requirements: ISO 13849-1: PL e · IEC 61508: SIL 3	1	AC001S
	AS-i safety monitor · Basic version · 2-channel · Configuration and setup by configuration software ASIMON · Screw terminal · polyamide black · Complies with the requirements: ISO 13849-1: PL e · IEC 61508: SIL 3	1	AC002S
	AS-i safety monitor · Extended functionality · 1-channel · Configuration and setup by configuration software ASIMON · Screw terminal · polyamide black · Complies with the requirements: ISO 13849-1: PL e · IEC 61508: SIL 3	1	AC003S
	AS-i safety monitor · Extended functionality · 2-channel · Configuration and setup by configuration software ASIMON · Screw terminal · polyamide black · Complies with the requirements: ISO 13849-1: PL e · IEC 61508: SIL 3	1	AC004S
	AS-i safety monitor · Extended functionality and integrated safe slave for triggering a safe AS-i output · 2-channel · Configuration and setup by configuration software ASIMON V3.0 · Screw terminal · polyamide black · Complies with the requirements: ISO 13849-1: category 4 · ISO 13849-1: PL e · IEC 61508: SIL 3	2	AC032S
	AS-i safety monitor · 2 safe semi-conductor outputs · SIL 3 to EN 62061, IEC 61508 / SIL 3 and EN ISO 13849 - 1 / PL e · Chip card to save the configuration data · Configuration and setup by configuration software ASIMON V3 G2 · USB 2.0 interface · Chip card and Combicon screw terminals supplied with the device · Screw terminal	3	AC041S
	Safe active AS-i module · Performance Level e to EN ISO 13849-1 et IEC 61508 / SIL 3 for the connection of mechanical contacts · Combicon connection · PA · Complies with the requirements: ISO 13849-1: category 4 · ISO 13849-1: PL e · IEC 61508: SIL 3	4	AC009S
	Safe active AS-i output module · SIL 3 to EN 62061, IEC 61508 / SIL 3 and EN ISO 13849 - 1 / PL e · for the safe triggering of actuators · Combicon connection · PA · Complies with the requirements: ISO 13849-1: PL e · IEC 61508: SIL 3	5	AC030S
	Safe active AS-i module · Connection via M12x1 sockets or cage clamps · For connection of an electro-sensitive protective equipment (ESPE) type 4 to EN 61496-1 · PA 6 · Complies with the requirements: ISO 13849-1: category 4 · ISO 13849-1: PL e · IEC 61508: SIL 3	6	AC007S

Type	Description	Draw- ing no.	Order no.
	AS-i Safety at Work · Safe AS-i input module 2SI - 2LO · Addressing socket · Three orientations of the flat cable are possible · Sockets M12 x 1 · PA / Piercing contacts: CuSn6 surface nickel and tin-plated · Complies with the requirements: ISO 13849-1: category 4 · ISO 13849-1: PL e · IEC 62061: SILcl 3	7	AC505S
	AS-i Safety at Work · Safe AS-i input module 4SI / 2DO T / 2LO · Addressing socket · Three orientations of the flat cable are possible · Sockets M12 x 1 · PA / Piercing contacts: CuSn6 surface nickel and tin-plated · Complies with the requirements: ISO 13849-1: PL d · IEC 62061: SILcl 2	7	AC506S
	Safe active AS-i ClassicLine module · IR addressing possible · Performance Level e to EN ISO 13849-1 for the connection of mechanical contacts · Sockets M12 x 1 · PBT · Complies with the requirements: ISO 13849-1: category 4 · ISO 13849-1: PL e · IEC 61508: SIL 3	8	AC006S
	Illuminated E-STOP · front mounting · reset by turning · 2 NC contacts / 1 red LED · fool-proof E-STOP to EN ISO 13850	9	E7007S
	Illuminated E-STOP with integrated AS-i connection · fool-proof E-STOP to EN ISO 13850 · Pull to reset · AS-i interface via AS-i flat cable IP 67 · PC GF20 · Complies with the requirements: ISO 13849-1: category 4 · ISO 13849-1: PL e · IEC 61508: SIL 3	10	AC010S
	Key-release E-STOP with integrated AS-i connection · Connector M12 x 1 · AS-i interface via AS-i flat cable IP 67 · fool-proof E-STOP to EN ISO 13850 · Reset by key operation · PC GF20 · Complies with the requirements: ISO 13849-1: PL e · IEC 61508: SIL 3	11	AC011S
	safe AS-i e-stop operating unit with integrated AS-i connection · AS-i interface via M12 x 1 connector · fool-proof E-STOP to EN ISO 13850 · Pull to reset · interchangeable button inserts	12	AC012S
	Safe active AS-i ClassicLine module · AS-i version 2.1 · IR addressing possible · Control category 4 according to EN954-1 · For the connection of fail-safe inductive sensors of the control category 4 · Sockets M12 x 1 · PBT · Complies with the requirements: ISO 13849-1: category 4 · ISO 13849-1: PL e · IEC 61508: SIL 3	-	AC016S
	AS-i safety PCB · Connection of mechanical contact and LED components · Certification to ISO 13849-1: PL e and IEC 61508 / SIL 3 · Complies with the requirements: IEC 61508: SIL 3	13	AC015S
	Fail-safe inductive sensor · M12 connector, Gold-plated contacts · PPE / diecast zinc · Complies with the requirements: ISO 13849-1: category 4 · ISO 13849-1: PL e · IEC 61508: SIL 3	14	GM504S
	Fail-safe inductive sensor · M12 connector, Gold-plated contacts · PPE / diecast zinc · Complies with the requirements: ISO 13849-1: category 4 · ISO 13849-1: PL e · IEC 61508: SIL 3	14	GM505S
	Fail-safe inductive sensor · M18 x 1 · M12 connector, Gold-plated contacts · high-grade stainless steel / PBT · Complies with the requirements: ISO 13849-1: category 4 · ISO 13849-1: PL e · IEC 61508: SIL 3	15	GG505S
	Fail-safe inductive sensor · M30 x 1.5 · M12 connector, Gold-plated contacts · PEEK / high-grade stainless steel / O-ring: EPDM · Complies with the requirements: ISO 13849-1: category 4 · ISO 13849-1: PL e · IEC 61508: SIL 3	16	GI505S
	Safety switch with guard locking · Normally closed principle · Rotatable actuating head made of metal · Mechanical release on the front · Supply via AS-i / solenoid supply ext. from 24 V DC · M12 connector · thermoplastic reinforced glass-fibre	17	AC901S
	Safety switch with guard locking · Normally open principle · Rotatable actuating head made of metal · Mechanical release on the front · Supply via AS-i / solenoid supply ext. from 24 V DC · M12 connector · thermoplastic reinforced glass-fibre	17	AC902S
	Safety switch with guard locking · Normally closed principle · Rotatable actuating head made of metal · Mechanical release on the front · Supply via AS-i / solenoid supply from AS-i · M12 connector · thermoplastic reinforced glass-fibre	18	AC903S

Type	Description	Draw- ing no.	Order no.
	Safety switch with guard locking · Normally open principle · Rotatable actuating head made of metal · Mechanical release on the front · Supply via AS-i / solenoid supply from AS-i · M12 connector · thermoplastic reinforced glass-fibre	18	AC904S

Accessories Safety at Work

Type	Description	Order no.
	AS-i Safety at Work · Programming software for AS-i safety monitor AC001S / AC002S / AC003S / AC004S / AC032S · Version 3.0 · Configuration, set-up and diagnostics of the AS-i safety monitor	E7040S
	Software ASIMON V3 G2 · Configuration, set-up and diagnostics of the AS-i safety monitor · AC041S	E7050S
	USB interface cable for the connection of the safety monitor AC041S to the PC · cable length 1.8 m · 1.8 m	E7051S
	Chip card to save the configuration data of the AS-i safety monitor AC041S · 256 K	E7052S
	Safe contact expander without delay · 2 independent channels · 4 contact blocks (NO) per channel · 1 feedback circuit (NC) per channel · Mounting on DIN rail · Screw terminal	E7053S
	Connection cable PC / AS-i safety monitor · Parameter setting cable PC / AS-i safety monitor · Western connector RJ 45 8 poles / D-Sub socket 9 poles · 2.5 m	E7001S
	Connection cable AS-i safety monitor / AS-i safety monitor · Download cable AS-i safety monitor / AS-i safety monitor · Western connector RJ 45 8 poles · 0.3 m	E7002S
	EMERGENCY STOP label IP66 4 languages D,GB,F,I · EMERGENCY STOP label 4 languages for a safe illuminated EMERGENCY STOP button with integrated AS-i interface AC010S / AC011S / AC012S · 50 x 50 mm	E7003S
	EMERGENCY STOP protective collar · EMERGENCY STOP protective collar for safe E-STOP AC010S / AC011S / AC012S · Housing materials: PC GF20 RAL 1004	E7004S
	bridging plug for safety modules · Housing materials: PUR	E7005S
	Adapter plug · straight · M20 - M12 · M12 connector · 0.07 m · Housing materials: polyamide	E7006S
	Bolt for safety guards · for heavy doors · For right or left hinged doors without escape release · No additional door handle required · screw mounting onto common aluminium profiles and machine panels · Housing materials: diecast aluminium yellow	E7901S

Type	Description	Order no.
	Bolt for safety guards · for heavy doors · For right or left hinged doors without escape release · No additional door handle required · screw mounting onto common aluminium profiles and machine panels · Housing materials: glass-fibre reinforced plastic yellow	E7902S
	Actuator S standard straight · With rubber bush, overtravel 5 mm · Suitable for a maximum pull force of 2500 N for the door switches AC901S - AC904S	E7903S
	Actuator S standard angled · With rubber bush, overtravel 5 mm · Suitable for a maximum pull force of 2500 N for the door switches AC901S - AC904S	E7904S
	Hinged actuator left / right · For left or right hinged doors, overtravel 5 mm	E7905S
	Hinged actuator top / bottom · For top and bottom hinged doors, overtravel 5 mm	E7906S

AS-i manuals

Type	Description	Order no.
	ecolog asi system · AS-Interface Manual (German)	AC0115
	ecolog asi system · AS-Interface Manual (English)	AC0116
	AS-i Manual – Tips and tricks for users · German version	AC0350
	AS-i Manual – Tips and tricks for users · English version	AC0351
	AS-i Manual – Tips and tricks for users · French version	AC0352

Scale drawings / drawing no. – CAD download: www.ifm.com

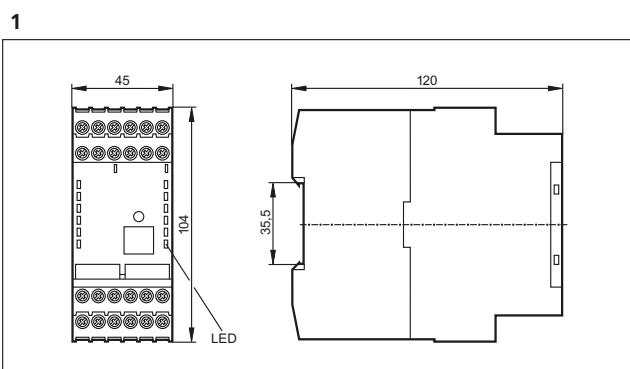

Scale drawings / drawing no. – CAD download: www.ifm.com

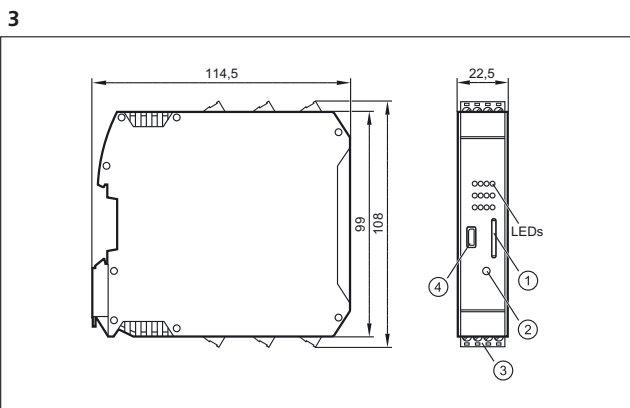
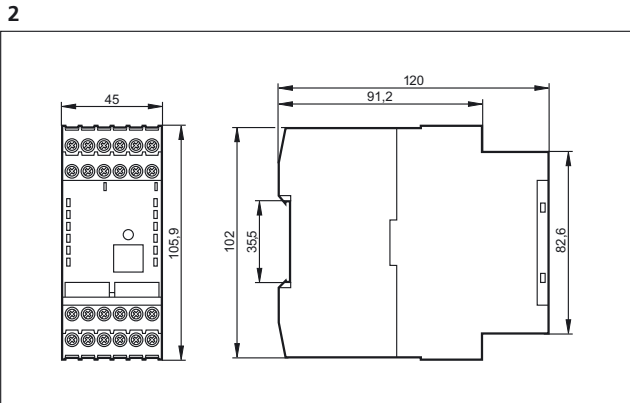

1: Chip card, 2: service button, 3: Combicon connector with screw terminals, 4: Micro USB interface

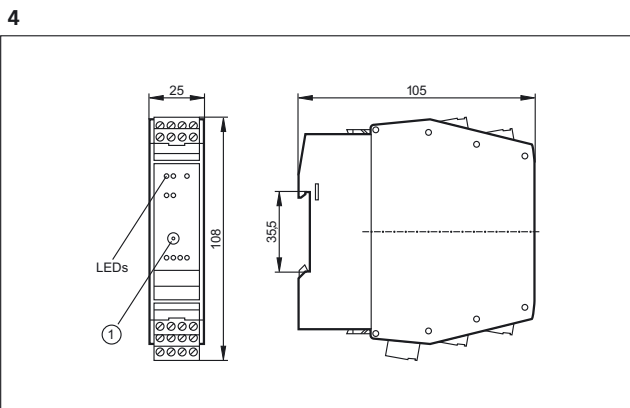

1: Addressing socket

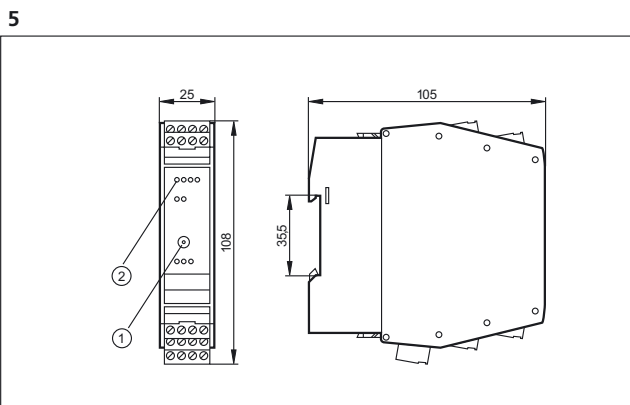

1: Addressing socket, 2: LED

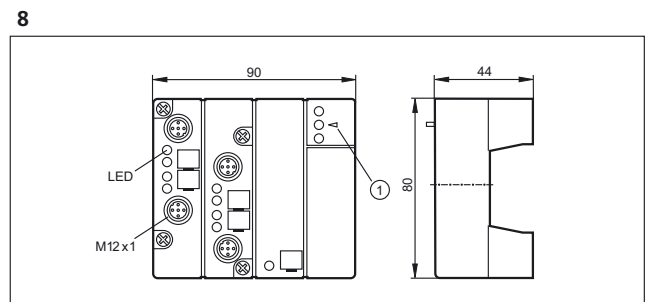
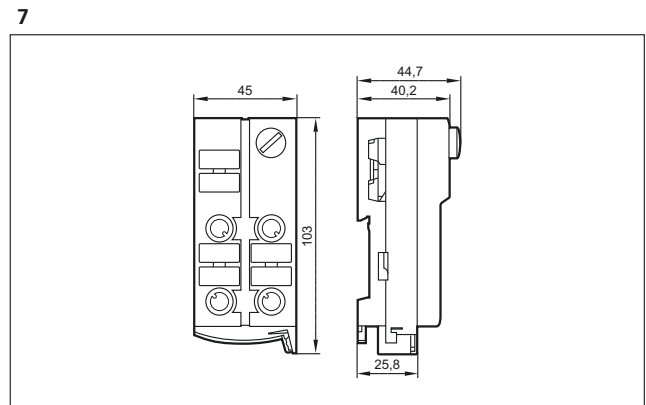
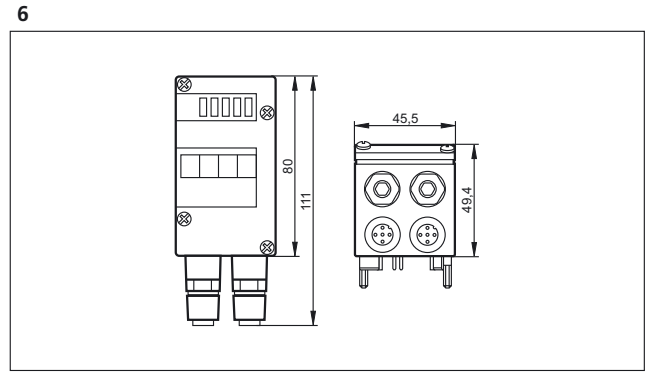

1: fixture infrared adapter

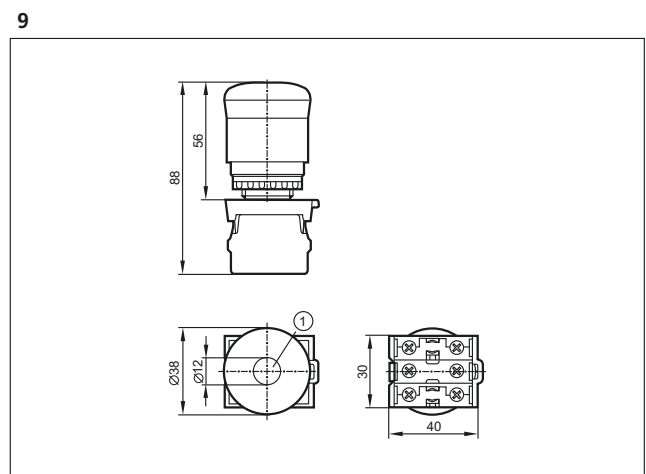

Scale drawings / drawing no. – CAD download: www.ifm.com

10

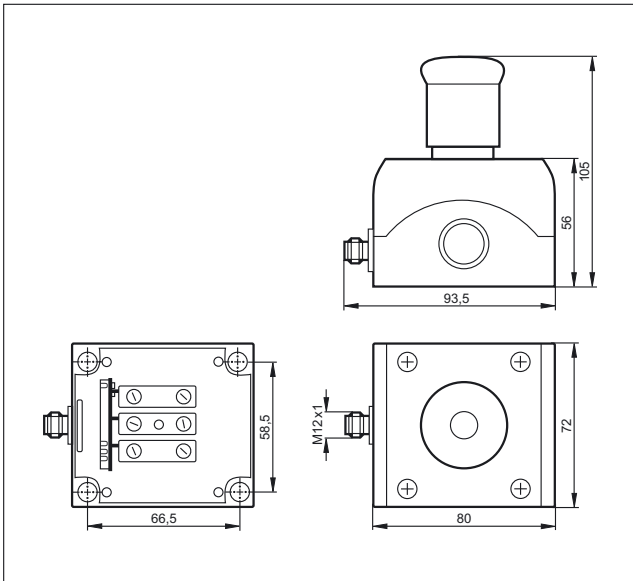

11

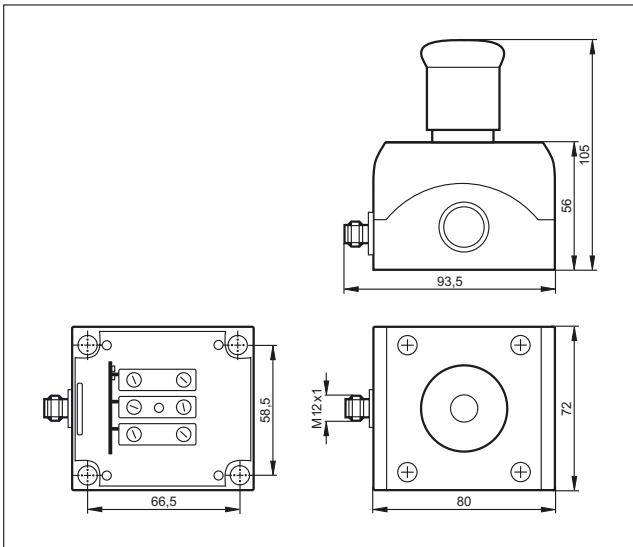

12

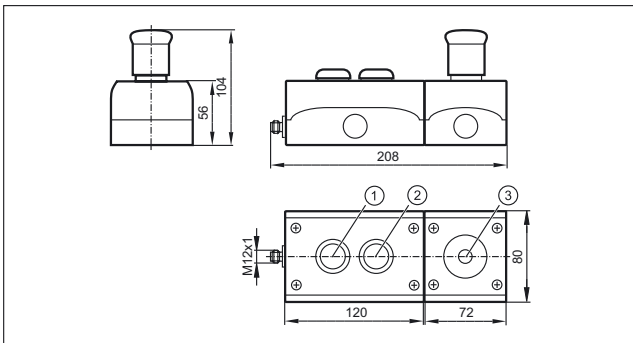

13

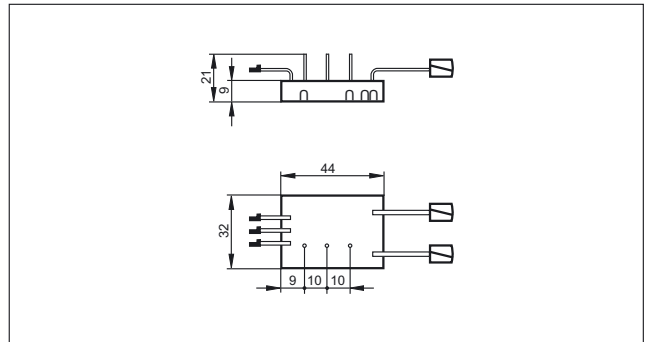

14

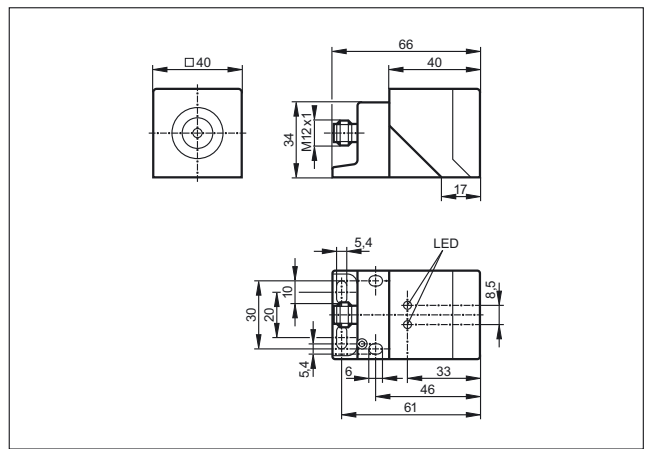

15

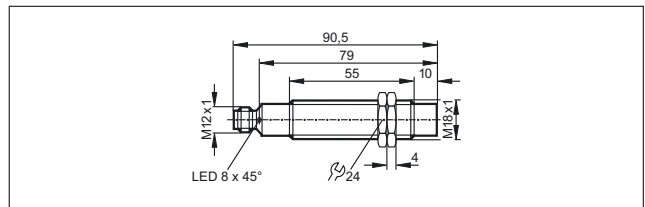

16

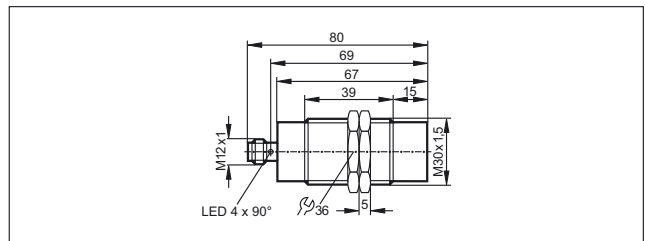

Scale drawings / drawing no. – CAD download: www.ifm.com

17

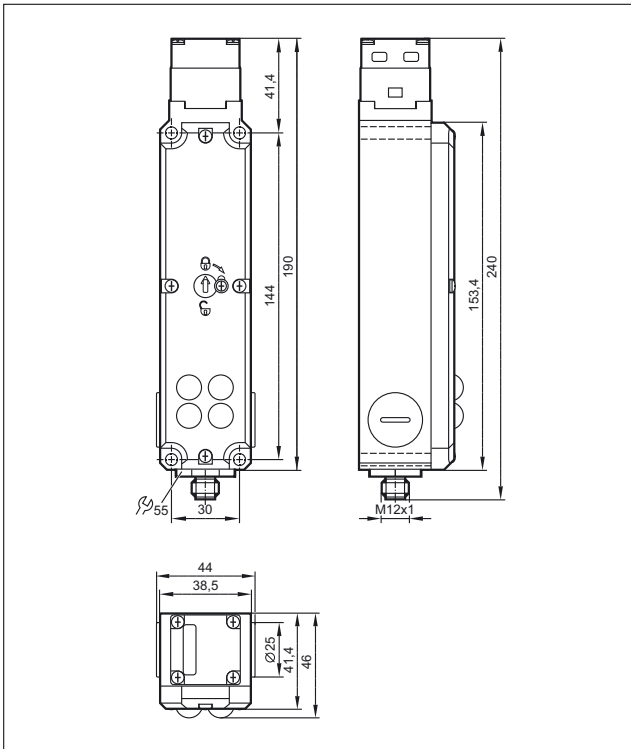

18

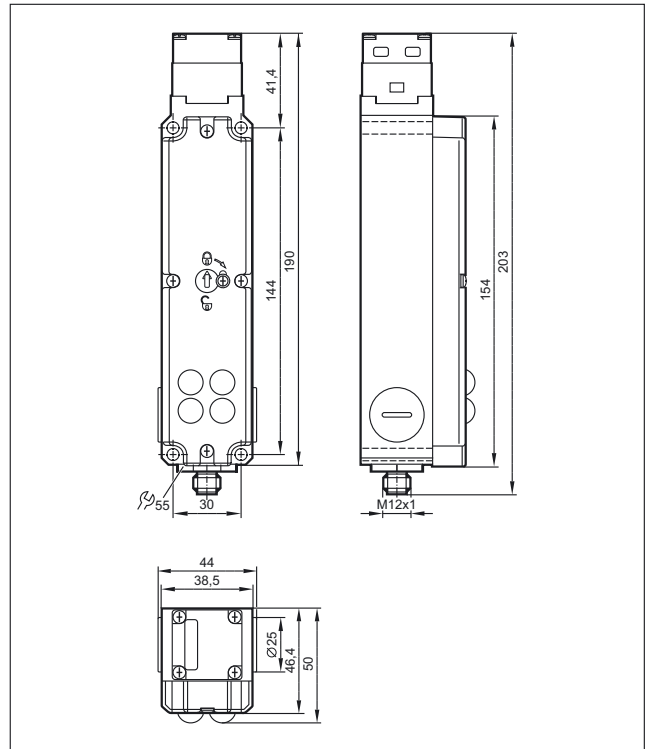



For more transparency in the system



Multicode reader type O2I – the compact all-rounder for optical identification tasks.



Multicode readers

ifm multicode readers handle not only the ECC200 Data Matrix code, but also many more 2D and 1D codes. Code reading is not dependent on the orientation of the code to the sensor. The industrially compatible mounting and wiring technology as well as the standardised process interfaces enable easy and quick integration into the industrial control system.

There is a wide range of applications for multicode readers in industry – from product tracking and production control to product identification. They are used for the automotive and food industries, conveying, the production of solar installations as well as machine tools and print machines.

RF identification systems

ifm offers different RFID systems using different frequencies, ranges, interfaces and data volumes.

LF 125 kHz system with AS-Interface

ifm supplies the first RFID system for AS-Interface worldwide. Up to 31 read / write heads can be connected to one AS-i master. Antenna, electronics and AS-Interface are integrated in a compact housing.

LF 125 kHz / HF 13.56 MHz system with different fieldbus interfaces

The RFID evaluation units DTE10x with integrated fieldbus interfaces and web server is widely used in production to mark tools, for quality assurance, to monitor production steps, in conveying and in automation technology.

The antenna concept guarantees easy and quick connection of the LF and HF RFID antennas to the evaluation unit by means of M12 connectors and standardised connection cables of up to 20 metres.





You will find an overview of all connection cables in the chapter "Connection technology".

RFID compact unit suitable for mobile use

The robust RFID compact unit with CANopen interface has been developed for identification tasks in agricultural machines, municipal vehicles and construction machines.

UHF system with Ethernet

As components of the UHF system platform, the read / write units DTE800 and DTE900 are compliant with the UHF bands in Europe and the USA respectively. The data transmission and parameter setting are carried out via Ethernet. The ultra low and low range antennas achieve selectivities of a few centimetres. The mid range antenna is chosen for applications in the near / far field with reading ranges of up to 2 m. The wide range antenna attains reading ranges of up to 10 m.

	<p>RFID 125 kHz</p>	<p>638 - 643</p>
	<p>RFID 13.56 MHz</p>	<p>644 - 649</p>
	<p>RFID UHF</p>	<p>650 - 653</p>
	<p>1D/2D code readers</p>	<p>654 - 660</p>





RFID 125 kHz



RFID systems based on 125 kHz for production and conveying technology, identification of workpiece carriers and products.

- System DTS 125 with AS-Interface
- System DTE 100 with Profibus DP
- System DTE 101 with Profinet
- System DTE 102 with Ethernet/IP

System overview	Page
RFID system 125 kHz with AS-Interface	638 - 639
ID tags 125 kHz for system DTS 125	639
Handheld readers for system DTS 125	640
Fixing components	640
DTE 101 RFID system with ProfiNet	640
DTE102 RFID system with EtherNet/IP	641
DTE 100 RFID system with Profibus DP	641
DTE104 RFID system with Ethernet TCP/IP	641
RFID antennas 125 kHz for system DTE100, DTE101, DTE102, DTE104	641
RFID tags 125 kHz for antenna ANT512	641
Accessories DTE100	642
Connection technology	642
Scale drawings / drawing no. – CAD download: www.ifm.com	642 - 643

RFID system 125 kHz with AS-Interface



Type	Dimensions [mm]	Travel speed read / write [m/s]	Process interface	Draw- ing no.	Order no.
M12 connector · Connector groups 8, 10, 18, 20, 120, 124, 126, 128, 157					
	55 x 24 x 41	read: ≤ 0.5 (distance to the ID tag 15 mm) write: only static	AS-i	1	DTA100
	55 x 24 x 41	read: ≤ 0.5 (distance to the ID tag 15 mm)	AS-i	1	DTA101
	40 x 40 x 54	read: ≤ 0.5 (distance to the ID tag 30 mm) write: only static	AS-i	2	DTA200

Type	Dimensions [mm]	Travel speed read / write [m/s]	Process interface	Draw- ing no.	Order no.
M12 connector · Connector groups 8, 10, 18, 20, 120, 124, 126, 128, 157					
	40 x 40 x 54	read: ≤ 0.5 (distance to the ID tag 30 mm)	AS-i	2	DTA201
	92 x 80 x 40	read: ≤ 0.5 (distance to the ID tag 40 mm) write: only static	AS-i	3	DTA300
	92 x 80 x 40	read: ≤ 0.5 (distance to the ID tag 40 mm)	AS-i	3	DTA301



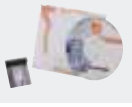

ID tags 125 kHz for system DTS 125

Type	Description	Order no.
	ID tag · ID-TAG/M5x16.5/01 · M5 x 16.5 mm · Screw mounting · Housing materials: PA black (RAL 9005)	E80301
	ID tag · ID-TAG/TRIANGLE HOUSING/01 · with ID tag E80301 · Housing materials: PBT orange (RAL 2003) / PA black (RAL 9005)	E80302
	ID tag · ID-TAG/M18x1/01 · M18 x 1 · Screw mounting · in metal · Housing materials: threaded sleeve: PBT orange	E80311
	ID tag · ID-TAG/D12x2/01 · Ø 12 x 2 mm · Housing materials: PPS black	E80312
	ID tag · ID-TAG/D20x2.15/01 · Ø 20 x 2.15 mm · Housing materials: polycarbonate black	E80317
	ID tag · ID-TAG/D30x2.15/01 · Ø 30 x 2.15 mm · Housing materials: polycarbonate black	E80318
	ID tag · ID-TAG/D50x2.2/01 · Ø 50 x 2.2 mm · Housing materials: polycarbonate black	E80319
	ID tag · ID-TAG/D26x4/01 · Ø 26 x 4 mm · Housing materials: PA High Temperature	E80322
	ID tag · ID-TAG/ISO-Card/01 · 54 x 86 x 1 mm · Housing materials: PVC white	E80320

Handheld readers for system DTS 125

Type	Description	Order no.
	RFID Handheld Reader USB · suitable for use in PCs or notebooks · 125 kHz · 1.8 m · Housing materials: PS	E80321
	RFID Handheld Reader CF Card · suitable for use in handheld PCs, pocket PCs or PDAs with CompactFlash interface · 125 kHz	E80323
	RFID Handheld Reader RS-232 · suitable for use in PCs or notebooks · 125 kHz · Housing materials: PS	E80324

Fixing components

Type	Description	Order no.
	Angle bracket · Housing materials: stainless steel	E80304
	Mounting set · Clamp mounting · aluminium profile · for type OC · Housing materials: fixture: stainless steel 316Ti / 1.4571 / clamp: diecast zinc / Cube: diecast zinc	E20901
	Mounting bracket · with integrated snap-on rail · for type IDC · Housing materials: stainless steel	E10730
	Mounting set · Clamp mounting · aluminium profile · for type OC · Housing materials: fixture: stainless steel 316Ti / 1.4571 / clamp: diecast zinc / Cube: diecast zinc	E20901
	Dovetail clamp · for type DTS, O4, O5 · Housing materials: AlMgSi0.5	E21088

DTE 101 RFID system with ProfiNet

Type	Description	Draw- ing no.	Order no.
Type DTE1 · M12 connector			
	RFID evaluation unit · for up to 4 read/write heads type ANT41x/ANT51x · Housing materials: Upper part: PA Grivory GV-5H orange / Upper part: TPE / lower part: GD-ALSi12	4	DTE101

DTE102 RFID system with EtherNet/IP

Type	Description	Draw- ing no.	Order no.
------	-------------	---------------------	--------------

Type DTE1 · M12 connector

	RFID evaluation unit · for up to 4 read/write heads type ANT41x/ANT51x · Housing materials: Upper part: PA Grivory GV-5H orange / Upper part: TPE / lower part: GD-ALSi12	4	DTE102
---	---	---	--------

DTE 100 RFID system with Profibus DP

Type	Description	Draw- ing no.	Order no.
------	-------------	---------------------	--------------

Type DTE1 · M12 connector

	RFID evaluation unit · for up to 4 read/write heads type ANT41x/ANT51x · Housing materials: Upper part: PA Grivory GV-5H orange / Upper part: TPE / lower part: GD-ALSi12	5	DTE100
---	---	---	--------

DTE104 RFID system with Ethernet TCP/IP

Type	Description	Draw- ing no.	Order no.
------	-------------	---------------------	--------------

Type DTE1 · M12 connector

	RFID evaluation unit · for up to 4 read/write heads type ANT41x/ANT51x · Housing materials: Upper part: PA Grivory GV-5H orange / Upper part: TPE / lower part: GD-ALSi12	4	DTE104
---	---	---	--------

RFID antennas 125 kHz for system DTE100, DTE101, DTE102, DTE104

Type	Description	Draw- ing no.	Order no.
------	-------------	---------------------	--------------





	Read/write head · M12 connector · 5 positions of the sensing face selectable · Housing materials: housing: PA / Metal parts: stainless steel	2	ANT512
---	--	---	--------

RFID tags 125 kHz for antenna ANT512





Type	Description	Order no.
------	-------------	--------------

	ID tag · ID-TAG/30X2.5/05 - 256 bit · Ø 30 x 2.5 mm · Housing materials: PA 6 black	E80360
	ID tag · ID-TAG/30X2.5/05 - 2048 bit · Ø 30 x 2.5 mm · Housing materials: PA 6 black	E80361

Accessories DTE100

Type	Description	Order no.
	Terminating resistor plug · straight · Free from silicone · Free from halogen · Gold-plated contacts · Housing materials: PUR	E12315
	Jumper · straight / straight · Free from halogen · Gold-plated contacts · 10 m · Housing materials: PUR	E12317
	Cable plug · straight · Free from halogen · Gold-plated contacts · M12 connector · 10 m · Housing materials: PUR	E12319
	Socket · straight · Free from halogen · Gold-plated contacts · M12 connector · 10 m · Housing materials: PUR	E12321

Connection technology

Type	Description	Order no.
	Jumper · straight / straight · Ethernet · Cross-over patch cable · 2 m · Housing materials: PUR / PC	E11898
	Jumper · straight / straight · Ethernet · Patch cable · 2 m · Housing materials: PUR / PC	E12090
	Jumper · straight / straight · Ethernet · Cross-over patch cable · 10 m · Housing materials: PUR / PC	E12204
	Jumper · straight / straight · Ethernet · Cross-over patch cable · 20 m · Housing materials: PUR / PC	E12205

Scale drawings / drawing no. – CAD download: www.ifm.com

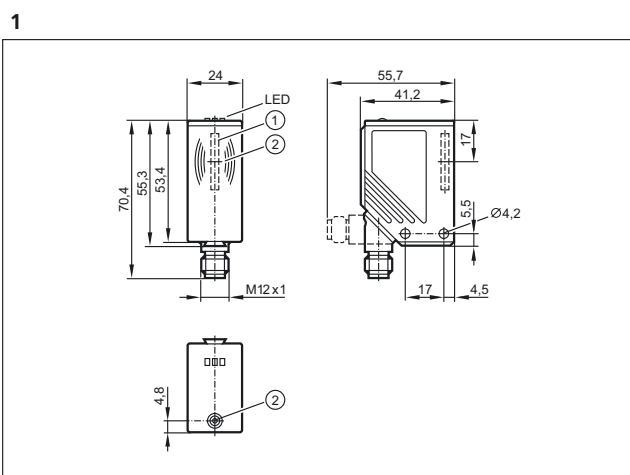

1: integrated antenna, 2: tag positioning mark (middle of the antenna)

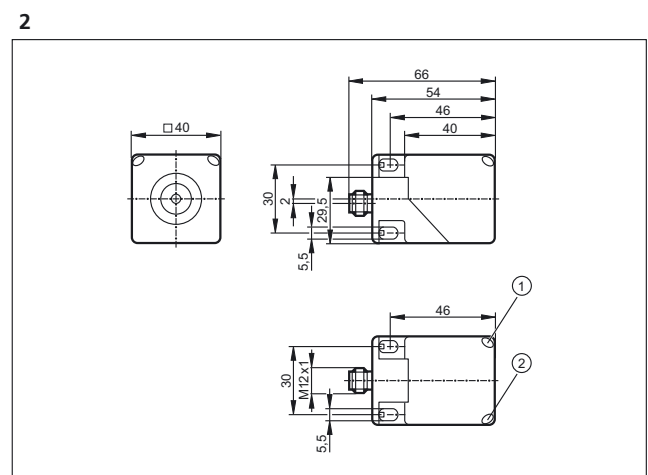

1: LED yellow, 2: LED green

Scale drawings / drawing no. – CAD download: www.ifm.com

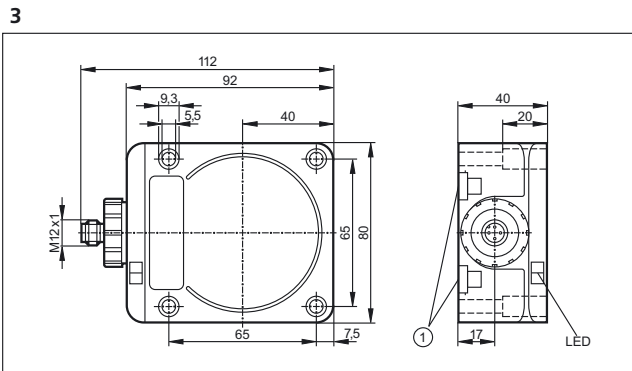

1: Mounting on DIN rail

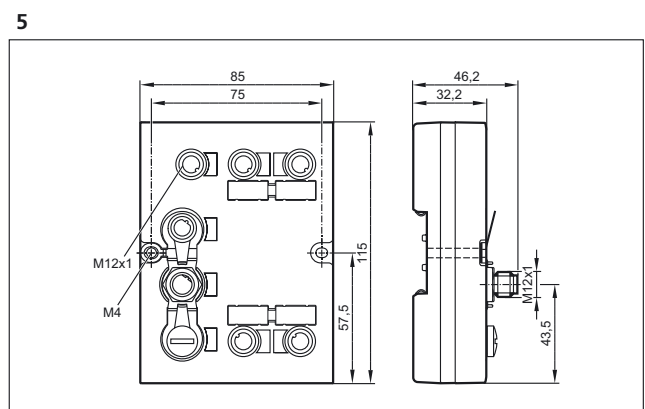
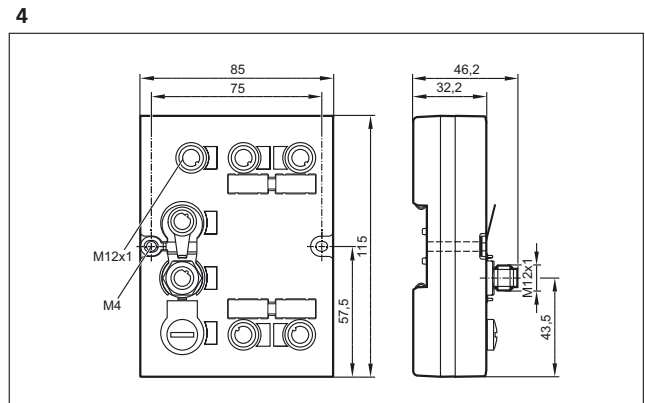



RFID 13.56 MHz

Flexible system for production, assembly and handling technology. Ensures fast data transmission and supports the ISO 15693 standard.

- DTE100 system with Profibus DP
- DTE101 system with Profinet
- DTE102 system with EtherNet/IP
- DTE104 system with EtherNetTCP/IP

System overview	Page
DTE 100 RFID system with Profibus DP	644
DTE 101 RFID system with ProfiNet	644
DTE102 RFID system with EtherNet/IP	645
DTE104 RFID system with Ethernet TCP/IP	645
RFID antennas 13.56 MHz for system DTE100, DTE101, DTE102, DTE104	645
RFID systems DTM424, DTM425, DTM434, DTM435 for mobile machines	646
RFID tags 13.56 MHz for antennas ANT513, ANT410, ANT411, ANT430, ANT431, DTM424, DTM425, DTM434, DTM435	646
Accessories DTE100	647
Accessories DTM	647
Connection technology	647 - 648
Scale drawings / drawing no. – CAD download: www.ifm.com	648 - 649

DTE 100 RFID system with Profibus DP

Type	Description	Draw- ing no.	Order no.
------	-------------	---------------------	--------------

Type DTE1 · M12 connector

	RFID evaluation unit · for up to 4 read/write heads type ANT41x/ANT51x · Housing materials: Upper part: PA Grivory GV-5H orange / Upper part: TPE / lower part: GD-ALSi12	1	DTE100
---	---	---	--------

DTE 101 RFID system with ProfiNet

Type	Description	Draw- ing no.	Order no.
------	-------------	---------------------	--------------

Type DTE1 · M12 connector

	RFID evaluation unit · for up to 4 read/write heads type ANT41x/ANT51x · Housing materials: Upper part: PA Grivory GV-5H orange / Upper part: TPE / lower part: GD-ALSi12	2	DTE101
---	---	---	--------

DTE102 RFID system with EtherNet/IP

Type	Description	Draw- ing no.	Order no.
------	-------------	---------------------	--------------

Type DTE1 · M12 connector

	RFID evaluation unit · for up to 4 read/write heads type ANT41x/ANT51x · Housing materials: Upper part: PA Grivory GV-5H orange / Upper part: TPE / lower part: GD-ALSi12	2	DTE102
---	---	---	--------

DTE104 RFID system with Ethernet TCP/IP





Type	Description	Draw- ing no.	Order no.
------	-------------	---------------------	--------------

Type DTE1 · M12 connector





	RFID evaluation unit · for up to 4 read/write heads type ANT41x/ANT51x · Housing materials: Upper part: PA Grivory GV-5H orange / Upper part: TPE / lower part: GD-ALSi12	2	DTE104
---	---	---	--------

RFID antennas 13.56 MHz for system DTE100, DTE101, DTE102, DTE104

Type	Description	Draw- ing no.	Order no.
------	-------------	---------------------	--------------

	Read/write head · M12 connector · Housing materials: housing: stainless steel / Top: PPS	3	ANT410
	Read/write head · M12 connector · Housing materials: housing: stainless steel / Top: PPS	4	ANT411
	Read/write head · M12 connector · Housing materials: housing: stainless steel / Top: PPS	5	ANT430
	Read/write head · M12 connector · Housing materials: housing: stainless steel / Top: PPS	6	ANT431
	Read/write head · M12 connector · 5 positions of the sensing face selectable · Housing materials: housing: PA / Metal parts: stainless steel	7	ANT513

RFID systems DTM424, DTM425, DTM434, DTM435 for mobile machines

Type	Description	Draw- ing no.	Order no.
Type M18 x 1.5 · M12 connector · CANopen interface			
	Read/write head · M18 x 1.5 · M12 connector · Housing materials: housing: stainless steel / Top: PPS / connector housing: PEI	8	DTM424
	Read/write head · M18 x 1.5 · M12 connector · Housing materials: housing: stainless steel / Top: PPS / connector housing: PEI	9	DTM425
Type M30 x 1.5 · M12 connector · CANopen interface			
	Read/write head · M30 x 1.5 · M12 connector · Housing materials: housing: stainless steel / Top: PPS / connector housing: PEI	10	DTM434
	Read/write head · M30 x 1.5 · M12 connector · Housing materials: housing: stainless steel / Top: PPS / connector housing: PEI	11	DTM435







**RFID tags 13.56 MHz for antennas
ANT513, ANT410, ANT411, ANT430, ANT431, DTM424, DTM425, DTM434, DTM435**

Type	Description	Order no.
	ID tag · ID-TAG/30X2.8/03 - 64 Kbit · Ø 30 x 2.8 mm · Housing materials: PA 6	E80380
	ID tag · ID-TAG/30X2.8/03 - 16 Kbit · Ø 30 x 2.8 mm · Housing materials: PA 6 black	E80370
	ID tag · ID-TAG/30X2.5/06 - 896 bit · Ø 30 x 2.5 mm · Housing materials: PA 6 black	E80371
	ID tag · ID-TAG/R20X2.5/06 - 896 Bit · Ø 20 x 2.5 mm · Housing materials: PPA	E80377
	ID tag · ID-TAG/4.35X3.6/03 - 896 bit · Ø 4.3 x 3.6 mm	E80381
	ID tag · ID-TAG/Label 65X30/03 - 896 bit	E80382
	ID tag · ID-TAG/Label 80x50/03 - 896 bit	E80379

Accessories DTE100

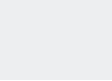
Type	Description	Order no.
	Terminating resistor plug · straight · Free from silicone · Free from halogen · Gold-plated contacts · Housing materials: PUR	E12315
	Jumper · straight / straight · Free from halogen · Gold-plated contacts · 10 m · Housing materials: PUR	E12317
	Cable plug · straight · Free from halogen · Gold-plated contacts · M12 connector · 10 m · Housing materials: PUR	E12319
	Socket · straight · Free from halogen · Gold-plated contacts · M12 connector · 10 m · Housing materials: PUR	E12321

Accessories DTM

Type	Description	Order no.
	BasicDisplay XL · 4.3" colour display · 6 freely programmable backlit function keys · Navigation key for cursor function · CAN interface · Programming according to IEC 61131-3 · 8...32 V DC	CR0452
	Socket · straight · Free from silicone · Free from halogen · Gold-plated contacts · For applications in particularly harsh environments · M12 connector · 2 m · Housing materials: housing: TPU orange / sealing: FKM	EVM036
	Socket · straight · Free from silicone · Free from halogen · Gold-plated contacts · For applications in particularly harsh environments · M12 connector · 10 m · Housing materials: housing: TPU orange / sealing: FKM	EVM038
	Socket · angled · Free from silicone · Free from halogen · Gold-plated contacts · M12 connector with integrated CAN terminating resistor (120 ohm) · 5 m · Housing materials: housing: TPU black / sealing: FKM	EVC492
	Jumper · angled / angled · Free from silicone · Free from halogen · Gold-plated contacts · 5 m · Housing materials: housing connector: TPU orange / housing socket: TPU black transparent / sealing: FKM	EVC039
	Jumper · angled / straight · Free from silicone · Free from halogen · Gold-plated contacts · 5 m · Housing materials: housing: TPU orange / sealing: FKM	EVC069

Connection technology

Type	Description	Order no.
	Jumper · straight / straight · Ethernet · Cross-over patch cable · 2 m · Housing materials: PUR / PC	E11898

Type	Description	Order no.
	Jumper · straight / straight · Ethernet · Patch cable · 2 m · Housing materials: PUR / PC	E12090
	Jumper · straight / straight · Ethernet · Cross-over patch cable · 10 m · Housing materials: PUR / PC	E12204
	Jumper · straight / straight · Ethernet · Cross-over patch cable · 20 m · Housing materials: PUR / PC	E12205

Scale drawings / drawing no. – CAD download: www.ifm.com

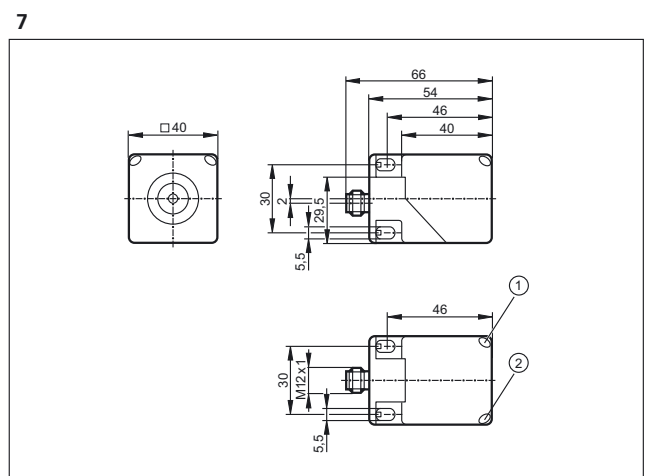
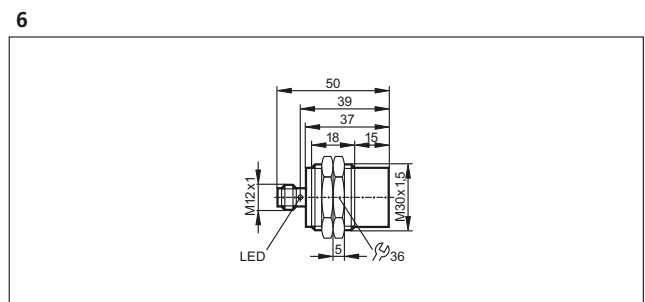
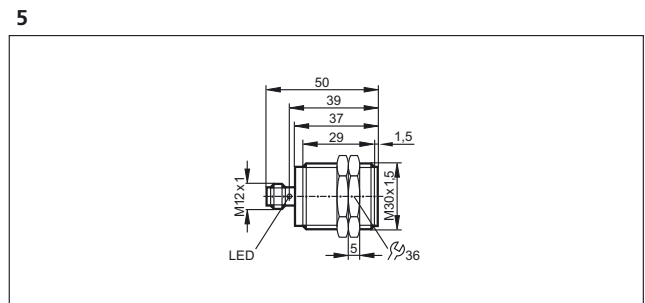
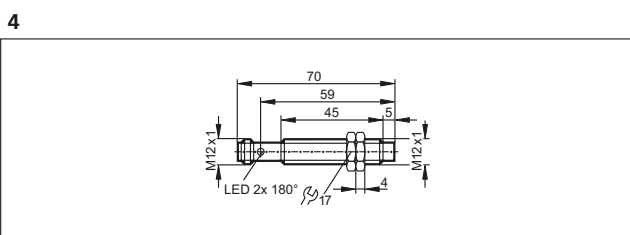
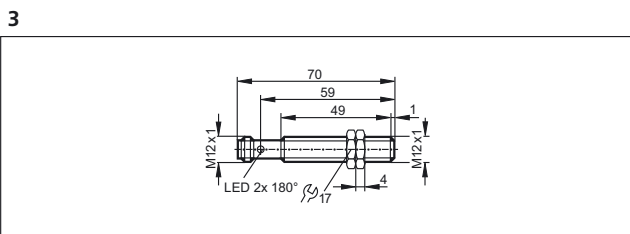
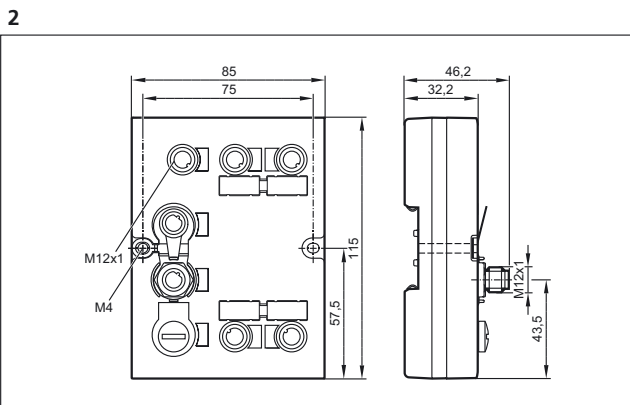
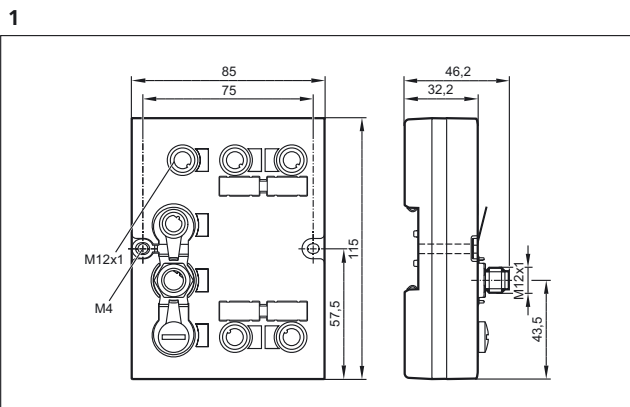

1: LED yellow, 2: LED green

Scale drawings / drawing no. – CAD download: www.ifm.com

8

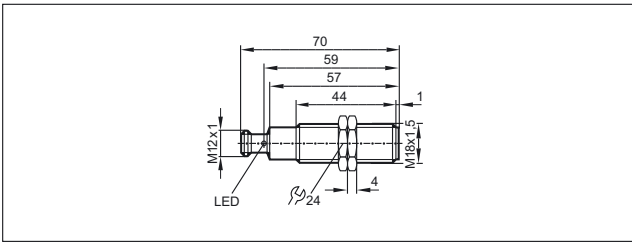

9

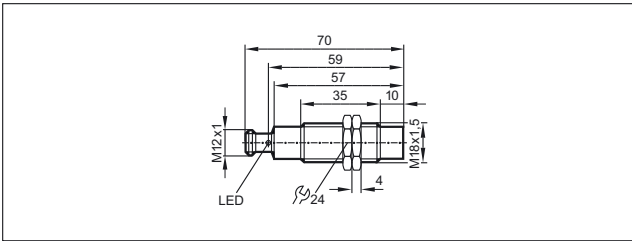

10

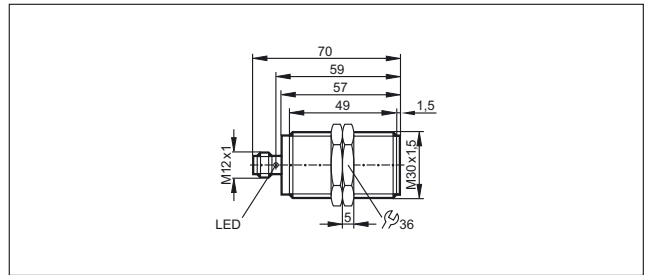

11

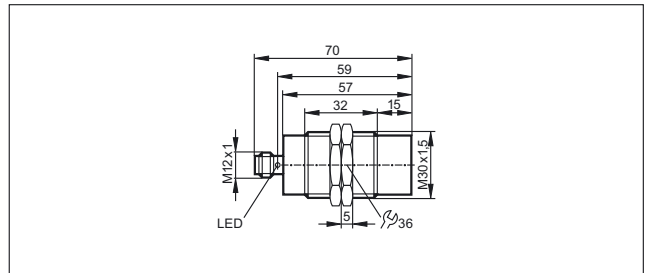



RFID UHF

The system is optimised for applications in production control, asset management, material flow control, track & trace and supply chain management:





- System DTE 800 for EU/ETSI
- System DTE 810 with Ethernet/IP
- System DTE 900 for US/FCC
- System DTE 910 with Ethernet/IP

System overview	Page
RFID UHF readers	650
RFID UHF antennas	651
ID tags UHF	651
Accessories for UHF systems	652
Scale drawings / drawing no. – CAD download: www.ifm.com	652 - 653





RFID UHF readers

Type	Dimensions [mm]	Operating frequency [MHz]	Transmission power [mW ERP]	Number of antenna inputs	Process interface	Output	Drawing no.	Order no.
M12 connector · Connector groups 8, 10, 18, 20, 120, 124, 126, 128, 157								
	233.5 x 270 x 68	865-868 (ETSI)	2000	4	Ethernet TCP/IP	–	1	DTE800
	233.5 x 270 x 68	902...928 (FCC)	2000	4	Ethernet TCP/IP	–	1	DTE900
	233.5 x 270 x 68	865-868 (ETSI)	2000	4	EtherNet/IP	–	1	DTE810
	233.5 x 270 x 68	902...928 (FCC)	2000	4	EtherNet/IP	–	1	DTE910
M12 connector · Connector group --								
	–	865-868 (ETSI)	266	–	Ethernet TCP/IP	–	2	DTE820



RFID UHF antennas

Type	Dimensions [mm]	Operating frequency [MHz]	Antenna gain [cBic]	Max. input power [mW]	Protection	Draw- ing no.	Order no.
TNC socket							
	63 x 28 x 90	865...928	-30	1000	IP 67	3	ANT805
	63 x 28 x 90	865...870	-15	500	IP 67	3	ANT810
	126 x 37 x 156	865...928	-12 (866 MHz) / -10 (915 MHz)	-	IP 67	4	ANT815
	126 x 37 x 156	865...870	2.5	-	IP 67	4	ANT820
	271 x 270 x 42	865...870	8.5	-	IP 65	5	ANT830
	63 x 28 x 90	902...928 (FCC)	-15	500	IP 67	3	ANT910
	271 x 270 x 42	902...928 (FCC)	8.3	-	IP 65	5	ANT930

ID tags UHF

Type	Description	Order no.
	ID tag · ID-TAG/D50x3.3/04 · Ø 50 x 3.3 mm · Housing materials: PA 6	E80350
	ID tag · ID-TAG/D55x13/04 · Ø 55 x 13 mm · Housing materials: PA 6	E80351
	ID tag · ID-TAG/R30X10/04 · Ø 30 x 10 mm · Housing materials: PU black	E80353
	ID tag · ID-TAG/R40X10/04 · 40 x 32 x 8 mm · Housing materials: nylon black	E80354

Accessories for UHF systems

Type	Description	Order no.
	Jumper · straight / straight · For RFID antenna · 3 m	E80330
	Jumper · straight / straight · For RFID antenna · 6 m	E80331
	Jumper · straight / straight · For RFID antenna · 10 m	E80332
	Jumper · straight / straight · For RFID antenna · 15 m	E80333
	Jumper · straight / straight · Ethernet · Cross-over patch cable · 2 m · Housing materials: PUR / PC	E11898
	Jumper · straight / straight · Ethernet · Cross-over patch cable · 10 m · Housing materials: PUR / PC	E12204
	Clamp · for RFID UHF readers DTE800/DTE900 and antennas ANT830/ANT930 · Housing materials: fixture: steel sheet galvanised / screws: stainless steel / Fixing strap: stainless steel	E80340

Scale drawings / drawing no. – CAD download: www.ifm.com

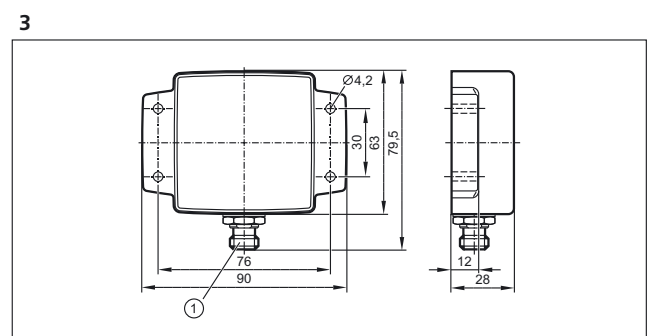
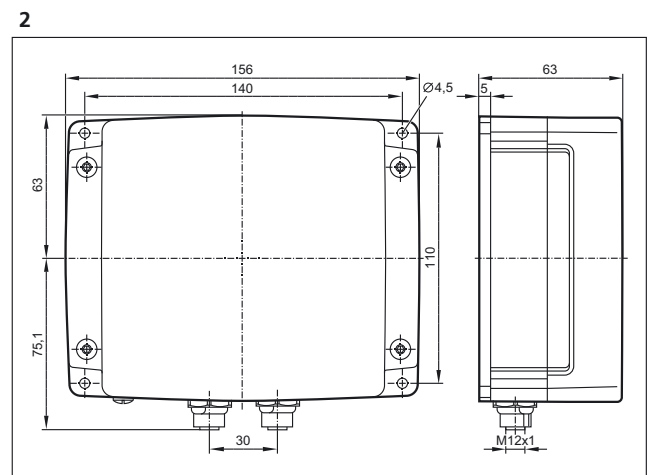
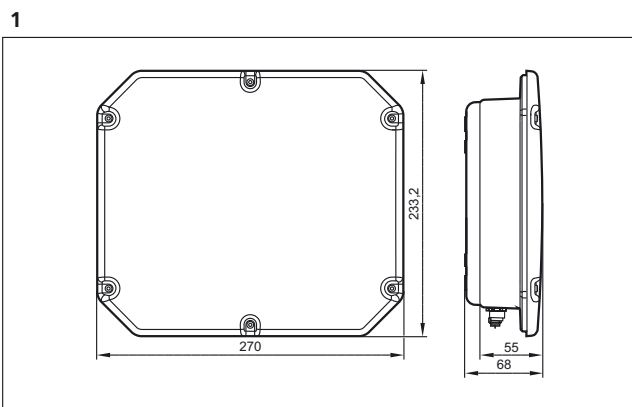

1: TNC socket

Scale drawings / drawing no. – CAD download: www.ifm.com

4

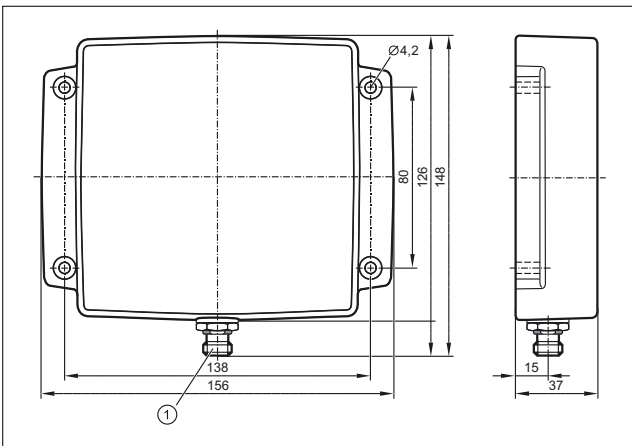

1: TNC socket

5

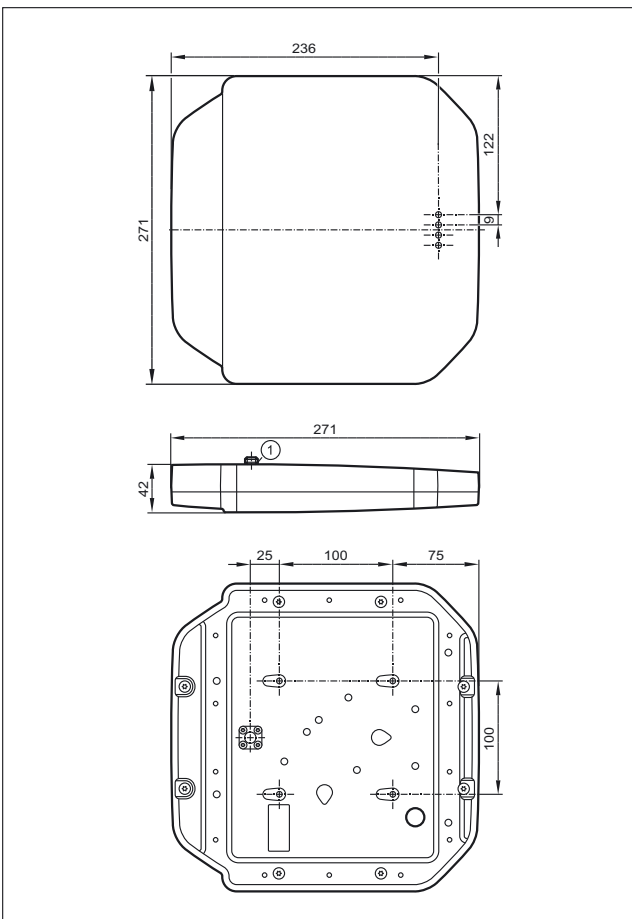

1: TNC socket







1D/2D code readers

Photoelectric multicode reader for 1D bar codes and 2D codes. Versions with infrared light and red light as well as different field of view sizes are available.





System overview	Page
Multicode reader	654 - 655
Multicode reader with text recognition	655
Illumination units	656
Software	656
Panel PC for Multicode Reader	657
Fixing components	657 - 658
Protective panes and diffusers	658
Connection technology	658
Wiring diagrams	659
Scale drawings / drawing no. – CAD download: www.ifm.com	659 - 660

Multicode reader

Type	Dimensions [mm]	Max. field of view size [mm]	Type of light LED	Motion speed int. / ext. lighting [m/s]	Process interface	Drawing no.	Order no.
Multicode Reader · M12 plug, 8 poles · M12 socket, 4 poles · Connector groups 16, 17							
	60 x 42 x 53.5	64 x 48	red light	3 / 5	Ethernet TCP/IP, EtherNet/IP, RS-232	1	O2I100
	60 x 42 x 53.5	132 x 94	red light	3 / 5	Ethernet TCP/IP, EtherNet/IP, RS-232	1	O2I102
	60 x 42 x 59	400 x 300	red light	3 / 5	Ethernet TCP/IP, EtherNet/IP, RS-232	2	O2I104
	60 x 42 x 53.5	64 x 48	infrared	3 / 5	Ethernet TCP/IP, EtherNet/IP, RS-232	1	O2I101
	60 x 42 x 53.5	132 x 94	infrared	3 / 5	Ethernet TCP/IP, EtherNet/IP, RS-232	1	O2I103

Type	Dimensions [mm]	Max. field of view size [mm]	Type of light LED	Motion speed int. / ext. lighting [m/s]	Process interface	Draw- ing no.	Order no.
Multicode Reader · M12 plug, 8 poles · M12 socket, 4 poles · Connector groups 16, 17							
	60 x 42 x 59	400 x 300	infrared	3 / 5	Ethernet TCP/IP, EtherNet/IP, RS-232	2	O2I105
	60 x 42 x 53.5	64 x 48	red light	3 / 5	Ethernet TCP/IP, EtherNet/IP, RS-232	1	O2I300
	60 x 42 x 53.5	132 x 94	red light	3 / 5	Ethernet TCP/IP, EtherNet/IP, RS-232	1	O2I302
	60 x 42 x 59	400 x 300	red light	3 / 5	Ethernet TCP/IP, EtherNet/IP, RS-232	2	O2I304
	60 x 42 x 53.5	64 x 48	infrared	3 / 5	Ethernet TCP/IP, EtherNet/IP, RS-232	1	O2I301
	60 x 42 x 53.5	132 x 94	infrared	3 / 5	Ethernet TCP/IP, EtherNet/IP, RS-232	1	O2I303
	60 x 42 x 59	400 x 300	infrared	3 / 5	Ethernet TCP/IP, EtherNet/IP, RS-232	2	O2I305



Multicode reader with text recognition

Type	Dimensions [mm]	Max. field of view size [mm]	Type of light LED	Motion speed int. / ext. lighting [m/s]	Process interface	Draw- ing no.	Order no.
Multicode Reader · M12 plug, 8 poles · M12 socket, 4 poles · Connector groups 16, 17							
	60 x 42 x 53.5	–	red light	3 / 5	Ethernet	1	O2I350
	60 x 42 x 53.5	–	red light	3 / 5	Ethernet	1	O2I352
	60 x 42 x 59	–	red light	3 / 5	Ethernet	2	O2I354
	60 x 42 x 53.5	–	infrared	3 / 5	Ethernet	1	O2I351
	60 x 42 x 53.5	–	infrared	3 / 5	Ethernet	1	O2I353
	60 x 42 x 59	–	infrared	3 / 5	Ethernet	2	O2I355



Illumination units

Type	Dimensions [mm]	Type of light	Active illuminated area [mm]	I ₀ normal light intensity [mA]	I ₀ high light intensity [mA]	Trigger	Draw- ing no.	Order no.
------	--------------------	------------------	---------------------------------------	---	---	---------	---------------------	--------------

M12 connector · metal · DC · Wiring diagram no. 1 · Connector groups 8, 10, 18, 20, 120, 124, 126, 128, 157

	42 x 42 x 31	Red	–	180	90	External; 24 V PNP to IEC61131-1	3	O2D909
	42 x 42 x 32.2	Red	–	180	90	External; 24 V PNP to IEC61131-1	4	O2D913

PUR cable with M12 connector 0.3 m · metal · DC · Wiring diagram no. 1 · Connector groups 8, 10, 18, 20, 120, 124, 126, 128, 157

	Ø 122 / L = 20.5	Infrared	–	800	1400	external; 24 V PNP	5	O2D917
	116 x 13 x 18	Infrared	–	185	325	external; 24 V PNP	6	O2D922
	200 x 13 x 18	Infrared	–	415	640	external; 24 V PNP	7	O2D925











Software

Type	Description	Number of connections	Order no.
	Operating software · O2I · for multicode reader · Create and manage application-specific configurations Monitor mode for set-up and service · Service reports for statistical evaluations	–	E2I200
	Multicode reader OPC server · Software · German/English	25	E2I210
	Multicode reader OPC server · Software · German/English	50	E2I211
	Multicode reader OPC server · Software · German/English	75	E2I212
	Multicode reader OPC server · Software · German/English	100	E2I213

Panel PC for Multicode Reader

Type	Description	Order no.
	Touch Panel PC · 12.1" colour display · Intel Atom CPU 1.6 GHz · 2 GByte RAM · Windows Embedded Standard 7 SP1 (32 bits)	E2D400



Fixing components

Type	Description	Order no.
	Mounting set · O2D, O2M, O2I, O2V · Clamp mounting · rod mounting Ø 12 mm · Housing materials: fixture: stainless steel / clamp: stainless steel	E2D110
	Mounting set · O2D, O2M, O2I, O2V · Clamp mounting · rod mounting Ø 14 mm · Housing materials: fixture: stainless steel / clamp: stainless steel	E2D112
	Mounting set · Bar light · Clamp mounting · Housing materials: Mounting bracket: stainless steel / clamp: high-grade stainless steel	E2D114
	Mounting set · Bar light · Clamp mounting · for 4 bar lights 10x75 mm · Housing materials: Mounting bracket: stainless steel / clamp: high-grade stainless steel	E2D116
	Mounting set · Ring light · Clamp mounting · Housing materials: Mounting bracket: stainless steel / clamp: high-grade stainless steel	E2D201
	clamp · Ø 12 mm; M10 · Free-standing M10 · Housing materials: clamp: stainless steel	E20946
	clamp · Ø 12 mm · rod mounting Ø 12 mm · Housing materials: clamp: stainless steel	E21110
	clamp · Ø 14 mm; M12 · free-standing M12 · Housing materials: clamp: stainless steel	E20948
	clamp · Ø 14 mm · rod mounting Ø 14 mm · Housing materials: clamp: stainless steel	E21109
	mounting rod · Ø 12 · Length: 200 mm · straight · Housing materials: stainless steel 316Ti / 1.4571	E21112
	mounting rod · Ø 12 · Length: 300 mm · straight · Housing materials: stainless steel 316Ti / 1.4571	E21113
	mounting rod · Ø 12 / M10 · Length: 130 mm · straight · Housing materials: stainless steel 316Ti / 1.4571	E20938

Identification systems

Type	Description	Order no.
	mounting rod · Ø 12 / M10 · Length: 200 mm · angled · Housing materials: stainless steel 316Ti / 1.4571	E20940
	mounting rod · Ø 14 / M12 · Length: 130 mm · straight · Housing materials: stainless steel 316Ti / 1.4571	E20939
	mounting rod · Ø 14 / M12 · Length: 200 mm · angled · Housing materials: stainless steel 316Ti / 1.4571	E20941
	Connection piece · Ø 20 mm · for the connection of two clamps with Ø 20 mm · Housing materials: stainless steel 316L / 1.4404	E21076

Protective panes and diffusers

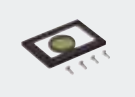
Type	Description	Order no.
	Plastic diffuser · O2D / O2I · Housing materials: housing: diecast zinc black / lens: PMMA	E21165
	Plastic protective pane for the food industry · O2D / O2I · Housing materials: housing: diecast zinc black / lens: PMMA	E21166
	Glass protective pane · O2D / O2I · Housing materials: housing: diecast zinc black / lens: float glass	E21168
	Laser protection pane plastic · O2D / O2I · Housing materials: housing: diecast zinc black / lens: PMMA / filter: polycarbonate	E21169

Connection technology

Type	Description	Order no.
	Jumper · straight / straight · Ethernet · Cross-over patch cable · 2 m · Housing materials: PUR / PC	E11898
	Jumper · straight / straight · Ethernet · Patch cable · 2 m · Housing materials: PUR / PC	E12090
	Jumper · straight / straight · Ethernet · Cross-over patch cable · 10 m · Housing materials: PUR / PC	E12204
	Jumper · straight / straight · Ethernet · Cross-over patch cable · 20 m · Housing materials: PUR / PC	E12205

Wiring diagrams

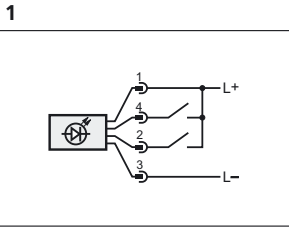

1: Trigger, 2: Operating mode "high light intensity"

Scale drawings / drawing no. – CAD download: www.ifm.com

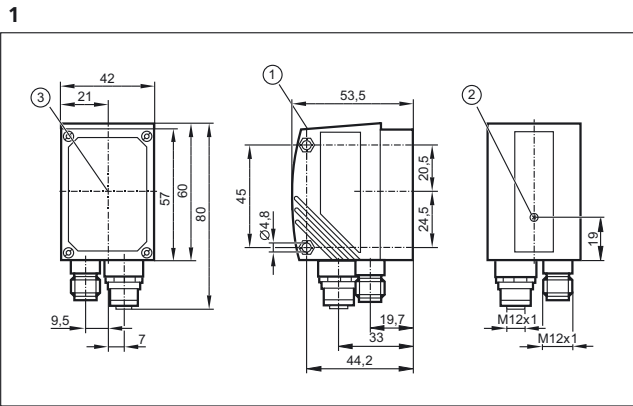

1: display, 2: Focus adjustment screw, 3: Centre of the lens axes

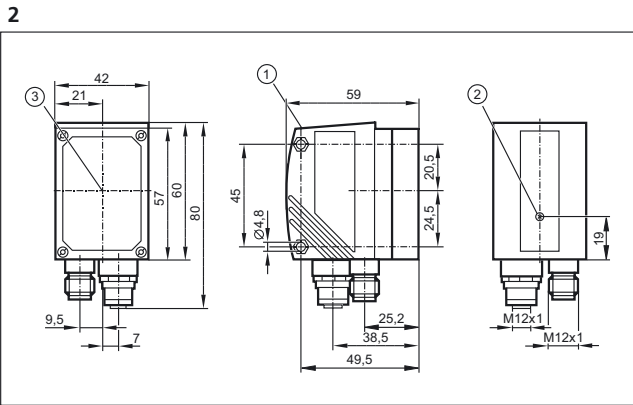

1: display, 2: Focus adjustment screw, 3: Centre of the lens axes

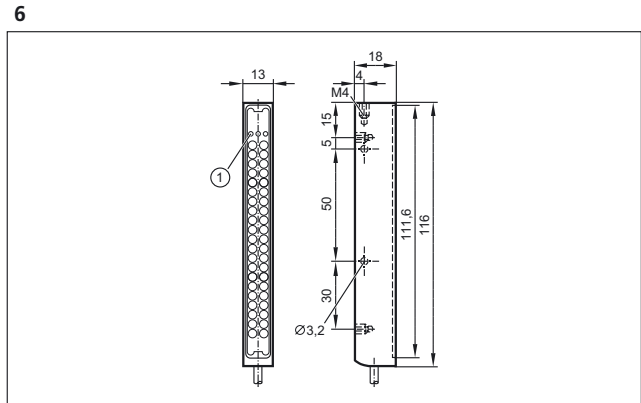
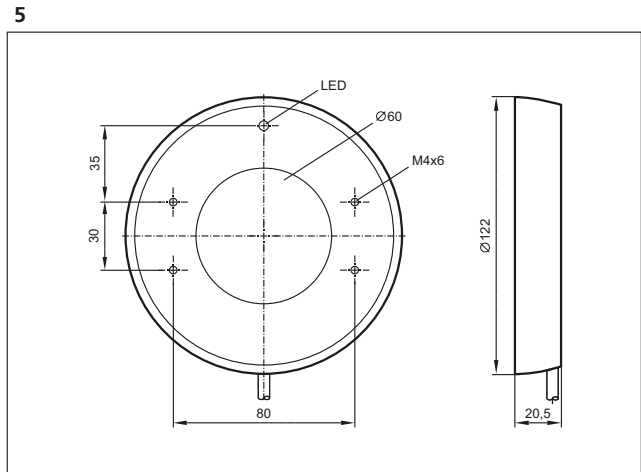
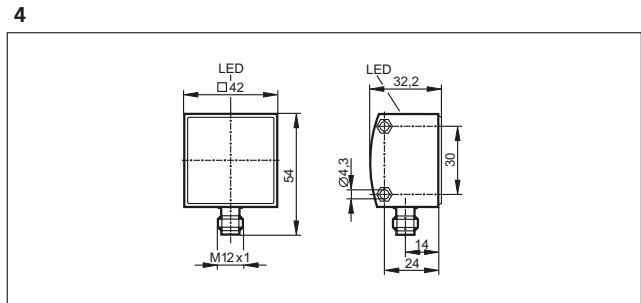
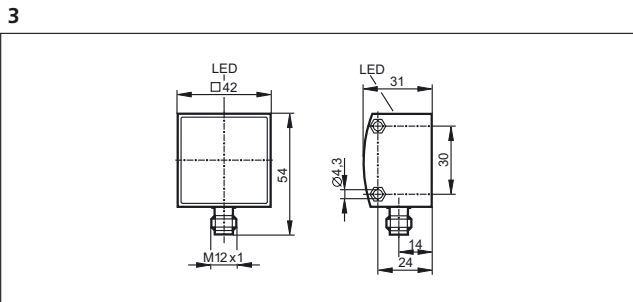

3 LED

Scale drawings / drawing no. – CAD download: www.ifm.com

7

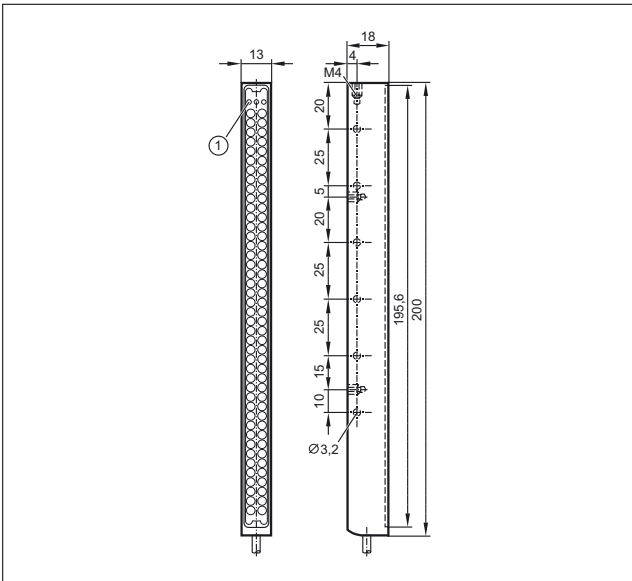

3 LED



Condition monitoring made transparent



Condition monitoring on a machine tool.



Condition-based monitoring of plant and assets has been shown to be the most cost effective strategy for ensuring high production efficiency. Timely intervention based on good information is the key. Too much and too early is wasteful, too little and too late means long unscheduled stoppages and even collateral damage.

Continuous vibration monitoring

Vibration monitoring offers a key indicator of plant condition, forming a core part of any CBM strategy. Typically used on rotating equipment such as fans, pumps, large motors, gear boxes and so on the cost effective octavis units from ifm allow permanent monitoring to be added not only to critical assets but to any piece of plant.

Consumption of compressed air

Compressed air is one of the most expensive energy carriers in the world. efactor metris monitors compressed air and specialty gases to detect leakage areas and improve energy efficiency. By identifying leakage areas, efactor metris can optimize compressed air and gas usage, improve system performance and reduce energy costs.

Flow at a glance

The use of liquid coolants has a direct influence on the quality of the end product. It is therefore important to monitor the coolant flow to improve efficiency and reduce costs.





The SM magmeter efactor mid which also measures the medium temperature is a cost-effective solution with high benefits. The unit also has a KTW approval which makes it suitable for use in drinking water.

Oil quality sensor

Excessive water content in oil causes damage to plant, reduces plant efficiency and shortens the useful life of the oil. The LDH sensor from ifm measures the oil humidity and generates an analogue signal across the 0...100 % humidity range.

An additional analogue output for temperature allows the asset manager to choose values at which action can be taken to minimise any damage.

For more product information we refer you to www.ifm.com

	<i>Vibration monitoring systems</i>	664 - 669
	<i>Flow meters for compressed air</i>	670 - 671
	<i>Flow meters for water</i>	672 - 676
	<i>Systems for oil quality monitoring</i>	678 - 680



Vibration monitoring systems

efector octavis is a simple to implement vibration monitoring system which detects vibration data and automatically determines the machine diagnosis directly on the machine.

The machine condition is forwarded to the PLC or to SCADA systems.

It fulfils the main requirements for modern machine monitoring: compatibility, modularity, and transferable configuration.

System overview	Page
Vibration sensors for vibration monitoring of machines and plants to ISO 10816 type VK	664
Accessories VK	665
Vibration transmitters for vibration monitoring of machines and plants to ISO 10816 type VT	665
Vibration transmitter with ATEX approval 3D/3G	665
Compact vibration sensors type VN	665
Accessories VN	665 - 666
Diagnostic electronics – control cabinet modules for vibration diagnosis type VSE	666
Accessories VSE	666
Connection cables VSE	666 - 667
Vibration sensors for connection to external diagnostic electronics VSE – type VSA / VSP	667
Accessories VSA	667
Scale drawings / drawing no. – CAD download: www.ifm.com	668 - 669

Vibration sensors for vibration monitoring of machines and plants to ISO 10816 type VK

Type	Description	Draw- ing no.	Order no.
	Vibration monitor to DIN ISO 10816 · Measuring range RMS: 0...25 mm/s · Switching output NC DC PNP and analogue output 4...20 mA · 2 Inputs / outputs total · Measuring range 0...25 RMS mm/s · Frequency range 10...1000 Hz · Ambient temperature -30...125 °C · M12 connector · Operating voltage 18...32 V DC · IP 67	1	VKV021
	Vibration monitor to DIN ISO 10816 · Measuring range RMS: 0...50 mm/s · Switching output NC DC PNP and analogue output 4...20 mA · 2 Inputs / outputs total · Measuring range 0...50 RMS mm/s · Frequency range 10...1000 Hz · Ambient temperature -30...125 °C · M12 connector · Operating voltage 18...32 V DC · IP 67	1	VKV022

Accessories VK

Type	Description	Order no.
	Protective cover · with lead seal option · for pressure sensors type PK · for temperature sensors type TK · for vibration sensors type VK · Housing materials: PP transparent	E30094

Vibration transmitters for vibration monitoring of machines and plants to ISO 10816 type VT

Type	Description	Draw- ing no.	Order no.
	Vibration transmitter to ISO 10816 · Measuring range RMS: 0...25 mm/s · Analogue output 4...20 mA · 2-wire connection technology · 1 Inputs / outputs total · Frequency range 10...1000 Hz · Ambient temperature -30...125 °C · M12 connector · Operating voltage 9.6...32 V DC · IP 67 / IP 68 / IP 69K	2	VTV122
	Vibration transmitter to ISO 10816 · Measuring range RMS: 0...50 mm/s · Analogue output 4...20 mA · 2-wire connection technology · 1 Inputs / outputs total · Frequency range 10...1000 Hz · Ambient temperature -30...125 °C · M12 connector · Operating voltage 9.6...32 V DC · IP 67 / IP 68 / IP 69K	2	VTV121



Vibration transmitter with ATEX approval 3D/3G

Type	Description	Draw- ing no.	Order no.
	Vibration transmitter to ISO 10816 · Measuring range RMS: 0...25 mm/s · Analogue output 4...20 mA · 2-wire connection technology · ATEX approval · Group II, category 3D/3G · 1 Inputs / outputs total · Frequency range 10...1000 Hz · Ambient temperature -20...60 °C · M12 connector · Operating voltage 9.6...32 V DC · IP 67	2	VTV12A

Compact vibration sensors type VN



Type	Description	Draw- ing no.	Order no.
	Vibration sensor to ISO 10816 · Parameter setting via pushbuttons · 3 Inputs / outputs total, configurable · Analogue input 4...20 mA · Measuring range 0...500 mm/s · Frequency range 2...1000 Hz · 4-digit alphanumeric display · Ambient temperature -30...60 °C · M12 connector · M8 connector · Operating voltage 9.6...30 V DC · IP 67	3	VNB001

Accessories VN



Type	Description	Order no.
	USB adapter cable · straight / straight · USB adapter cable and history tool for VNB001 · 5 m	E30136
	Adapter · UNF-M5 · Housing materials: stainless steel	E30137

Type	Description	Order no.
	Power supply · 2 m · Housing materials: PPE	E30080

Diagnostic electronics – control cabinet modules for vibration diagnosis type VSE

Type	Description	Draw- ing no.	Order no.
	Diagnostics electronics for vibration sensors type VSA / VSP · Mounting on DIN rail · 4 sensor inputs 0...10 mA or IEPE · TCP/IP Ethernet interface · Frequency-selective machine monitoring of up to 4 measuring points · Integrated history memory with real-time clock · Counter function · 6 Inputs / outputs total, configurable · Analogue input 0...10 mA / IEPE · Ambient temperature 0...70 °C · Operating voltage 24 V DC ± 20 % · IP 20	4	VSE002
	Diagnostic electronics for vibration sensors · Mounting on DIN rail · Integrated history memory with real-time clock · Counter function · TCP/IP Ethernet interface · Active wire break detection and self-test (only MEMS) of the connected acceleration sensors · Parameter setting via PC software VES004 · 16 Inputs / outputs total, configurable · Ambient temperature 0...70 °C · Operating voltage 24 V DC ± 20 % · IP 20	5	VSE100

Accessories VSE









Type	Description	Number of connections	Order no.
	Parametriersoftware für VSExxx und VNBxxx	–	VES004
	octavis OPC server · Software · German/English	25	VOS001
	octavis OPC server · Software · German/English	50	VOS002
	octavis OPC server · Software · German/English	75	VOS003
	octavis OPC server · Software · German/English	100	VOS004
	octavis OPC server · Software · German/English	1000	VOS005

Connection cables VSE

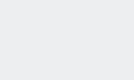

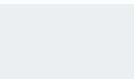
Type	Description	Order no.
	Jumper · straight / straight · Ethernet · Cross-over patch cable · 5 m · Housing materials: PUR	E30112

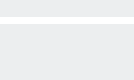
Type	Description	Order no.
	Jumper · straight / straight · Ethernet · Cross-over patch cable · 2 m · Housing materials: PUR	EC2080

Vibration sensors for connection to external diagnostic electronics VSE – type VSA / VSP

Type	Description	Drawing no.	Order no.
	Accelerometer · for connection to external diagnostic electronics type VSE · Measuring range ± 25 g · Frequency range 0...6000 Hz · Ambient temperature -30...125 °C · M12 connector · Operating voltage 7.2...10.8 V DC · IP 68 / IP 69K	6	VSA001
	Accelerometer · for connection to external diagnostic electronics type VSE · Measuring range ± 3.3 g · Frequency range 0...1000 Hz · Ambient temperature -30...125 °C · M12 connector · Operating voltage 9 V DC · IP 68 / IP 69K	6	VSA101
	Accelerometer · for connection to external diagnostic electronics type VSE · Measuring range ± 250 g · Frequency range 0...6000 Hz · Ambient temperature -30...125 °C · M12 connector · Operating voltage 9 V DC · IP 68 / IP 69K	6	VSA201
	Accelerometer · for connection to external diagnostic electronics type VSE · Measuring range ± 25 g · Frequency range 0...10000 Hz · Ambient temperature -30...85 °C · PUR cable with M12 connector, 0.8 m · Operating voltage 9 V DC · IP 67	7	VSA002
	Accelerometer · for connection to external diagnostic electronics type VSE · Measuring range ± 25 g · Frequency range 0...10000 Hz · Ambient temperature -30...85 °C · PUR cable, 6 m · Operating voltage 9 V DC · IP 67	7	VSA006
	Accelerometer · for connection to external diagnostic electronics type VSE · Measuring range ± 25 g · Frequency range 0...10000 Hz · Ambient temperature -30...100 °C · PUR cable, 3 m · Operating voltage 9 V DC · IP 67	8	VSA004
	Accelerometer · for connection to external diagnostic electronics type VSE · Measuring range ± 25 g · Frequency range 0...10000 Hz · Ambient temperature -30...100 °C · PUR cable, 10 m · Operating voltage 9 V DC · IP 67	8	VSA005
	Accelerometer · for connection to external diagnostic electronics type VSE · Measuring range ± 50 g · Frequency range 2...10000 $\pm 5\%$ Hz · Ambient temperature -55...125 °C · M12 connector · Operating voltage 10...12 V DC · IP 67	9	VSP001
	Accelerometer · ATEX approval · Group II, category 1D · Group II, category 1G · For connection to VSExxx type external diagnostic electronics via safety barrier · Measuring range ± 80 g · Frequency range 2...10000 Hz · Ambient temperature -55...90 °C · PUR cable, 10 m · Operating voltage 10...12 V DC · IP 68	10	VSP01A
	Accelerometer · ATEX approval · group 1, M1 · For connection to VSExxx type external diagnostic electronics via safety barrier · Measuring range ± 80 g · Frequency range 2...10000 Hz · Ambient temperature -55...90 °C · PUR cable, 10 m · Operating voltage 10...12 V DC · IP 68	10	VSP02A

Accessories VSA

Type	Description	Order no.
	conical washer · $\varnothing 8.4 / 15$ mm · for vibration sensors VSA001, VSA101, VSA201 · Housing materials: stainless steel 316Ti / 1.4571	E30115
	Adapter · M8-M8 · for vibration sensors VSA001, VSA101, VSA201 · Electrical isolation · Housing materials: PEEK	E30132

Scale drawings / drawing no. – CAD download: www.ifm.com

1

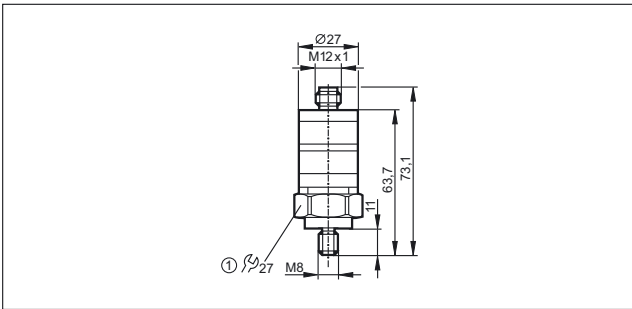

1: tightening torque 15 Nm

2

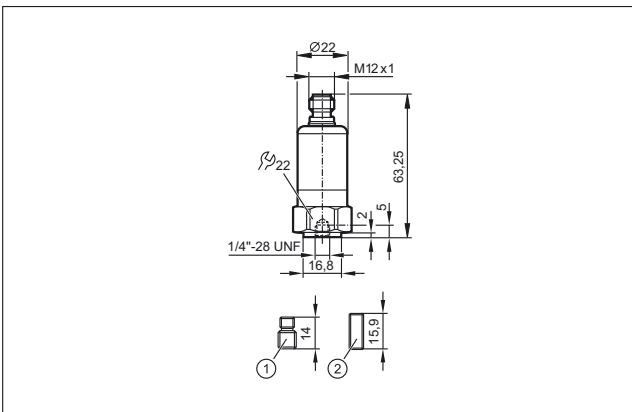

1: Threaded adapter 1/4" -28 UNF / M8 x 1.25 mm, 2: Threaded adapter 1/4" -28 UNF, tightening torque 8 Nm

3

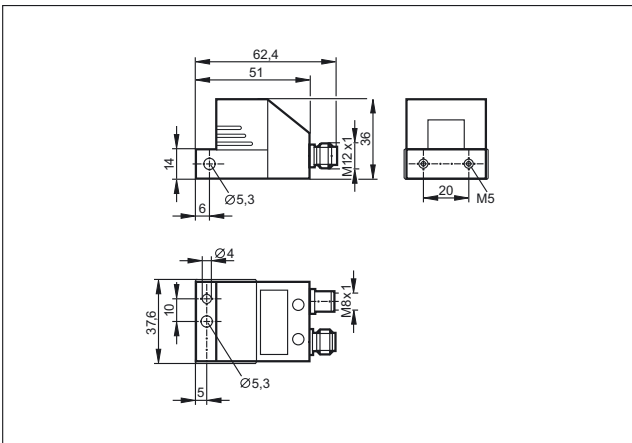

4

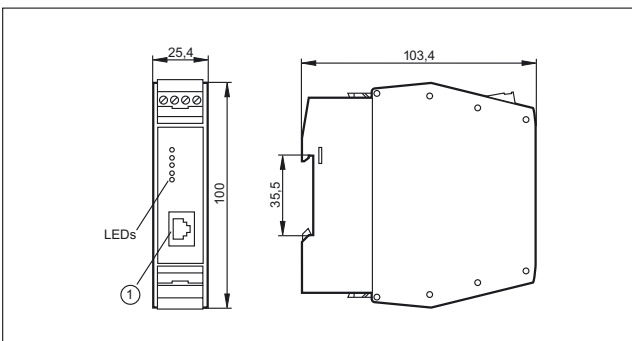

1: Ethernet interface

5

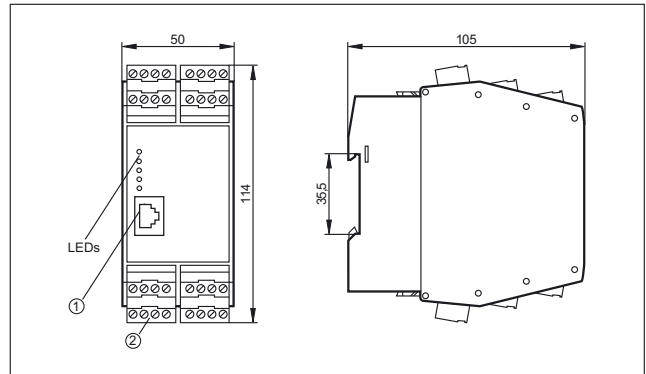

1: Ethernet interface, 2: Combi-con plug with screw terminals (optional)

6

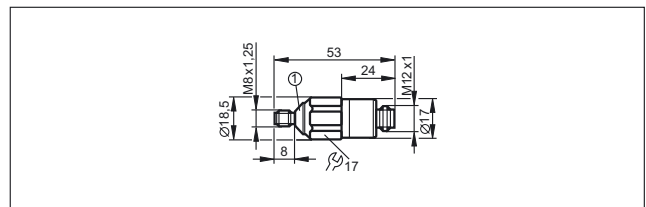

1: conical angle = 90°

7

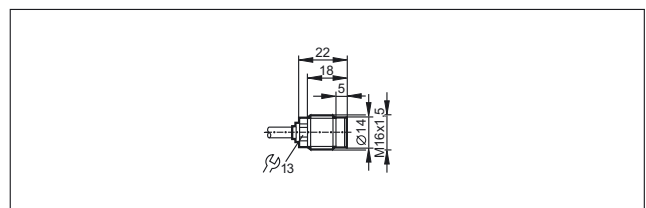

8

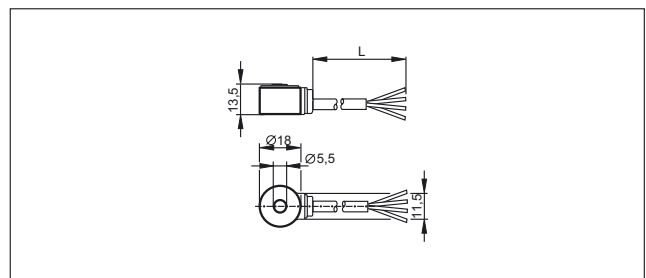

9

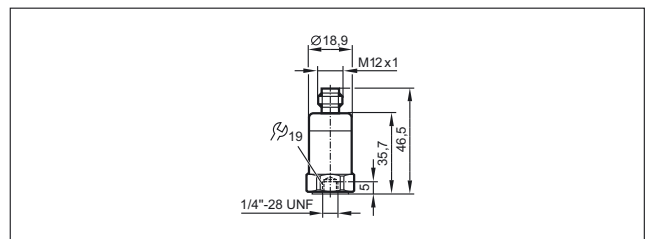

Scale drawings / drawing no. – CAD download: www.ifm.com

10

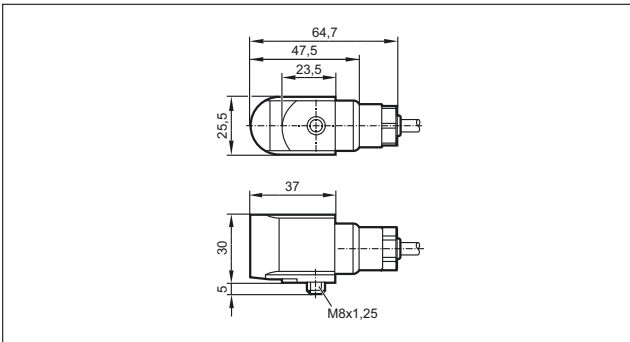



Flow meters for compressed air

efector metris is used to measure the consumption of compressed air. The high measurement dynamics in conjunction with high measurement accuracy and a fast response time result in an application range from leakage detection to operational measurement of consumption. Many possibilities of supplying the values measured for current and temperature allow almost universal coupling to process or control systems.

System overview	Page
Compressed air meters	670
Wiring diagrams	671
Scale drawings / drawing no. – CAD download: www.ifm.com	671

Compressed air meters

Type	Process connection	Setting range [Nm ³ /h]	Pressure rating [bar]	Response time [s]	U _b [V]	Draw- ing no.	Order no.
------	--------------------	---------------------------------------	--------------------------	----------------------	-----------------------	---------------------	--------------

Output function OUT1: normally open / closed programmable or pulse OUT2: normally open / closed programmable or analogue (4...20 mA scaleable) · Wiring diagram no. 1 · Connector groups 8, 10, 18, 20, 120, 124, 126, 128, 157

	G ¼ (DN8)	0.12...15.00	16	< 0.1	18...30	1	SD5000
	R½ (DN15)	0.6...75.0	16	< 0.1	18...30	2	SD6000
	G ½ (DN15)	0.6...75	16	< 0.1	18...30	3	SD6050
	R1 (DN25)	1.8...225.0	16	< 0.1	18...30	4	SD8000
	R1½ (DN40)	3.5...410.0	16	< 0.1	18...30	5	SD9000
	R2 (DN50)	5...700	16	< 0.1	18...30	6	SD2000

Output function OUT1: normally open / closed programmable or pulse OUT2: normally open / closed programmable or analogue (4...20 mA scaleable) · Wiring diagram no. 2 · Connector groups 8, 10, 18, 20, 120, 124, 126, 128, 157

	G 1 1	18...2110	16	< 0.1	18...30	7	SD0523
--	-------	-----------	----	-------	---------	---	--------

Wiring diagrams

Core colours

BK	black
BN	brown
BU	blue
WH	white

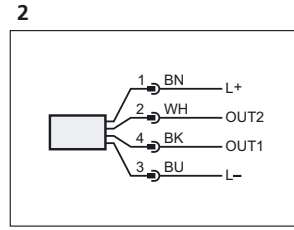
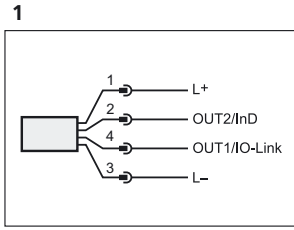

Scale drawings / drawing no. – CAD download: www.ifm.com

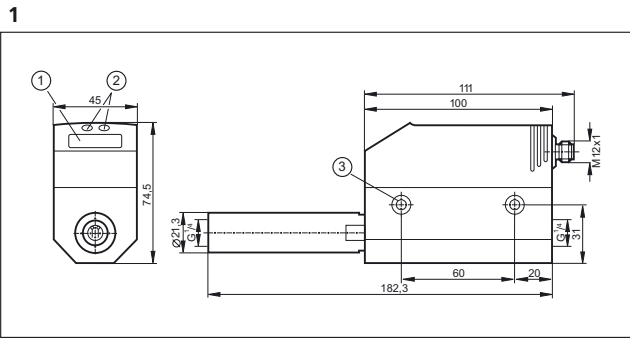

1: 4-digit alphanumeric display, 2: Programming buttons, 3: hole for M5 fixing screw

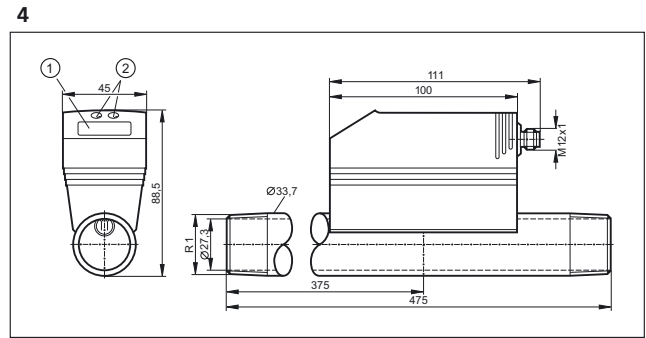

1: 4-digit alphanumeric display, 2: Programming buttons

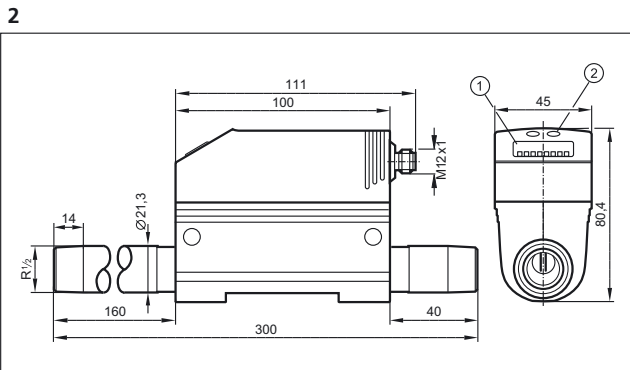

1: 4-digit alphanumeric display, 2: Programming buttons

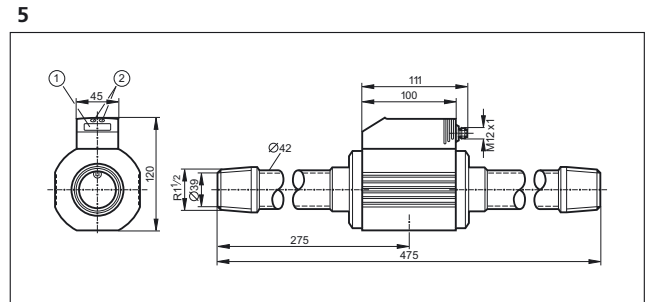

1: 4-digit alphanumeric display, 2: Programming buttons

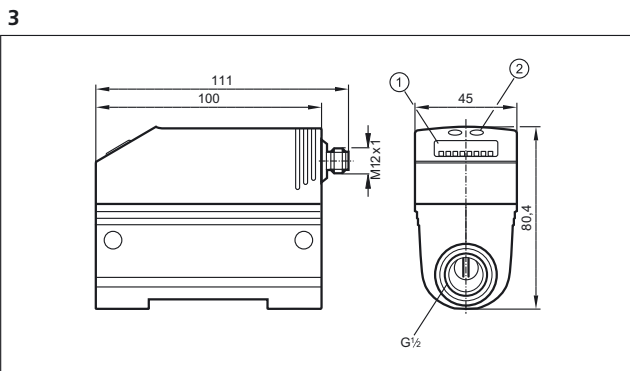

1: 4-digit alphanumeric display, 2: Programming buttons

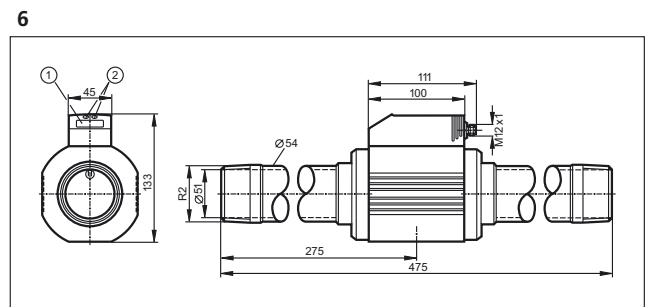

1: 4-digit alphanumeric display, 2: Programming buttons

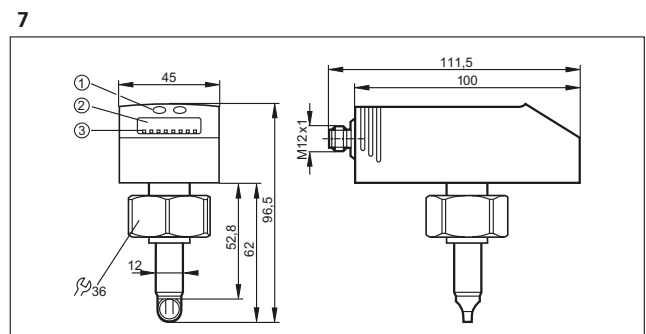

1: Programming buttons, 2: 4-digit alphanumeric display, 3: LEDs



Flow meters for water

Efforts to reduce water consumption presuppose knowledge of the current consumption. Measuring systems such as magnetic-inductive or ultrasound flow meters can also be used for applications in drinking water circuits due to their compact design. The use in drinking water supply is ensured by the use of approved materials. Many possibilities of supplying the values measured for current and temperature allow almost universal coupling to process or control systems.

System overview	Page
Magnetic-inductive flow meters with integrated temperature monitoring (sealing material EPDM) KTW / W270 approval	672
Ultrasonic flow meters for liquids (water, glycol solutions, oils)	673
Accessories for flow meters	673 - 675
Grounding clamps for magnetic-inductive flow meters	675
Wiring diagrams	675
Scale drawings / drawing no. – CAD download: www.ifm.com	676

Magnetic-inductive flow meters with integrated temperature monitoring (sealing material EPDM) KTW / W270 approval

Type	Process connection	Measuring range [l/min]	Medium temperature [°C]	Pressure rating [bar]	Response time [s]	U _b [V]	Drawing no.	Order no.
------	--------------------	-------------------------	-------------------------	-----------------------	-------------------	--------------------	-------------	-----------

Output function OUT1: normally open / normally closed programmable or pulse or frequency or empty pipe detection or IO-Link
 OUT2: normally open / normally closed programmable or analogue (4...20 mA; 0...10 V, scalable) or empty pipe detection ·
 Wiring diagram no. 1 · Connector groups 8, 10, 12, 13, 18, 19, 20, 21, 120, 122, 124, 126, 128, 130, 132, 157, 159

	G2 flat seal	8...600	-10...70	16	< 0.35	18...32	1	SM2100
---	--------------	---------	----------	----	--------	---------	---	--------

Output function OUT1: normally open / closed programmable or pulse OUT2: normally open / closed programmable or analogue (4...20 mA / 0...10 V, scaleable) · Wiring diagram no. 1 · Connector groups 8, 10, 18, 20, 120, 124, 126, 128, 157

	G½	0.25...25.00	-10...70	16	< 0.150	19...30	2	SM6100
---	----	--------------	----------	----	---------	---------	---	--------

	G¾	0.5...50.0	-10...70	16	< 0.150	19...30	3	SM7100
---	----	------------	----------	----	---------	---------	---	--------

	G1	0.7...100.0	-10...70	16	< 0.150	19...30	4	SM8100
---	----	-------------	----------	----	---------	---------	---	--------



Output function OUT1: normally open / normally closed programmable or pulse or frequency or empty pipe detection or IO-Link
 OUT2: normally open / normally closed programmable or analogue (4...20 mA; 0...10 V, scalable) or empty pipe detection ·
 Wiring diagram no. 1 · Connector groups 8, 10, 12, 13, 18, 19, 20, 21, 120, 122, 124, 126, 128, 130, 132, 157, 159

	G2 flat seal	6.5...300	-10...70	16	< 0.35	18...32	1	SM9100
---	--------------	-----------	----------	----	--------	---------	---	--------



Ultrasonic flow meters for liquids (water, glycol solutions, oils)

Type	Process connection	Measuring range [l/min]	Medium temperature [°C]	Pressure rating [bar]	Response time [s]	U _b [V]	Drawing no.	Order no.
------	--------------------	----------------------------	----------------------------	--------------------------	----------------------	-----------------------	-------------	-----------

Output function 2 x normally open / closed programmable · Wiring diagram no. 2 · Connector groups 8, 10, 18, 20, 120, 124, 126, 128, 157

	G $\frac{3}{4}$	0.1...50.0	-10...80	16	< 0.250	19...30	5	SU7200
	G1	0.2...100.0	-10...80	16	< 0.250	19...30	6	SU8200

Output function OUT1: normally open / closed programmable or pulse OUT2: normally open / closed programmable or analogue (4...20 mA / 0...10 V, scaleable) · Wiring diagram no. 3 · Connector groups 8, 10, 18, 20, 120, 124, 126, 128, 157











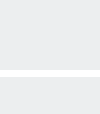

	G $\frac{3}{4}$	0.1...50.0	-10...80	16	< 0.250	19...30	5	SU7000
	G1	0.2...100.0	-10...80	16	< 0.250	19...30	6	SU8000
	G1 $\frac{1}{4}$	0.4...200.0	-10...80	16	< 0.250	19...30	7	SU9000

Output function 2 x analogue (4...20 mA scaleable) · Wiring diagram no. 4 · Connector groups 8, 10, 18, 20, 120, 124, 126, 128, 157

	G1 $\frac{1}{4}$	0.0...200.0	-10...80	16	< 0.250	19...30	7	SU9004
---	------------------	-------------	----------	----	---------	---------	---	--------

Accessories for flow meters

Type	Description	Order no.
	Adapter · G $\frac{1}{2}$ - R $\frac{1}{2}$ · for flow monitor type SM6 · flat seal · Housing materials: stainless steel 316Ti / 1.4571	E40199
	Adapter · G $\frac{1}{2}$ - G $\frac{3}{4}$ · for flow monitor type SM6 · flat seal · Housing materials: stainless steel 316L / 1.4404	E40189
	Adapter · G $\frac{3}{4}$ - R $\frac{1}{2}$ · for flow monitor type SM7 / SU7 · Housing materials: stainless steel 316L / 1.4404	E40178
	Adapter · G 1 - R $\frac{1}{2}$ · for flow monitor type SM8 / SU8 · Housing materials: stainless steel 316L / 1.4404	E40179
	Adapter · G 1 - R $\frac{3}{4}$ · for flow monitor type SM8 / SU8 · Housing materials: stainless steel 316L / 1.4404	E40180

Type	Description	Order no.
	Adapter · G 3/4 - R 1/2 · for flow monitor type SM7 / SU7 · Housing materials: Brass	E40151
	Adapter · Victaulic · for flow sensors type SM2, SM9 · Housing materials: stainless steel 316Ti / 1.4571	E40227
	Adapter · 2" NPT · for flow sensors type SM2, SM9 · Housing materials: stainless steel 316Ti / 1.4571	E40228
	Adapter · R 2" A · for flow sensors type SM2, SM9 · Housing materials: stainless steel 316Ti / 1.4571	E40231
	Adapter · 1 1/2" NPT · for flow sensors type SM2, SM9 · Housing materials: stainless steel 316Ti / 1.4571	E40229
	Adapter · G 1 1/2 · for flow sensors type SM2, SM9 · Housing materials: stainless steel 316Ti / 1.4571	E40230
	Adapter · G 1 - R 3/4 · for flow monitor type SM8 / SU8 · Housing materials: Brass	E40153
	Adapter · G 1 1/4 - R 1 · for flow monitor type SU9 · Housing materials: stainless steel 316L / 1.4404	E40205
	Adapter · G 1/2 - G 1/2 · for flow monitor type SM6 · Housing materials: stainless steel 316L / 1.4404	E40213
	Adapter · G 3/4 - G 1/2 · for flow monitor type SM7 / SU7 · Housing materials: stainless steel 316L / 1.4404	E40214
	Adapter · G 1 - G 3/4 · for flow monitor type SM8 / SU8 · Housing materials: stainless steel 316L / 1.4404	E40215
	Adapter · G 3/4 - G 3/4 · for flow monitor type SM7 / SU7 · Housing materials: stainless steel 316L / 1.4404	E40216
	Adapter · G 1 - G 1 · for flow monitor type SM8 / SU8 · Housing materials: stainless steel 316L / 1.4404	E40217
	Adapter · G 1 1/2 · for flow sensors type SM2, SM9 · Housing materials: stainless steel 316Ti / 1.4571	E40230
	Adapter · R 2" A · for flow sensors type SM2, SM9 · Housing materials: stainless steel 316Ti / 1.4571	E40231

Type	Description	Order no.
	Flange adapter · Adapter · rotatable · for type SM2, SM9 · Housing materials: flange: stainless steel / adapter: stainless steel 316Ti / 1.4571 / O-ring: EPDM	E40240

Grounding clamps for magnetic-inductive flow meters

Type	Description	Order no.
	Grounding clamp · Housing materials: stainless steel 316L / 1.4404	E40234

Wiring diagrams

Core colours

BK	black
BN	brown
BU	blue
WH	white

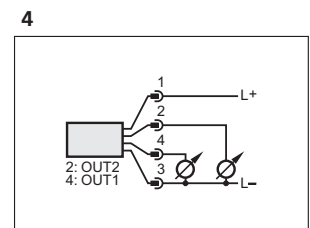
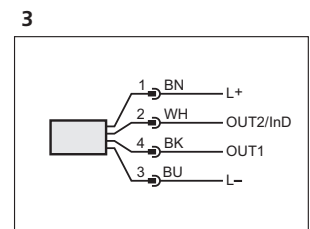
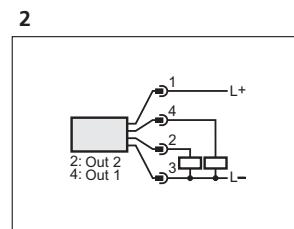
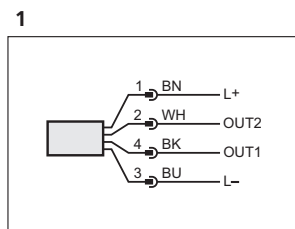

Scale drawings / drawing no. – CAD download: www.ifm.com

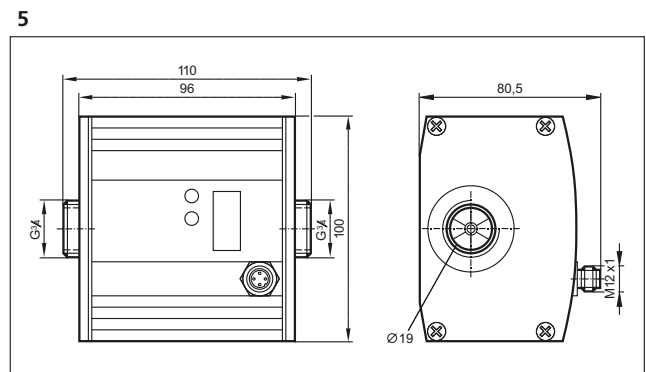
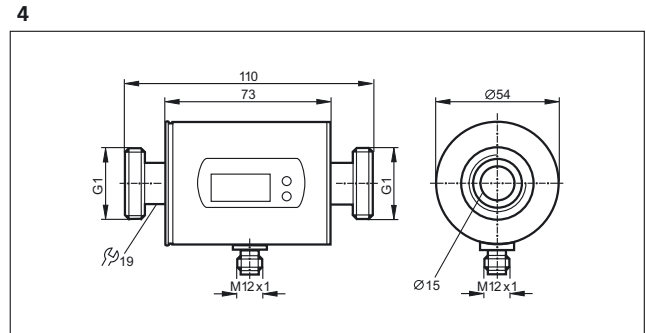
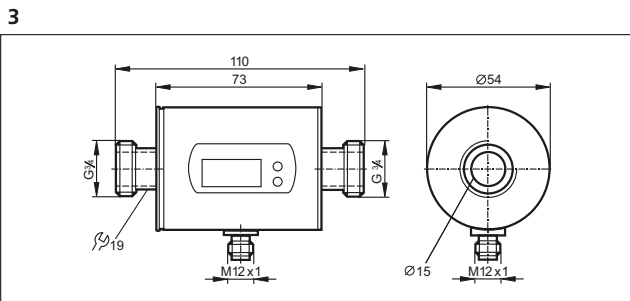
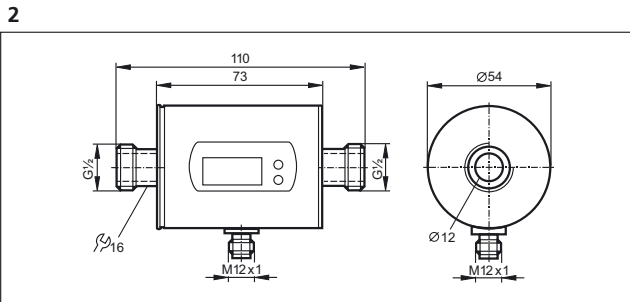
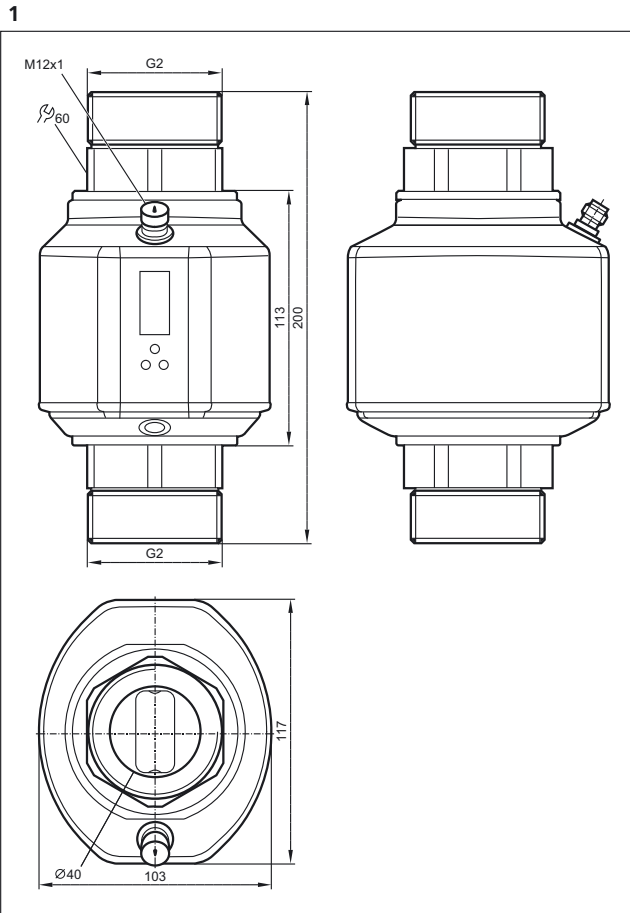

installation length with pipe adapter E40151 / E40154: 185 mm

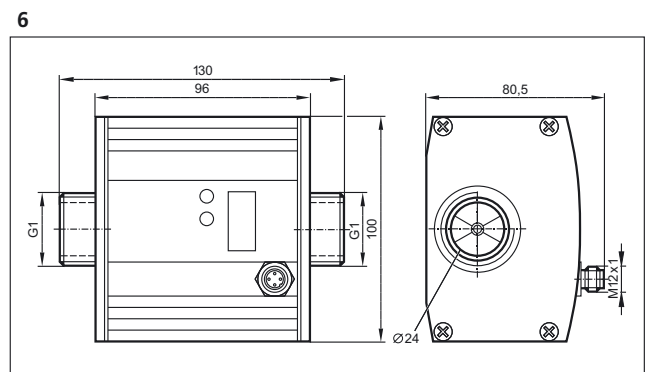

installation length with pipe adapter E40152 / E40155: 205 mm,
installation length with pipe adapter E40153 / E40156: 215 mm

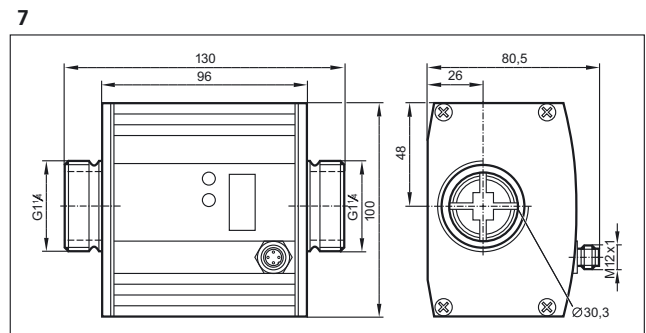





Systems for oil quality monitoring

For an early detection of too high a water content in lubricants and oils it is useful to continuously monitor the relative moisture in the media using a sensor. The sensor measures the relative moisture in the oil in the range of 0...100 % by means of a capacitive measuring element. Besides the relative moisture the sensor also provides the medium temperature as an analogue signal. LDP100 monitors the degree of cleanliness or the level of contamination in fluids. Compatible media are mineral oils, ester oils and biodegradable oils. The calibration is made in accordance with ISO 11943. The purity classes are indicated on the LCD display and provided via analogue output and CAN bus

System overview	Page
Oil particle sensor	678
Oil moisture sensor	678
Accessories for LDP oil particle monitor	679
Accessories for oil moisture sensor LDH	679
Wiring diagrams	679
Scale drawings / drawing no. – CAD download: www.ifm.com	680

Oil particle sensor

Type	Process connection	Pressure rating [bar]	Protection	Medium temperature oil [°C]	Ambient temperature [°C]	Drawing no.	Order no.
M12 connector · Output function 4...20 mA (can be configured); digital alarm output · Wiring diagram no. 1 · Connector groups 14, 15, 16, 17							
	Minimes M16 x 2	420	IP 67	-10...80	-10...60	1	LDP100

Oil moisture sensor

Type	Process connection	Pressure rating [bar]	Protection	Medium temperature oil [°C]	Ambient temperature [°C]	Drawing no.	Order no.
M12 connector · Output function 4...20 mA analogue · Wiring diagram no. 2 · Connector groups 15, 16, 17							
	G 3/4	50	IP 67	-20...100	-20...85	2	LDH100

Accessories for LDP oil particle monitor

Type	Description	Order no.
	Screw couplings with cover plate · Blende 0.18 mm · Housing materials: socket housing: steel / surface characteristics: zinc/nickel grey / sealing: NBR	E43330
	Screw couplings with cover plate · Blende 0.3 mm · Housing materials: socket housing: steel / surface characteristics: zinc/nickel grey / sealing: NBR	E43331
	Jumper · straight / straight · CAN adapter cable: M12 plug, 5-pole / M12 socket, 8-pole · Gold-plated contacts · 0.15 m · Housing materials: PUR	E43332
	BasicDisplay · 2.8" colour display · 5 freely programmable backlit function keys · Navigation key for cursor function · CAN interface · Programming according to IEC 61131-3 · 8...32 V DC	CR0451

Accessories for oil moisture sensor LDH

Type	Description	Order no.
	Adapter block · D33 / G 3/4 · for oil moisture sensor LDH100 · Housing materials: aluminium	E43400

Wiring diagrams

1

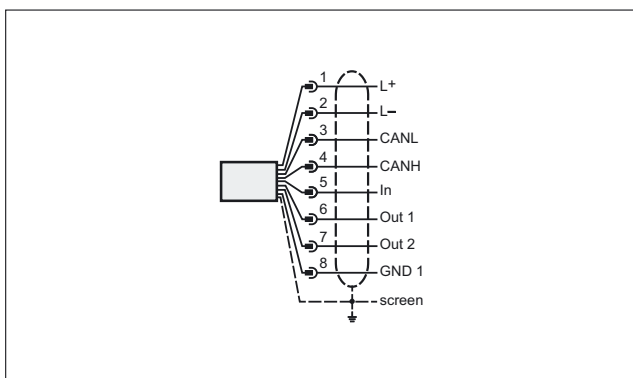

2

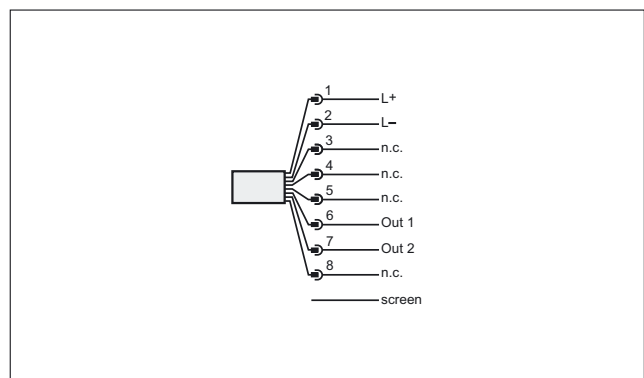

In: Switching input (low level activates measuring cycle), Out 1: Analogue output, Out 2: Switching output, GND 1: Signal ground
Out 1

Scale drawings / drawing no. – CAD download: www.ifm.com

1

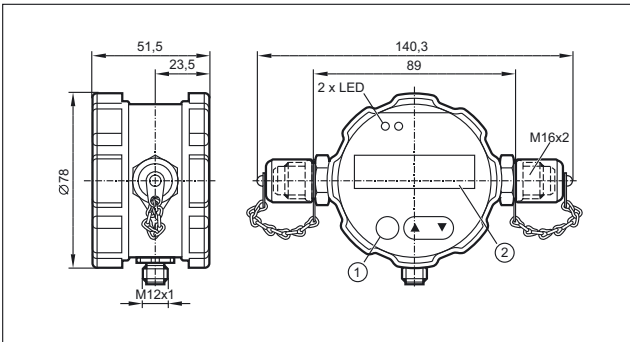

1: Programming buttons, 2: display

2

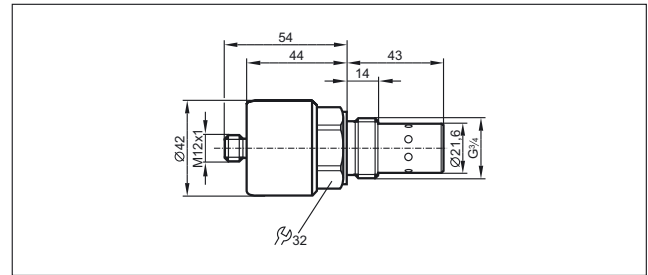



For mobile applications



Extreme shock and vibration: Reliable function of the sensitive electronics must be guaranteed under harsh operating conditions as well.



Control technology for mobile applications

Life today cannot be imagined without electronics in modern motor vehicles and mobile machines. Many necessary and convenient functions could not be implemented without electronic support. In contrast to electronics in consumer goods and "normal" industrial applications such as packaging machines and conveyors the requirements for components for mobile applications are much higher.

Electronic requirements

The components need to be carefully selected, mainly because of the extreme mechanical stress caused by impacts and shocks and the use at extreme operating temperatures. The direct influence of dirt, humidity and water often cannot be excluded in field applications. Therefore a high protection rating and a special selection of the materials are required for the devices.

In addition to mechanical and environmental influences, electrical interference affecting the whole system as well as individual devices, have to be taken into account. A wide supply voltage range and well-adapted protective measures ensure safe operation of the devices even in case of large voltage fluctuations by the battery / generator system. Strong conducted or radiated interference must not influence the function either.

For device networking the CAN bus has become the successful standard in the last few years. Whereas for the high volume production of passenger cars special, optimised and well-adapted protocols are used, the CANopen protocol has become indispensable in mobile machines. Manufacturer and industry-specific protocols, such as diagnostic engine data according to SAE J 1939, can be coupled to the machine process via gateways.

	Basic control systems	684 - 689
	Mobile controllers	690 - 696
	I/O modules	698 - 703
	Dialogue modules / displays	704 - 707
	Cameras	708 - 712
	Diagnostic and service units	714 - 716
	Signal converters	718 - 719
	Sensors	720 - 735



Basic control systems





The ecomat*mobile* Basic control system has a modular design, is easy to install and to operate and is cost-optimised.

Besides pure control functions it provides solutions for wiring and protection.

In addition, a graphical visualisation module ensures the indication of system messages and simple display instruments.

System overview	Page
BasicController	684
Starter set ecomatmobile Basic	685
BasicRelay	685
BasicDisplay	685
BasicDisplay XL	685
Accessories for the mini control system Basic	685 - 688
Scale drawings / drawing no. – CAD download: www.ifm.com	688 - 689

BasicController

Type	Inputs / outputs total	Inputs	Outputs	Interfaces	Drawing no.	Order no.
Configurable input / output functions, Programming according to IEC 61131-3						
	20	12 x Digital 4 x analogue (U/I) 4 x frequency 4 x Resistor	8 x Digital 8 x PWM	2 x CAN	1	CR0401
	24	12 x Digital 4 x analogue (U/I) 4 x frequency 4 x Resistor	12 x Digital 2 x PWM-I 10 x PWM	2 x CAN	2	CR0403
	16	8 x Digital 4 x analogue (U/I) 4 x frequency 4 x Resistor	8 x Digital 8 x PWM-I 8 x PWM 4 x H bridge	2 x CAN	3	CR0411
	14	8 x Digital 4 x analogue (U/I) 4 x frequency 4 x Resistor	6 x Relay	2 x CAN	4	CR0431

Starter set ecomatmobile Basic

Type	Description	Order no.
	Starter set ecomatmobile Basic	EC0400

BasicRelay

Type	Inputs / outputs	Description	Draw- ing no.	Order no.
	-	BasicRelay · Locations for 6 automotive relays and 10 automotive fuses ((6.3 mm) · 2 supply rails and 6 power distributors · freely wirable	5	CR0421



BasicDisplay

Type	Display	Operating elements	Inputs / outputs	Interfaces	Draw- ing no.	Order no.
5 freely programmable backlit function keys, Programming according to IEC 61131-3 · M12 connector						
	2.8" colour display 320 x 240 pixels	5 Pushbuttons 1 Navigation key for cursor function	-	1 x CAN	6	CR0451











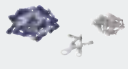

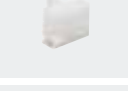
BasicDisplay XL



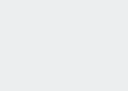

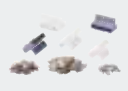
Type	Display	Operating elements	Inputs / outputs	Interfaces	Draw- ing no.	Order no.
6 freely programmable backlit function keys, Programming according to IEC 61131-3 · M12 connector						
	4.3" colour display 480 x 272 pixels	6 Pushbuttons 1 Navigation key for cursor function	-	1 x CAN	7	CR0452

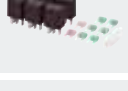
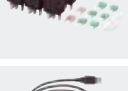
Accessories for the mini control system Basic

Type	Description	Order no.
	cover · for BasicController CR04xx and BasicRelay CR042x · incl. cable seal	EC0401
	cover · for BasicController CR04xx · Built-in display recess for BasicDisplay CR0451 · incl. cable seal	EC0402

Type	Description	Order no.
	Mounting frame · for BasicDisplay CR0451 · panel · Housing materials: stainless steel	EC0403
	Mounting frame · for BasicDisplay XL CR0452 · panel · Housing materials: stainless steel	EC0404
	RAM mount set · Ball size 1" (B) · e.g. for BasicDisplay · for use as a desktop unit · Housing materials: Mounting arm: aluminium black anodised / Mounting plate: aluminium black anodised / ball: rubber / Display carrier: plastics black	EC0405
	RAM mount set · Ball size 1" (B) · e.g. for BasicDisplay XL · for use as a desktop unit · Housing materials: Mounting arm: aluminium black anodised / Mounting plate: aluminium black anodised / ball: rubber / Display carrier: plastics black	EC0406
	Display carrier · RAM mount system · Ball size 1" (B) · e.g. for BasicDisplay · for use as a desktop unit · Housing materials: plastics black	EC0407
	Display carrier · RAM mount system · Ball size 1" (B) · e.g. for BasicDisplay XL · for use as a desktop unit · Housing materials: plastics black	EC0408
	Mounting plate · RAM mount system · Ball size 1" (B) · e.g. for BasicDisplay or BasicDisplay XL · for use as a desktop unit · Housing materials: Mounting plate: aluminium black anodised / ball: rubber	EC0409
	Mounting arm · 95 mm · RAM mount system · Ball size 1" (B) · e.g. for BasicDisplay or BasicDisplay XL · for use as a desktop unit · Housing materials: Mounting arm: aluminium black anodised	EC0410
	Socket · angled · Free from silicone · Free from halogen · Gold-plated contacts · M12 connector with integrated CAN terminating resistor (120 ohm) · 5 m · Housing materials: housing: TPU black / sealing: FKM	EVC492
	Jumper · wired · for 2 BasicControllers CR04xx · CAN interface · Power supply · 0.5 m	EC0451
	Jumper · wired · for 1 BasicController CR04xx and 1 BasicDisplay CR045x · CAN interface · Power supply · M12 connector · 0.1 m	EC0452
	Jumper · wired · for 2 BasicControllers CR04xx and 1 BasicDisplay CR045x · CAN interface · Power supply · M12 connector · 0.5 m	EC0453
	Jumper · wired · for 1 BasicController CR04xx and 1 BasicDisplay CR045x · CAN interface · Power supply · M12 connector · 5 m	EC0454
	Jumper · wired · for 1 BasicController CR04xx and 1 BasicDisplay CR045x · CAN interface · Power supply · M12 connector · 10 m	EC0458
	Jumper · wired · for 2 BasicControllers CR04xx and 1 BasicDisplay CR045x · CAN interface · Power supply · M12 connector · 5 m	EC0455

Type	Description	Order no.
	Contacts and contact housings · for BasicController CR04xx · wirable · utilising all connections to a BasicController	EC0456
	Set of contacts · for BasicRelay CR0421 · wirable · utilising all connections to a BasicRelay	EC0457
	Standard timer contact housing · for BasicController CR04xx · CAN1 and supply P/N1 · Coding · wirable · Housing materials: PA white	EC0460
	Standard timer contact housing · for BasicController CR04xx · CAN2 N2 · Coding · wirable · Housing materials: PA white	EC0461
	Standard timer contact housing · for BasicController CR04xx · Inputs A/B/C · Coding · wirable · Housing materials: PA grey	EC0462
	Standard timer contact housing · for BasicController CR04xx · Outputs D/E/F · Coding · wirable · Housing materials: PA white	EC0463
	Standard timer contact · for standard timer contact housing · 0.2...0.5 mm ² / Ø 1.0...1.6 mm · Housing materials: tin-plated	EC0459
	Standard timer contact · for standard timer contact housing · 0.5...1.0 mm ² / Ø 1.4...2.3 mm · Housing materials: tin-plated	EC0468
	Standard timer contact · for standard timer contact housing · 1.0...2.5 mm ² / Ø 2.1...3.1 mm · Housing materials: tin-plated	EC0469
	Standard power timer contact · for standard timer contact housing · 1.25...2.5 mm ² / Ø 2.1...3.1 mm · Housing materials: tin-plated	EC0470
	Contacts and contact housings · for BasicController relay CR0431 · wirable · utilising all connections to a BasicController relay	EC0464
	Connecting material for power supply · for BasicController relay CR0431 · wirable	EC0465
	Set of relays and fuses for 12 V DC systems · for BasicController relay CR0431	EC0466
	Set of relays and fuses for 24 V DC systems · for BasicController relay CR0431	EC0467
	CANfox · CAN/RS232-USB interface · Programming and diagnosis of CAN systems · 5 V DC (via USB interface)	EC2112

Type	Description	Order no.
	Adapter cable · for CAN interface CANfox · CAN adapter: DIN connector, 6 poles / M12 connector, 5 poles · RS-232 adapter: DIN connector, 6 poles / Sub-D plug, 9 poles · Cable length 1 m	EC2113
	Set of programming cables · for CAN interface CANfox · Cable BasicController: DIN connector, 6-pole / standard timer contact housing, 6-pole · Cable BasicDisplay: DIN connector, 6-pole / M12 socket, 5-pole · CAN interface · Voltage supply via individual wires with end ferrules · Cable length 1 m	EC2114
	Programming software CODESYS · for configuration, programming and diagnosis of ifm controller systems · German version · incl. the DVD "Software, tools and documentation"	CP9006
	Programming software CODESYS · for configuration, programming and diagnosis of ifm controller systems · English version · incl. the DVD "Software, tools and documentation"	CP9008

Scale drawings / drawing no. – CAD download: www.ifm.com

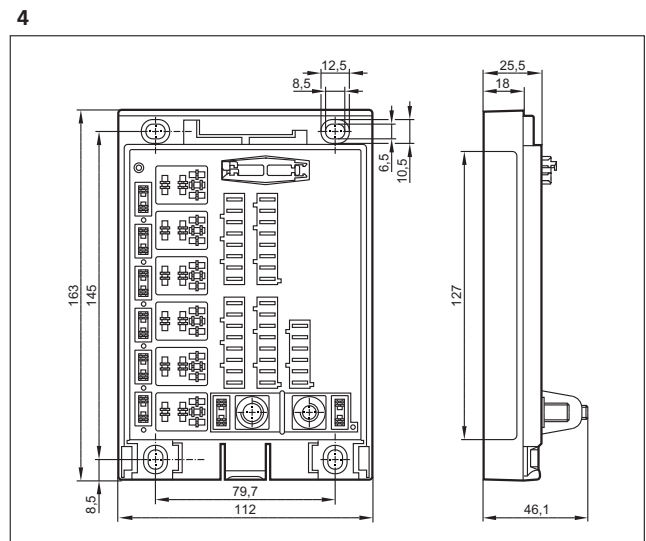
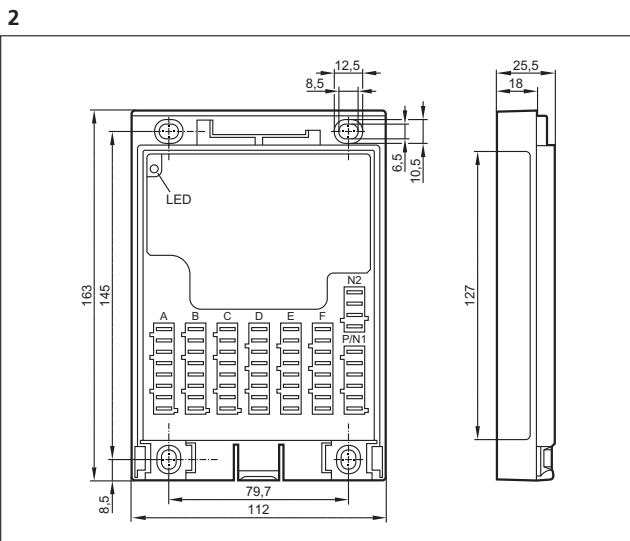
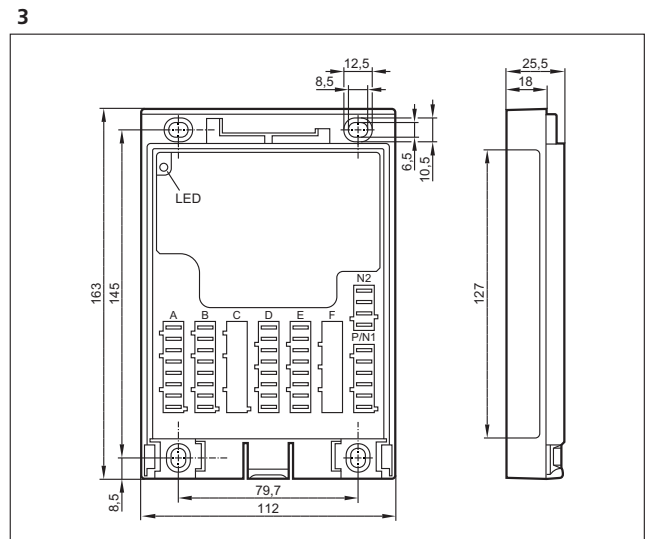
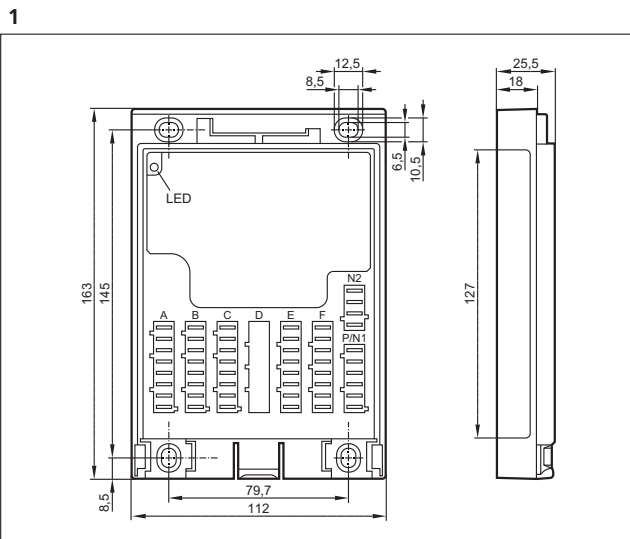

Scale drawings / drawing no. – CAD download: www.ifm.com

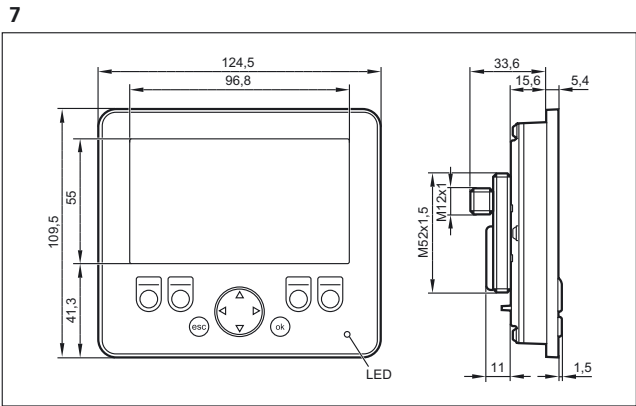
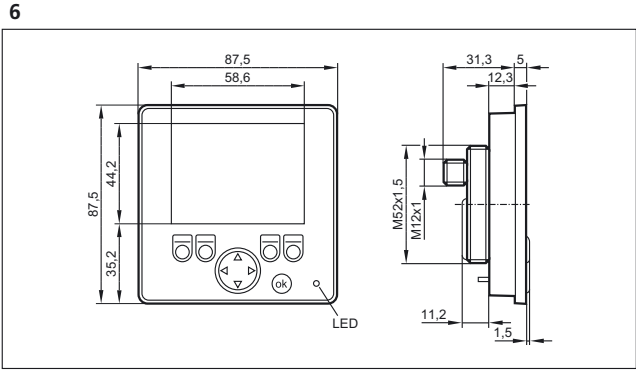
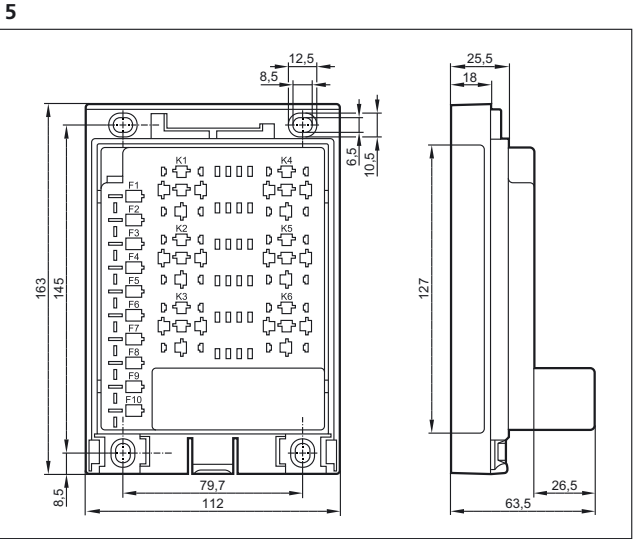



Mobile controllers

The platform of the ecomat*mobile* control system: the powerful controller family. Free programmability and the variety of configuration options enable use in a wide range of different applications.

System overview	Page
16-bit ClassicController	690
16-bit ExtendedController	691
16-bit SmartController	691
SmartController 32 bits	691
16-bit SafetyController	691
SafetyController 32 bits	692
32-bit ClassicController	692
32-bit ExtendedController	692
CabinetController for use in control cabinets	693
Accessories and software	693
Connection technology for control systems	693 - 695
Scale drawings / drawing no. – CAD download: www.ifm.com	695 - 696

16-bit ClassicController

Type	Inputs / outputs total	Inputs	Outputs	Interfaces	Draw- ing no.	Order no.
Configurable input / output functions, Programming according to IEC 61131-3						
	24	24 x Digital 8 x analogue (U/I) 8 x frequency	8 x Digital 8 x PWM-I 8 x PWM	2 x CAN 1 x RS-232	1	CR0505
	40	40 x Digital 8 x analogue (U/I) 8 x frequency	24 x Digital 8 x PWM-I 12 x PWM 2 x H bridge	2 x CAN 1 x RS-232	1	CR0020

16-bit ExtendedController

Type	Inputs / outputs total	Inputs	Outputs	Interfaces	Drawing no.	Order no.
------	------------------------	--------	---------	------------	-------------	-----------

Configurable input / output functions, Programming according to IEC 61131-3

	80	80 x Digital 16 x analogue (U/I) 16 x frequency	48 x Digital 16 x PWM-I 24 x PWM 4 x H bridge	2 x 2 x CAN 2 x RS-232	2	CR0200
---	----	---	--	---------------------------	---	--------

16-bit SmartController

Type	Inputs / outputs total	Inputs	Outputs	Interfaces	Drawing no.	Order no.
------	------------------------	--------	---------	------------	-------------	-----------



Configurable input / output functions, Programming according to IEC 61131-3

	12	8 x Digital 4 x analogue (U/I) 2 x frequency	4 x Digital 4 x PWM-I 4 x PWM	2 x CAN 1 x RS-232	3	CR2500
---	----	--	-------------------------------------	-----------------------	---	--------

SmartController 32 bits

Type	Inputs / outputs total	Inputs	Outputs	Interfaces	Drawing no.	Order no.
------	------------------------	--------	---------	------------	-------------	-----------



Configurable input / output functions, Programming according to IEC 61131-3

	32	16 x Digital 4 x analogue (U/I) 4 x frequency 2 x Resistor	16 x Digital 2 x analogue (0.2...10 V) 2 x PWM-I 12 x PWM	2 x CAN	3	CR2530
	64	32 x Digital 8 x analogue (U/I) 8 x frequency 4 x Resistor	32 x Digital 4 x analogue (0.2...10 V) 4 x PWM-I 24 x PWM	3 x CAN	4	CR2532

16-bit SafetyController

Type	Inputs / outputs total	Inputs	Outputs	Interfaces	Drawing no.	Order no.
------	------------------------	--------	---------	------------	-------------	-----------



SILCl 2 (IEC 62061), PL d (EN ISO 13849-1), Configurable input / output functions, Programming according to IEC 61131-3

	24	24 x Digital 8 x analogue (U/I) 8 x frequency	8 x Digital 8 x PWM-I 8 x PWM	2 x CAN 1 x RS-232	1	CR7506
	40	40 x Digital 8 x analogue (U/I) 8 x frequency	24 x Digital 8 x PWM-I 12 x PWM 2 x H bridge	2 x CAN 1 x RS-232	1	CR7021
	80	80 x Digital 16 x analogue (U/I) 16 x frequency	48 x Digital 16 x PWM-I 24 x PWM 4 x H bridge	2 x 2 x CAN 2 x RS-232	2	CR7201

SafetyController 32 bits

Type	Inputs / outputs total	Inputs	Outputs	Interfaces	Drawing no.	Order no.
------	------------------------	--------	---------	------------	-------------	-----------



SILCl 2 (IEC 62061), PL d (EN ISO 13849-1), Configurable input / output functions, Programming according to IEC 61131-3

	32	16 x Digital 16 x analogue (U/I) 16 x frequency	16 x Digital 16 x PWM-I 16 x PWM 2 x H bridge	4 x CAN 1 x RS-232 1 x USB	5	CR7032
	80	32 x Digital 32 x analogue (U/I) 32 x frequency	48 x Digital 32 x PWM-I 32 x PWM 4 x H bridge	4 x CAN 1 x RS-232 1 x USB	6	CR7132

32-bit ClassicController

Type	Inputs / outputs total	Inputs	Outputs	Interfaces	Drawing no.	Order no.
------	------------------------	--------	---------	------------	-------------	-----------



Configurable input / output functions, Programming according to IEC 61131-3

	32	16 x Digital 16 x analogue (U/I) 16 x frequency	16 x Digital 16 x PWM-I 16 x PWM 2 x H bridge	4 x CAN 1 x RS-232 1 x USB	1	CR0032
	32	16 x Digital 12 x analogue (U/I) 12 x frequency 4 x Resistor	16 x Digital 16 x PWM-I 16 x PWM 2 x H bridge	4 x CAN 1 x RS-232 1 x USB	5	CR0033
	64	32 x Digital 16 x analogue (U/I) 16 x frequency 6 x Resistor	32 x Digital 2 x analogue (0.2...10 V) 18 x PWM-I, 28 x PWM 2 x H bridge	5 x CAN 1 x RS-232 1 x USB	6	CR0133



32-bit ExtendedController

Type	Inputs / outputs total	Inputs	Outputs	Interfaces	Drawing no.	Order no.
------	------------------------	--------	---------	------------	-------------	-----------



Configurable input / output functions, Programming according to IEC 61131-3

	80	32 x Digital 32 x analogue (U/I) 32 x frequency	48 x Digital 32 x PWM-I 32 x PWM 4 x H bridge	2 x 2 x CAN 1 x RS-232 1 x USB	6	CR0234
	80	40 x Digital 36 x analogue (U/I) 36 x frequency 4 x Resistor	40 x Digital 32 x PWM-I 32 x PWM 4 x H bridge	2 x 2 x CAN 1 x RS-232 1 x USB	6	CR0235



CabinetController for use in control cabinets

Type	Inputs / outputs total	Inputs	Outputs	Interfaces	Drawing no.	Order no.
Configurable input / output functions, Programming according to IEC 61131-3						
	42	24 x Digital 8 x analogue (U/I) 4 x frequency	18 x Digital 4 x PWM 10 x Relay	1 x CAN 1 x RS-232	7	CR0301
	36	24 x Digital 8 x analogue (U/I) 4 x frequency	12 x Digital 4 x PWM	1 x CAN 1 x RS-232	8	CR0302
	42	24 x Digital 8 x analogue (U/I) 4 x frequency	18 x Digital 8 x PWM 6 x PNP 10 A	2 x CAN 1 x RS-232	9	CR0303

Accessories and software



Type	Description	Order no.
	Programming software CODESYS · for configuration, programming and diagnosis of ifm controller systems · German version · incl. the DVD "Software, tools and documentation"	CP9006
	Programming software CODESYS · for configuration, programming and diagnosis of ifm controller systems · English version · incl. the DVD "Software, tools and documentation"	CP9008
	Starter set ecomat R 360 Smart Controller · consisting of: · controller CR2500 · I/O simulator box incl. connection cable and connectors · plug-in power supply · DVD with programming software CODESYS · project examples and manuals	EC2074

Connection technology for control systems

Type	Description	Order no.
	Connector AMP 55-pole · wirable · with contacts (Junior Power Timer)	EC2013
	Cable with connector · AMP 55-pole · wired · Cable length 1.2 m · Cores sealed individually · Core cross-section 1 mm ²	EC2084
	Cable with connector · AMP 55-pole · wired · Cable length 2.5 m · Cores sealed individually · Core cross-section 1 mm ²	EC2097
	Cable with connector · AMP 55-pole · wired · Cable length 1.2 m · Core cross-section 1 mm ²	EC2086
	Cable with connector · AMP 55-pole · wired · Cable length 2.5 m · Core cross-section 1 mm ²	EC2046

You can find scale drawings from page 695

Type	Description	Order no.
	Cable with connector · AMP 6-pole · wired · fully wired · Cable length 1.2 m · Core cross-section 1 mm ²	EC1520
	Cable with connector · AMP 10-pole · wired · fully wired · Cable length 1.2 m · Core cross-section 1 mm ²	EC1521
	Cable with connector · AMP 14-pole · wired · fully wired · Cable length 1.2 m · Core cross-section 1 mm ²	EC1522
	Cable with connector · AMP 18-pole · wired · fully wired · Cable length 1.2 m · Core cross-section 1 mm ²	EC1523
	Cable with connector · AMP 18-pole · wired · partially wired · for input signals · Cable length 1.2 m · Core cross-section 1 mm ²	EC1524
	Cable with connector · AMP 18-pole · wired · fully wired · Cable length 2.5 m · Core cross-section 1 mm ²	EC1533
	Plug set for CabinetModule CR2012 / CR2014 · wirable · consisting of: · AMP Crimp housing 1 x 6 pins, 2 x 18 pins incl. Crimp contacts (Junior Power Timer)	EC2053
	Plug set for CabinetController CR0301 / CR0302 · wirable · consisting of: · AMP Crimp housing 1 x 6 pins, 2 x 10 pins, 3 x 18 pins incl. Crimp contacts (Junior Power Timer)	EC2075
	Plug set for CabinetModule CR201x · wirable · consisting of: · AMP Crimp housing 1 x 6 pins, 2 x 14 pins, 2 x 18 pins incl. Crimp contacts (Junior Power Timer)	EC2089
	Plug set · wirable · consisting of: · AMP Crimp housing 2 x 6 pins, 2 x 10 pins, 3 x 18 pins incl. Crimp contacts (Junior Power Timer)	EC2090
	RS-232 Programming adapter · with gender changer for pin-socket conversion	EC2076
	programming cable · cable length 2 m interface 9-pole D-SUB (female) · AMP 6-pole · Test input (AMP connector, pin 5) connected to VBB via link	EC2091
	programming cable · e.g. for ClassicController CR0032 or ExtendedController CR0232 · wired	EC2096
	Load-Dump-Module · 12 V DC	EC2015
	Load-Dump-Module · 24 V DC	EC2016

Type	Description	Order no.
	Spring terminal box · e.g. for starter set	EC2032
	Serial interface cable · 2 x 9-pole D-SUB (female) · 1:1 · e.g. for PC communication, configuration or uploads of firmware updates · Cable length 2 m · e.g. for process and dialogue monitors PDM360	EC2063

Scale drawings / drawing no. – CAD download: www.ifm.com

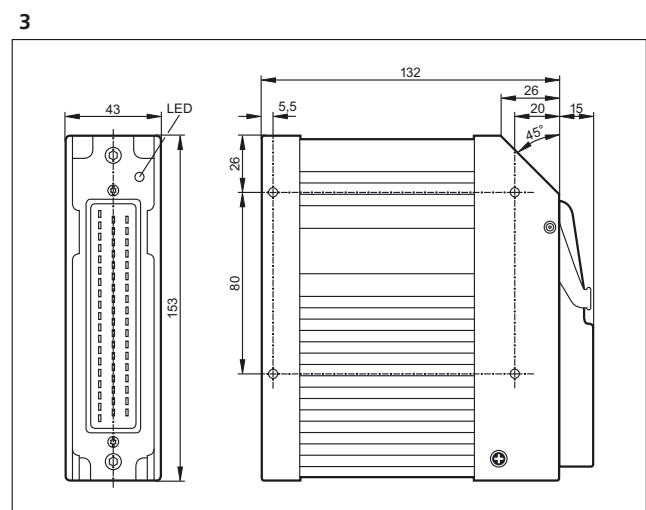
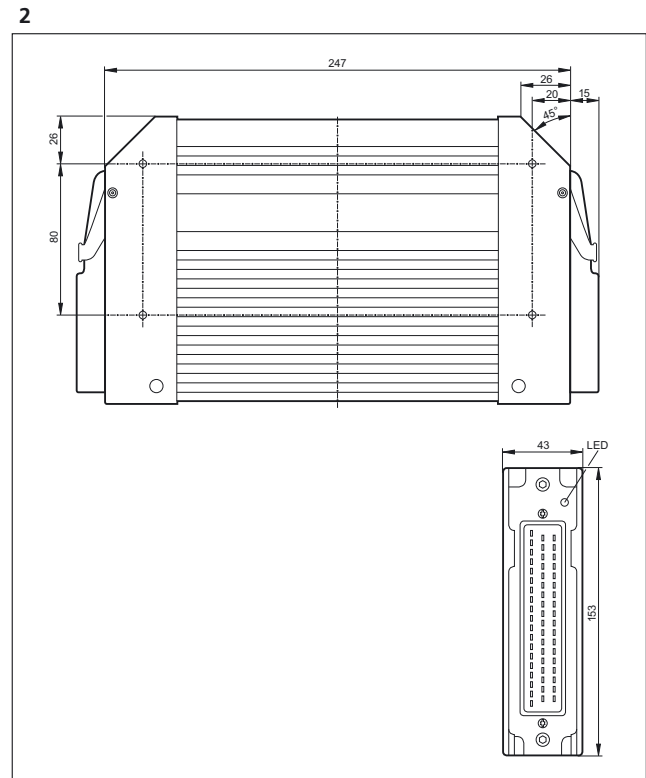
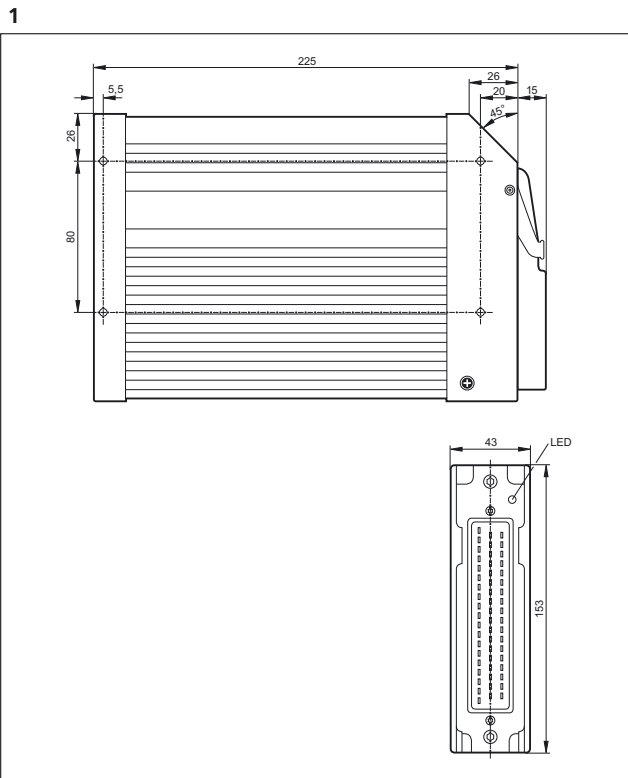

Scale drawings / drawing no. – CAD download: www.ifm.com

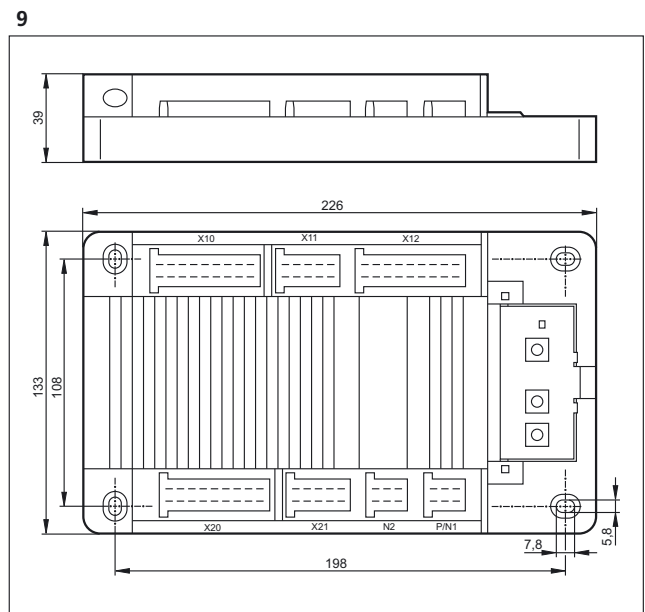
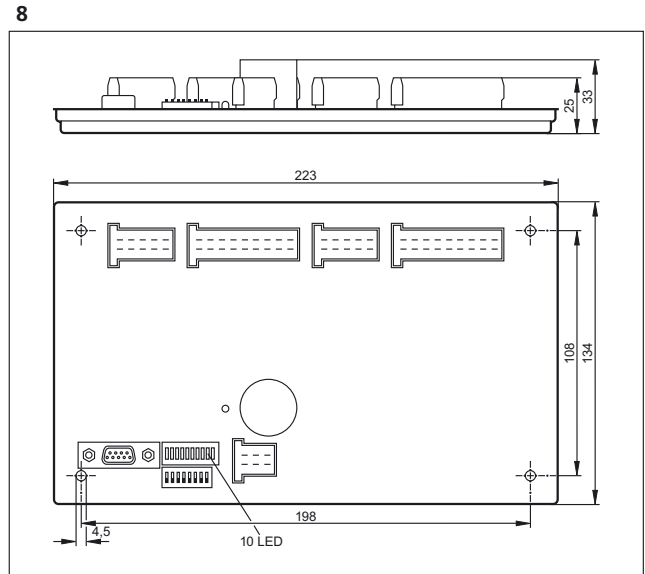
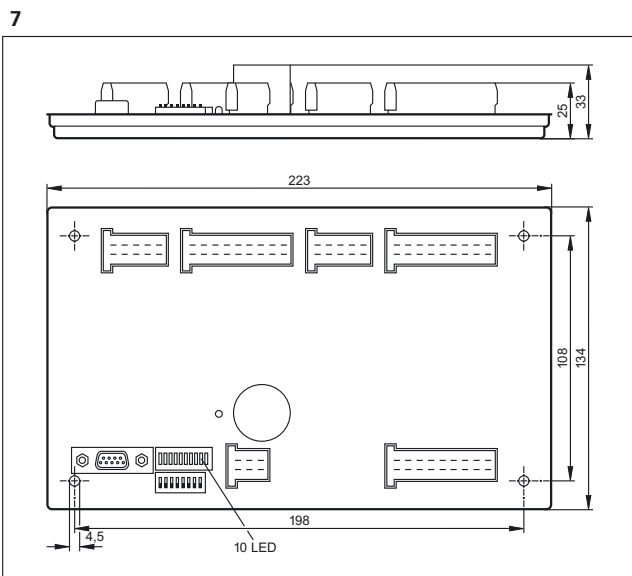
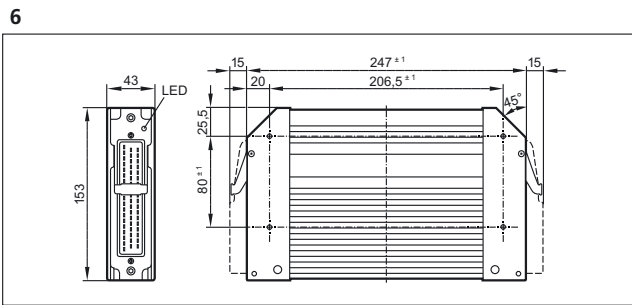
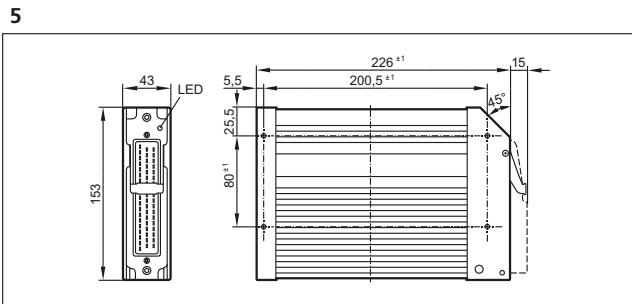
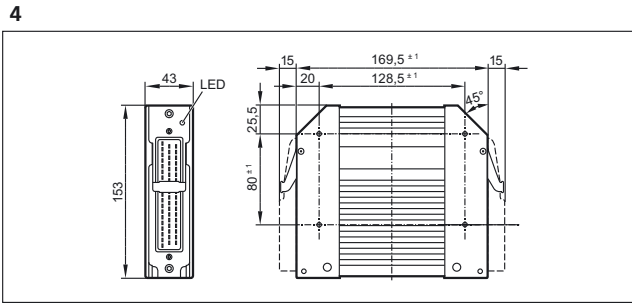



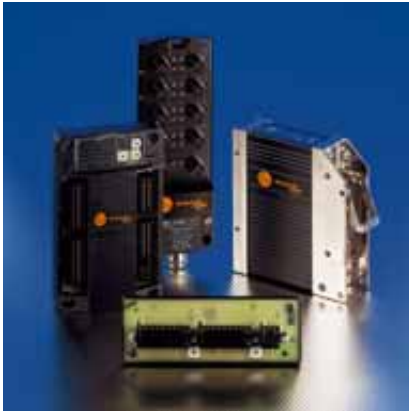

I/O modules

Decentralised I/O modules for use in CANopen bus systems. Considerably reduced wiring, they are mounted where the signals are generated.

The flexible configuration of the inputs and outputs enables universal use and reduces the costs for stockholding.

System overview	Page
CompactModules metal	698
CompactModules	698 - 699
SmartModules	699
CabinetModules	699
KeypadModules	699
Accessories for I/O modules	700 - 702
Scale drawings / drawing no. – CAD download: www.ifm.com	702 - 703

CompactModules metal

Type	Inputs / outputs total	Inputs	Outputs	Interfaces	Drawing no.	Order no.
------	------------------------	--------	---------	------------	-------------	-----------

CAN parameters adjustable via coding switch, Configurable input / output functions · M12 connector

	8	–	8 x Digital 4 x PWM-I 4 x PWM	1 x CAN	1	CR2031
	16	8 x Digital 4 x analogue (U/I)	8 x Digital 4 x PWM	1 x CAN	2	CR2032
	12	8 x Digital 4 x analogue (U/I)	4 x Digital 4 x PWM	1 x CAN	3	CR2033

CompactModules

Type	Inputs / outputs total	Inputs	Outputs	Interfaces	Drawing no.	Order no.
------	------------------------	--------	---------	------------	-------------	-----------

Configurable output functions · M12 connector

	8	–	8 x Digital 8 x PWM	1 x CAN	4	CR2011
---	---	---	------------------------	---------	---	--------

Type	Inputs / outputs total	Inputs	Outputs	Interfaces	Drawing no.	Order no.
------	------------------------	--------	---------	------------	-------------	-----------



Configurable input / output functions · M12 connector

	8	4 x Digital 4 x analogue (0...10 V)	4 x Digital 4 x PWM	1 x CAN	4	CR2013
---	---	--	------------------------	---------	---	--------

SmartModules

Type	Inputs / outputs total	Inputs	Outputs	Interfaces	Drawing no.	Order no.
------	------------------------	--------	---------	------------	-------------	-----------



Configurable input / output functions · 55-pole connec.

	12	4 x Digital	8 x Digital 8 x PWM-I 8 x PWM	1 x CAN	5	CR2512
	12	8 x Digital 4 x analogue (U/I)	4 x Digital 4 x PWM	1 x CAN	5	CR2513
	30	15 x Digital 4 x analogue (U/I)	15 x Digital 3 x PWM 4 x PNP 10 A 4 x H bridge	1 x CAN	6	CR2520

CabinetModules

Type	Inputs / outputs total	Inputs	Outputs	Interfaces	Drawing no.	Order no.
------	------------------------	--------	---------	------------	-------------	-----------

CAN parameters adjustable via coding switch, Configurable input / output functions · Connector

	16	16 x Digital 4 x analogue (0...10 V)	4 x Digital 2 x PWM	1 x CAN	7	CR2012
	16	16 x Digital 4 x analogue (0...5 V)	4 x Digital 2 x PWM	1 x CAN	7	CR2014
	32	16 x Digital 4 x analogue (U/I) 4 x frequency	16 x Digital 4 x PWM	1 x CAN	8	CR2016

KeypadModules











Type	Display	Operating elements	Inputs / outputs	Interfaces	Drawing no.	Order no.
------	---------	--------------------	------------------	------------	-------------	-----------

Programming according to IEC 61131-3 · cage clamps

	2 x LED bar graph (10-digit) 12 x LEDs	12 Pushbuttons 4 arrow keys	–	1 x CAN	9	CR1500
---	---	--------------------------------	---	---------	---	--------

Accessories for I/O modules

Type	Description	Order no.
	label tag · 20 x 9 mm · Housing materials: plastics white	E70424
	Protective cap · M12 · for M12 sockets of CompactModule Metal · Housing materials: PA black	EC2098
	Connector AMP 55-pole · wirable · with contacts (Junior Power Timer)	EC2013
	Cable with connector · AMP 55-pole · wired · Cable length 1.2 m · Cores sealed individually · Core cross-section 1 mm ²	EC2084
	Cable with connector · AMP 55-pole · wired · Cable length 2.5 m · Cores sealed individually · Core cross-section 1 mm ²	EC2097
	Cable with connector · AMP 55-pole · wired · Cable length 1.2 m · Core cross-section 1 mm ²	EC2086
	Cable with connector · AMP 55-pole · wired · Cable length 2.5 m · Core cross-section 1 mm ²	EC2046
	Plug set for CabinetModule CR2012 / CR2014 · wirable · consisting of: · AMP Crimp housing 1 x 6 pins, 2 x 18 pins incl. Crimp contacts (Junior Power Timer)	EC2053
	Plug set for CabinetModule CR201x · wirable · consisting of: · AMP Crimp housing 1 x 6 pins, 2 x 14 pins, 2 x 18 pins incl. Crimp contacts (Junior Power Timer)	EC2089
	Plug set · wirable · consisting of: · AMP Crimp housing 2 x 6 pins, 2 x 10 pins, 3 x 18 pins incl. Crimp contacts (Junior Power Timer)	EC2090
	Cable with connector · AMP 6-pole · wired · fully wired · Cable length 1.2 m · Core cross-section 1 mm ²	EC1520
	Cable with connector · AMP 10-pole · wired · fully wired · Cable length 1.2 m · Core cross-section 1 mm ²	EC1521
	Cable with connector · AMP 14-pole · wired · fully wired · Cable length 1.2 m · Core cross-section 1 mm ²	EC1522
	Cable with connector · AMP 18-pole · wired · fully wired · Cable length 1.2 m · Core cross-section 1 mm ²	EC1523

Type	Description	Order no.
	Cable with connector · AMP 18-pole · wired · partially wired · for input signals · Cable length 1.2 m · Core cross-section 1 mm ²	EC1524
	Cable with connector · AMP 18-pole · wired · fully wired · Cable length 2.5 m · Core cross-section 1 mm ²	EC1533
	Socket · straight · Free from halogen · Gold-plated contacts · M12 connector · 2 m · 5-pole · Housing materials: PUR	E11596
	Socket · straight · Free from halogen · Gold-plated contacts · M12 connector · 5 m · 5-pole · Housing materials: PUR	E11597
	Terminating resistor socket · straight · Gold-plated contacts · M12 connector · 5-pole · Housing materials: TPU	E11589
	Terminating resistor plug · straight · Gold-plated contacts · M12 connector · 5-pole · Housing materials: TPU	E11590
	Cable plug · straight · Free from halogen · Gold-plated contacts · M12 connector · 2 m · 5-pole · Housing materials: PUR	E11598
	Cable plug · straight · Free from halogen · Gold-plated contacts · M12 connector · 5 m · 5-pole · Housing materials: PUR	E11599
	Jumper · straight / straight · Free from halogen · Gold-plated contacts · 0.3 m · 5-pole · Housing materials: PUR	E11591
	Jumper · straight / straight · Free from halogen · Gold-plated contacts · 1 m · 5-pole · Housing materials: PUR	E11592
	Jumper · straight / straight · Free from halogen · Gold-plated contacts · 2 m · 5-pole · Housing materials: PUR	E11593
	Jumper · straight / straight · Free from halogen · Gold-plated contacts · 5 m · 5-pole · Housing materials: PUR	E11594
	Socket · angled · Free from silicone · Free from halogen · Gold-plated contacts · M12 connector with integrated CAN terminating resistor (120 ohm) · 5 m · 5-pole · Housing materials: housing: TPU black / sealing: Viton	EVC492
	Cable plug · angled · Free from silicone · Free from halogen · Gold-plated contacts · M12 connector · 6 m · 5-pole · Housing materials: housing: TPU black	E12215
	Wirable plug · straight · Free from silicone · Free from halogen · wirable · Gold-plated contacts · M12 connector · 5-pole · Housing materials: PA	E11506

Type	Description	Order no.
	Wireable socket · straight · Free from silicone · Free from halogen · wirable · Gold-plated contacts · M12 connector · 5-pole · Housing materials: PA	E11511
	Wireable plug · straight · Free from silicone · Free from halogen · wirable · Gold-plated contacts · M12 connector · 4-pole · Housing materials: PA	E11504
	Wireable plug · angled · Free from silicone · Free from halogen · wirable · Gold-plated contacts · M12 connector · 4-pole · Housing materials: PA	E11505
	Wireable plug · angled · Free from silicone · Free from halogen · wirable · Gold-plated contacts · M12 connector · 5-pole · Housing materials: PA	E11860
	Wireable plug · angled · Free from silicone · Free from halogen · wirable · Gold-plated contacts · M12 connector · 5-pole · Housing materials: PA	E11507
	Load-Dump-Module · 12 V DC	EC2015
	Load-Dump-Module · 24 V DC	EC2016
	Plug for Danfoss PWM valves · wirable · terminals	EC2056
	Plug for Danfoss PWM valves · M12 connector	EC2088
	Adapter cable for CAN devices with M12 connector (5 pole) · e.g. CANmem, CANremote or inclination sensors	EC2062

Scale drawings / drawing no. – CAD download: www.ifm.com

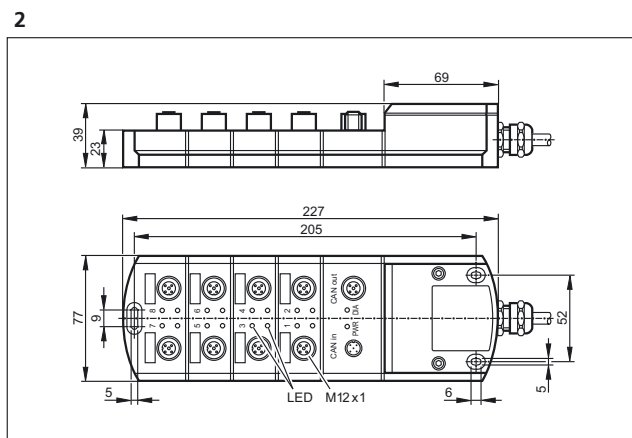
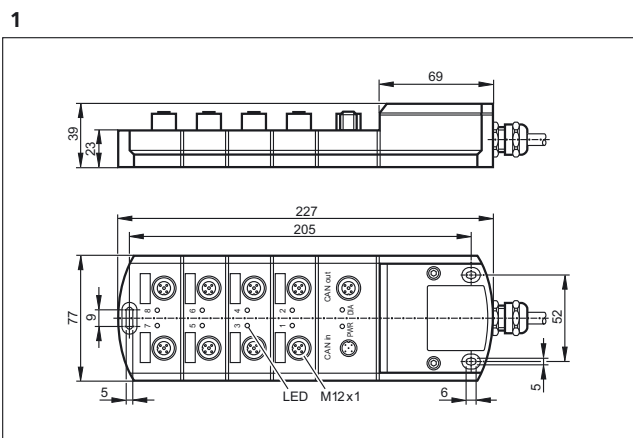

Scale drawings / drawing no. – CAD download: www.ifm.com

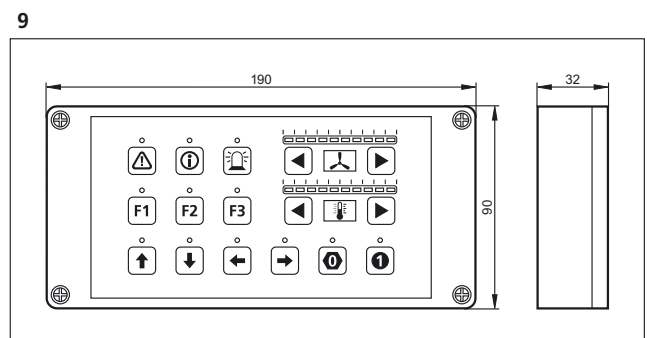
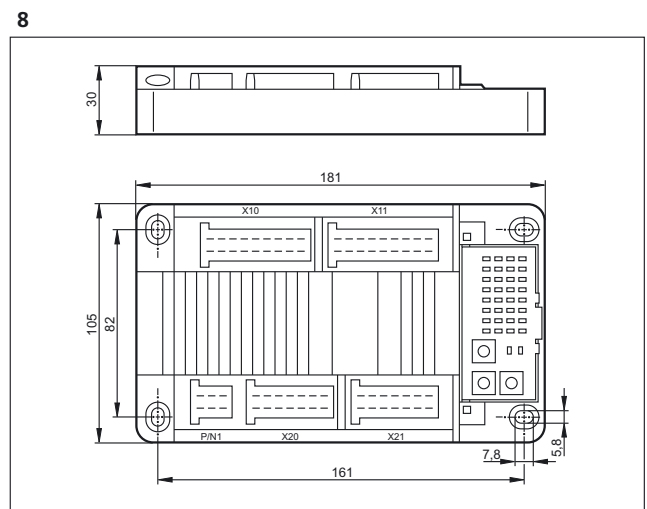
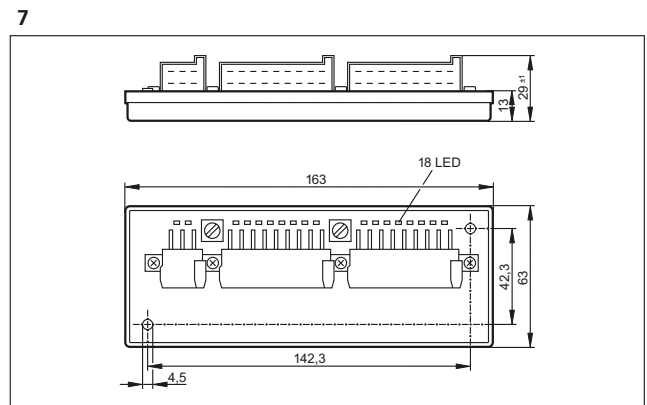
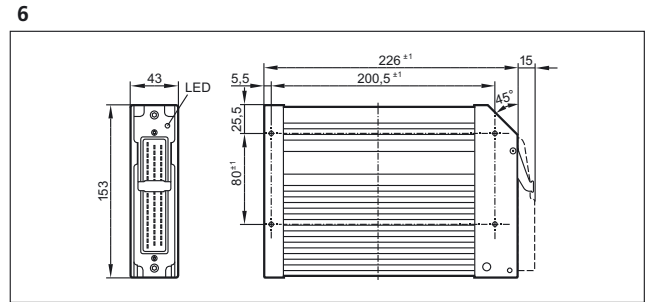
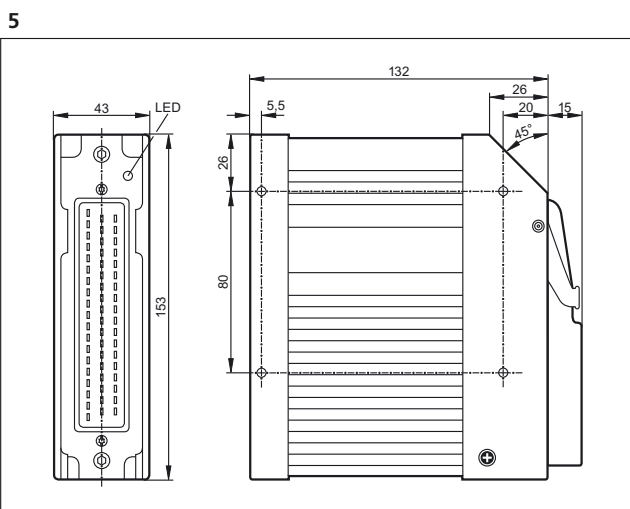
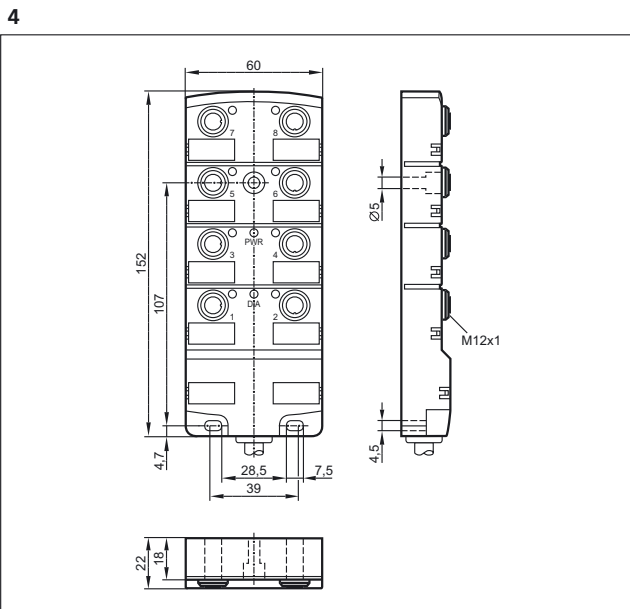
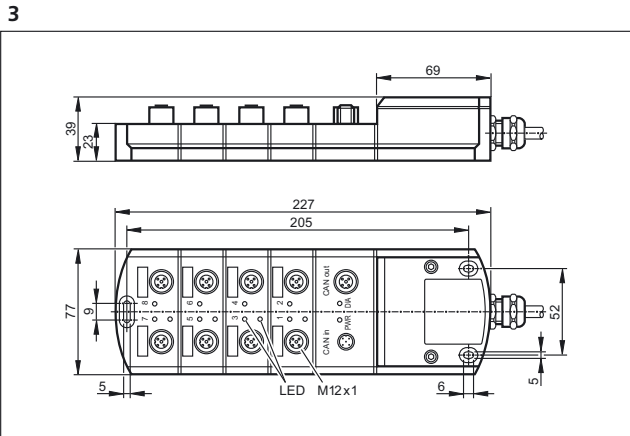



Dialogue modules / displays

Displays with graphics capabilities, free programming to IEC 61131 and various interfaces are features of the dialogue modules.

The convenient user interface for service and machine handling – the dialogue modules of the ecomat*mobile* control system.





System overview	Page
PDM360 smart with 2.5" monochrome display	704
PDM360 NG with 7" display	704 - 705
PDM360 NG with 12" Display	705
Accessories for displays	705 - 706
Connection technology for displays	707
Scale drawings / drawing no. – CAD download: www.ifm.com	707

PDM360 smart with 2.5" monochrome display

Type	Display	Operating elements	Inputs / outputs	Interfaces	Drawing no.	Order no.
12 freely programmable backlit function keys, Programming according to IEC 61131-3 · M12 connector						
	2.5" monochrome display 128 x 64 pixels	12 Pushbuttons	–	1 x CAN 1 x RS-232	1	CR1070
	2.5" monochrome display 128 x 64 pixels	12 Pushbuttons	4 x digital in 4 x digital out	1 x CAN 1 x RS-232	1	CR1071

PDM360 NG with 7" display



Type	Display	Operating elements	Inputs / outputs	Interfaces	Drawing no.	Order no.
Real-time clock, 8 freely programmable backlit function keys, Programming according to IEC 61131-3 · M12 connector						
	7" colour display 800 x 480 pixels	8 Pushbuttons	1 x digital in 1 x analogue in 1 x digital out 2 x Video (CVBS) 1 x Buzzer	4 x CAN 1 x Ethernet 2 x USB	2	CR1083
	7" colour display 800 x 480 pixels	8 Pushbuttons	1 x digital in 1 x analogue in 1 x digital out 1 x Buzzer Real-time clock	4 x CAN 1 x Ethernet 2 x USB	2	CR1087

Type	Display	Operating elements	Inputs / outputs	Interfaces	Drawing no.	Order no.
Real-time clock, 9 freely programmable backlit function keys, Programming according to IEC 61131-3 · M12 connector						
	7" colour display 800 x 480 pixels	9 Pushbuttons 1 Encoder with pushbutton	1 x digital in 1 x analogue in 1 x digital out 1 x Buzzer Real-time clock	4 x CAN 1 x Ethernet 2 x USB	3	CR1080
	7" colour display 800 x 480 pixels	9 Pushbuttons 1 Navigation key with pushbutton	1 x digital in 1 x analogue in 1 x digital out 1 x Buzzer Real-time clock	4 x CAN 1 x Ethernet 2 x USB	4	CR1081
	7" colour display 800 x 480 pixels	9 Pushbuttons 1 Navigation key with pushbutton 1 Touch screen	1 x digital in 1 x analogue in 1 x digital out 2 x Video (CVBS) 1 x Buzzer	4 x CAN 1 x Ethernet 2 x USB	4	CR1082
	7" colour display 800 x 480 pixels	9 Pushbuttons 1 Encoder with pushbutton	1 x digital in 1 x analogue in 1 x digital out 2 x Video (CVBS) 1 x Buzzer	4 x CAN 1 x Ethernet 2 x USB	3	CR1084
	7" colour display 800 x 480 pixels	9 Pushbuttons 1 Navigation key with pushbutton	1 x digital in 1 x analogue in 1 x digital out 2 x Video (CVBS) 1 x Buzzer	4 x CAN 1 x Ethernet 2 x USB	4	CR1085

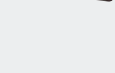
PDM360 NG with 12" Display



Type	Display	Operating elements	Inputs / outputs	Interfaces	Drawing no.	Order no.
Real-time clock, Programming according to IEC 61131-3 · M12 connector						
	12" colour display 1024 x 768 pixels	13 Pushbuttons 1 Navigation key with pushbutton	1 x digital in 1 x analogue in 1 x digital out 2 x Video (CVBS) 1 x Buzzer	4 x CAN 1 x Ethernet 2 x USB	5	CR1200
	12" colour display 1024 x 768 pixels	13 Pushbuttons 1 Navigation key with pushbutton 1 Touch screen	1 x digital in 1 x analogue in 1 x digital out 2 x Video (CVBS) 1 x Buzzer	4 x CAN 1 x Ethernet 2 x USB	5	CR1201

Accessories for displays

Type	Description	Order no.
	Snap in set · e.g. for process and dialogue monitors PDM360, PDM360 compact or PDM360 smart · for panel mounting · consisting of: · 4 plastic springs	EC1452
	Fixing set · e.g. for process and dialogue monitors PDM360, PDM360 compact or PDM360 smart · for control cabinet mounting · consisting of: · 4 mounting brackets, 4 cylinder screws	EC1453
	Mounting plate · RAM mount system · Ball size 1.5" (C) · e.g. for process and dialogue monitors PDM360 NG, PDM360, PDM360 compact or PDM360 smart · for use as a desktop unit	EC1410

Type	Description	Order no.
	Mounting arm short · 90 mm · RAM mount system · Ball size 1.5" (C) · e.g. for process and dialogue monitors PDM360 NG, PDM360, PDM360 compact or PDM360 smart · for use as a desktop unit	EC1411
	Mounting arm standard · 144 mm · RAM mount system · Ball size 1.5" (C) · e.g. for process and dialogue monitors PDM360 NG, PDM360, PDM360 compact or PDM360 smart · for use as a desktop unit	EC1412
	Mounting arm long · 231 mm · RAM mount system · Ball size 1.5" (C) · e.g. for process and dialogue monitors PDM360 NG, PDM360, PDM360 compact or PDM360 smart · for use as a desktop unit	EC1413
	RAM mount set 1 · 144 mm · RAM mount system · Ball size 1.5" (C) · e.g. for process and dialogue monitors PDM360 NG, PDM360, PDM360 compact or PDM360 smart · for use as a desktop unit	EC1414
	Seal and vibration absorber · for process and dialogue modules PDM360 smart, PDM360 compact	EC1450
	Mounting frame and vibration absorber · for process and dialogue modules PDM360 NG · panel · Housing materials: steel sheet	EC2110
	Seal and vibration absorber · for process and dialogue modules PDM360 NG · panel · Housing materials: TPE black	EC2115
	Load-Dump-Module · 12 V DC	EC2015
	Load-Dump-Module · 24 V DC	EC2016
	plug-in power supply · with interchangeable mains plugs (EU/UK/USA/AUS) · Output 24 V DC / 1000 mA	EC2059
	Mounting frame and vibration absorber · for process and dialogue modules PDM360 NG · panel · Housing materials: steel sheet	EC2110
	Seal and vibration absorber · for process and dialogue modules PDM360 NG · panel · Housing materials: TPE black	EC2115
	Installation kit · for process and dialogue modules PDM360 NG-12 · panel · Housing materials: steel sheet	EC2117

Connection technology for displays

Type	Description	Order no.
	Wireable plug · straight · shieldable · Free from silicone · Free from halogen · wireable · Gold-plated contacts · B-coded · M12 connector · Housing materials: diecast zinc nickel-plated	E12355
	Jumper · for process and dialogue modules PDM360 NG · USB socket for installation in control panel or dashboard · 1.5 m	EC2099
	Jumper · straight / straight · Ethernet · Cross-over patch cable · 2 m · Housing materials: PUR / PC	E11898

Scale drawings / drawing no. – CAD download: www.ifm.com

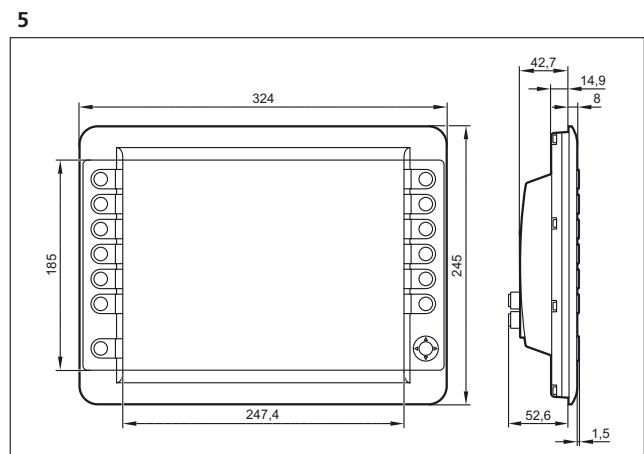
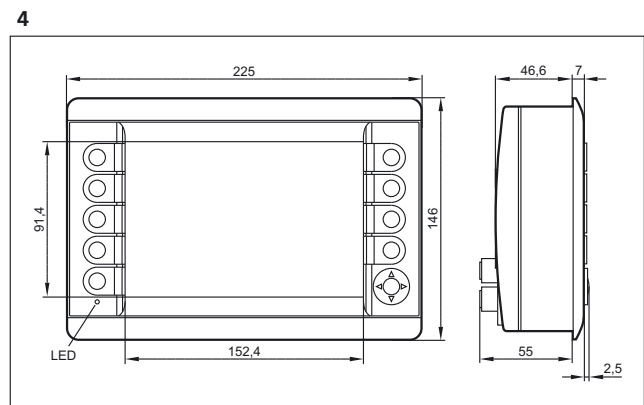
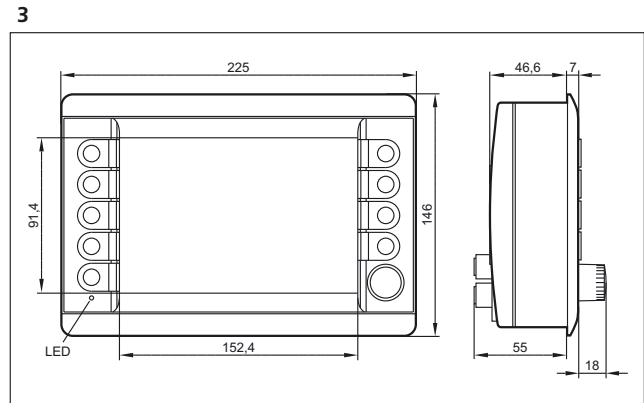
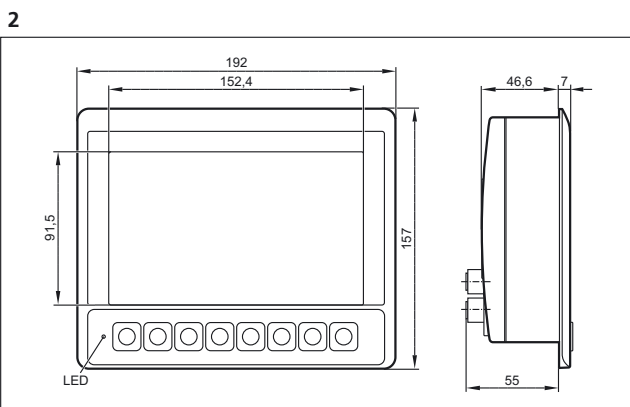
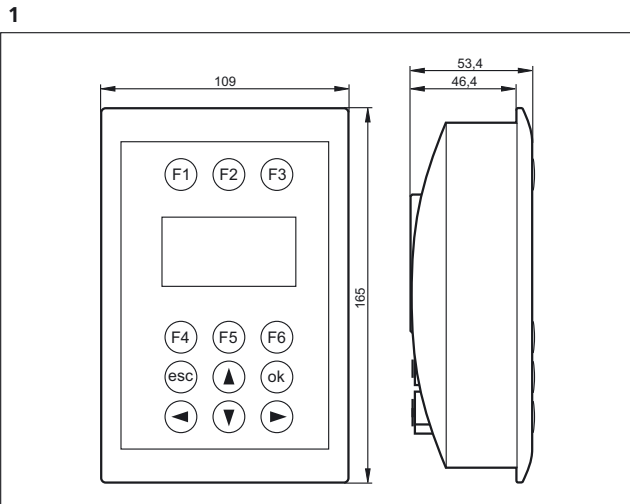



Cameras

Displays with graphics capabilities, free programming to IEC 61131 and various interfaces are features of the dialogue modules.

The convenient user interface for service and machine handling – the dialogue modules of the *ecomatmobile* control system.





System overview	Page
3D sensors for mobile machines	708
Accessories	708 - 709
Connection cables for industrial imaging	709
Camera systems for PDM360 color and PDM360 NG	710
Connection technology for displays	710
Accessories	710 - 711
Camera systems for PDM360 color and PDM360 NG	711
Connection technology for displays	711
Scale drawings / drawing no. – CAD download: www.ifm.com	712

3D sensors for mobile machines



Type	Image resolution	Angle of aperture [°]	Additional functions	Interfaces	Drawing no.	Order no.
M12 connector						
	64 x 16 pixels	70 x 23	Angle of aperture 70° x 23° (horizontal x vertical)	Video signal analogue	1	O3M150
	64 x 16 pixels	70 x 23	CAN output	Video signal analogue	1	O3M151

Accessories

Type	Description	Order no.
	IR illumination unit · Device interfaces: MCI · Angle of aperture 70° x 23° (horizontal x vertical) · IR illumination unit for the operation of O3M15x and O3M25x · Connector · Housing materials: diecast aluminium	O3M950

Type	Description	Order no.
	CANfox · CAN/RS232-USB interface · Programming and diagnosis of CAN systems · 5 V DC (via USB interface)	EC2112
	Set of programming cables · for CAN interface CANfox · Cable BasicController: DIN connector, 6-pole / standard timer contact housing, 6-pole · Cable BasicDisplay: DIN connector, 6-pole / M12 socket, 5-pole · CAN interface · Voltage supply via individual wires with end ferrules · Cable length 1 m · 1 m	EC2114
	Parameter setting software for O3M15x	E3D300
	Mounting set · O3M · U-shaped fixture, adjustable · screw mounting onto common aluminium profiles and machine panels · Housing materials: fixture: stainless steel	E3M100
	Mounting set · O3M · Clamp mounting · rod mounting Ø 14 mm · Housing materials: fixture: stainless steel / clamp: stainless steel	E3M103





Connection cables for industrial imaging

Type	Description	Order no.
	Jumper · Connector · Connection between mobile 3D camera / sensor and illumination unit · 1 m	E3M121
	Jumper · Connector · Connection between mobile 3D camera / sensor and illumination unit · 2 m	E3M122
	Jumper · Connector · Connection between mobile 3D camera / sensor and illumination unit · 3 m	E3M123
	Socket · straight · M12 connector · Gold-plated contacts · Power supply for illumination unit · 2 m · Housing materials: PUR	E3M131
	Socket · straight · M12 connector · Gold-plated contacts · Power supply for illumination unit · 5 m · Housing materials: PUR	E3M132
	Socket · straight · M12 connector · Gold-plated contacts · Power supply for illumination unit · 10 m · Housing materials: PUR	E3M133



Camera systems for PDM360 color and PDM360 NG



Type	Image resolution	Angle of aperture [°]	Additional functions	Interfaces	Drawing no.	Order no.
M16 connector						
	720 x 480	78	lens heating	Video signal analogue	2	O2M200
	720 x 480	78	Integrated mirror function lens heating	Video signal analogue	2	O2M201
	720 x 480	115	lens heating	Video signal analogue	2	O2M202
	720 x 480	115	Integrated mirror function lens heating	Video signal analogue	2	O2M203

Connection technology for displays

Type	Description	Order no.
	Adapter cable · straight / straight · M16 - M12 · Gold-plated contacts · Free from silicone · 0.6 m · Housing materials: housing: PUR / sealing: EPDM	E2M200
	Adapter cable · straight / straight · Y adapter cable M12 plug / 2 x M16 socket · Gold-plated contacts · Free from silicone · 0.95 m · Housing materials: housing: PUR / sealing: EPDM	E2M201
	Jumper · straight / straight · M16 - M16 · Gold-plated contacts · Free from silicone · 5 m · Housing materials: housing: PUR / sealing: EPDM	E2M203
	Jumper · straight / straight · M16 - M16 · Gold-plated contacts · Free from silicone · 16 m · Housing materials: housing: PUR / sealing: EPDM	E2M205
	Jumper · straight / straight · M16 - M16 · Gold-plated contacts · Free from silicone · 21 m · Housing materials: housing: PUR / sealing: EPDM	E2M206

Accessories

Type	Description	Order no.
	protective housing · O2M2 · Housing materials: housing: 1.4301	E2M212
	Mounting bracket · O2M2 · Housing materials: housing: ABS reinforced glass-fibre / PC / PA	E2M211

Type	Description	Order no.
	Vibration damper · O2M2 · Housing materials: Absorber: rubber / set screw: steel M6 x 15 mm	E2M213
	Mounting set · O2M2 · Housing materials: fixture: ABS	E2M210

Camera systems for PDM360 color and PDM360 NG

Type	Image resolution	Angle of aperture [°]	Additional functions	Interfaces	Drawing no.	Order no.
M12 connector						
	320 x 240 pixels	75	image mirroring lens heating	1 x Ethernet	3	O2M110
	320 x 240 pixels	115	image mirroring lens heating	1 x Ethernet	3	O2M113

Connection technology for displays

Type	Description	Order no.
	Ethernet switch · 5 ports · Autosensing · Autocrossing · 10/100Base-TX · Redundant voltage supply · 10...30 V DC	EC2095
	Jumper · straight / straight · Ethernet · Cross-over patch cable · 2 m · Housing materials: PUR / PC	E11898
	Jumper · straight / straight · Ethernet · Gold-plated contacts · 2 m · Housing materials: TPU	E21138
	Jumper · straight / straight · Ethernet · Gold-plated contacts · 5 m · Housing materials: TPU	E21139
	Jumper · straight / straight · Ethernet · Gold-plated contacts · 10 m · Housing materials: TPU	E21137

Scale drawings / drawing no. – CAD download: www.ifm.com

1

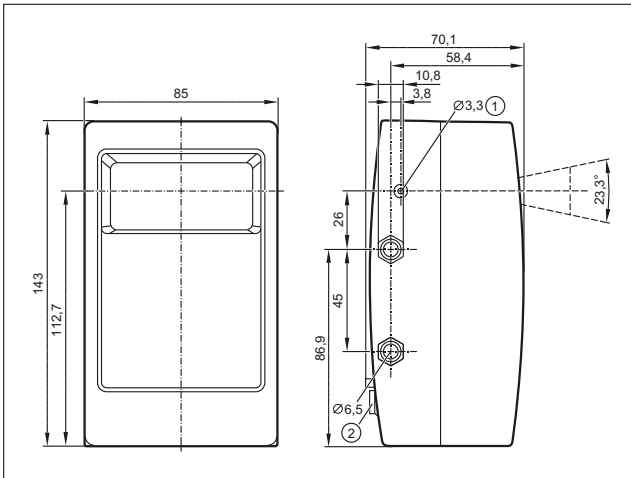

1: Reference socket, 2: Connections

2

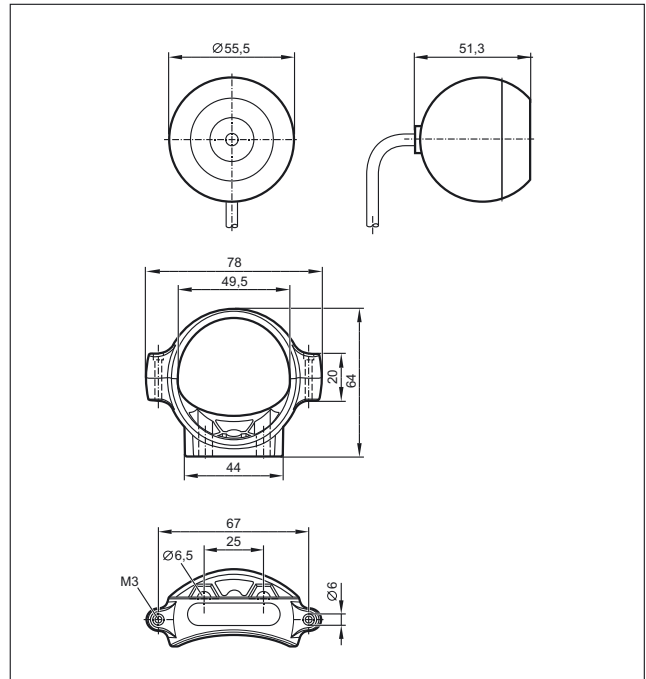

3

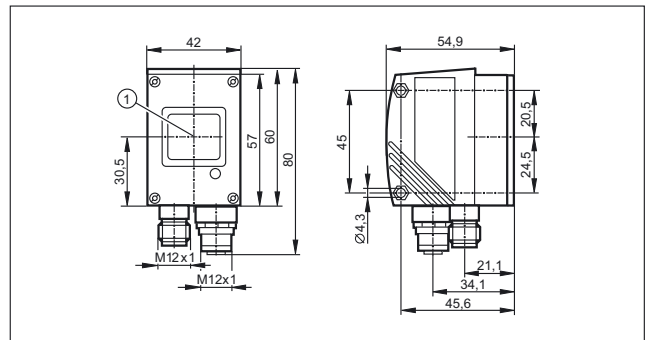





Diagnostic and service units

Detection of diagnostic data – the basis for a powerful and low-cost remote maintenance and monitoring concept.

Reduced service costs and standstill times in cases of failure are essential advantages of this modern technology.

System overview	Page
Remote maintenance	714
Data memory	714
CAN interface and diagnosis	715
Accessories for remote maintenance	715
Accessories for data memory	715
CAN cables	715 - 716
Scale drawings / drawing no. – CAD download: www.ifm.com	716

Remote maintenance

Type	Description	Draw- ing no.	Order no.
------	-------------	---------------------	--------------

M12 connector, 5-pole · FME connector, GSM antenna · SMA socket, GPS antenna

	CAN 3G/GPS radio modem · GSM/GPRS/EDGE (850/900/1800/1900 MHz) · UMTS/HSDPA (800/850/900/1700/1900/2100 MHz) · for the transfer of SMS messages and data packages · with GPS/Glonass receiver for location tracking · Shock sensor · aluminium powder-coated	1	CR3114
---	--	---	---------------



Data memory

Type	Display	Memory type	Storage functions	Interfaces	Draw- ing no.	Order no.
------	---------	-------------	-------------------	------------	---------------------	--------------



Data memory and logger for CANopen systems · M12 connector

	5 LEDs	SD memory card (max. 2 Gbytes)	linear ring on address	1 x CAN 1 x USB	2	CR3101
---	--------	-----------------------------------	------------------------------	--------------------	---	---------------

CAN interface and diagnosis

Type	Description	Draw- ing no.	Order no.
	CANfox · CAN/RS232-USB interface · Programming and diagnosis of CAN systems · 5 V DC (via USB interface)	3	EC2112
	Adapter cable · for CAN interface CANfox · CAN adapter: DIN connector, 6 poles / M12 connector, 5 poles · RS-232 adapter: DIN connector, 6 poles / Sub-D plug, 9 poles · Cable length 1 m	4	EC2113



Accessories for remote maintenance



Type	Description	Order no.
	CANremote GSM planar aerial · GSM 850/900/1800/1900 · UMTS 1920...2170 MHz · Cable length 3 m · FME socket (GSM) · flat design for mounting on all plain surfaces	EC2092
	CANremote GPS planar aerial · with integrated amplifier · Cable length 3 m · SMA aerial connector · flat design for mounting on all plain surfaces	EC2093
	GSM/GPS combined antenna · GSM 850/900/1800/1900 · UMTS 1920...2170 MHz · with integrated amplifier · Cable length 3 m · FME socket (GSM) · SMA plug (GPS) · flat design for mounting on all plain surfaces · e.g. for CANremote CR3108, CR3110 or CR3112 · thread M16 x 1.5	EC2116

Accessories for data memory

Type	Description	Order no.
	SD memory card · 2 GByte · for mobile applications	EC1021

CAN cables

Type	Description	Order no.
	Adapter cable · 9-pole D-SUB (female) · 5-pole socket; M12 · 2-pole cable for power supply with bare ends · integrated CAN terminal resistor (120 Ω) switchable	EC2050
	Adapter cable for CAN devices with M12 connector (5 pole) · e.g. CANmem, CANremote or inclination sensors	EC2062
	CAN communication cable · cable length 2 m interface 9-pole D-SUB (female) · cable ends with lugs	EC2034

Type	Description	Order no.
	Serial interface cable · 2 x 9-pole D-SUB (female) · 1:1 · e.g. for PC communication, configuration or uploads of firmware updates · Cable length 2 m · e.g. for process and dialogue monitors PDM360	EC2063
	USB connection cable · type A to type Mini B · for PC communication, configuration and uploads of firmware updates · cable length 1.8 m · e.g. for CANmem	EC2058
	Wirable socket · straight · Free from silicone · Free from halogen · wirable · Gold-plated contacts · M12 connector · 5-pole · Housing materials: PA	E11511

Scale drawings / drawing no. – CAD download: www.ifm.com

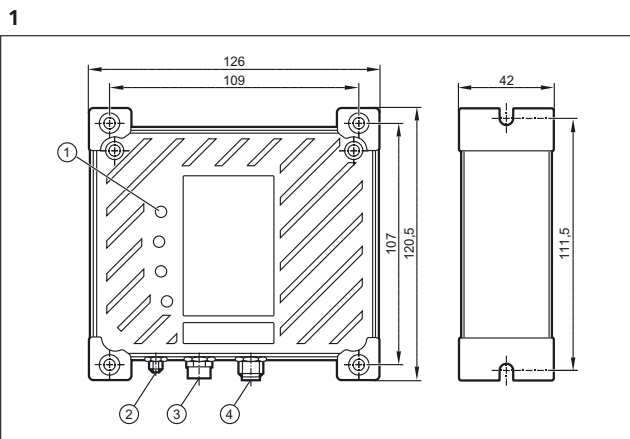

1: LEDs, 2: SMA socket, GPS antenna, 3: FME connector, GSM antenna, 4: M12 connector, 5-pole

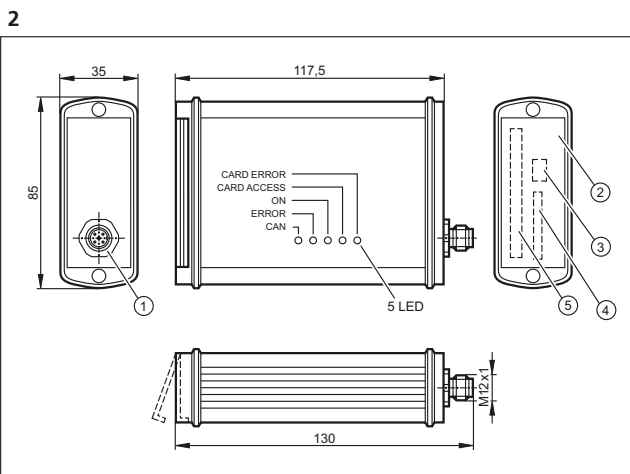

1: CANopen interface, 2: protective cover, 3: USB, type Mini-B (socket), 4: SD/MMC slot, 5: PCMCIA slot

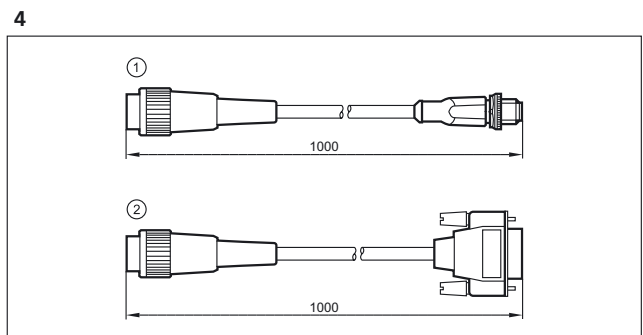
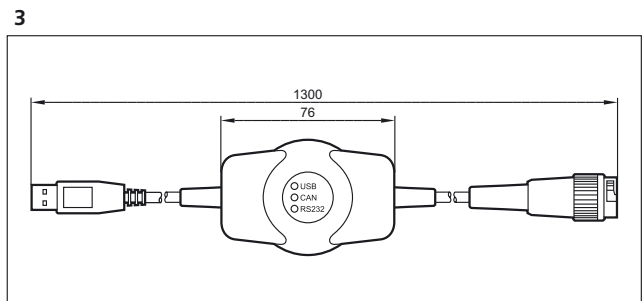

1: CAN adapter, 2: RS-232 adapter











Signal converters

The solution provider for special applications. Signal converter to adapt sensor and actuator signals to the inputs and outputs of the controller or CANopen modules.

System overview	Page
Converters and PWM modules	718
Scale drawings / drawing no. – CAD download: www.ifm.com	718 - 719

Converters and PWM modules

Type	Description	Draw- ing no.	Order no.
	PWM / analogue module · PCB · Input 24 V DC PWM signal · Output 0...5 V DC	1	CR3001
	PWM / analogue module · PCB · Input 24 V DC PWM signal · Output 0...10 V DC	1	CR3002
	PWM / analogue module · Housing · Input 24 V DC PWM signal · Output 0...5 V DC	2	CR3003
	PWM / analogue module · Housing · Input 24 V DC PWM signal · Output 0...10 V DC	2	CR3004
	DC/DC converter · Input 18...36 V DC · Output 10 V DC	3	EC2025
	Module for current measurement with ecomat R 360 controller	4	EC2049

Scale drawings / drawing no. – CAD download: www.ifm.com

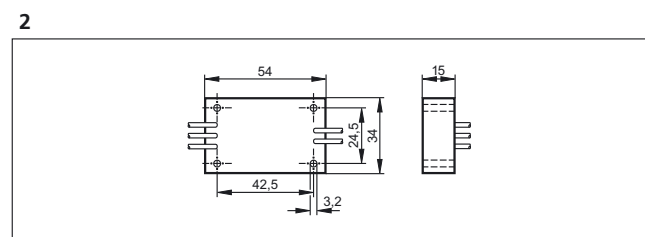
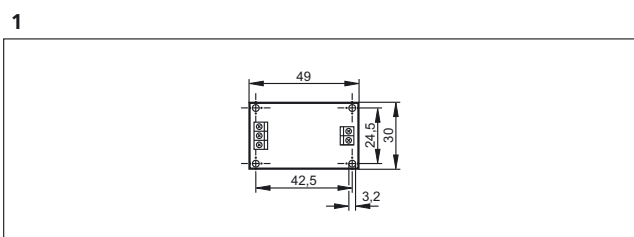

Scale drawings / drawing no. – CAD download: www.ifm.com

3

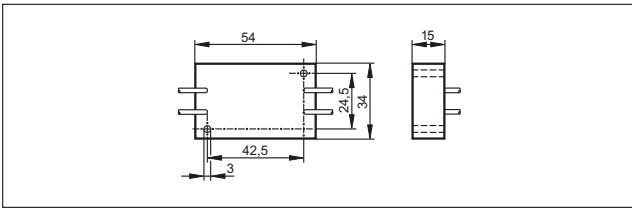

4

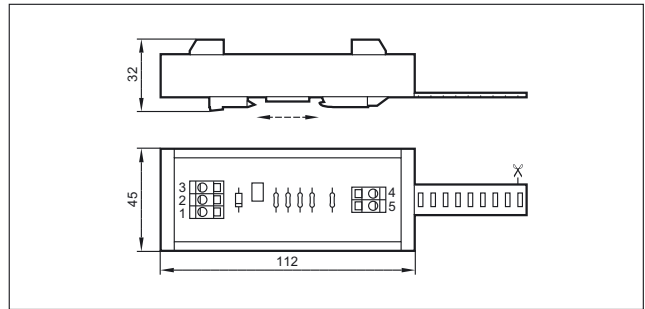



Sensors

From CAN-bus compatible or analogue inclination sensors to inductive proximity switches and pressure sensors for mobile applications.

The sensors of the ecomat*mobile* system are reliable even under the extreme conditions of use in a mobile machine.

System overview	Page
Absolute multiturn-encoders (CANopen) for mobile applications	720
RFID system 13.56 MHz	721
CAN inclination sensors	721
Inclination sensors	721
Tilt sensors	722
Inductive sensors for mobile applications	722 - 724
Full metal sensors for industrial applications	724 - 725
Sensors for mobile applications	725
Electronic pressure sensors for mobile applications	725 - 728
Accessories for sensors for mobile applications	728
Connection technology for sensors for mobile use	728 - 731
Wiring diagrams	731 - 732
Scale drawings / drawing no. – CAD download: www.ifm.com	732 - 735

Absolute multiturn-encoders (CANopen) for mobile applications

Type	Resolution	U _b	f	I _{load}	Shaft	Ambient temperature	Cable entry	Draw-ing no.	Order no.
		[V]	[kHz]	[mA]	[mm]	[°C]			

M12 connector · Output function CANopen interface · Connector group 159



24 bits	10...30	-	-	10	-40...85	axial	1	RM9000
---------	---------	---	---	----	----------	-------	---	---------------

RFID system 13.56 MHz

Type	Description	Draw- ing no.	Order no.
------	-------------	---------------------	--------------

Type M18 x 1.5 · M12 connector · CANopen interface

	Read/write head · M18 x 1.5 · M12 connector · Housing materials: housing: stainless steel / Top: PPS / connector housing: PEI	2	DTM425
---	---	---	--------

CAN inclination sensors

Type	Angular range [°]	Number of axes	Resolution / accuracy [°]	Interfaces	Wiring diagr. no.	Draw- ing no.	Order no.
------	----------------------	-------------------	---------------------------------	------------	-------------------------	---------------------	--------------

2 x M12 connector

	0...360° / ± 180°	2	0.05 / ≤ ± 0.5°	2 x CAN	–	3	JN2100
	± 45°	2	0.01 / ≤ ± 0.1°	2 x CAN	–	3	JN2101

Inclination sensors

Type	Angular range [°]	Supply voltage	Output signal	Repeatability [°]	Draw- ing no.	Order no.
------	----------------------	----------------	---------------	----------------------	---------------------	--------------

Cable

	±90°	15...30 V DC	1 x analogue (0...10 V)	0.1°	4	EC2019
	±90°	8...30 DC	1 x analogue (0.5...4.5 V)	0.1°	4	EC2045

M12 connector

	±20°	11...15 V DC	1 x analogue (4...20 mA)	0.1°	4	EC2060
	±90°	20...30 V DC	1 x analogue (4...20 mA)	0.1°	4	EC2082

Tilt sensors

Type	Angular range [°]	Supply voltage	Output signal	Repeatability [°]	Drawing no.	Order no.
------	----------------------	----------------	---------------	----------------------	-------------	-----------

Cable

	2.5...5.5°	10...30 V DC	1 x Digital	0.2°	5	EC2061
---	------------	--------------	-------------	------	---	--------

Inductive sensors for mobile applications

Type	Dimensions [mm]	Sensing range [mm]	Material	U _b [V]	Protection	f [Hz]	I _{load} [mA]	Drawing no.	Order no.
------	--------------------	-----------------------	----------	-----------------------	------------	-----------	---------------------------	-------------	-----------







Cable 3 m · Output function · DC PNP · Wiring diagram no. 1

	40 x 12 x 26	4 nf	PBT	10...36	IP 67	70	–	6	IN5281
---	--------------	------	-----	---------	-------	----	---	---	--------

Cable 3 m · Output function · DC PNP · Wiring diagram no. 2

	40 x 12 x 26	4 nf	PBT	10...36	IP 67	70	–	6	IN5282
---	--------------	------	-----	---------	-------	----	---	---	--------

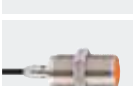
Cable 6 m · Output function · DC PNP · Wiring diagram no. 3

	M12 / L = 79	4 f	stainless steel	10...60	IP 67 / IP 69K	400	200	7	IFM209
	M12 / L = 79	7 nf	High-grade st. steel	10...60	IP 67 / IP 69K	300	200	8	IFM210
	M18 / L = 81	8 f	stainless steel	10...60	IP 67 / IP 69K	200	200	9	IGM206
	M18 / L = 81	12 nf	stainless steel	10...60	IP 67 / IP 69K	200	200	10	IGM207
	M30 / L = 81	12 f	stainless steel	10...60	IP 67 / IP 69K	100	200	11	IIM210
	M30 / L = 81	22 nf	stainless steel	10...60	IP 67 / IP 69K	100	200	12	IIM211

Cable 6 m · Output function · 3-wire DC PNP; 2-wire DC PNP/NPN · Wiring diagram no. 14







	M12 / L = 79	4 f	stainless steel	10...36	IP 67 / IP 69K	400	100	7	IFM207
---	--------------	-----	-----------------	---------	----------------	-----	-----	---	--------

Type	Dimensions [mm]	Sensing range [mm]	Material	U _b [V]	Protection	f [Hz]	I _{load} [mA]	Draw- ing no.	Order no.
------	--------------------	--------------------------	----------	-----------------------	------------	-----------	---------------------------	---------------------	--------------

Cable 6 m · Output function  · 3-wire DC PNP; 2-wire DC PNP/NPN · Wiring diagram no. 14





	M12 / L = 79	7 nf	stainless steel	10...36	IP 67 / IP 69K	300	100	8	IFM208
	M18 / L = 81	8 f	stainless steel	10...36	IP 67 / IP 69K	200	100	9	IGM202
	M18 / L = 81	12 nf	stainless steel	10...36	IP 67 / IP 69K	200	100	10	IGM203
	M30 / L = 81	12 f	stainless steel	10...36	IP 67 / IP 69K	100	100	11	IIM202
	M30 / L = 81	22 nf	stainless steel	10...36	IP 67 / IP 69K	100	100	12	IIM203

M12 connector · Output function  · DC PNP · Wiring diagram no. 4 · Connector groups 157, 158

	M12 / L = 70	4 f	High-grade st. steel	10...60	IP 67 / IP 69K	400	200	13	IFM205
	M12 / L = 70	7 nf	stainless steel	10...60	IP 67 / IP 69K	300	200	14	IFM206
	M18 / L = 70	8 f	stainless steel	10...60	IP 67 / IP 69K	200	200	15	IGM204
	M18 / L = 70	12 nf	stainless steel	10...60	IP 67 / IP 69K	200	200	16	IGM205
	M30 / L = 70	12 f	stainless steel	10...60	IP 67 / IP 69K	100	200	17	IIM208
	M30 / L = 70	22 nf	stainless steel	10...60	IP 67 / IP 69K	100	200	18	IIM209











M12 connector · Output function  · 3-wire DC PNP; 2-wire DC PNP/NPN · Wiring diagram no. 15 · Connector groups 157, 158

	M12 / L = 70	4 f	High-grade st. steel	10...36	IP 67 / IP 69K	400	100	13	IFM203
	M12 / L = 70	7 nf	High-grade st. steel	10...36	IP 67 / IP 69K	300	100	14	IFM204

Type	Dimensions [mm]	Sensing range [mm]	Material	U _b [V]	Protection	f [Hz]	I _{load} [mA]	Draw- ing no.	Order no.
M12 connector · Output function  · 3-wire DC PNP; 2-wire DC PNP/NPN · Wiring diagram no. 15 · Connector groups 157, 158									
	M18 / L = 70	8 f	stainless steel	10...36	IP 67 / IP 69K	200	100	15	IGM200
	M18 / L = 70	12 nf	stainless steel	10...36	IP 67 / IP 69K	200	100	16	IGM201
	M30 / L = 70	12 f	stainless steel	10...36	IP 67 / IP 69K	100	100	17	IIM200
	M30 / L = 70	22 nf	stainless steel	10...36	IP 67 / IP 69K	100	100	18	IIM201

f = flush / nf = non flush

Full metal sensors for industrial applications

Type	Dimensions [mm]	Sensing range [mm]	Material	U _b [V]	Protection	f [Hz]	I _{load} [mA]	Draw- ing no.	Order no.
M12 connector · Output function  · DC PNP · Wiring diagram no. 4 · Connector groups 8, 10, 11, 18, 20, 120, 124, 126, 128, 130, 157, 158									
	M12 / L = 93	1.8 f	High-grade st. steel	10...36	IP 65 / IP 68 / IP 69K	1000	200	19	MFH200
M12 connector · Output function  · DC NPN · Wiring diagram no. 5 · Connector groups 8, 10, 18, 20, 120, 124, 126, 128, 157									
	M12 / L = 93	1.8 f	High-grade st. steel	10...36	IP 65 / IP 68 / IP 69K	1000	200	19	MFH201
M12 connector · Output function  · DC PNP · Wiring diagram no. 4 · Connector groups 8, 10, 11, 18, 20, 120, 124, 126, 128, 130, 157, 158									
	M12 / L = 60	1.8 f	High-grade st. steel	10...36	IP 65 / IP 68 / IP 69K	1000	200	20	MFH202
M12 connector · Output function  · DC NPN · Wiring diagram no. 5 · Connector groups 8, 10, 18, 20, 120, 124, 126, 128, 157									
	M12 / L = 60	1.8 f	High-grade st. steel	10...36	IP 65 / IP 68 / IP 69K	1000	200	20	MFH203
M12 connector · Output function  · DC PNP · Wiring diagram no. 6 · Connector groups 8, 10, 18, 20, 120, 124, 126, 128, 157									
	M12 / L = 60	1.8 f	High-grade st. steel	10...36	IP 65 / IP 68 / IP 69K	1000	200	20	MFH204

Type	Dimensions [mm]	Sensing range [mm]	Material	U _b [V]	Protection	f [Hz]	I _{load} [mA]	Draw- ing no.	Order no.
------	--------------------	--------------------------	----------	-----------------------	------------	-----------	---------------------------	---------------------	--------------

M12 connector · Output function  · DC PNP · Wiring diagram no. 4 · Connector groups 8, 10, 11, 18, 20, 120, 124, 126, 128, 130, 157, 158

	special design	2 f	High-grade st. steel	10...36	IP 65 / IP 68 / IP 69K	1000	200	21	M9H200
---	----------------	-----	----------------------	---------	---------------------------	------	-----	----	--------

f = flush / nf = non flush

Sensors for mobile applications

Type	Dimensions [mm]	Sensing range [mm]	Material	U _b [V]	Protection	f [Hz]	I _{load} [mA]	Draw- ing no.	Order no.
------	--------------------	--------------------------	----------	-----------------------	------------	-----------	---------------------------	---------------------	--------------

M12 connector · Output function  · DC PNP · Wiring diagram no. 4 · Connector groups 8, 10, 11, 18, 20, 120, 124, 126, 128, 130, 157, 158

	M12 / L = 60	60	stainless steel	10...30	IP 67	5000	200	22	MF5004
---	--------------	----	-----------------	---------	-------	------	-----	----	--------

Cable with connector 0.15 m · Output function  · DC PNP · Wiring diagram no. 4 · Connector groups 1, 2, 3, 72, 78, 120, 122

	40 x 12 x 26	60	PBT	10...30	IP 67	–	200	23	MN5200
---	--------------	----	-----	---------	-------	---	-----	----	--------

Electronic pressure sensors for mobile applications

Type	Process connection	Display	Measuring range [bar]	P _{overload} max. [bar]	P _{bursting} min. [bar]	U _b DC [V]	Draw- ing no.	Order no.
------	-----------------------	---------	-----------------------------	-------------------------------------	-------------------------------------	-----------------------------	---------------------	--------------

AMP Superseal · Output function 0...10 V analogue · Wiring diagram no. 7

	G ¼ A	–	0...400	1000	1700	16...32	24	PU5600
	G ¼ A	–	0...250	625	1200	16...32	24	PU5601
	G ¼ A	–	0...100	250	1000	16...32	24	PU5602
	G ¼ A	–	0...25	65	600	16...32	24	PU5603
	G ¼ A	–	0...10	25	300	16...32	24	PU5604
	G ¼ A	–	0...600	1500	2500	16...32	24	PU5660

Type	Process connection	Display	Measuring range [bar]	P _{overload} max. [bar]	P _{bursting} min. [bar]	U _b DC [V]	Draw- ing no.	Order no.
------	--------------------	---------	--------------------------	-------------------------------------	-------------------------------------	-----------------------------	---------------------	--------------

DEUTSCH connector DT04-3P · Output function 0...10 V analogue · Wiring diagram no. 8

	G ¼ A	–	0...400	1000	1700	16...32	25	PU5700
	G ¼ A	–	0...250	625	1200	16...32	25	PU5701
	G ¼ A	–	0...100	250	1000	16...32	25	PU5702
	G ¼ A	–	0...25	65	600	16...32	25	PU5703
	G ¼ A	–	0...10	25	300	16...32	25	PU5704
	G ¼ A	–	0...600	1500	2500	16...32	25	PU5760

AMP Superseal · Output function 4...20 mA analogue · Wiring diagram no. 9

	G ¼ A	–	0...400	1000	1700	8...32	24	PT5600
	G ¼ A	–	0...250	625	1200	8...32	24	PT5601
	G ¼ A	–	0...100	250	1000	8...32	24	PT5602
	G ¼ A	–	0...25	65	600	8...32	24	PT5603
	G ¼ A	–	0...10	25	300	8...32	24	PT5604
	G ¼ A	–	0...600	1500	2500	8...32	24	PT5660

DEUTSCH connector DT04-3P · Output function 4...20 mA analogue · Wiring diagram no. 10

	G ¼ A	–	0...400	1000	1700	8...32	25	PT5700
	G ¼ A	–	0...250	625	1200	8...32	25	PT5701
	G ¼ A	–	0...100	250	1000	8...32	25	PT5702

Type	Process connection	Display	Measuring range [bar]	P _{overload} max. [bar]	P _{bursting} min. [bar]	U _b DC [V]	Draw- ing no.	Order no.
------	--------------------	---------	--------------------------	-------------------------------------	-------------------------------------	-----------------------------	---------------------	--------------

DEUTSCH connector DT04-3P · Output function 4...20 mA analogue · Wiring diagram no. 10

	G ¼ A	–	0...25	65	600	8...32	25	PT5703
	G ¼ A	–	0...10	25	300	8...32	25	PT5704
	G ¼ A	–	0...600	1500	2500	8...32	25	PT5760

M12 connector · Output function 2 x normally open / closed programmable or 1 x normally open / closed programmable + 1 x normally closed (diagnostic function) · Wiring diagram no. 11 · Connector groups 157, 158

	G ¼ A / M5 I	Operation	0...400	600	1000	9.6...36	26	PP000E
	G ¼ A / M5 I	Operation	0...250	400	850	9.6...36	26	PP001E
	G ¼ A / M5 I	Operation	0...100	300	650	9.6...36	27	PP002E
	G ¼ A / M5 I	Operation	0...25	150	350	9.6...36	28	PP003E
	G ¼ A / M5 I	Operation	-1...10	75	150	9.6...36	28	PP004E

M12 connector · Output function 4...20 mA analogue · Wiring diagram no. 12 · Connector group 157

	G ¼ A	–	0...400	600	1600	8.5...36	29	PT3550
	G ¼ A	–	0...250	400	1000	8.5...36	29	PT3551
	G ¼ A	–	0...100	200	1000	8.5...36	29	PT3552
	G ¼ A	–	0...25	60	600	8.5...36	29	PT3553
	G ¼ A	–	0...10	25	300	8.5...36	29	PT3554
	G ¼ A	–	0...600	9600	2400	8.5...36	29	PT3560





M12 connector · Output function 0...10 V analogue · Wiring diagram no. 13 · Connector group 157

	G ¼ A	–	0...400	600	1600	16...36	29	PT9550
---	-------	---	---------	-----	------	---------	----	--------

You can find wiring diagrams and scale drawings from page 731

Type	Process connection	Display	Measuring range [bar]	P _{overload} max. [bar]	P _{bursting} min. [bar]	U _b DC [V]	Draw- ing no.	Order no.
M12 connector · Output function 0...10 V analogue · Wiring diagram no. 13 · Connector group 157								
	G ¼ A	–	0...250	400	1000	16...36	29	PT9551
	G ¼ A	–	0...100	200	1000	16...36	29	PT9552
	G ¼ A	–	0...25	60	600	16...36	29	PT9553
	G ¼ A	–	0...10	25	300	16...36	29	PT9554

Accessories for sensors for mobile applications







Type	Description	Order no.
	Programming/ display unit · for EPS and IO-Link sensors · Connector · Housing materials: stainless steel 316L / 1.4404 / PC copolymer / PBT / FPM	PP2001
	Mounting clamp · Ø 12 mm · with end stop · for type M12 · Housing materials: PC	E11047
	Mounting clamp · Ø 18 mm · with end stop · for type M18 · Housing materials: PC	E11048
	Mounting clamp · Ø 30 mm · with end stop · for type M30 · Housing materials: PC	E11049
	Angle bracket · for type M12 · Housing materials: stainless steel	E10735
	Angle bracket · for type M18 · Housing materials: stainless steel	E10736
	Angle bracket · for type M30 · Housing materials: stainless steel	E10737

Connection technology for sensors for mobile use

Type	Description	Order no.
	Jumper · straight / straight · Free from silicone · Free from halogen · Gold-plated contacts · 0.3 m · Housing materials: housing: TPU orange / sealing: FKM	EVC010

Type	Description	Order no.
	Jumper · straight / straight · Free from silicone · Free from halogen · Gold-plated contacts · 1 m · Housing materials: housing: TPU orange / sealing: FKM	EVC012
	Socket · angled · Free from silicone · Free from halogen · Gold-plated contacts · M12 connector · 2 m · Housing materials: housing: TPU orange / sealing: FKM	EVC004
	Socket · angled · Free from silicone · Free from halogen · Gold-plated contacts · M12 connector · 5 m · Housing materials: housing: TPU orange / sealing: FKM	EVC005
	Socket · angled · Free from silicone · Free from halogen · Gold-plated contacts · M12 connector · 10 m · Housing materials: housing: TPU orange / sealing: FKM	EVC006
	Socket · straight · Free from silicone · Free from halogen · Gold-plated contacts · M12 connector · 2 m · Housing materials: housing: TPU orange / sealing: FKM	EVC001
	Socket · straight · Free from silicone · Free from halogen · Gold-plated contacts · M12 connector · 5 m · Housing materials: housing: TPU orange / sealing: FKM	EVC002
	Socket · straight · Free from silicone · Free from halogen · Gold-plated contacts · M12 connector · 10 m · Housing materials: housing: TPU orange / sealing: FKM	EVC003
	Socket · straight · Free from silicone · Free from halogen · Gold-plated contacts · M12 connector · 2 m · Housing materials: housing: TPU orange / sealing: FKM	EVC526
	Socket · straight · Free from silicone · Free from halogen · Gold-plated contacts · M12 connector · 5 m · Housing materials: housing: TPU orange / sealing: FKM	EVC527
	Socket · straight · Free from silicone · Free from halogen · Gold-plated contacts · M12 connector · 10 m · Housing materials: housing: TPU orange / sealing: FKM	EVC528
	Socket · angled · Free from silicone · Free from halogen · Gold-plated contacts · M12 connector · 2 m · Housing materials: housing: TPU orange / sealing: FKM	EVC529
	Socket · angled · Free from silicone · Free from halogen · Gold-plated contacts · M12 connector · 5 m · Housing materials: housing: TPU orange / sealing: FKM	EVC530
	Socket · angled · Free from silicone · Free from halogen · Gold-plated contacts · M12 connector · 10 m · Housing materials: housing: TPU orange / sealing: FKM	EVC531
	Socket · straight · Free from silicone · Free from halogen · Gold-plated contacts · M12 connector · 2 m · Housing materials: housing: TPU orange / sealing: FKM	EVC532
	Socket · straight · Free from silicone · Free from halogen · Gold-plated contacts · M12 connector · 5 m · Housing materials: housing: TPU orange / sealing: FKM	EVC533
	Socket · straight · Free from silicone · Free from halogen · Gold-plated contacts · M12 connector · 10 m · Housing materials: housing: TPU orange / sealing: FKM	EVC534

Type	Description	Order no.
	Socket · angled · Free from silicone · Free from halogen · Gold-plated contacts · M12 connector · 2 m · Housing materials: housing: TPU orange / sealing: FKM	EVC535
	Socket · angled · Free from silicone · Free from halogen · Gold-plated contacts · M12 connector · 5 m · Housing materials: housing: TPU orange / sealing: FKM	EVC536
	Socket · angled · Free from silicone · Free from halogen · Gold-plated contacts · M12 connector · 10 m · Housing materials: housing: TPU orange / sealing: FKM	EVC537
	Socket · straight · Free from silicone · Free from halogen · Gold-plated contacts · M12 connector · 2 m · Housing materials: housing: TPU orange / sealing: FKM	EVC538
	Socket · straight · Free from silicone · Free from halogen · Gold-plated contacts · M12 connector · 5 m · Housing materials: housing: TPU orange / sealing: FKM	EVC539
	Socket · straight · Free from silicone · Free from halogen · Gold-plated contacts · M12 connector · 10 m · Housing materials: housing: TPU orange / sealing: FKM	EVC540
	Socket · angled · Free from silicone · Free from halogen · Gold-plated contacts · M12 connector · 2 m · Housing materials: housing: TPU orange / sealing: FKM	EVC541
	Socket · angled · Free from silicone · Free from halogen · Gold-plated contacts · M12 connector · 5 m · Housing materials: housing: TPU orange / sealing: FKM	EVC542
	Socket · angled · Free from silicone · Free from halogen · Gold-plated contacts · M12 connector · 10 m · Housing materials: housing: TPU orange / sealing: FKM	EVC543
	Socket · straight · Free from silicone · Free from halogen · Gold-plated contacts · M12 connector · 2 m · Housing materials: housing: TPU orange / sealing: FKM	EVC544
	Socket · straight · Free from silicone · Free from halogen · Gold-plated contacts · M12 connector · 5 m · Housing materials: housing: TPU orange / sealing: FKM	EVC545
	Socket · straight · Free from silicone · Free from halogen · Gold-plated contacts · M12 connector · 10 m · Housing materials: housing: TPU orange / sealing: FKM	EVC546
	Socket · angled · Free from silicone · Free from halogen · Gold-plated contacts · M12 connector · 2 m · Housing materials: housing: TPU orange / sealing: FKM	EVC547
	Socket · angled · Free from silicone · Free from halogen · Gold-plated contacts · M12 connector · 5 m · Housing materials: housing: TPU orange / sealing: FKM	EVC548
	Socket · angled · Free from silicone · Free from halogen · Gold-plated contacts · M12 connector · 10 m · Housing materials: housing: TPU orange / sealing: FKM	EVC549
	Socket · straight · Free from halogen · Gold-plated contacts · M12 connector · 2 m · Housing materials: PUR	E11596

Type	Description	Order no.
	Socket · straight · Free from halogen · Gold-plated contacts · M12 connector · 5 m · Housing materials: PUR	E11597
	Terminating resistor socket · straight · Gold-plated contacts · M12 connector · Housing materials: TPU	E11589
	Terminating resistor plug · straight · Gold-plated contacts · M12 connector · Housing materials: TPU	E11590
	Cable plug · straight · Free from halogen · Gold-plated contacts · M12 connector · 2 m · Housing materials: PUR	E11598
	Cable plug · straight · Free from halogen · Gold-plated contacts · M12 connector · 5 m · Housing materials: PUR	E11599
	Jumper · straight / straight · Free from halogen · Gold-plated contacts · 0.3 m · Housing materials: PUR	E11591
	Jumper · straight / straight · Free from halogen · Gold-plated contacts · 1 m · Housing materials: PUR	E11592
	Jumper · straight / straight · Free from halogen · Gold-plated contacts · 2 m · Housing materials: PUR	E11593
	Jumper · straight / straight · Free from halogen · Gold-plated contacts · 5 m · Housing materials: PUR	E11594
	Socket · angled · Free from silicone · Free from halogen · Gold-plated contacts · M12 connector with integrated CAN terminating resistor (120 ohm) · 5 m · Housing materials: housing: TPU black / sealing: FKM	EVC492
	Cable plug · angled · Free from silicone · Free from halogen · Gold-plated contacts · M12 connector · 6 m · Housing materials: housing: TPU black	E12215

Wiring diagrams

Core colours

- BN brown
- BU blue
- BK black

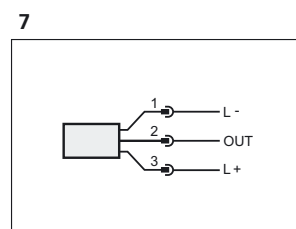
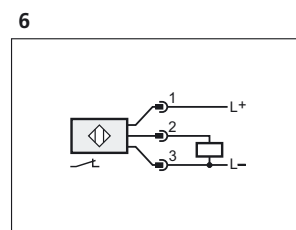
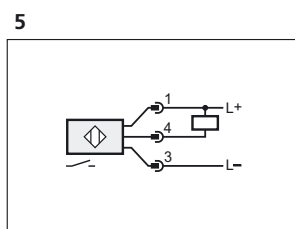
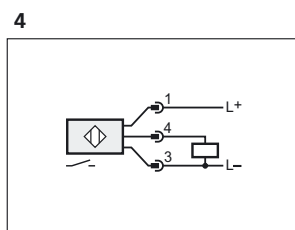
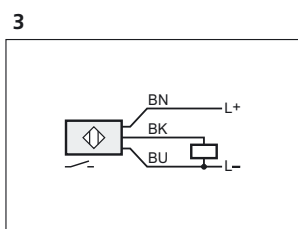
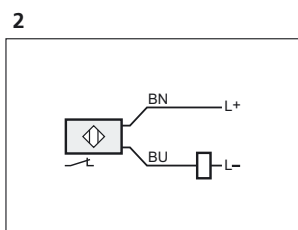
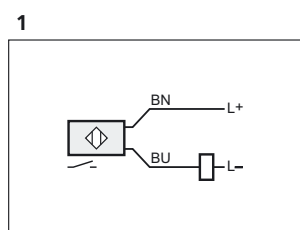

Wiring diagrams

8

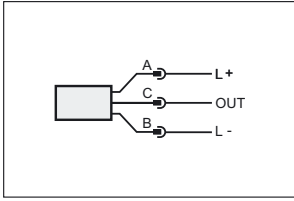

10

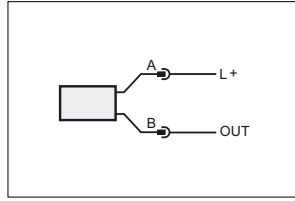

12

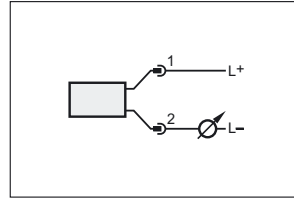

9

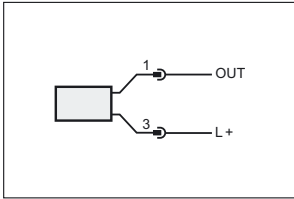

11

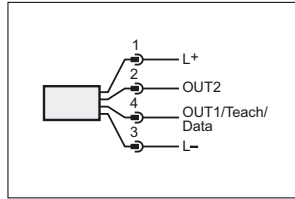

13

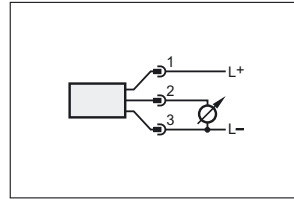

14

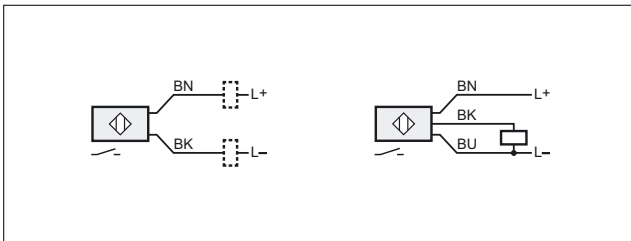

15

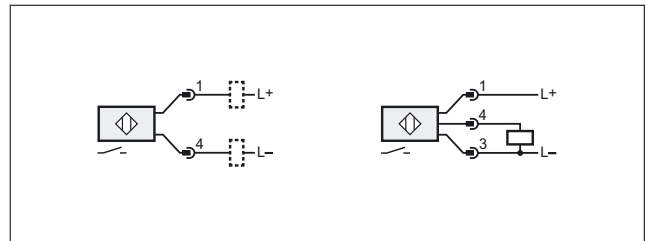

Scale drawings / drawing no. – CAD download: www.ifm.com

1

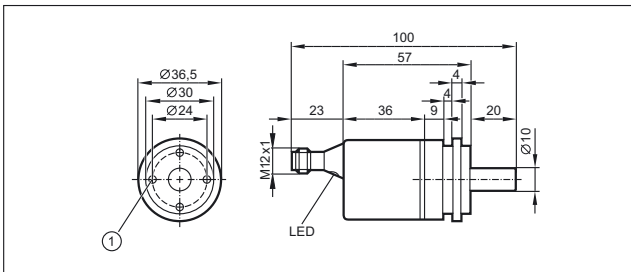

3

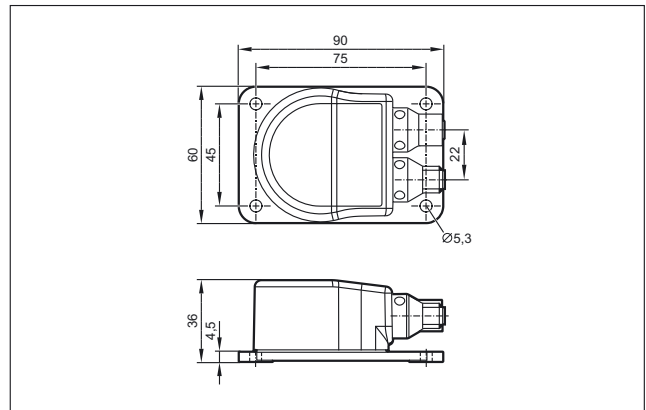

2

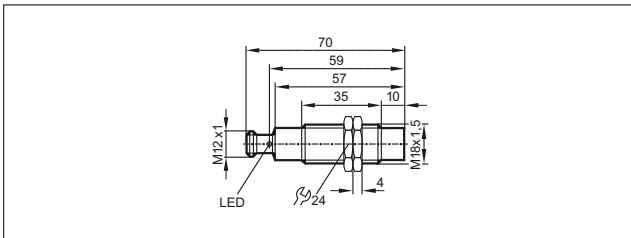

4

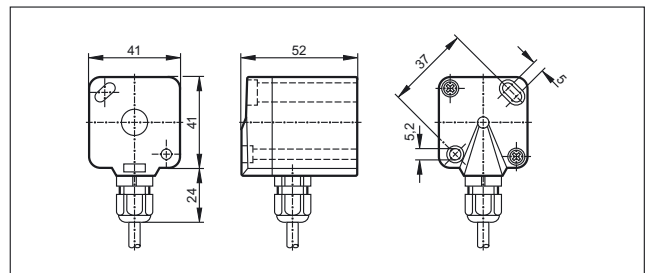

5

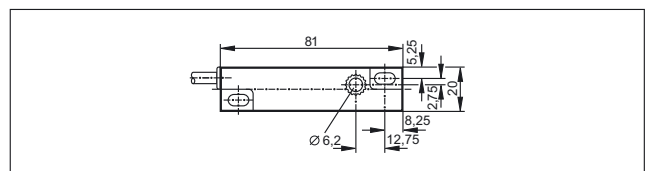

Scale drawings / drawing no. – CAD download: www.ifm.com

6

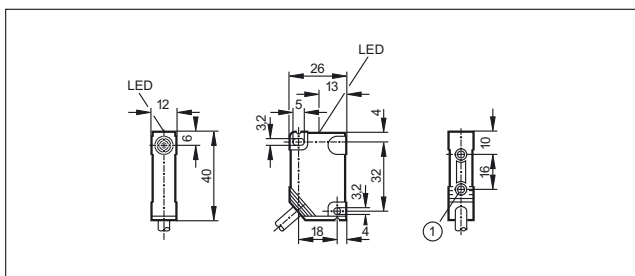

1: threaded insert M3, depth 5.8 mm, max. tightening torque 1.2 Nm (screw fixing class 8.8) when brass insert in contact with counterpart.

7

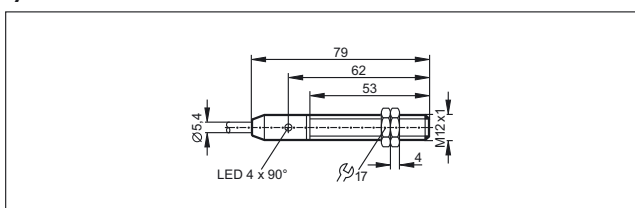

8

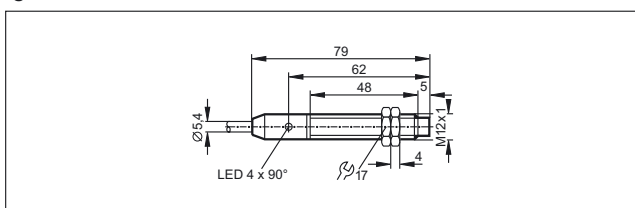

9

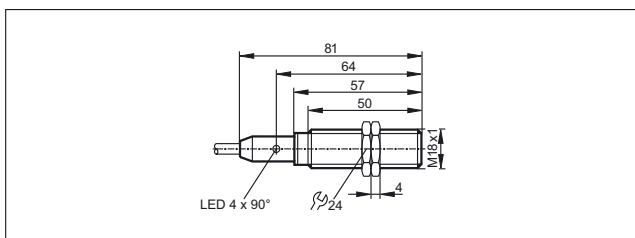

10

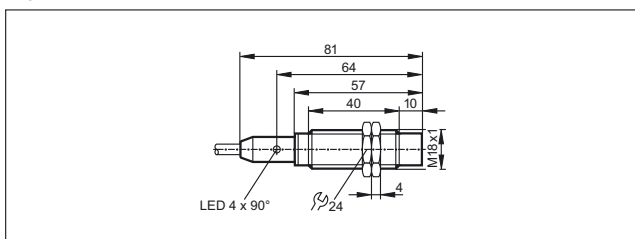

11

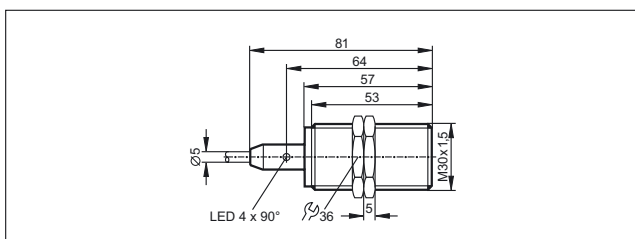

12

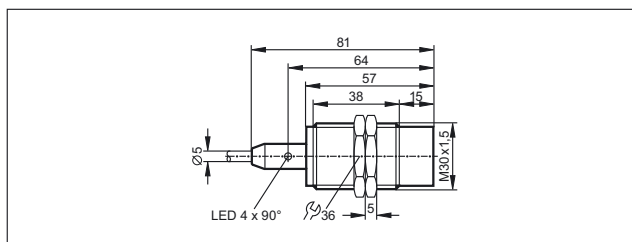

13

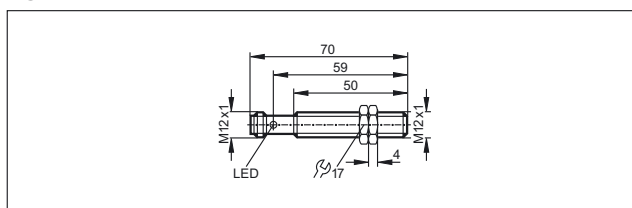

14

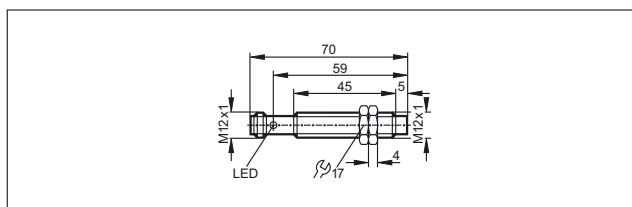

15

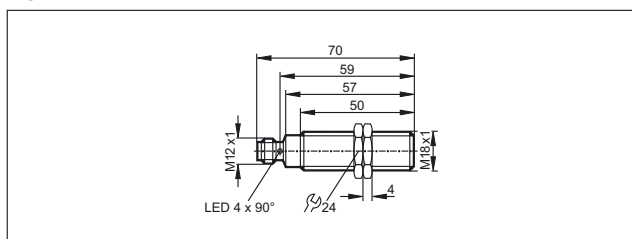

16

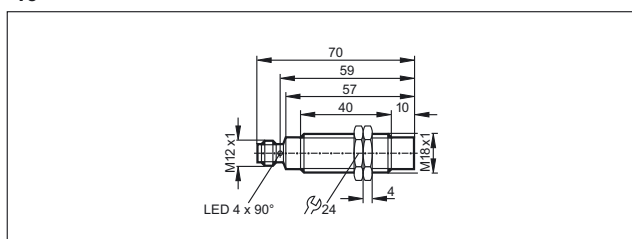

17

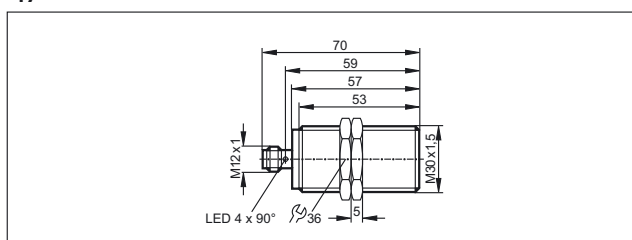

Scale drawings / drawing no. – CAD download: www.ifm.com

18

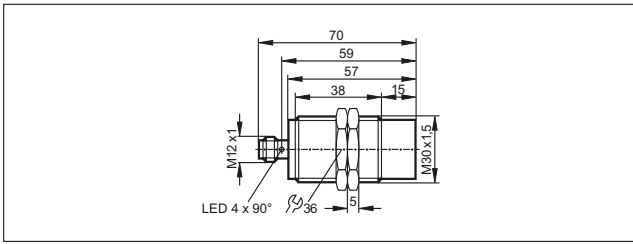

19

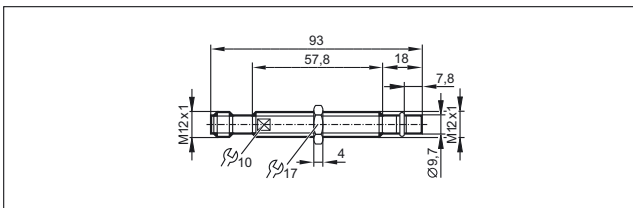

20

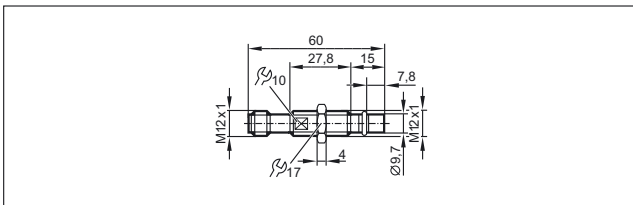

21

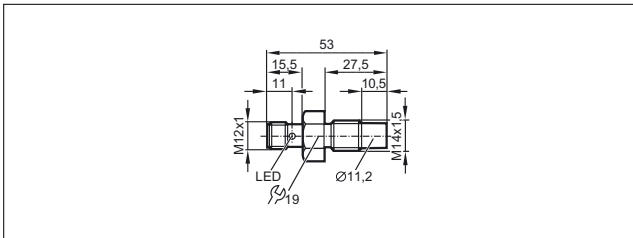

22

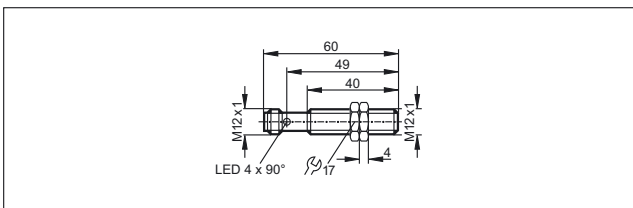

23

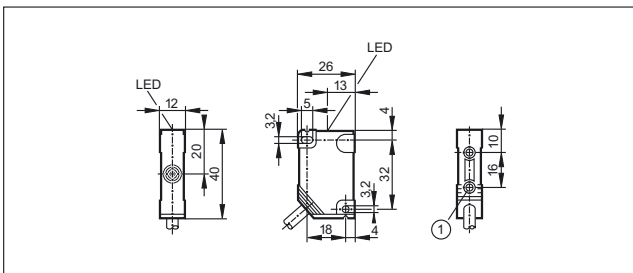

1: threaded insert M3, depth 5.8 mm, max. tightening torque 1.2 Nm (screw fixing class 8.8) when brass insert in contact with counterpart.

24

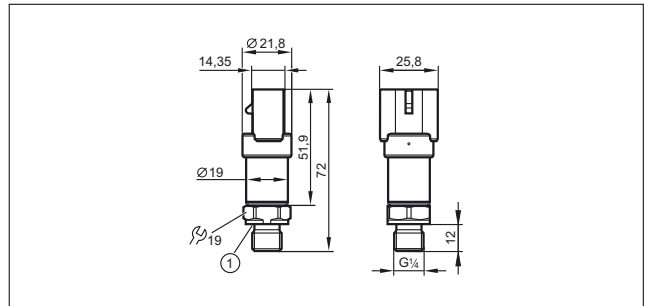

1: sealing FKM / DIN 3869

25

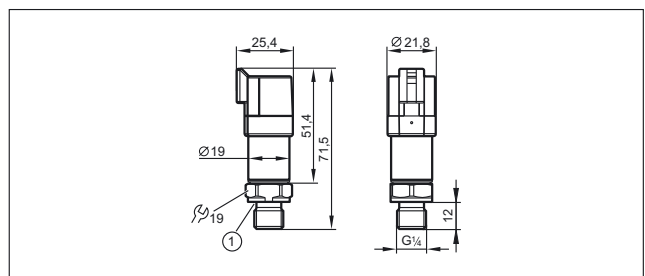

1: sealing FKM / DIN 3869

26

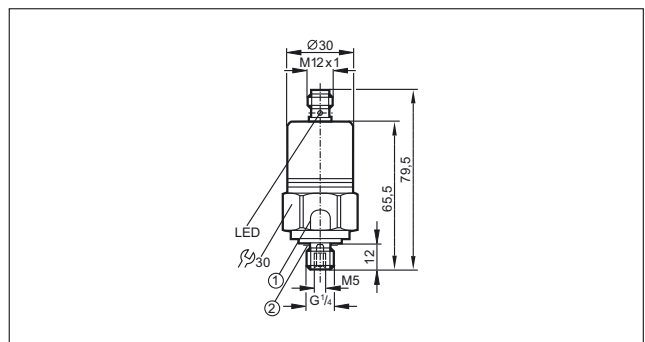

1: Pressure relief mechanism, No mechanical force must be exerted on the pressure relief mechanism., 2: sealing FPM / DIN 3869-14

27

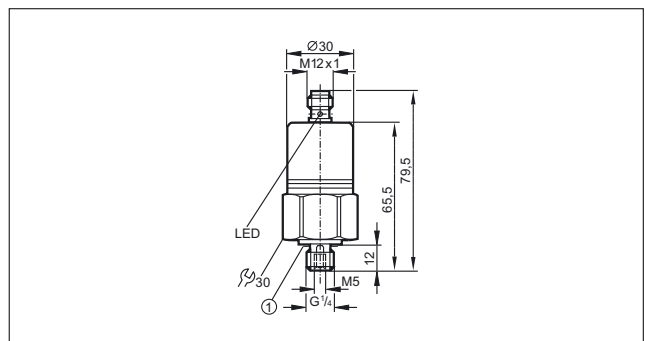

1: sealing FPM / DIN 3869-14

Scale drawings / drawing no. – CAD download: www.ifm.com

28

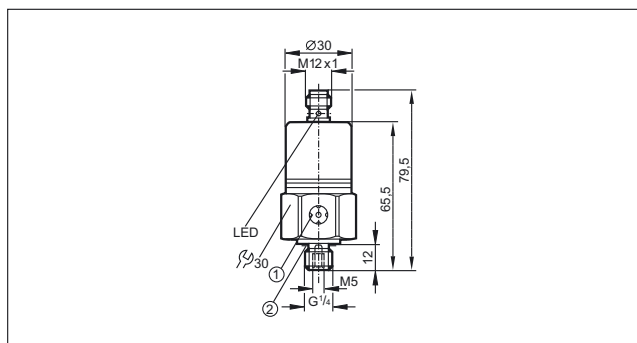

1: ventilation, 2: sealing FPM / DIN 3869-14

29

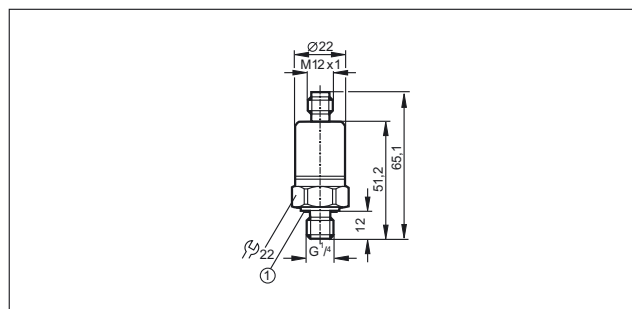

1: FKM seal / DIN 3869-14, tightening torque 25 Nm

Quickly and safely connected



Maximum operational reliability due to the new vibration protection with end stop.

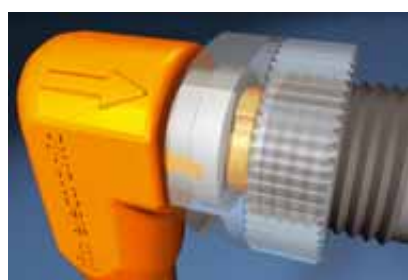

Connection technology

With a wide variety of different sensor designs ifm electronic offers a wide range of high quality connectors. The choice of types covers common M8, M12, M18 types through to valve plugs. The "ecolink" connectors (order no. EVxxxx) offer additional quality features.

ecolink – a new dimension in connection technology

The innovative design incorporating a mechanical end stop ensures that the O-ring is always correctly compressed and so permanently maintains its sealing function. The connector remains securely positioned on the unit even in case of extreme vibration and impacts. The use of a transparent black housing ensures that even in bright lighting conditions the LEDs are clearly visible.

For industrial applications

High-quality materials suited to the requirements in industrial environments. Largely resistant to oils, greases and coolants.

For hygienic and wet areas

PVC housing and cable, gold-plated contacts and high-grade stainless steel nuts are the optimum choice for long life.

For hazardous areas





Connection technology for ATEX categories 1D, 2D, 3D and 1G, 3G. With the EC type examination certificate for components from DEKRA EXAM the connection technology meets the strictest requirements.

For welding applications

Halogen-free PUR cables prevent burning-in of weld spatter; teflon-coated coupling nuts prevent weld spatter sticking. The cables are also suited for drag chains and torsional movements.

For sensors in robust applications

The saw tooth contoured vibration protection secures against strong shocks and vibrations. The high protection rating, wide temperature range and high-quality housing materials (high-grade stainless steel, TPU) ensure permanent safe connection in harsh environments.

	Sockets	738 - 765
	Plugs	766 - 770
	Jumper cables	772 - 804
	Splitter boxes	806 - 824
	Y-splitters	826 - 828



Sockets







Sockets are mainly used for the connection of sensors. High-quality socket contacts and materials ensure reliable electrical connections.

In addition to a wide range of standard products ifm also offers versions without silicone and halogen, versions for hygienic areas, for applications in contact with coolants and lubricants, as well as for welding applications.

System overview	Page
M8 sockets for industrial applications	738 - 740
M12 sockets for industrial applications	740 - 743
M12 sockets for industrial applications with screen	743 - 745
M16 sockets for industrial applications	745
M18 sockets for industrial applications	746
M23 sockets for industrial applications	746 - 747
1/2" sockets for industrial applications	747 - 748
7/8" sockets for industrial applications	748
DIN sockets for industrial applications	748
RD24 sockets for industrial applications	748 - 749
Connectors weld slag resistant	749 - 750
M12 cable sockets for hygienic and wet areas with screen	750 - 752
Connectors for hygienic and wet areas	752 - 755
Connectors for hazardous areas	756 - 757
Connectors for robust applications	757 - 758
Wiring diagrams	759 - 760
Scale drawings / drawing no. – CAD download: www.ifm.com	760 - 765

M8 sockets for industrial applications

Type	Cable	Wire specification	Material housing / nut	U [V]	T _a [°C]	Protection	LEDs	Drawing no.	Order no.
Group 1 · Socket M8, 3-pole, 3-wire · Wiring diagram no. 1									
	2 m black PUR cable	3 x 0.25 mm ² , Ø 3.7 mm	TPU / Brass	50 AC 60 DC	-25...90	IP 65 / IP 67 / IP 68 / IP 69K	–	1	EVC141

Type	Cable	Wire specification	Material housing / nut	U [V]	T _a [°C]	Protection	LEDs	Drawing no.	Order no.
Group 1 · Socket M8, 3-pole, 3-wire · Wiring diagram no. 1									
	5 m black PUR cable	3 x 0.25 mm ² , Ø 3.7 mm	TPU / Brass	50 AC 60 DC	-25...90	IP 65 / IP 67 / IP 68 / IP 69K	–	1	EVC142
	10 m black PUR cable	3 x 0.25 mm ² , Ø 3.7 mm	TPU / Brass	50 AC 60 DC	-25...90	IP 65 / IP 67 / IP 68 / IP 69K	–	1	EVC143
	2 m black PUR cable	3 x 0.25 mm ² , Ø 3.7 mm	TPU / Brass	50 AC 60 DC	-25...90	IP 65 / IP 67 / IP 68 / IP 69K	–	2	EVC144
	5 m black PUR cable	3 x 0.25 mm ² , Ø 3.7 mm	TPU / Brass	50 AC 60 DC	-25...90	IP 65 / IP 67 / IP 68 / IP 69K	–	2	EVC145
	10 m black PUR cable	3 x 0.25 mm ² , Ø 3.7 mm	TPU / Brass	50 AC 60 DC	-25...90	IP 65 / IP 67 / IP 68 / IP 69K	–	2	EVC146
Group 2 · Socket M8, 3-pole, 3-wire, LED, PNP · Wiring diagram no. 2									
	2 m black PUR cable	3 x 0.25 mm ² , Ø 3.7 mm	TPU / Brass	10...36 DC	-25...90	IP 65 / IP 67 / IP 68 / IP 69K	green / yellow	3	EVC147
	5 m black PUR cable	3 x 0.25 mm ² , Ø 3.7 mm	TPU / Brass	10...36 DC	-25...90	IP 65 / IP 67 / IP 68 / IP 69K	green / yellow	3	EVC148
	10 m black PUR cable	3 x 0.25 mm ² , Ø 3.7 mm	TPU / Brass	10...36 DC	-25...90	IP 65 / IP 67 / IP 68 / IP 69K	green / yellow	3	EVC149
Group 3 · Wirable socket M8, 3-pole · Wiring diagram no. 3									
	wirable	–	PA / Brass	60 AC 75 DC	-25...90	IP 68	–	–	E11552
Group 4 · Socket M8, 4-pole, 4-wire · Wiring diagram no. 4									
	2 m black PUR cable	4 x 0.25 mm ² , Ø 3.7 mm	TPU / Brass	50 AC 60 DC	-25...90	IP 65 / IP 67 / IP 68 / IP 69K	–	4	EVC150
	5 m black PUR cable	4 x 0.25 mm ² , Ø 3.7 mm	TPU / Brass	50 AC 60 DC	-25...90	IP 65 / IP 67 / IP 68 / IP 69K	–	4	EVC151
	10 m black PUR cable	4 x 0.25 mm ² , Ø 3.7 mm	TPU / Brass	50 AC 60 DC	-25...90	IP 65 / IP 67 / IP 68 / IP 69K	–	4	EVC152
	2 m black PUR cable	4 x 0.25 mm ² , Ø 3.7 mm	TPU / Brass	50 AC 60 DC	-25...90	IP 65 / IP 67 / IP 68 / IP 69K	–	5	EVC153

Connection technology

Type	Cable	Wire specification	Material housing / nut	U [V]	T _a [°C]	Protection	LEDs	Drawing no.	Order no.
------	-------	--------------------	------------------------	-------	---------------------	------------	------	-------------	-----------

Group 4 · Socket M8, 4-pole, 4-wire · Wiring diagram no. 4

	5 m black PUR cable	4 x 0.25 mm ² , Ø 3.7 mm	TPU / Brass	50 AC 60 DC	-25...90	IP 65 / IP 67 / IP 68 / IP 69K	–	5	EVC154
	10 m black PUR cable	4 x 0.25 mm ² , Ø 3.7 mm	TPU / Brass	50 AC 60 DC	-25...90	IP 65 / IP 67 / IP 68 / IP 69K	–	5	EVC155

Group 5 · Wirable socket M8, 4-pole · Wiring diagram no. 5

	wirable	–	PA / Brass	60 AC 75 DC	-25...90	IP 68	–	–	E11553
---	---------	---	------------	----------------	----------	-------	---	---	---------------



M12 sockets for industrial applications

Type	Cable	Wire specification	Material housing / nut	U [V]	T _a [°C]	Protection	LEDs	Drawing no.	Order no.
------	-------	--------------------	------------------------	-------	---------------------	------------	------	-------------	-----------







Group 6 · Socket M12, 5-pole, 2-wire · Wiring diagram no. 6



	2 m black PUR cable	2 x 0.34 mm ² , Ø 4.9 mm	TPU / Brass	250 AC 300 DC	-25...90	IP 65 / IP 67 / IP 68 / IP 69K	–	6	EVC164
	5 m black PUR cable	2 x 0.34 mm ² , Ø 4.9 mm	TPU / Brass	250 AC 300 DC	-25...90	IP 65 / IP 67 / IP 68 / IP 69K	–	6	EVC165
	10 m black PUR cable	2 x 0.34 mm ² , Ø 4.9 mm	TPU / Brass	250 AC 300 DC	-25...90	IP 65 / IP 67 / IP 68 / IP 69K	–	6	EVC166
	2 m black PUR cable	2 x 0.34 mm ² , Ø 4.9 mm	TPU / Brass	250 AC 300 DC	-25...90	IP 65 / IP 67 / IP 68 / IP 69K	–	7	EVC161
	5 m black PUR cable	2 x 0.34 mm ² , Ø 4.9 mm	TPU / Brass	250 AC 300 DC	-25...90	IP 65 / IP 67 / IP 68 / IP 69K	–	7	EVC162
	10 m black PUR cable	2 x 0.34 mm ² , Ø 4.9 mm	TPU / Brass	250 AC 300 DC	-25...90	IP 65 / IP 67 / IP 68 / IP 69K	–	7	EVC163



Group 7 · socket M12, 2-pole + PE, 3-wire · Wiring diagram no. 7

	2 m orange PVC cable	3 x AWG 22 (3 x 0.34 mm ²), Ø 5 mm	TPU / Brass	250 AC 300 DC	-25...90	IP 67	–	8	E10865
	5 m orange PVC cable	3 x AWG 22 (3 x 0.34 mm ²), Ø 5 mm	TPU / Brass	250 AC 300 DC	-25...90	IP 67	–	8	E10866
	2 m orange PVC cable	3 x AWG 22 (3 x 0.34 mm ²), Ø 5 mm	TPU / Brass	250 AC 300 DC	-25...90	IP 67	–	9	E10867

Type	Cable	Wire specification	Material housing / nut	U [V]	T _a [°C]	Protection	LEDs	Drawing no.	Order no.
Group 7 · socket M12, 2-pole + PE, 3-wire · Wiring diagram no. 7									
	5 m orange PVC cable	3 x AWG 22 (3 x 0.34 mm ²), Ø 5 mm	TPU / Brass	250 AC 300 DC	-25...90	IP 67	–	9	E10868
Group 8 · Wirable socket M12, 4-pole · Wiring diagram no. 5									
	wirable	...0.75 mm ² (Ø 4...6 mm)	PA / Brass	250 AC/DC	-25...85	IP 68	–	10	E11509
	wirable	...0.75 mm ² (Ø 4...6 mm)	PA / Brass	250 AC/DC	-25...85	IP 68	–	11	E11508
Group 9 · Wirable socket M12, 4-pole, LED, PNP · Wiring diagram no. 8									
	wirable	...0.75 mm ² (Ø 4...6 mm)	PA / Brass	10...30 DC	-25...85	IP 68	green / yellow	12	E11510
	wirable	...0.75 mm ² (Ø 4...6 mm)	PA	10...30 DC	-40...85	IP 67	green / yellow	11	E10136
Group 10 · Socket M12, 5/4-pole, 4-wire · Wiring diagram no. 4									
	2 m black PUR cable	4 x 0.34 mm ² , Ø 4.9 mm	TPU / Brass	250 AC 300 DC	-25...90	IP 65 / IP 67 / IP 68 / IP 69K	–	6	EVC004
	5 m black PUR cable	4 x 0.34 mm ² , Ø 4.9 mm	TPU / Brass	250 AC 300 DC	-25...90	IP 65 / IP 67 / IP 68 / IP 69K	–	6	EVC005
	10 m black PUR cable	4 x 0.34 mm ² , Ø 4.9 mm	TPU / Brass	250 AC 300 DC	-25...90	IP 65 / IP 67 / IP 68 / IP 69K	–	6	EVC006
	2 m black PUR cable	4 x 0.34 mm ² , Ø 4.9 mm	TPU / Brass	250 AC 300 DC	-25...90	IP 65 / IP 67 / IP 68 / IP 69K	–	7	EVC001
	5 m black PUR cable	4 x 0.34 mm ² , Ø 4.9 mm	TPU / Brass	250 AC 300 DC	-25...90	IP 65 / IP 67 / IP 68 / IP 69K	–	7	EVC002
	10 m black PUR cable	4 x 0.34 mm ² , Ø 4.9 mm	TPU / Brass	250 AC 300 DC	-25...90	IP 65 / IP 67 / IP 68 / IP 69K	–	7	EVC003
Group 11 · Socket M12, 5/4-pole, 4-wire, LED, PNP · Wiring diagram no. 9									
	2 m black PUR cable	4 x 0.34 mm ² , Ø 4.9 mm	TPU / Brass	10...36 DC	-25...90	IP 65 / IP 67 / IP 68 / IP 69K	green / 2 x yellow	13	EVC007
	5 m black PUR cable	4 x 0.34 mm ² , Ø 4.9 mm	TPU / Brass	10...36 DC	-25...90	IP 65 / IP 67 / IP 68 / IP 69K	green / 2 x yellow	13	EVC008

Type	Cable	Wire specification	Material housing / nut	U [V]	T _a [°C]	Protection	LEDs	Drawing no.	Order no.
Group 11 · Socket M12, 5/4-pole, 4-wire, LED, PNP · Wiring diagram no. 9									
	10 m black PUR cable	4 x 0.34 mm ² , Ø 4.9 mm	TPU / Brass	10...36 DC	-25...90	IP 65 / IP 67 / IP 68 / IP 69K	green / 2 x yellow	13	EVC009
Group 12 · Wirable socket M12, 5-pole · Wiring diagram no. 10									
	wirable	...0.75 mm ² (Ø 4...6 mm)	PA / Brass	125 AC/DC	-25...85	IP 68	–	14	E11512
	wirable	...0.75 mm ² (Ø 4...6 mm)	PA / Brass	125 AC/DC	-25...85	IP 68	–	15	E11511
Group 13 · Socket M12, 5-pole, 5-wire · Wiring diagram no. 11									
	2 m black PUR cable	5 x 0.34 mm ² , Ø 4.9 mm	TPU / Brass	60 AC 60 DC	-25...90	IP 65 / IP 67 / IP 68 / IP 69K	–	6	EVC073
	5 m black PUR cable	5 x 0.34 mm ² , Ø 4.9 mm	TPU / Brass	60 AC 60 DC	-25...90	IP 65 / IP 67 / IP 68 / IP 69K	–	6	EVC074
	10 m black PUR cable	5 x 0.34 mm ² , Ø 4.9 mm	TPU / Brass	60 AC 60 DC	-25...90	IP 65 / IP 67 / IP 68 / IP 69K	–	6	EVC075
	2 m black PUR cable	5 x 0.34 mm ² , Ø 4.9 mm	TPU / Brass	60 AC 60 DC	-25...90	IP 65 / IP 67 / IP 68 / IP 69K	–	7	EVC070
	5 m black PUR cable	5 x 0.34 mm ² , Ø 4.9 mm	TPU / Brass	60 AC 60 DC	-25...90	IP 65 / IP 67 / IP 68 / IP 69K	–	7	EVC071
	10 m black PUR cable	5 x 0.34 mm ² , Ø 4.9 mm	TPU / Brass	60 AC 60 DC	-25...90	IP 65 / IP 67 / IP 68 / IP 69K	–	7	EVC072
Group 14 · Socket M12, 8-pole, 6-wire · Wiring diagram no. 12									
	5 m black PUR cable	6 x 0.34 mm ² , Ø 6 mm	TPU / diecast zinc	60 AC/DC	-25...85	IP 68	–	16	E10976
	10 m black PUR cable	6 x 0.34 mm ² , Ø 6 mm	TPU / diecast zinc	60 AC/DC	-25...85	IP 68	–	16	E10977
Group 15 · socket M12, 8-pole, 7-wire + screen · Wiring diagram no. 13									
	2 m black PUR cable	7 x 0.25 mm ² + screen	TPU / diecast zinc	60 AC/DC	-25...85	IP 67	–	16	E20738
	5 m black PUR cable	7 x 0.25 mm ² + screen	TPU / diecast zinc	60 AC/DC	-25...85	IP 67	–	17	E20838

Type	Cable	Wire specification	Material housing / nut	U [V]	T _a [°C]	Protection	LEDs	Drawing no.	Order no.
Group 16 · Socket M12, 8/7-pole, 8-wire · Wiring diagram no. 14									
	2 m black PUR cable	8 x 0.25 mm ² , Ø 6.2 mm	PUR / Brass	30 AC 36 DC	-25...80	IP 67	–	18	E11231
	5 m black PUR cable	8 x 0.25 mm ² , Ø 6.2 mm	PUR / Brass	30 AC 36 DC	-25...80	IP 67	–	18	E11232
	2 m black PUR cable	8 x 0.25 mm ² , Ø 6.2 mm	PUR / Brass	30 AC 36 DC	-25...80	IP 68	–	19	E11950
	5 m black PUR cable	8 x 0.25 mm ² , Ø 6.2 mm	PUR / Brass	30 AC 36 DC	-25...80	IP 68	–	19	E11807
	10 m black PUR cable	8 x 0.25 mm ² , Ø 6.2 mm	PUR / Brass	30 AC 36 DC	-25...80	IP 68	–	19	E11311

Type	Cable	Wire specification	Material housing / nut	U [V]	T _a [°C]	Protection	LEDs	Drawing no.	Order no.
Group 17 · Socket M12, 8/7-pole, 8-wire · Wiring diagram no. 15									
	5 m black PUR cable	8 x 0.25 mm ²	TPU / Brass	30 AC 36 DC	-40...80	IP 68	–	18	E12168
	10 m black PUR cable	8 x 0.25 mm ²	TPU / Brass	30 AC 36 DC	-40...80	IP 68	–	18	E12169
	5 m black PUR cable	8 x 0.25 mm ²	TPU / Brass	30 AC 36 DC	-40...80	IP 67	–	19	E12166
	10 m black PUR cable	8 x 0.25 mm ²	TPU / Brass	30 AC 36 DC	-40...80	IP 67	–	19	E12167

M12 sockets for industrial applications with screen

Type	Cable	Wire specification	Material housing / nut	U [V]	T _a [°C]	Protection	LEDs	Drawing no.	Order no.
Group 18 · Socket M12, halogen-free, screened, screen not connected to the socket, 5/4-pole, 4-wire · Wiring diagram no. 16									
	2 m black PUR cable	4 x 0.34 mm ² , Ø 4.9 mm	TPU / Brass	50 AC 60 DC	-25...90	IP 65 / IP 67 / IP 68 / IP 69K	–	7	EVC526
	5 m black PUR cable	4 x 0.34 mm ² , Ø 4.9 mm	TPU / Brass	50 AC 60 DC	-25...90	IP 65 / IP 67 / IP 68 / IP 69K	–	7	EVC527
	10 m black PUR cable	4 x 0.34 mm ² , Ø 4.9 mm	TPU / Brass	50 AC 60 DC	-25...90	IP 65 / IP 67 / IP 68 / IP 69K	–	7	EVC528

Type	Cable	Wire specification	Material housing / nut	U [V]	T _a [°C]	Protection	LEDs	Drawing no.	Order no.
Group 18 · Socket M12, halogen-free, screened, screen not connected to the socket, 5/4-pole, 4-wire · Wiring diagram no. 16									
	2 m black PUR cable	4 x 0.34 mm ² , Ø 4.9 mm	TPU / Brass	50 AC 60 DC	-25...90	IP 65 / IP 67 / IP 68 / IP 69K	–	6	EVC529
	5 m black PUR cable	4 x 0.34 mm ² , Ø 4.9 mm	TPU / Brass	50 AC 60 DC	-25...90	IP 65 / IP 67 / IP 68 / IP 69K	–	6	EVC530
	10 m black PUR cable	4 x 0.34 mm ² , Ø 4.9 mm	TPU / Brass	50 AC 60 DC	-25...90	IP 65 / IP 67 / IP 68 / IP 69K	–	6	EVC531
Group 19 · Socket M12, halogen-free, screened, screen not connected to the socket, 5-pole, 5-wire · Wiring diagram no. 17									
	2 m black PUR cable	5 x 0.25 mm ² , Ø 4.9 mm	TPU / Brass	30 AC 36 DC	-25...90	IP 65 / IP 67 / IP 68 / IP 69K	–	7	EVC532
	5 m black PUR cable	5 x 0.25 mm ² , Ø 4.9 mm	TPU / Brass	30 AC 36 DC	-25...90	IP 65 / IP 67 / IP 68 / IP 69K	–	7	EVC533
	10 m black PUR cable	5 x 0.25 mm ² , Ø 4.9 mm	TPU / Brass	30 AC 36 DC	-25...90	IP 65 / IP 67 / IP 68 / IP 69K	–	7	EVC534
	2 m black PUR cable	5 x 0.25 mm ² , Ø 4.9 mm	TPU / Brass	30 AC 36 DC	-25...90	IP 65 / IP 67 / IP 68 / IP 69K	–	6	EVC535
	5 m black PUR cable	5 x 0.25 mm ² , Ø 4.9 mm	TPU / Brass	30 AC 36 DC	-25...90	IP 65 / IP 67 / IP 68 / IP 69K	–	6	EVC536
	10 m black PUR cable	5 x 0.25 mm ² , Ø 4.9 mm	TPU / Brass	30 AC 36 DC	-25...90	IP 65 / IP 67 / IP 68 / IP 69K	–	6	EVC537
Group 20 · Socket M12, halogen-free, screened, screen connected to the socket, 5/4-pole, 4-wire · Wiring diagram no. 18									
	2 m black PUR cable	4 x 0.34 mm ² , Ø 4.9 mm	TPU / Brass	50 AC 60 DC	-25...90	IP 65 / IP 67	–	7	EVC538
	5 m black PUR cable	4 x 0.34 mm ² , Ø 4.9 mm	TPU / Brass	50 AC 60 DC	-25...90	IP 65 / IP 67	–	7	EVC539
	10 m black PUR cable	4 x 0.34 mm ² , Ø 4.9 mm	TPU / Brass	50 AC 60 DC	-25...90	IP 65 / IP 67	–	7	EVC540
	2 m black PUR cable	4 x 0.34 mm ² , Ø 4.9 mm	TPU / Brass	50 AC 60 DC	-25...90	IP 65 / IP 67	–	6	EVC541
	5 m black PUR cable	4 x 0.34 mm ² , Ø 4.9 mm	TPU / Brass	50 AC 60 DC	-25...90	IP 65 / IP 67	–	6	EVC542

Type	Cable	Wire specification	Material housing / nut	U [V]	T _a [°C]	Protection	LEDs	Drawing no.	Order no.
------	-------	--------------------	------------------------	-------	---------------------	------------	------	-------------	-----------

Group 20 · Socket M12, halogen-free, screened, screen connected to the socket, 5/4-pole, 4-wire · Wiring diagram no. 18

	10 m black PUR cable	4 x 0.34 mm ² , Ø 4.9 mm	TPU / Brass	50 AC 60 DC	-25...90	IP 65 / IP 67	–	6	EVC543
---	----------------------	-------------------------------------	-------------	----------------	----------	---------------	---	---	---------------

Group 21 · Socket M12, halogen-free, screened, screen connected to the socket, 5-pole, 5-wire · Wiring diagram no. 19

	2 m black PUR cable	5 x 0.25 mm ² , Ø 4.9 mm	TPU / Brass	30 AC 36 DC	-25...90	IP 65 / IP 67	–	7	EVC544
	5 m black PUR cable	5 x 0.25 mm ² , Ø 4.9 mm	TPU / Brass	30 AC 36 DC	-25...90	IP 65 / IP 67	–	7	EVC545
	10 m black PUR cable	5 x 0.25 mm ² , Ø 4.9 mm	TPU / Brass	30 AC 36 DC	-25...90	IP 65 / IP 67	–	7	EVC546
	2 m black PUR cable	5 x 0.25 mm ² , Ø 4.9 mm	TPU / Brass	30 AC 36 DC	-25...90	IP 65 / IP 67	–	6	EVC547
	5 m black PUR cable	5 x 0.25 mm ² , Ø 4.9 mm	TPU / Brass	30 AC 36 DC	-25...90	IP 65 / IP 67	–	6	EVC548
	10 m black PUR cable	5 x 0.25 mm ² , Ø 4.9 mm	TPU / Brass	30 AC 36 DC	-25...90	IP 65 / IP 67	–	6	EVC549

M16 sockets for industrial applications

Type	Cable	Wire specification	Material housing / nut	U [V]	T _a [°C]	Protection	LEDs	Drawing no.	Order no.
------	-------	--------------------	------------------------	-------	---------------------	------------	------	-------------	-----------



Group 22 · socket M16, 14-pole, 10-wire · Wiring diagram no. 20

	5 m black PUR cable	8 x 0.34 mm ² + 2 x 0.75 mm ² , Ø 9.1 mm	PUR / Brass	30 DC	-25...90	IP 68	–	20	E11226
	10 m black PUR cable	8 x 0.34 mm ² + 2 x 0.75 mm ² , Ø 9.1 mm	PUR / Brass	30 DC	-25...90	IP 68	–	20	E11227



Group 23 · Socket M16, 14-pole, 12-wire · Wiring diagram no. 21

	2 m black PUR cable	2 x 0.34 mm ² + 9 x 0.25 mm ² , Ø 7.5 mm	PUR / Brass	30 DC	-25...90	IP 67	–	21	E11645
	5 m black PUR cable	2 x 0.34 mm ² + 9 x 0.25 mm ² , Ø 7.5 mm	PUR / Brass	30 DC	-25...90	IP 67	–	21	E11697



M18 sockets for industrial applications

Type	Cable	Wire specification	Material housing / nut	U [V]	T _a [°C]	Protection	LEDs	Drawing no.	Order no.
Group 24 · Wirable socket M18, 4-pole · Wiring diagram no. 5									
	wirable	...0.75 mm ² (Ø 6...8 mm)	PA	20...250 AC/DC	-40...85	IP 65	–	22	E10013
	wirable	...0.75 mm ² (Ø 6...8 mm)	PA / ULTRAMID	20...250 AC/DC	-40...85	IP 65	–	23	E10137

M23 sockets for industrial applications



Type	Cable	Wire specification	Material housing / nut	U [V]	T _a [°C]	Protection	LEDs	Drawing no.	Order no.
Group 25 · Socket M23, 12-pole, 12-wire · Wiring diagram no. 22									
	5 m black PUR cable	8 x 0.5 mm ² + 3 x 1.0 mm ² , Ø 9.3 mm	PUR / Brass	63 AC/DC	-25...80	IP 67	–	24	E11739
	10 m black PUR cable	8 x 0.5 mm ² + 3 x 1.0 mm ² , Ø 9.3 mm	PUR / Brass	63 AC/DC	-25...80	IP 67	–	24	E11740
	15 m black PUR cable	8 x 0.5 mm ² + 3 x 1.0 mm ² , Ø 9.3 mm	PUR / Brass	63 AC/DC	-25...80	IP 67	–	24	E11741
	5 m black PUR cable	8 x 0.5 mm ² + 3 x 1.0 mm ² , Ø 9.3 mm	PUR / Brass	63 AC/DC	-25...80	IP 67	–	25	E11736
	10 m black PUR cable	8 x 0.5 mm ² + 3 x 1.0 mm ² , Ø 9.3 mm	PUR / Brass	63 AC/DC	-25...80	IP 67	–	25	E11737
	15 m black PUR cable	8 x 0.5 mm ² + 3 x 1.0 mm ² , Ø 9.3 mm	PUR / Brass	63 AC/DC	-25...80	IP 67	–	25	E11738

Group 26 · Wirable M23 socket, 12 poles



	wirable	...1 mm ² (Ø 10...14 mm)	Brass	10...30 DC	-25...90	IP 65	–	26	E10448
	wirable	...1 mm ² (Ø 10...14 mm)	Brass	10...30 DC	-25...90	IP 65	–	27	E10447

Group 27 · Socket M23, 19-pole, 19-wire · Wiring diagram no. 28

	5 m black PUR cable	16 x 0.5 mm ² + 3 x 1.0 mm ² , Ø 11.6 mm	PUR / Brass	63 AC/DC	-25...80	IP 67	–	28	E11745
---	---------------------	--	-------------	----------	----------	-------	---	----	---------------

Type	Cable	Wire specification	Material housing / nut	U [V]	T _a [°C]	Protection	LEDs	Drawing no.	Order no.
Group 27 · Socket M23, 19-pole, 19-wire · Wiring diagram no. 28									
	10 m black PUR cable	16 x 0.5 mm ² + 3 x 1.0 mm ² , Ø 11.6 mm	PUR / Brass	63 AC/DC	-25...80	IP 67	–	28	E11746
	15 m black PUR cable	16 x 0.5 mm ² + 3 x 1.0 mm ² , Ø 11.6 mm	PUR / Brass	63 AC/DC	-25...80	IP 67	–	28	E11747
	5 m black PUR cable	16 x 0.5 mm ² + 3 x 1.0 mm ² , Ø 11.6 mm	PUR / Brass	63 AC/DC	-25...80	IP 67	–	29	E11742
	10 m black PUR cable	16 x 0.5 mm ² + 3 x 1.0 mm ² , Ø 11.6 mm	PUR / Brass	63 AC/DC	-25...80	IP 67	–	29	E11743
	15 m black PUR cable	16 x 0.5 mm ² + 3 x 1.0 mm ² , Ø 11.6 mm	PUR / Brass	63 AC/DC	-25...80	IP 67	–	29	E11744



Group 28 · Wirable socket M23, 19-pole

	wirable	...1 mm ² (Ø 10...14 mm)	Brass	10...30 DC	-25...90	IP 65	–	–	E10887
	wirable	...1 mm ² (Ø 10...14 mm)	Brass	10...30 DC	-25...90	IP 65	–	–	E10886



1/2" sockets for industrial applications

Type	Cable	Wire specification	Material housing / nut	U [V]	T _a [°C]	Protection	LEDs	Drawing no.	Order no.
Group 29 · socket 1/2", 2-pole + PE, 3-wire · Wiring diagram no. 23									
	2 m yellow PVC cable	3 x AWG 22, Ø 5.2 mm	TPU / Brass	250 AC 300 DC	-25...90	IP 67	–	30	E10190
	5 m yellow PVC cable	3 x AWG 22, Ø 5.2 mm	TPU / Brass	250 AC 300 DC	-25...90	IP 67	–	31	E10200
	2 m yellow PVC cable	3 x AWG 22, Ø 5.2 mm	TPU / Brass	250 AC 300 DC	-25...90	IP 67	–	32	E10189
	5 m yellow PVC cable	3 x AWG 22, Ø 5.2 mm	TPU / Brass	250 AC 300 DC	-25...90	IP 67	–	33	E10191
	10 m yellow PVC cable	3 x AWG 22, Ø 5.2 mm	TPU / Brass	250 AC 300 DC	-25...90	IP 67	–	31	E10261

Connection technology

Type	Cable	Wire specification	Material housing / nut	U [V]	T _a [°C]	Protection	LEDs	Drawing no.	Order no.
Group 30 · socket 1/2", 5-pole, 4-wire · Wiring diagram no. 24									
	5 m black PUR cable	4 x 0.34 mm ² , Ø 4.7 mm	TPU / Brass	300 AC	-25...90	IP 67	–	34	E11248
	10 m black PUR cable	4 x 0.34 mm ² , Ø 4.7 mm	TPU / Brass	300 AC	-25...90	IP 67	–	34	E11249
	5 m black PUR cable	4 x 0.34 mm ² , Ø 4.7 mm	TPU / Brass	300 AC	-25...90	IP 67	–	35	E11250
	10 m black PUR cable	4 x 0.34 mm ² , Ø 4.7 mm	TPU / Brass	300 AC	-25...90	IP 67	–	36	E11251

7/8" sockets for industrial applications

Type	Cable	Wire specification	Material housing / nut	U [V]	T _a [°C]	Protection	LEDs	Drawing no.	Order no.
Group 31 · socket 7/8", 2-pole + PE, 3-wire									
	2 m black PVC cable	3 x 0.75 mm ² , Ø 5.2 mm	TPU / diecast zinc	250 AC	-40...80	IP 68	–	37	E20428
Group 32 · socket 7/8", 3-pole, 3-wire									
	2 m black PVC cable	3 x 0.5 mm ² , Ø 5.4 mm	TPU	10...30 DC	-40...80	IP 68	–	37	E20430

DIN sockets for industrial applications

Type	Cable	Wire specification	Material housing / nut	U [V]	T _a [°C]	Protection	LEDs	Drawing no.	Order no.
Group 33 · socket DIN A (DIN EN 175301-803) · Wiring diagram no. 25									
	wirable	...1.5 mm ² (Ø 6...8 mm)	PA	...250 AC ...300 DC	-40...125	IP 65	–	38	E10058

RD24 sockets for industrial applications

Type	Cable	Wire specification	Material housing / nut	U [V]	T _a [°C]	Protection	LEDs	Drawing no.	Order no.
Group 34 · socket Rd24, 6-pole + PE · Wiring diagram no. 26									
	wirable	...2.5 mm ² (Ø 10...12 mm)	PBT	250 AC 300 DC	-40...100	IP 67	–	39	E70142

Type	Cable	Wire specification	Material housing / nut	U [V]	T _a [°C]	Protection	LEDs	Drawing no.	Order no.
------	-------	--------------------	------------------------	-------	---------------------	------------	------	-------------	-----------

Group 34 · socket Rd24, 6-pole + PE · Wiring diagram no. 26

	wirable	...2.5 mm ² (Ø 6...8 mm)	PBT / PA	250 AC 300 DC	-40...100	IP 67	–	40	E11043
---	---------	-------------------------------------	----------	------------------	-----------	-------	---	----	--------

Connectors weld slag resistant

Type	Cable	Wire specification	Material housing / nut	U [V]	T _a [°C]	Protection	LEDs	Drawing no.	Order no.
------	-------	--------------------	------------------------	-------	---------------------	------------	------	-------------	-----------

Group 114 · Socket M12, 5/4-pole, 4-wire · Wiring diagram no. 4

	2 m grey PUR cable	4 x 0.34 mm ² , Ø 4.9 mm	TPU / Brass	250 AC 300 DC	-25...90	IP 65 / IP 67 / IP 68 / IP 69K	–	6	EVW004
	5 m grey PUR cable	4 x 0.34 mm ² , Ø 4.9 mm	TPU / Brass	250 AC 300 DC	-25...90	IP 65 / IP 67 / IP 68 / IP 69K	–	6	EVW005
	10 m grey PUR cable	4 x 0.34 mm ² , Ø 4.9 mm	TPU / Brass	250 AC 300 DC	-25...90	IP 65 / IP 67 / IP 68 / IP 69K	–	6	EVW006
	2 m grey PUR cable	4 x 0.34 mm ² , Ø 4.9 mm	TPU / Brass	250 AC 300 DC	-25...90	IP 65 / IP 67 / IP 68 / IP 69K	–	7	EVW001
	5 m grey PUR cable	4 x 0.34 mm ² , Ø 4.9 mm	TPU / Brass	250 AC 300 DC	-25...90	IP 65 / IP 67 / IP 68 / IP 69K	–	7	EVW002
	10 m grey PUR cable	4 x 0.34 mm ² , Ø 4.9 mm	TPU / Brass	250 AC 300 DC	-25...90	IP 65 / IP 67 / IP 68 / IP 69K	–	7	EVW003

Group 115 · Socket M12, 5/4-pole, 4-wire, LED, PNP · Wiring diagram no. 9

	2 m grey PUR cable	4 x 0.34 mm ² , Ø 4.9 mm	TPU / Brass	10...36 DC	-25...90	IP 65 / IP 67 / IP 68 / IP 69K	green / 2 x yellow	13	EVW007
	5 m grey PUR cable	4 x 0.34 mm ² , Ø 4.9 mm	TPU / Brass	10...36 DC	-25...90	IP 65 / IP 67 / IP 68 / IP 69K	green / 2 x yellow	13	EVW008
	10 m grey PUR cable	4 x 0.34 mm ² , Ø 4.9 mm	TPU / Brass	10...36 DC	-25...90	IP 65 / IP 67 / IP 68 / IP 69K	green / 2 x yellow	13	EVW009

Group 116 · Socket M12, 5/4-pole, 5-wire · Wiring diagram no. 11

	2 m grey PUR cable	5 x 0.34 mm ² , Ø 5.1 mm	TPU / Brass	60 AC 60 DC	-25...90	IP 65 / IP 67 / IP 68 / IP 69K	–	6	EVW013
	5 m grey PUR cable	5 x 0.34 mm ² , Ø 5.1 mm	TPU / Brass	60 AC 60 DC	-25...90	IP 65 / IP 67 / IP 68 / IP 69K	–	6	EVW014

Connection technology

Type	Cable	Wire specification	Material housing / nut	U [V]	T _a [°C]	Protection	LEDs	Drawing no.	Order no.
------	-------	--------------------	------------------------	-------	---------------------	------------	------	-------------	-----------

Group 116 · Socket M12, 5/4-pole, 5-wire · Wiring diagram no. 11

	10 m grey PUR cable	5 x 0.34 mm ² , Ø 5.1 mm	TPU / Brass	60 AC 60 DC	-25...90	IP 65 / IP 67 / IP 68 / IP 69K	-	6	EVW015
---	---------------------	-------------------------------------	-------------	----------------	----------	-----------------------------------	---	---	--------



Group 117 · Socket M12, 5/4-pole, 5-wire · Wiring diagram no. 11





	2 m grey PUR cable	5 x 0.34 mm ² , Ø 5.1 mm	TPU / Brass	60 AC 60 DC	-25...90	IP 65 / IP 67 / IP 68 / IP 69K	-	7	EVW010
	5 m grey PUR cable	5 x 0.34 mm ² , Ø 5.1 mm	TPU / Brass	60 AC 60 DC	-25...90	IP 65 / IP 67 / IP 68 / IP 69K	-	7	EVW011
	10 m grey PUR cable	5 x 0.34 mm ² , Ø 5.1 mm	TPU / Brass	60 AC 60 DC	-25...90	IP 65 / IP 67 / IP 68 / IP 69K	-	7	EVW012

M12 cable sockets for hygienic and wet areas with screen

Type	Cable	Wire specification	Material housing / nut	U [V]	T _a [°C]	Protection	LEDs	Drawing no.	Order no.
------	-------	--------------------	------------------------	-------	---------------------	------------	------	-------------	-----------

Group 120 · Socket M12, screened, screen not connected to the socket, 5/4-pole, 4-wire · Wiring diagram no. 16

	2 m orange PVC cable	4 x 0.34 mm ² , Ø 5.2 mm	PVC / stainless steel 316L / 1.4404	50 AC 60 DC	-25...100	IP 65 / IP 67 / IP 68 / IP 69K	-	41	EVT381
	5 m orange PVC cable	4 x 0.34 mm ² , Ø 5.2 mm	PVC / stainless steel 316L / 1.4404	50 AC 60 DC	-25...100	IP 65 / IP 67 / IP 68 / IP 69K	-	41	EVT382
	10 m orange PVC cable	4 x 0.34 mm ² , Ø 5.2 mm	PVC / stainless steel 316L / 1.4404	50 AC 60 DC	-25...100	IP 65 / IP 67 / IP 68 / IP 69K	-	41	EVT383
	25 m orange PVC cable	4 x 0.34 mm ² , Ø 5.2 mm	PVC / stainless steel 316L / 1.4404	50 AC 60 DC	-25...100	IP 65 / IP 67 / IP 68 / IP 69K	-	41	EVT384
	2 m orange PVC cable	4 x 0.34 mm ² , Ø 5.2 mm	PVC / stainless steel 316L / 1.4404	50 AC 60 DC	-25...100	IP 65 / IP 67 / IP 68 / IP 69K	-	43	EVT385
	5 m orange PVC cable	4 x 0.34 mm ² , Ø 5.2 mm	PVC / stainless steel 316L / 1.4404	50 AC 60 DC	-25...100	IP 65 / IP 67 / IP 68 / IP 69K	-	43	EVT386
	10 m orange PVC cable	4 x 0.34 mm ² , Ø 5.2 mm	PVC / stainless steel 316L / 1.4404	50 AC 60 DC	-25...100	IP 65 / IP 67 / IP 68 / IP 69K	-	43	EVT387
	25 m orange PVC cable	4 x 0.34 mm ² , Ø 5.2 mm	PVC / stainless steel 316L / 1.4404	50 AC 60 DC	-25...100	IP 65 / IP 67 / IP 68 / IP 69K	-	43	EVT388

Type	Cable	Wire specification	Material housing / nut	U [V]	T _a [°C]	Protection	LEDs	Drawing no.	Order no.
Group 122 · Socket M12, screened, screen not connected to the socket, 5-pole, 5-wire · Wiring diagram no. 17									
	2 m orange PVC cable	5 x 0.25 mm ² , Ø 5.2 mm	PVC / stainless steel 316L / 1.4404	30 AC 36 DC	-25...100	IP 65 / IP 67 / IP 68 / IP 69K	-	41	EVT389
	5 m orange PVC cable	5 x 0.25 mm ² , Ø 5.2 mm	PVC / stainless steel 316L / 1.4404	30 AC 36 DC	-25...100	IP 65 / IP 67 / IP 68 / IP 69K	-	41	EVT390
	10 m orange PVC cable	5 x 0.25 mm ² , Ø 5.2 mm	PVC / stainless steel 316L / 1.4404	30 AC 36 DC	-25...100	IP 65 / IP 67 / IP 68 / IP 69K	-	41	EVT391
	25 m orange PVC cable	5 x 0.25 mm ² , Ø 5.2 mm	PVC / stainless steel 316L / 1.4404	30 AC 36 DC	-25...100	IP 65 / IP 67 / IP 68 / IP 69K	-	41	EVT392
	2 m orange PVC cable	5 x 0.25 mm ² , Ø 5.2 mm	PVC / stainless steel 316L / 1.4404	30 AC 36 DC	-25...100	IP 65 / IP 67 / IP 68 / IP 69K	-	43	EVT393
	5 m orange PVC cable	5 x 0.25 mm ² , Ø 5.2 mm	PVC / stainless steel 316L / 1.4404	30 AC 36 DC	-25...100	IP 65 / IP 67 / IP 68 / IP 69K	-	43	EVT394
	10 m orange PVC cable	5 x 0.25 mm ² , Ø 5.2 mm	PVC / stainless steel 316L / 1.4404	30 AC 36 DC	-25...100	IP 65 / IP 67 / IP 68 / IP 69K	-	43	EVT395
	25 m orange PVC cable	5 x 0.25 mm ² , Ø 5.2 mm	PVC / stainless steel 316L / 1.4404	30 AC 36 DC	-25...100	IP 65 / IP 67 / IP 68 / IP 69K	-	43	EVT396
Group 124 · Socket M12, screened, screen connected to the socket, 5/4-pole, 4-wire · Wiring diagram no. 18									
	2 m orange PVC cable	4 x 0.34 mm ² , Ø 5.2 mm	PVC / stainless steel 316L / 1.4404	50 AC 60 DC	-25...100	IP 65 / IP 67 / IP 68 / IP 69K	-	41	EVT397
	5 m orange PVC cable	4 x 0.34 mm ² , Ø 5.2 mm	PVC / stainless steel 316L / 1.4404	50 AC 60 DC	-25...100	IP 65 / IP 67 / IP 68 / IP 69K	-	41	EVT398
	10 m orange PVC cable	4 x 0.34 mm ² , Ø 5.2 mm	PVC / stainless steel 316L / 1.4404	50 AC 60 DC	-25...100	IP 65 / IP 67 / IP 68 / IP 69K	-	41	EVT399
	25 m orange PVC cable	4 x 0.34 mm ² , Ø 5.2 mm	PVC / stainless steel 316L / 1.4404	50 AC 60 DC	-25...100	IP 65 / IP 67 / IP 68 / IP 69K	-	41	EVT400
	2 m orange PVC cable	4 x 0.34 mm ² , Ø 5.2 mm	PVC / stainless steel 316L / 1.4404	50 AC 60 DC	-25...100	IP 65 / IP 67 / IP 68 / IP 69K	-	43	EVT401
	5 m orange PVC cable	4 x 0.34 mm ² , Ø 5.2 mm	PVC / stainless steel 316L / 1.4404	50 AC 60 DC	-25...100	IP 65 / IP 67 / IP 68 / IP 69K	-	43	EVT402
	10 m orange PVC cable	4 x 0.34 mm ² , Ø 5.2 mm	PVC / stainless steel 316L / 1.4404	50 AC 60 DC	-25...100	IP 65 / IP 67 / IP 68 / IP 69K	-	43	EVT403



Connection technology

Type	Cable	Wire specification	Material housing / nut	U [V]	T _a [°C]	Protection	LEDs	Drawing no.	Order no.
------	-------	--------------------	------------------------	-------	---------------------	------------	------	-------------	-----------



Group 124 · Socket M12, screened, screen connected to the socket, 5/4-pole, 4-wire · Wiring diagram no. 18

	25 m orange PVC cable	4 x 0.34 mm ² , Ø 5.2 mm	PVC / stainless steel 316L / 1.4404	50 AC 60 DC	-25...100	IP 65 / IP 67 / IP 68 / IP 69K	–	43	EVT404
---	-----------------------	-------------------------------------	-------------------------------------	----------------	-----------	--------------------------------	---	----	--------

Group 126 · Socket M12, screened, screen connected to the socket, 5-pole, 5-wire · Wiring diagram no. 19

	2 m orange PVC cable	5 x 0.25 mm ² , Ø 5.2 mm	PVC / stainless steel 316L / 1.4404	30 AC 36 DC	-25...100	IP 65 / IP 67 / IP 68 / IP 69K	–	41	EVT405
	5 m orange PVC cable	5 x 0.25 mm ² , Ø 5.2 mm	PVC / stainless steel 316L / 1.4404	30 AC 36 DC	-25...100	IP 65 / IP 67 / IP 68 / IP 69K	–	41	EVT406
	10 m orange PVC cable	5 x 0.25 mm ² , Ø 5.2 mm	PVC / stainless steel 316L / 1.4404	30 AC 36 DC	-25...100	IP 65 / IP 67 / IP 68 / IP 69K	–	41	EVT407
	25 m orange PVC cable	5 x 0.25 mm ² , Ø 5.2 mm	PVC / stainless steel 316L / 1.4404	30 AC 36 DC	-25...100	IP 65 / IP 67 / IP 68 / IP 69K	–	41	EVT408
	2 m orange PVC cable	5 x 0.25 mm ² , Ø 5.2 mm	PVC / stainless steel 316L / 1.4404	30 AC 36 DC	-25...100	IP 65 / IP 67 / IP 68 / IP 69K	–	43	EVT409
	5 m orange PVC cable	5 x 0.25 mm ² , Ø 5.2 mm	PVC / stainless steel 316L / 1.4404	30 AC 36 DC	-25...100	IP 65 / IP 67 / IP 68 / IP 69K	–	43	EVT410
	10 m orange PVC cable	5 x 0.25 mm ² , Ø 5.2 mm	PVC / stainless steel 316L / 1.4404	30 AC 36 DC	-25...100	IP 65 / IP 67 / IP 68 / IP 69K	–	43	EVT411
	25 m orange PVC cable	5 x 0.25 mm ² , Ø 5.2 mm	PVC / stainless steel 316L / 1.4404	30 AC 36 DC	-25...100	IP 65 / IP 67 / IP 68 / IP 69K	–	43	EVT412

Group 128 · Wirable socket M12, 5-pole · Wiring diagram no. 10





	wirable	...0.75 mm ² (Ø 4...6 mm)	PA / high-grade st. steel	60 AC/DC	-25...85	IP 67	–	51	E11865
	wirable	...0.75 mm ² (Ø 4...6 mm)	PA / high-grade st. steel	60 AC/DC	-25...90	IP 67	–	52	E11864





Connectors for hygienic and wet areas





Type	Cable	Wire specification	Material housing / nut	U [V]	T _a [°C]	Protection	LEDs	Drawing no.	Order no.
------	-------	--------------------	------------------------	-------	---------------------	------------	------	-------------	-----------

Group 120 · Socket M8, 3-pole, 3-wire · Wiring diagram no. 1



	2 m orange PVC cable	3 x 0.34 mm ² , Ø 4.9 mm	PVC / stainless steel 316L / 1.4404	50 AC 60 DC	-25...80	IP 65 / IP 67 / IP 68 / IP 69K	–	42	EVT122
---	----------------------	-------------------------------------	-------------------------------------	----------------	----------	--------------------------------	---	----	--------



Type	Cable	Wire specification	Material housing / nut	U [V]	T _a [°C]	Protection	LEDs	Drawing no.	Order no.
Group 120 · Socket M8, 3-pole, 3-wire · Wiring diagram no. 1									
	5 m orange PVC cable	3 x 0.34 mm ² , Ø 4.9 mm	PVC / stainless steel 316L / 1.4404	50 AC 60 DC	-25...80	IP 65 / IP 67 / IP 68 / IP 69K	-	42	EVT123
	10 m orange PVC cable	3 x 0.34 mm ² , Ø 4.9 mm	PVC / stainless steel 316L / 1.4404	50 AC 60 DC	-25...80	IP 65 / IP 67 / IP 68 / IP 69K	-	42	EVT124
	25 m orange PVC cable	3 x 0.34 mm ² , Ø 4.9 mm	PVC / stainless steel 316L / 1.4404	50 AC 60 DC	-25...80	IP 65 / IP 67 / IP 68 / IP 69K	-	42	EVT125
	2 m orange PVC cable	3 x 0.34 mm ² , Ø 4.9 mm	PVC / stainless steel 316L / 1.4404	50 AC 60 DC	-25...80	IP 65 / IP 67 / IP 68 / IP 69K	-	44	EVT126
	5 m orange PVC cable	3 x 0.34 mm ² , Ø 4.9 mm	PVC / stainless steel 316L / 1.4404	50 AC 60 DC	-25...80	IP 65 / IP 67 / IP 68 / IP 69K	-	44	EVT127
	10 m orange PVC cable	3 x 0.34 mm ² , Ø 4.9 mm	PVC / stainless steel 316L / 1.4404	50 AC 60 DC	-25...80	IP 65 / IP 67 / IP 68 / IP 69K	-	44	EVT128
	25 m orange PVC cable	3 x 0.34 mm ² , Ø 4.9 mm	PVC / stainless steel 316L / 1.4404	50 AC 60 DC	-25...80	IP 65 / IP 67 / IP 68 / IP 69K	-	44	EVT129
Group 122 · Socket M8, 3-pole, 3-wire, LED, PNP · Wiring diagram no. 2									
	2 m orange PVC cable	3 x 0.34 mm ² , Ø 4.9 mm	PVC / stainless steel 316L / 1.4404	10...36 DC	-25...80	IP 65 / IP 67 / IP 68 / IP 69K	green / yellow	45	EVT130
	5 m orange PVC cable	3 x 0.34 mm ² , Ø 4.9 mm	PVC / stainless steel 316L / 1.4404	10...36 DC	-25...80	IP 65 / IP 67 / IP 68 / IP 69K	green / yellow	45	EVT131
	10 m orange PVC cable	3 x 0.34 mm ² , Ø 4.9 mm	PVC / stainless steel 316L / 1.4404	10...36 DC	-25...80	IP 65 / IP 67 / IP 68 / IP 69K	green / yellow	45	EVT132
	25 m orange PVC cable	3 x 0.34 mm ² , Ø 4.9 mm	PVC / stainless steel 316L / 1.4404	10...36 DC	-25...80	IP 65 / IP 67 / IP 68 / IP 69K	green / yellow	45	EVT133
Group 124 · Socket M8, 4-pole, 4-wire · Wiring diagram no. 4									
	2 m orange PVC cable	4 x 0.34 mm ² , Ø 4.9 mm	PVC / stainless steel 316L / 1.4404	50 AC 60 DC	-25...80	IP 65 / IP 67 / IP 68 / IP 69K	-	46	EVT134
	5 m orange PVC cable	4 x 0.34 mm ² , Ø 4.9 mm	PVC / stainless steel 316L / 1.4404	50 AC 60 DC	-25...80	IP 65 / IP 67 / IP 68 / IP 69K	-	46	EVT135
	10 m orange PVC cable	4 x 0.34 mm ² , Ø 4.9 mm	PVC / stainless steel 316L / 1.4404	50 AC 60 DC	-25...80	IP 65 / IP 67 / IP 68 / IP 69K	-	46	EVT136

Type	Cable	Wire specification	Material housing / nut	U [V]	T _a [°C]	Protection	LEDs	Drawing no.	Order no.
Group 124 · Socket M8, 4-pole, 4-wire · Wiring diagram no. 4									
	25 m orange PVC cable	4 x 0.34 mm ² , Ø 4.9 mm	PVC / stainless steel 316L / 1.4404	50 AC 60 DC	-25...80	IP 65 / IP 67 / IP 68 / IP 69K	-	46	EVT137
	2 m orange PVC cable	4 x 0.34 mm ² , Ø 4.9 mm	PVC / stainless steel 316L / 1.4404	50 AC 60 DC	-25...80	IP 65 / IP 67 / IP 68 / IP 69K	-	47	EVT138
	5 m orange PVC cable	4 x 0.34 mm ² , Ø 4.9 mm	PVC / stainless steel 316L / 1.4404	50 AC 60 DC	-25...80	IP 65 / IP 67 / IP 68 / IP 69K	-	47	EVT139
	10 m orange PVC cable	4 x 0.34 mm ² , Ø 4.9 mm	PVC / stainless steel 316L / 1.4404	50 AC 60 DC	-25...80	IP 65 / IP 67 / IP 68 / IP 69K	-	47	EVT140
	25 m orange PVC cable	4 x 0.34 mm ² , Ø 4.9 mm	PVC / stainless steel 316L / 1.4404	50 AC 60 DC	-25...80	IP 65 / IP 67 / IP 68 / IP 69K	-	47	EVT141
Group 126 · Socket M12, 5/4-pole, 4-wire · Wiring diagram no. 4									
	2 m orange PVC cable	4 x 0.34 mm ² , Ø 4.9 mm	PVC / stainless steel 316L / 1.4404	250 AC 300 DC	-25...100	IP 65 / IP 67 / IP 68 / IP 69K	-	43	EVT067
	5 m orange PVC cable	4 x 0.34 mm ² , Ø 4.9 mm	PVC / stainless steel 316L / 1.4404	250 AC 300 DC	-25...100	IP 65 / IP 67 / IP 68 / IP 69K	-	43	EVT004
	10 m orange PVC cable	4 x 0.34 mm ² , Ø 4.9 mm	PVC / stainless steel 316L / 1.4404	250 AC 300 DC	-25...100	IP 65 / IP 67 / IP 68 / IP 69K	-	43	EVT005
	25 m orange PVC cable	4 x 0.34 mm ² , Ø 4.9 mm	PVC / stainless steel 316L / 1.4404	250 AC 300 DC	-25...100	IP 65 / IP 67 / IP 68 / IP 69K	-	43	EVT006
	2 m orange PVC cable	4 x 0.34 mm ² , Ø 4.9 mm	PVC / stainless steel 316L / 1.4404	250 AC 300 DC	-25...100	IP 65 / IP 67 / IP 68 / IP 69K	-	41	EVT064
	5 m orange PVC cable	4 x 0.34 mm ² , Ø 4.9 mm	PVC / stainless steel 316L / 1.4404	250 AC 300 DC	-25...100	IP 65 / IP 67 / IP 68 / IP 69K	-	41	EVT001
	10 m orange PVC cable	4 x 0.34 mm ² , Ø 4.9 mm	PVC / stainless steel 316L / 1.4404	250 AC 300 DC	-25...100	IP 65 / IP 67 / IP 68 / IP 69K	-	41	EVT002
	25 m orange PVC cable	4 x 0.34 mm ² , Ø 4.9 mm	PVC / stainless steel 316L / 1.4404	250 AC 300 DC	-25...100	IP 65 / IP 67 / IP 68 / IP 69K	-	41	EVT003
Group 128 · Wirable socket M12, 4-pole · Wiring diagram no. 5									
	wirable	...0.75 mm ² (Ø 4...6 mm)	PA / high-grade st. steel	240 AC/DC	-25...85	IP 67	-	48	E11862



Type	Cable	Wire specification	Material housing / nut	U [V]	T _a [°C]	Protection	LEDs	Drawing no.	Order no.
Group 128 · Wirable socket M12, 4-pole · Wiring diagram no. 5									
	wirable	...0.75 mm ² (Ø 4...6 mm)	PA / high-grade st. steel	240 AC/DC	-25...90	IP 67	–	49	E11861
Group 130 · Socket M12, 5/4-pole, 4-wire, LED, PNP · Wiring diagram no. 9									
	2 m orange PVC cable	4 x 0.34 mm ² , Ø 4.9 mm	PVC / stainless steel 316L / 1.4404	10...36 DC	-25...100	IP 65 / IP 67 / IP 68 / IP 69K	green / 2 x yellow	50	EVT069
	5 m orange PVC cable	4 x 0.34 mm ² , Ø 4.9 mm	PVC / stainless steel 316L / 1.4404	10...36 DC	-25...100	IP 65 / IP 67 / IP 68 / IP 69K	green / 2 x yellow	50	EVT007
	10 m orange PVC cable	4 x 0.34 mm ² , Ø 4.9 mm	PVC / stainless steel 316L / 1.4404	10...36 DC	-25...100	IP 65 / IP 67 / IP 68 / IP 69K	green / 2 x yellow	50	EVT008
	25 m orange PVC cable	4 x 0.34 mm ² , Ø 4.9 mm	PVC / stainless steel 316L / 1.4404	10...36 DC	-25...100	IP 65 / IP 67 / IP 68 / IP 69K	green / 2 x yellow	50	EVT009
Group 131 · Wirable socket M12, 5/4-pole, LED, PNP · Wiring diagram no. 27									
	wirable	...0.75 mm ² (Ø 4...6 mm)	PBT / high-grade st. steel	10...30 DC	-25...85	IP 67 / IP 69K	green / yellow	53	E11863
Group 132 · Socket M12, 5-pole, 5-wire · Wiring diagram no. 11									
	5 m orange PVC cable	5 x 0.34 mm ² , Ø 5.1 mm	PVC / stainless steel 316L / 1.4404	60 AC 60 DC	-25...100	IP 65 / IP 67 / IP 68 / IP 69K	–	43	EVT013
	10 m orange PVC cable	5 x 0.34 mm ² , Ø 5.1 mm	PVC / stainless steel 316L / 1.4404	60 AC 60 DC	-25...100	IP 65 / IP 67 / IP 68 / IP 69K	–	43	EVT014
	25 m orange PVC cable	5 x 0.34 mm ² , Ø 5.1 mm	PVC / stainless steel 316L / 1.4404	60 AC 60 DC	-25...100	IP 65 / IP 67 / IP 68 / IP 69K	–	43	EVT015
	5 m orange PVC cable	5 x 0.34 mm ² , Ø 5.1 mm	PVC / stainless steel 316L / 1.4404	60 AC 60 DC	-25...100	IP 65 / IP 67 / IP 68 / IP 69K	–	41	EVT010
	10 m orange PVC cable	5 x 0.34 mm ² , Ø 5.1 mm	PVC / stainless steel 316L / 1.4404	60 AC 60 DC	-25...100	IP 65 / IP 67 / IP 68 / IP 69K	–	41	EVT011
	25 m orange PVC cable	5 x 0.34 mm ² , Ø 5.1 mm	PVC / stainless steel 316L / 1.4404	60 AC 60 DC	-25...100	IP 65 / IP 67 / IP 68 / IP 69K	–	41	EVT012

Connectors for hazardous areas





Type	Cable	Wire specification	Material housing / nut	U [V]	T _a [°C]	Protection	LEDs	Drawing no.	Order no.
Group 153 · Socket M12, 5/4 poles, 4 wires, cat. 1D / 1G · Wiring diagram no. 4									
	2 m blue PUR cable	4 x 0.34 mm ² , Ø 4.9 mm	TPU / Brass	...30 DC	-25...90	IP 67	–	6	ENC04A
	5 m blue PUR cable	4 x 0.34 mm ² , Ø 4.9 mm	TPU / Brass	...30 DC	-25...90	IP 67	–	6	ENC05A
	10 m blue PUR cable	4 x 0.34 mm ² , Ø 4.9 mm	TPU / Brass	...30 DC	-25...90	IP 67	–	6	ENC06A
	2 m blue PUR cable	4 x 0.34 mm ² , Ø 4.9 mm	TPU / Brass	...30 DC	-25...90	IP 67	–	7	ENC01A
	5 m blue PUR cable	4 x 0.34 mm ² , Ø 4.9 mm	TPU / Brass	...30 DC	-25...90	IP 67	–	7	ENC02A
	10 m blue PUR cable	4 x 0.34 mm ² , Ø 4.9 mm	TPU / Brass	...30 DC	-25...90	IP 67	–	7	ENC03A
Group 154 · Socket M12, 5/4 poles, 4 wires, cat. 2D / 3G · Wiring diagram no. 4									
	2 m black PUR cable	4 x 0.34 mm ² , Ø 4.9 mm	TPU / stainless steel 316L / 1.4404	60 AC 60 DC	-20...60	IP 67	–	54	EVC04A
	5 m black PUR cable	4 x 0.34 mm ² , Ø 4.9 mm	TPU / stainless steel 316L / 1.4404	60 AC 60 DC	-20...60	IP 67	–	54	EVC05A
	10 m black PUR cable	4 x 0.34 mm ² , Ø 4.9 mm	TPU / stainless steel 316L / 1.4404	60 AC 60 DC	-20...60	IP 67	–	54	EVC06A
	25 m black PUR cable	4 x 0.34 mm ² , Ø 4.9 mm	TPU / stainless steel 316L / 1.4404	60 AC 60 DC	-20...60	IP 67	–	54	EVC14A
Group 155 · socket M12, 5 poles, 5 wires, cat. 1D / 1G · Wiring diagram no. 11									
	2 m blue PUR cable	5 x 0.34 mm ² , Ø 4.9 mm	TPU / Brass	...30 DC	-25...90	IP 67	–	6	ENC10A
	5 m blue PUR cable	5 x 0.34 mm ² , Ø 4.9 mm	TPU / Brass	...30 DC	-25...90	IP 67	–	6	ENC11A
	10 m blue PUR cable	5 x 0.34 mm ² , Ø 4.9 mm	TPU / Brass	...30 DC	-25...90	IP 67	–	6	ENC12A

Type	Cable	Wire specification	Material housing / nut	U [V]	T _a [°C]	Protection	LEDs	Drawing no.	Order no.
Group 155 · socket M12, 5 poles, 5 wires, cat. 1D / 1G · Wiring diagram no. 11									
	25 m blue PUR cable	5 x 0.34 mm ² , Ø 4.9 mm	TPU / Brass	...30 DC	-25...90	IP 67	–	6	ENC13A
	50 m blue PUR cable	5 x 0.34 mm ² , Ø 4.9 mm	TPU / Brass	...30 DC	-25...90	IP 67	–	6	ENC14A
	2 m blue PUR cable	5 x 0.34 mm ² , Ø 4.9 mm	TPU / Brass	...30 DC	-25...90	IP 67	–	7	ENC07A
	5 m blue PUR cable	5 x 0.34 mm ² , Ø 4.9 mm	TPU / Brass	...30 DC	-25...90	IP 67	–	7	ENC08A
	10 m blue PUR cable	5 x 0.34 mm ² , Ø 4.9 mm	TPU / Brass	...30 DC	-25...90	IP 67	–	7	ENC09A

Connectors for robust applications

Type	Cable	Wire specification	Material housing / nut	U [V]	T _a [°C]	Protection	LEDs	Drawing no.	Order no.
Group 157 · Socket M12, 5/4-pole, 4-wire · Wiring diagram no. 4									
	2 m black PUR cable	4 x 0.34 mm ² , Ø 4.9 mm	TPU / stainless steel 316L / 1.4404	250 AC 300 DC	-40...90	IP 65 / IP 67 / IP 68 / IP 69K	–	54	EVM004
	5 m black PUR cable	4 x 0.34 mm ² , Ø 4.9 mm	TPU / stainless steel 316L / 1.4404	250 AC 300 DC	-40...90	IP 65 / IP 67 / IP 68 / IP 69K	–	54	EVM005
	10 m black PUR cable	4 x 0.34 mm ² , Ø 4.9 mm	TPU / stainless steel 316L / 1.4404	250 AC 300 DC	-40...90	IP 65 / IP 67 / IP 68 / IP 69K	–	54	EVM006
	25 m black PUR cable	4 x 0.34 mm ² , Ø 4.9 mm	TPU / stainless steel 316L / 1.4404	250 AC 300 DC	-40...90	IP 65 / IP 67 / IP 68 / IP 69K	–	54	EVM012
	50 m black PUR cable	4 x 0.34 mm ² , Ø 4.9 mm	TPU / stainless steel 316L / 1.4404	250 AC 300 DC	-40...90	IP 65 / IP 67 / IP 68 / IP 69K	–	54	EVM010
	2 m black PUR cable	4 x 0.34 mm ² , Ø 4.9 mm	TPU / stainless steel 316L / 1.4404	250 AC 300 DC	-40...90	IP 65 / IP 67 / IP 68 / IP 69K	–	55	EVM001
	5 m black PUR cable	4 x 0.34 mm ² , Ø 4.9 mm	TPU / stainless steel 316L / 1.4404	250 AC 300 DC	-40...90	IP 65 / IP 67 / IP 68 / IP 69K	–	55	EVM002
	10 m black PUR cable	4 x 0.34 mm ² , Ø 4.9 mm	TPU / stainless steel 316L / 1.4404	250 AC 300 DC	-40...90	IP 65 / IP 67 / IP 68 / IP 69K	–	55	EVM003

You can find wiring diagrams and scale drawings from page 759

Type	Cable	Wire specification	Material housing / nut	U [V]	T _a [°C]	Protection	LEDs	Drawing no.	Order no.
Group 157 · Socket M12, 5/4-pole, 4-wire · Wiring diagram no. 4									
	25 m black PUR cable	4 x 0.34 mm ² , Ø 4.9 mm	TPU / stainless steel 316L / 1.4404	250 AC 300 DC	-40...90	IP 65 / IP 67 / IP 68 / IP 69K	-	55	EVM014
Group 158 · Socket M12, 5/4-pole, 4-wire, LED, PNP · Wiring diagram no. 9									
	2 m black PUR cable	4 x 0.34 mm ² , Ø 4.9 mm	TPU / stainless steel 316L / 1.4404	10...36 DC	-40...90	IP 65 / IP 67 / IP 68 / IP 69K	green / 2 x yellow	56	EVM007
	5 m black PUR cable	4 x 0.34 mm ² , Ø 4.9 mm	TPU / stainless steel 316L / 1.4404	10...36 DC	-40...90	IP 65 / IP 67 / IP 68 / IP 69K	green / 2 x yellow	56	EVM008
	10 m black PUR cable	4 x 0.34 mm ² , Ø 4.9 mm	TPU / stainless steel 316L / 1.4404	10...36 DC	-40...90	IP 65 / IP 67 / IP 68 / IP 69K	green / 2 x yellow	56	EVM009
Group 159 · Socket M12, 5-pole, 5-wire · Wiring diagram no. 11									
	2 m black PUR cable	5 x 0.34 mm ² , Ø 4.9 mm	TPU / stainless steel 316L / 1.4404	50 AC 60 DC	-40...90	IP 65 / IP 67 / IP 68 / IP 69K	-	54	EVM039
	5 m black PUR cable	5 x 0.34 mm ² , Ø 4.9 mm	TPU / stainless steel 316L / 1.4404	50 AC 60 DC	-40...90	IP 65 / IP 67 / IP 68 / IP 69K	-	54	EVM040
	10 m black PUR cable	5 x 0.34 mm ² , Ø 4.9 mm	TPU / stainless steel 316L / 1.4404	50 AC 60 DC	-40...90	IP 65 / IP 67 / IP 68 / IP 69K	-	54	EVM041
	2 m black PUR cable	5 x 0.34 mm ² , Ø 4.9 mm	TPU / stainless steel 316L / 1.4404	60 AC 60 DC	-40...90	IP 65 / IP 67 / IP 68 / IP 69K	-	55	EVM036
	5 m black PUR cable	5 x 0.34 mm ² , Ø 4.9 mm	TPU / stainless steel 316L / 1.4404	60 AC 60 DC	-40...90	IP 65 / IP 67 / IP 68 / IP 69K	-	55	EVM037
	10 m black PUR cable	5 x 0.34 mm ² , Ø 4.9 mm	TPU / stainless steel 316L / 1.4404	60 AC 60 DC	-40...90	IP 65 / IP 67 / IP 68 / IP 69K	-	55	EVM038
	2 m black PUR cable	5 x 0.34 mm ² , Ø 4.9 mm	TPU / stainless steel 316L / 1.4404	50 AC 60 DC	-40...90	IP 65 / IP 67 / IP 68 / IP 69K	-	54	EVM039
	5 m black PUR cable	5 x 0.34 mm ² , Ø 4.9 mm	TPU / stainless steel 316L / 1.4404	50 AC 60 DC	-40...90	IP 65 / IP 67 / IP 68 / IP 69K	-	54	EVM040
	10 m black PUR cable	5 x 0.34 mm ² , Ø 4.9 mm	TPU / stainless steel 316L / 1.4404	50 AC 60 DC	-40...90	IP 65 / IP 67 / IP 68 / IP 69K	-	54	EVM041

Wiring diagrams

Core colours

- BK black
- BN brown
- BU blue
- WH white
- GN/YE green/yellow
- GY grey
- GN green
- YE yellow
- PK pink
- screen Screen
- OG orange
- VT lilac
- RD red
- RD/BK red/black
- RD/WH red/white

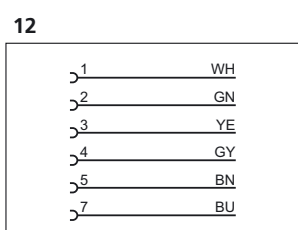
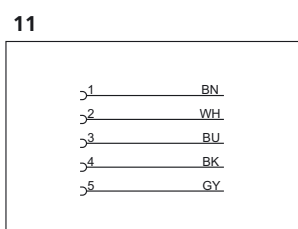
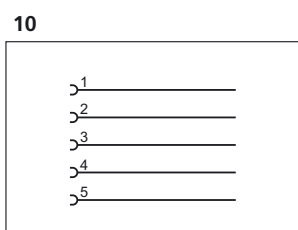
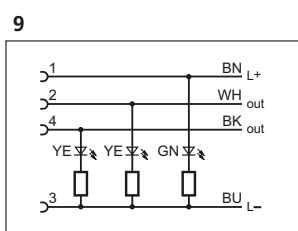
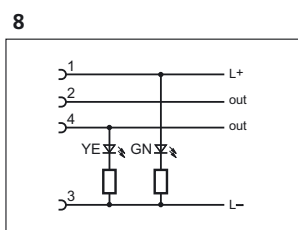
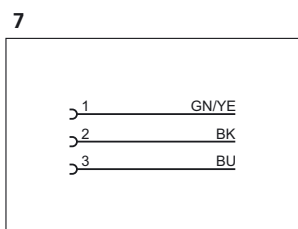
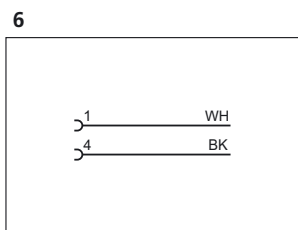
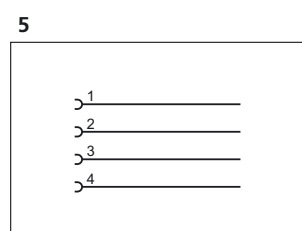
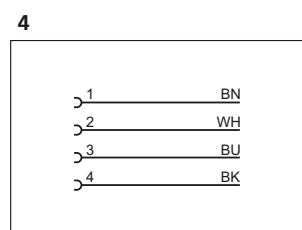
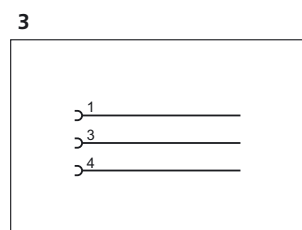
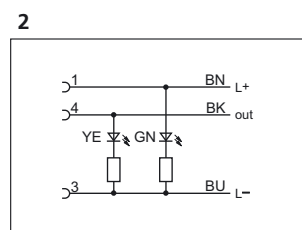
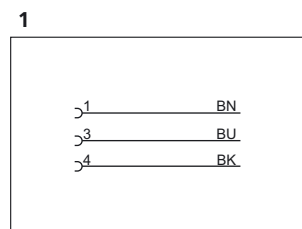

6: not used

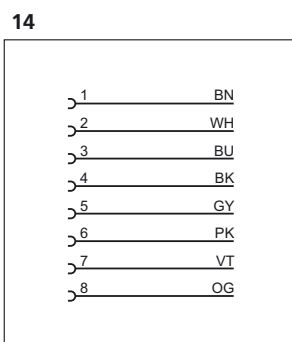
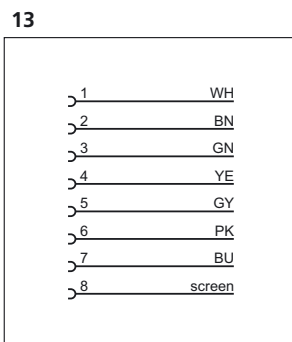

Colours to DIN EN 60947-5-6

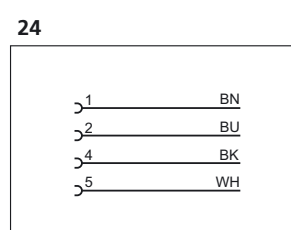
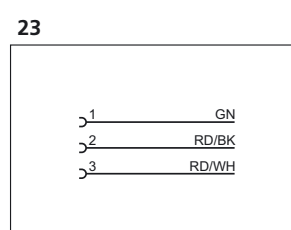
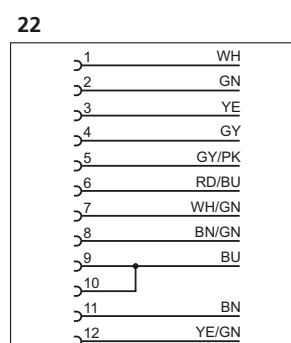
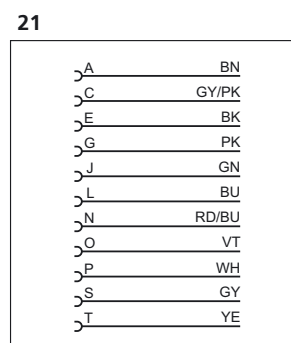
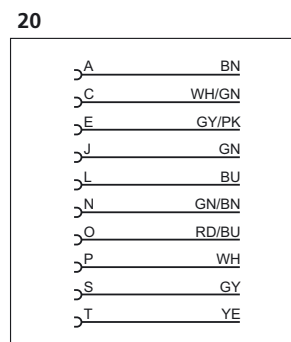
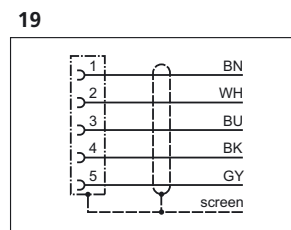
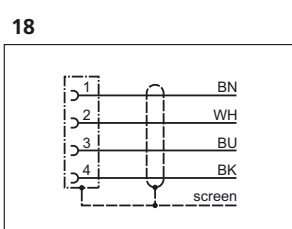
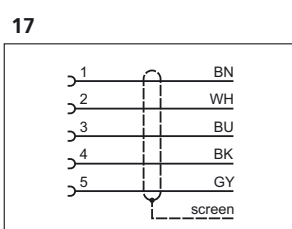
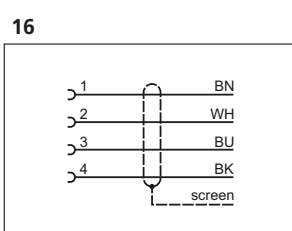
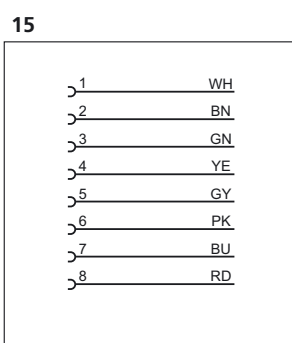

Wiring diagrams

25

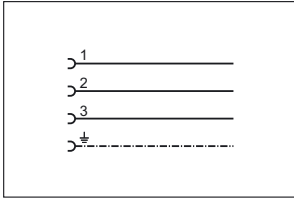

26

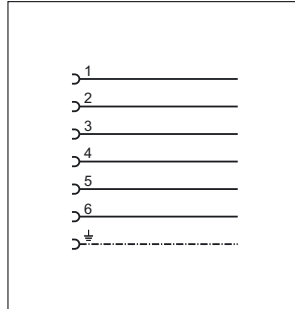

27

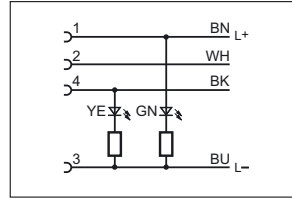

28

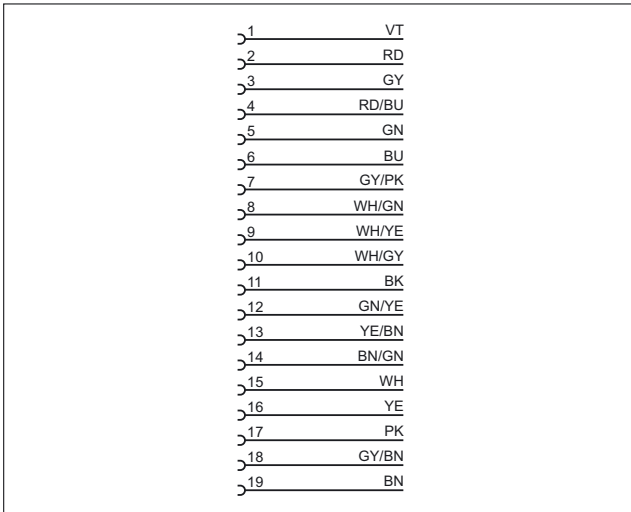

Scale drawings / drawing no. – CAD download: www.ifm.com

1

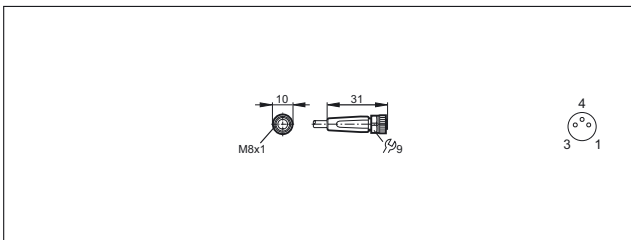

4

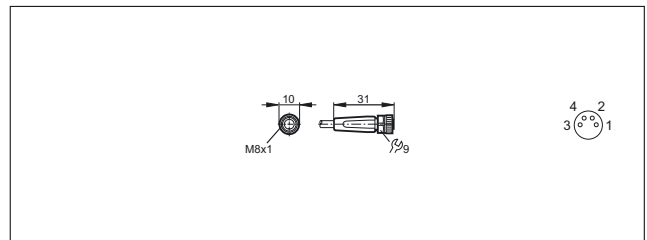

2

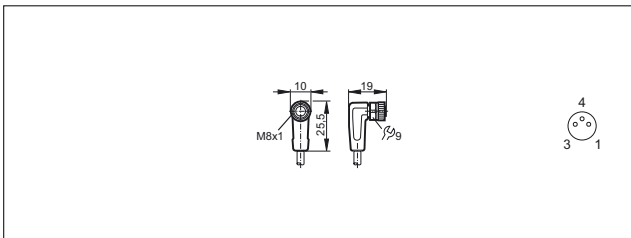

5

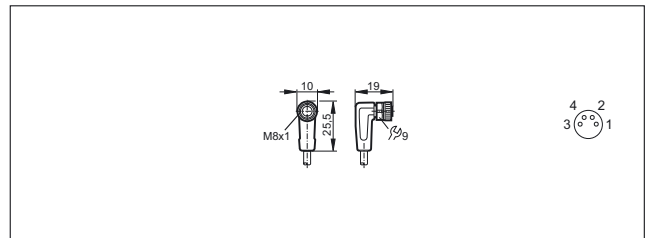

3

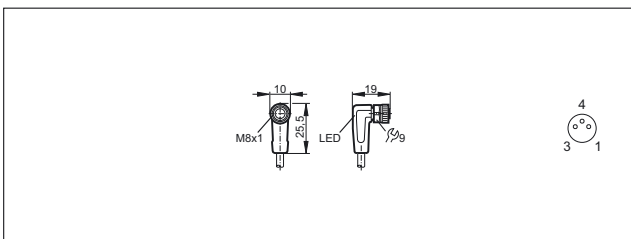

6

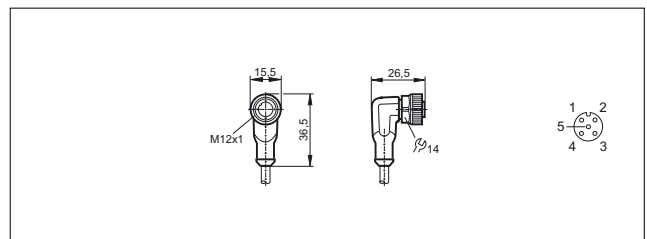

Scale drawings / drawing no. – CAD download: www.ifm.com

7

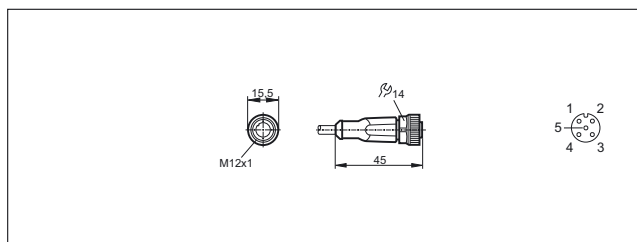

13

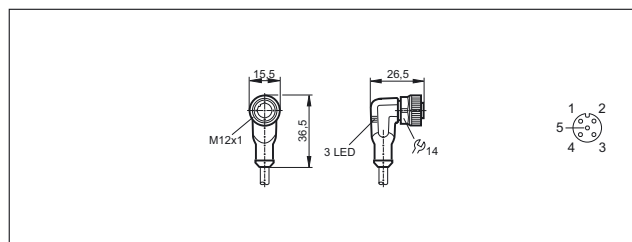

8

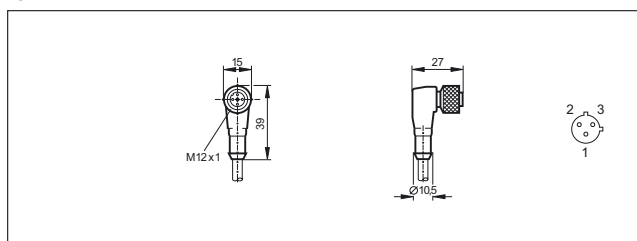

14

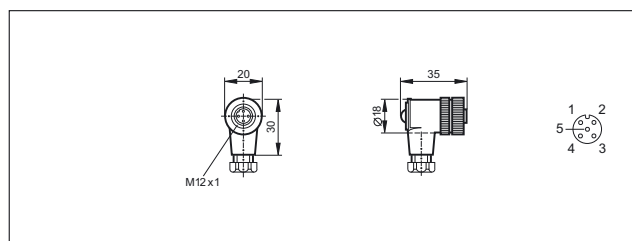

9

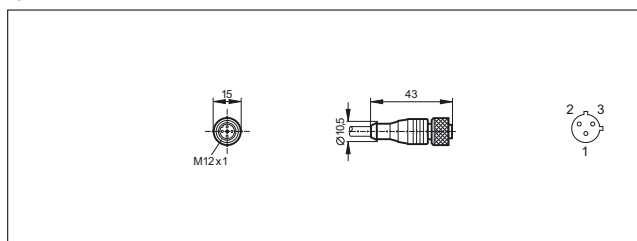

15

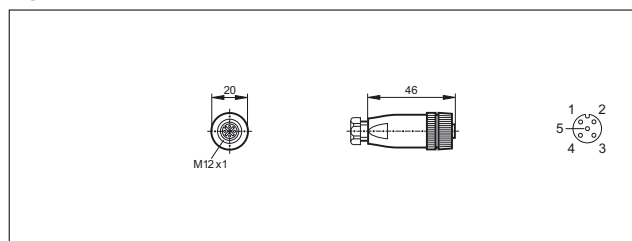

10

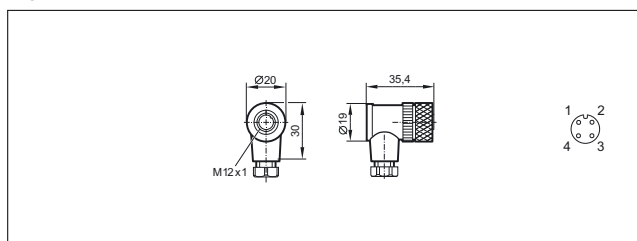

16

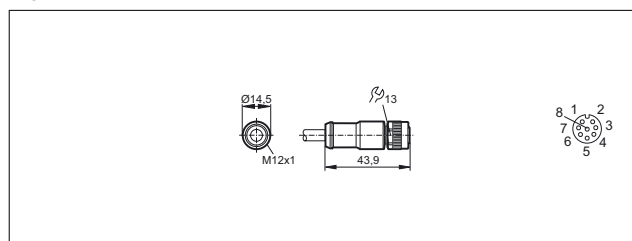

11

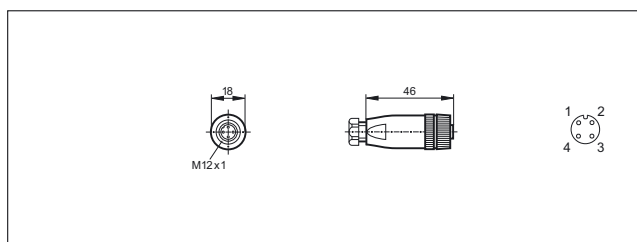

17

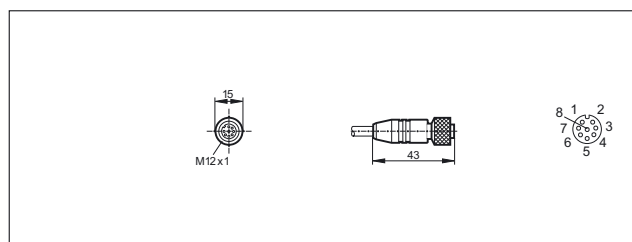

12

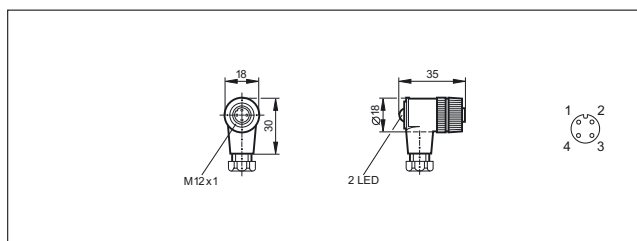

18

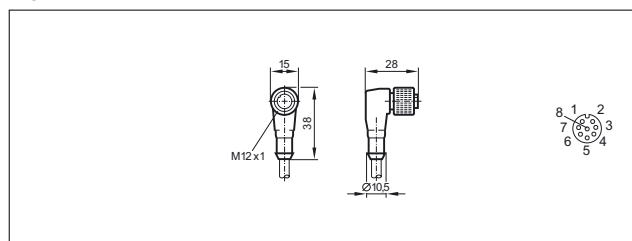

Scale drawings / drawing no. – CAD download: www.ifm.com

19

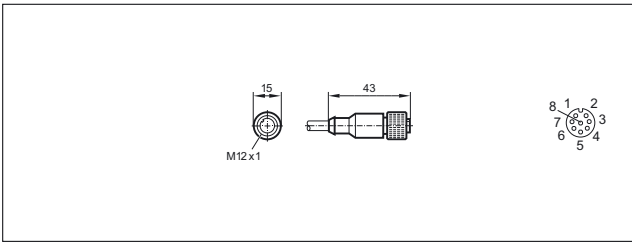

25

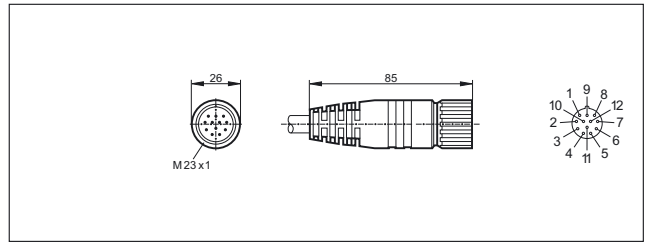

20

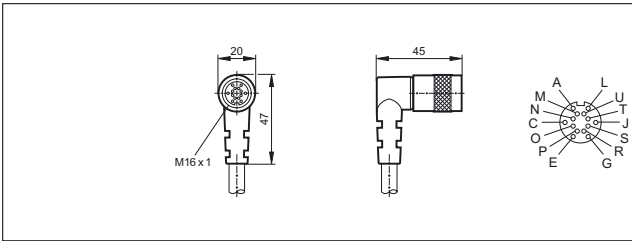

26

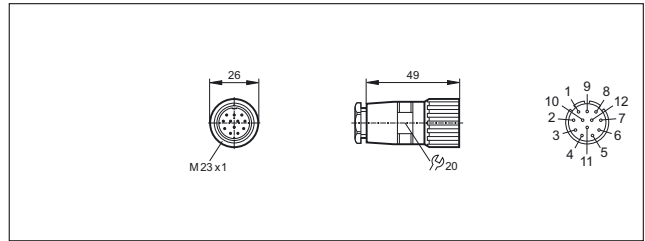

21

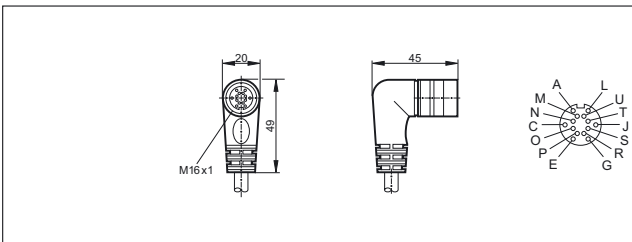

27

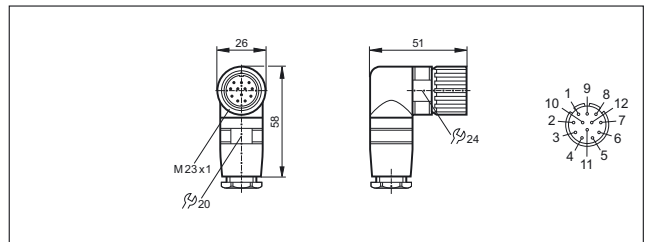

22

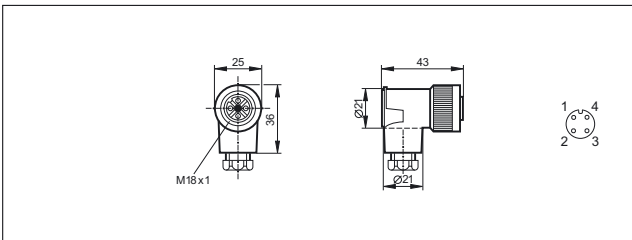

28

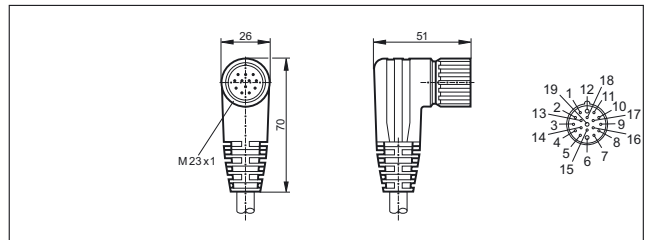

23

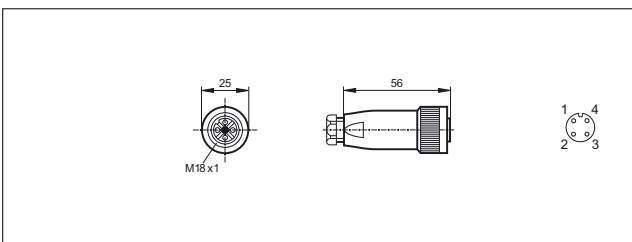

29

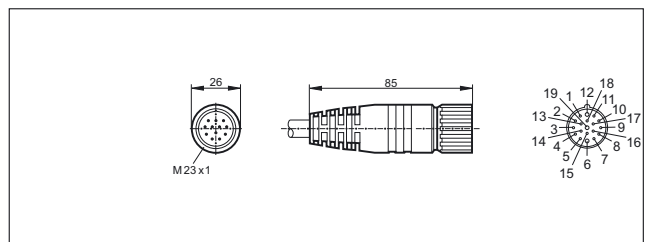

24

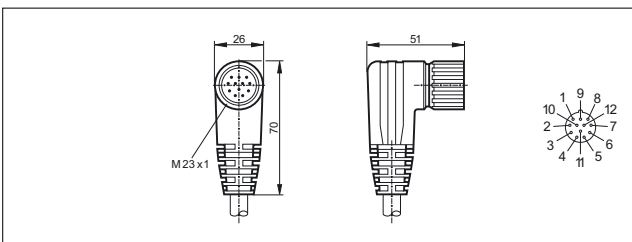

30

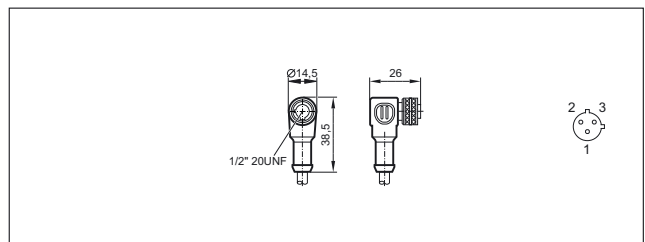

Scale drawings / drawing no. – CAD download: www.ifm.com

31

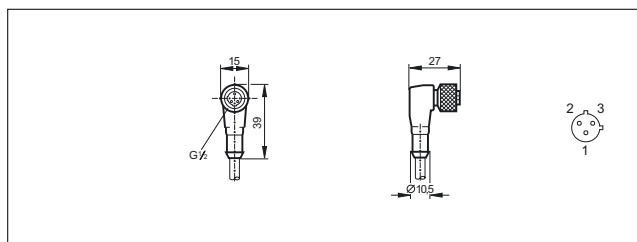

37

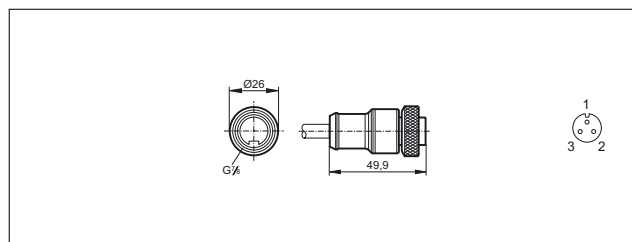

32

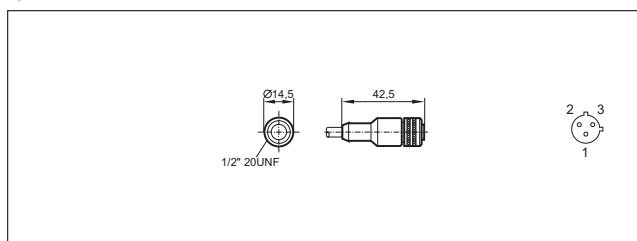

38

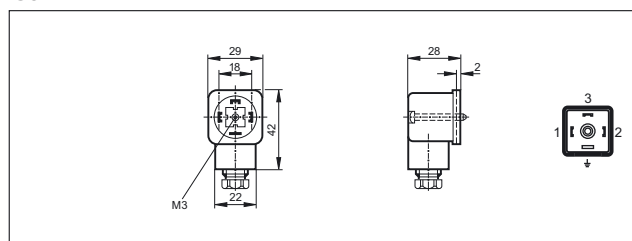

33

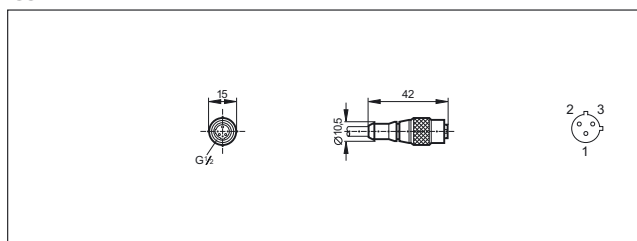

39

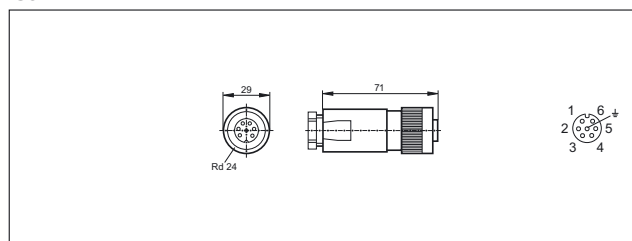

34

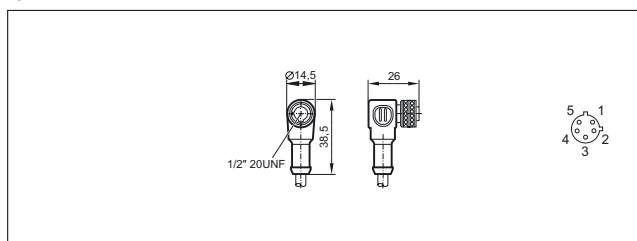

40

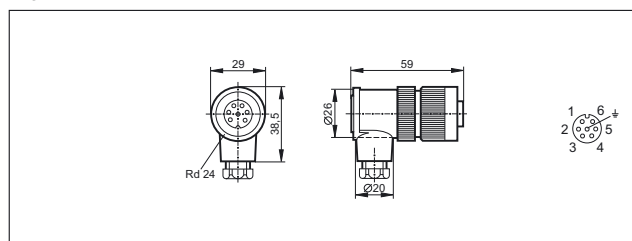

35

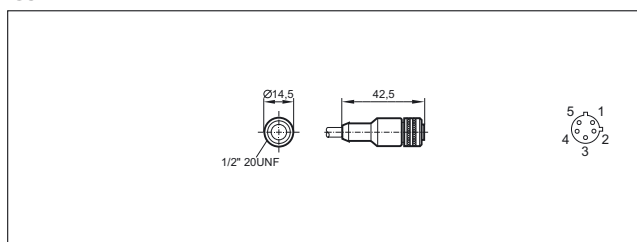

41

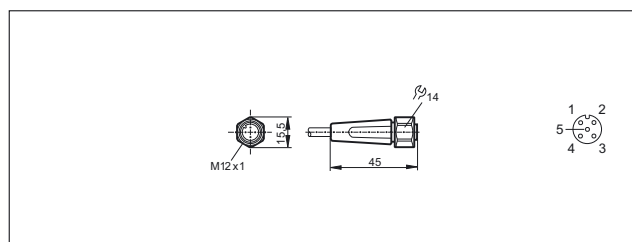

36

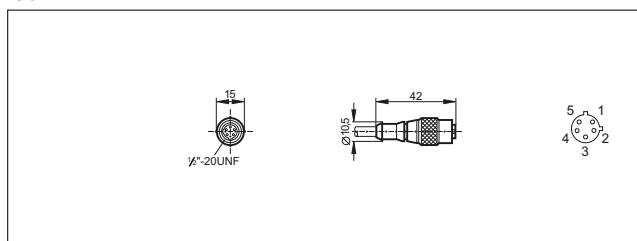

42

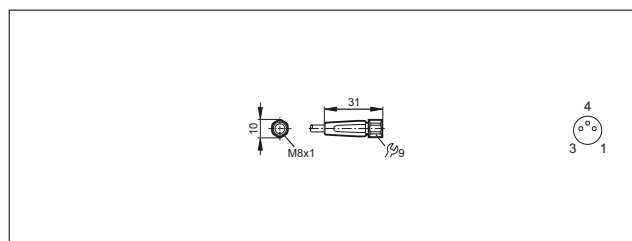

Scale drawings / drawing no. – CAD download: www.ifm.com

43

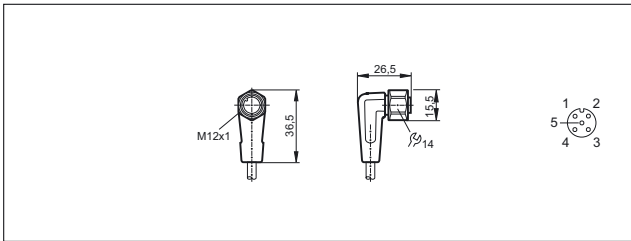

49

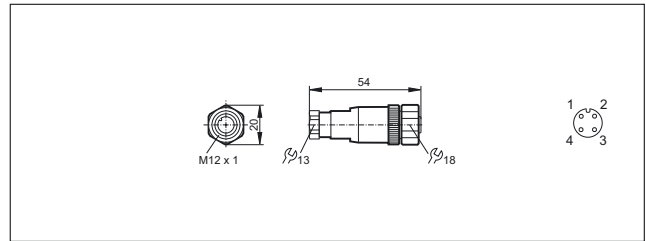

44

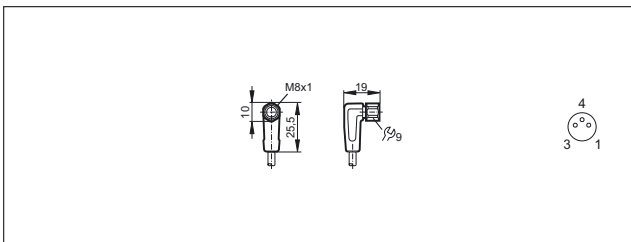

50

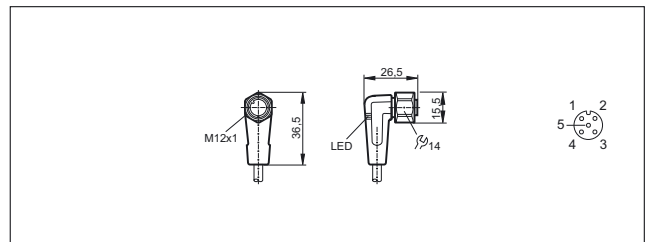

45

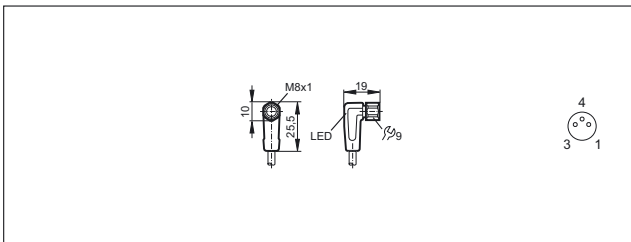

51

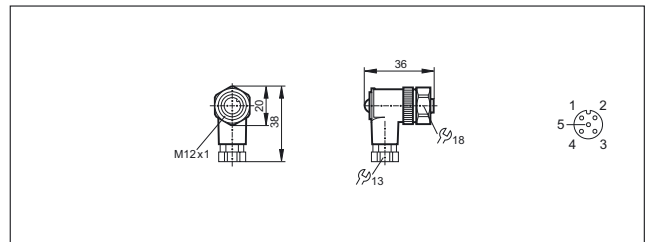

46

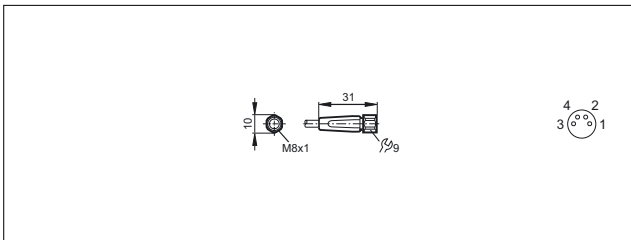

52

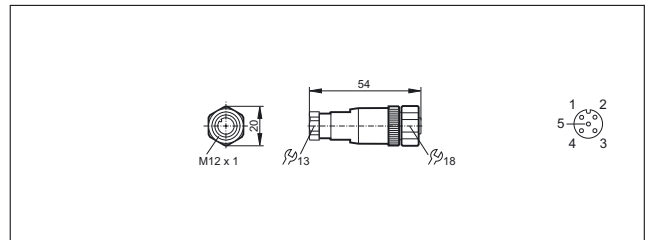

47

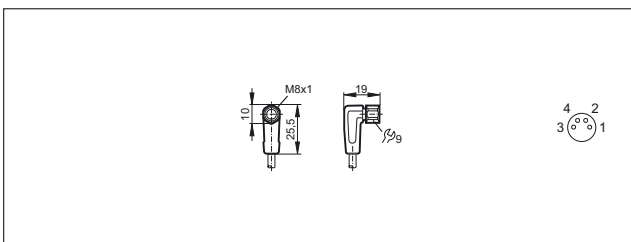

53

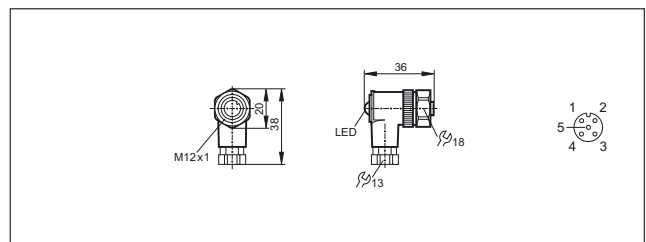

48

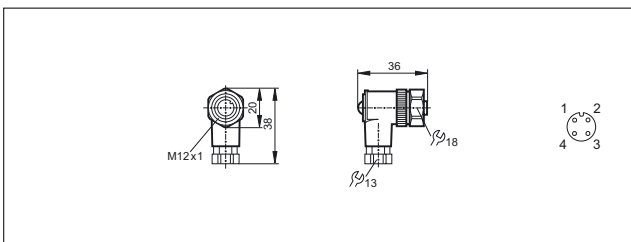

54

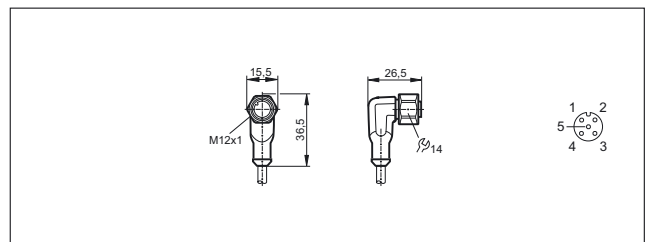

Scale drawings / drawing no. – CAD download: www.ifm.com

55

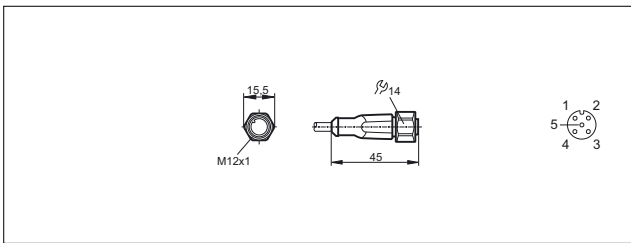

56

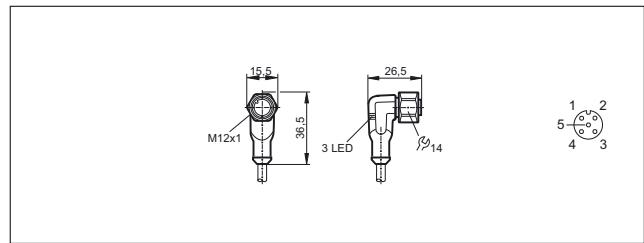





Plugs

Plugs are mainly used for the connection to splitter boxes and modules. High-quality pin contacts and materials ensure reliable electrical connections.

In addition to a wide range of standard products ifm also offers versions without silicone and halogen, versions for hygienic areas, for applications in contact with coolants and lubricants, as well as for welding applications.

System overview	Page
M8 cable plugs for industrial applications	766
M12 cable plugs for industrial applications	766 - 767
Connectors for hygienic and wet areas	767 - 768
Wiring diagrams	768
Scale drawings / drawing no. – CAD download: www.ifm.com	769 - 770

M8 cable plugs for industrial applications

Type	Cable	Wire specification	Material housing / nut	U [V]	T _a [°C]	Protection	LEDs	Drawing no.	Order no.
Group 35 · Wirable plug M8, 3-pole · Wiring diagram no. 1									
	wirable	–	PA / Brass	60 AC 75 DC	-25...90	IP 68	–	–	E11550
Group 36 · Wirable plug M8, 4-pole · Wiring diagram no. 2									
	wirable	–	PA / Brass	60 AC 75 DC	-25...90	IP 68	–	–	E11551

M12 cable plugs for industrial applications



Type	Cable	Wire specification	Material housing / nut	U [V]	T _a [°C]	Protection	LEDs	Drawing no.	Order no.
Group 37 · Cable plug M12, 4-pole, 4-wire · Wiring diagram no. 3									
	2 m black PUR cable	4 x 0.34 mm ² , Ø 4.9 mm	TPU / Brass	250 AC 300 DC	-25...90	IP 65 / IP 67 / IP 68 / IP 69K	–	1	EVC079
	5 m black PUR cable	4 x 0.34 mm ² , Ø 4.9 mm	TPU / Brass	250 AC 300 DC	-25...90	IP 65 / IP 67 / IP 68 / IP 69K	–	1	EVC080

Type	Cable	Wire specification	Material housing / nut	U [V]	T _a [°C]	Protection	LEDs	Drawing no.	Order no.
------	-------	--------------------	------------------------	-------	---------------------	------------	------	-------------	-----------



Group 37 · Cable plug M12, 4-pole, 4-wire · Wiring diagram no. 3

	10 m black PUR cable	4 x 0.34 mm ² , Ø 4.9 mm	TPU / Brass	250 AC 300 DC	-25...90	IP 65 / IP 67 / IP 68 / IP 69K	–	1	EVC081
	2 m black PUR cable	4 x 0.34 mm ² , Ø 4.9 mm	TPU / Brass	250 AC 300 DC	-25...90	IP 65 / IP 67 / IP 68 / IP 69K	–	2	EVC076
	5 m black PUR cable	4 x 0.34 mm ² , Ø 4.9 mm	TPU / Brass	250 AC 300 DC	-25...90	IP 65 / IP 67 / IP 68 / IP 69K	–	2	EVC077
	10 m black PUR cable	4 x 0.34 mm ² , Ø 4.9 mm	TPU / Brass	250 AC 300 DC	-25...90	IP 65 / IP 67 / IP 68 / IP 69K	–	2	EVC078



Group 38 · Wirable plug M12, 4-pole · Wiring diagram no. 2

	wirable	...0.75 mm ² (Ø 4...6 mm)	PA / Brass	250 AC/DC	-25...85	IP 68	–	3	E11505
	wirable	...0.75 mm ² (Ø 4...6 mm)	PA / Brass	250 AC/DC	-25...85	IP 68	–	4	E11504

Group 39 · Cable plug M12, 5-pole, 5-wire · Wiring diagram no. 4

	2 m black PUR cable	5 x 0.34 mm ² , Ø 4.9 mm	TPU / Brass	60 AC 60 DC	-25...90	IP 65 / IP 67 / IP 68 / IP 69K	–	5	EVC095
	2 m black PUR cable	5 x 0.34 mm ² , Ø 4.9 mm	TPU / Brass	60 AC 60 DC	-25...90	IP 65 / IP 67 / IP 68 / IP 69K	–	6	EVC094

Group 40 · Wirable plug M12, 5-pole · Wiring diagram no. 5

	wirable	...0.75 mm ² (Ø 4...6 mm)	PA / Brass	125 AC/DC	-25...85	IP 68	–	7	E11507
	wirable	...0.75 mm ² (Ø 4...6 mm)	PA / Brass	125 AC/DC	-25...85	IP 68	–	8	E11506







Connectors for hygienic and wet areas

Type	Cable	Wire specification	Material housing / nut	U [V]	T _a [°C]	Protection	LEDs	Drawing no.	Order no.
------	-------	--------------------	------------------------	-------	---------------------	------------	------	-------------	-----------

Group 133 · Cable plug M12, 4-pole, 4-wire · Wiring diagram no. 3

	2 m orange PVC cable	4 x 0.34 mm ² , Ø 4.9 mm	PVC / stainless steel 316L / 1.4404	250 AC 300 DC	-25...100	IP 65 / IP 67 / IP 68 / IP 69K	–	9	EVT071
---	----------------------	-------------------------------------	--	------------------	-----------	-----------------------------------	---	---	--------

You can find wiring diagrams and scale drawings from page 768

Type	Cable	Wire specification	Material housing / nut	U [V]	T _a [°C]	Protection	LEDs	Drawing no.	Order no.
Group 133 · Cable plug M12, 4-pole, 4-wire · Wiring diagram no. 3									
	5 m orange PVC cable	4 x 0.34 mm ² , Ø 4.9 mm	PVC / stainless steel 316L / 1.4404	250 AC 300 DC	-25...100	IP 65 / IP 67 / IP 68 / IP 69K	-	9	EVT072
	10 m orange PVC cable	4 x 0.34 mm ² , Ø 4.9 mm	PVC / stainless steel 316L / 1.4404	250 AC 300 DC	-25...100	IP 65 / IP 67 / IP 68 / IP 69K	-	9	EVT073
Group 134 · Wirable plug M12, 4-pole · Wiring diagram no. 2									
	wirable	...0.75 mm ² (Ø 4...6 mm)	PA / high-grade st. steel	240 AC/DC	-25...85	IP 67	-	10	E11858
		wirable	...0.75 mm ² (Ø 4...6 mm)	PA / high-grade st. steel	250 AC/DC	-25...85	IP 67	-	11
Group 135 · Cable plug M12, 5-pole, 5-wire · Wiring diagram no. 4									
	2 m orange PVC cable	5 x 0.34 mm ² , Ø 5.1 mm	PVC / stainless steel 316L / 1.4404	60 AC 60 DC	-25...100	IP 65 / IP 67 / IP 68 / IP 69K	-	12	EVT074
Group 136 · Wirable plug M12, 5-pole · Wiring diagram no. 5									
	wirable	...0.75 mm ² (Ø 4...6 mm)	PA / high-grade st. steel	60 AC/DC	-25...85	IP 67	-	13	E11860
		wirable	...0.75 mm ² (Ø 4...6 mm)	PA / high-grade st. steel	125 AC/DC	-25...85	IP 67	-	14

Wiring diagrams

Core colours

BK	black
BN	brown
BU	blue
WH	white
GY	grey

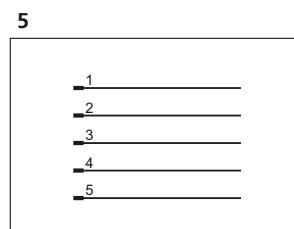
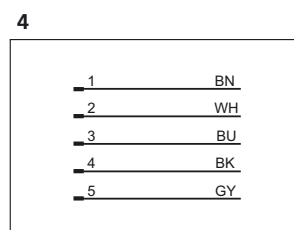
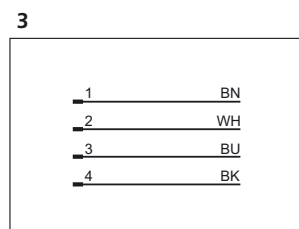
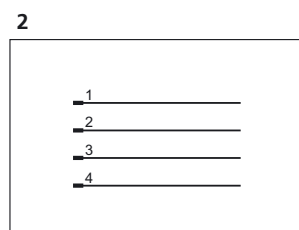
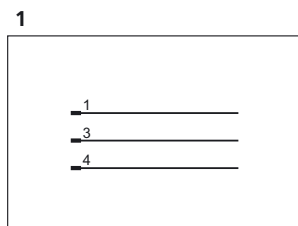

Scale drawings / drawing no. – CAD download: www.ifm.com

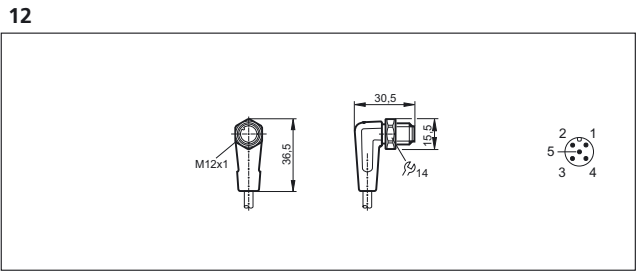
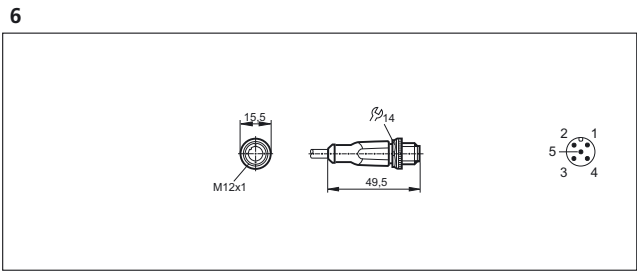
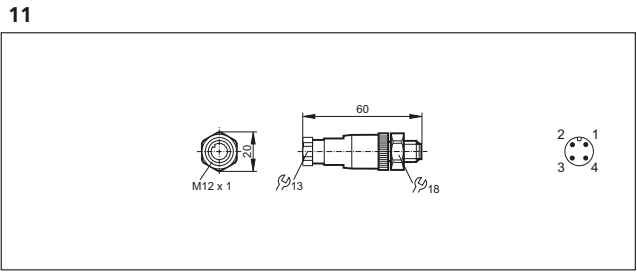
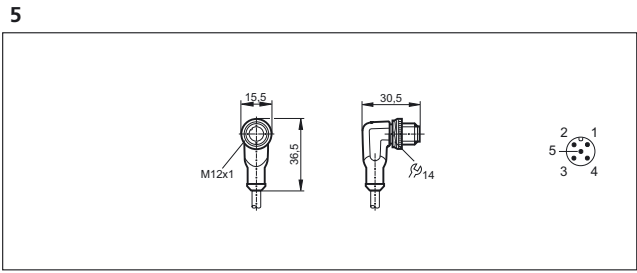
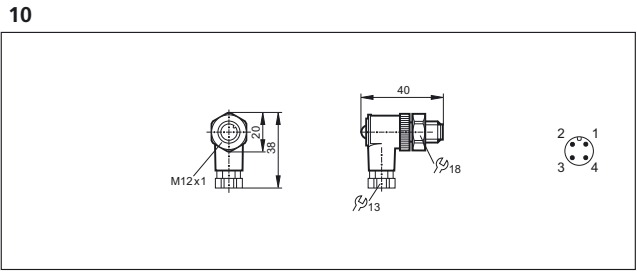
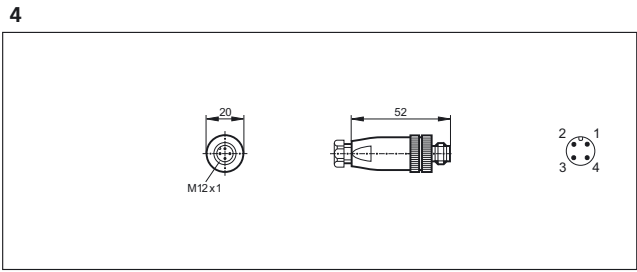
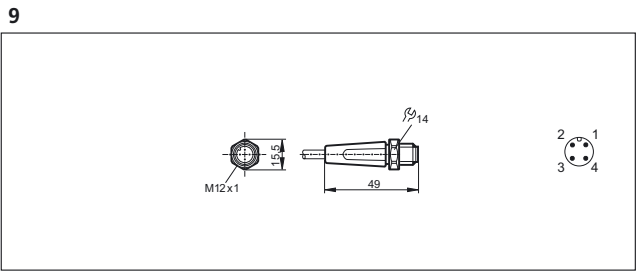
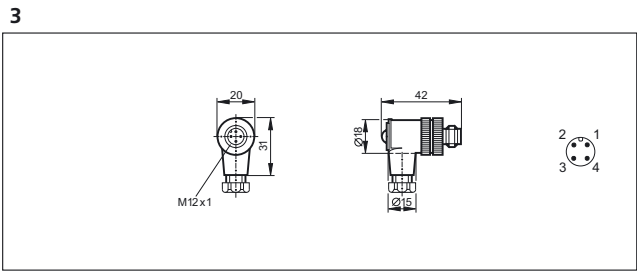
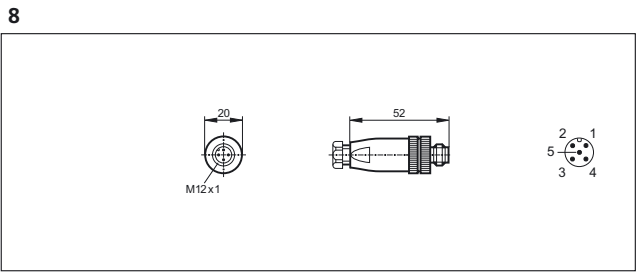
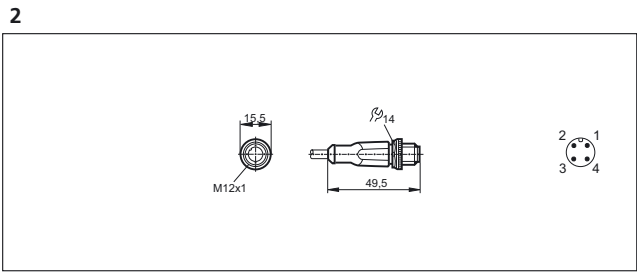
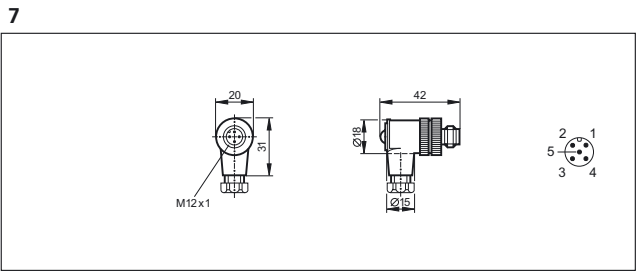
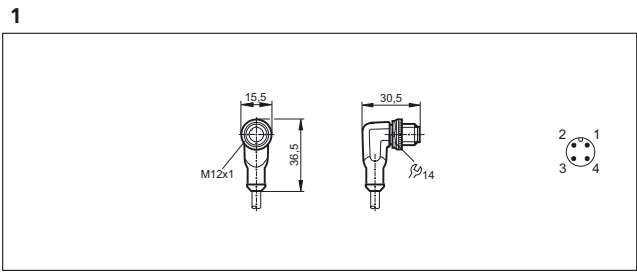

Scale drawings / drawing no. – CAD download: www.ifm.com

13

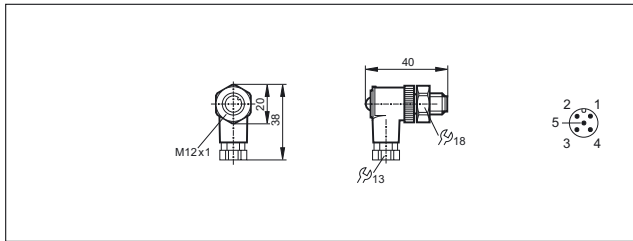

14

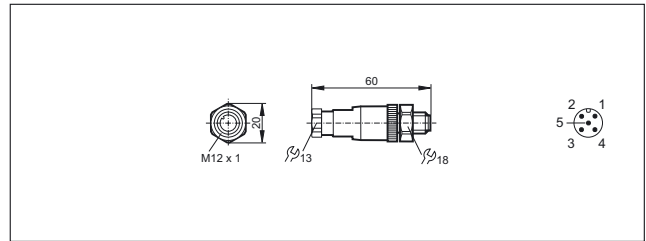





Jumper cables

Connection cables feature a plug and a socket. They are used for the connection of sensors to splitter boxes and modules.



High-quality contacts and materials ensure reliable electrical connections.





In addition to a wide range of standard products ifm also offers versions without silicone and halogen, versions for hygienic areas, for applications in contact with coolants and lubricants, as well as for welding applications.

System overview	Page
M8 – M8 jumpers for industrial applications	772 - 775
M8 socket – M12 plug jumpers for industrial applications	776 - 778
M8 plug - M12 socket jumpers for industrial applications	778 - 780
M12 – M12 jumpers for industrial applications	780 - 784
Valve - plug jumpers for industrial applications	785 - 786
Jumpers weld slag resistant	787 - 788
Jumpers for hygienic and wet areas	788 - 794
Jumpers for hygienic and wet areas	794 - 798
Jumpers for hazardous areas	798
Wiring diagrams	799
Scale drawings / drawing no. – CAD download: www.ifm.com	799 - 804

M8 – M8 jumpers for industrial applications



Type	Cable	Wire specification	Material housing / nut	U [V]	T _a [°C]	Protection	LEDs	Drawing no.	Order no.
Group 41 · Jumper , plug: M8, 3-pole, socket: M8, 3-pole, 3-wire · Wiring diagram no. 1									
	0.3 m black PUR cable	3 x 0.25 mm ² , Ø 3.7 mm	TPU / Brass	50 AC 60 DC	-25...90	IP 65 / IP 67 / IP 68 / IP 69K	–	1	EVC275
	0.6 m black PUR cable	3 x 0.25 mm ² , Ø 3.7 mm	TPU / Brass	50 AC 60 DC	-25...90	IP 65 / IP 67 / IP 68 / IP 69K	–	1	EVC276
	1 m black PUR cable	3 x 0.25 mm ² , Ø 3.7 mm	TPU / Brass	50 AC 60 DC	-25...90	IP 65 / IP 67 / IP 68 / IP 69K	–	1	EVC277
	2 m black PUR cable	3 x 0.25 mm ² , Ø 3.7 mm	TPU / Brass	50 AC 60 DC	-25...90	IP 65 / IP 67 / IP 68 / IP 69K	–	1	EVC278

Type	Cable	Wire specification	Material housing / nut	U [V]	T _a [°C]	Protection	LEDs	Drawing no.	Order no.
Group 41 · Jumper , plug: M8, 3-pole, socket: M8, 3-pole, 3-wire · Wiring diagram no. 1									
	5 m black PUR cable	3 x 0.25 mm ² , Ø 3.7 mm	TPU / Brass	50 AC 60 DC	-25...90	IP 65 / IP 67 / IP 68 / IP 69K	-	1	EVC279
	0.3 m black PUR cable	3 x 0.25 mm ² , Ø 3.7 mm	TPU / Brass	50 AC 60 DC	-25...90	IP 65 / IP 67 / IP 68 / IP 69K	-	2	EVC265
	0.6 m black PUR cable	3 x 0.25 mm ² , Ø 3.7 mm	TPU / Brass	50 AC 60 DC	-25...90	IP 65 / IP 67 / IP 68 / IP 69K	-	2	EVC266
	1 m black PUR cable	3 x 0.25 mm ² , Ø 3.7 mm	TPU / Brass	50 AC 60 DC	-25...90	IP 65 / IP 67 / IP 68 / IP 69K	-	2	EVC267
	2 m black PUR cable	3 x 0.25 mm ² , Ø 3.7 mm	TPU / Brass	50 AC 60 DC	-25...90	IP 65 / IP 67 / IP 68 / IP 69K	-	2	EVC268
	5 m black PUR cable	3 x 0.25 mm ² , Ø 3.7 mm	TPU / Brass	50 AC 60 DC	-25...90	IP 65 / IP 67 / IP 68 / IP 69K	-	2	EVC269
Group 42 · Jumper , plug: M8, 3-pole, socket: M8, 3-pole, 3-wire, LED, PNP · Wiring diagram no. 2									
	0.3 m black PUR cable	3 x 0.25 mm ² , Ø 3.7 mm	TPU / Brass	10...36 DC	-25...90	IP 65 / IP 67 / IP 68 / IP 69K	green / yellow	1	EVC280
	0.6 m black PUR cable	3 x 0.25 mm ² , Ø 3.7 mm	TPU / Brass	10...36 DC	-25...90	IP 65 / IP 67 / IP 68 / IP 69K	green / yellow	1	EVC281
	1 m black PUR cable	3 x 0.25 mm ² , Ø 3.7 mm	TPU / Brass	10...36 DC	-25...90	IP 65 / IP 67 / IP 68 / IP 69K	green / yellow	1	EVC282
	2 m black PUR cable	3 x 0.25 mm ² , Ø 3.7 mm	TPU / Brass	10...36 DC	-25...90	IP 65 / IP 67 / IP 68 / IP 69K	green / yellow	1	EVC283
	5 m black PUR cable	3 x 0.25 mm ² , Ø 3.7 mm	TPU / Brass	10...36 DC	-25...90	IP 65 / IP 67 / IP 68 / IP 69K	green / yellow	1	EVC284
Group 43 · Jumper , plug: M8, 4-pole, socket: M8, 3-pole, 3-wire · Wiring diagram no. 1									
	0.3 m black PUR cable	3 x 0.25 mm ² , Ø 3.7 mm	TPU / Brass	50 AC 60 DC	-25...90	IP 65 / IP 67 / IP 68 / IP 69K	-	3	EVC305
	0.6 m black PUR cable	3 x 0.25 mm ² , Ø 3.7 mm	TPU / Brass	50 AC 60 DC	-25...90	IP 65 / IP 67 / IP 68 / IP 69K	-	3	EVC306
	1 m black PUR cable	3 x 0.25 mm ² , Ø 3.7 mm	TPU / Brass	50 AC 60 DC	-25...90	IP 65 / IP 67 / IP 68 / IP 69K	-	3	EVC307

Type	Cable	Wire specification	Material housing / nut	U [V]	T _a [°C]	Protection	LEDs	Drawing no.	Order no.
Group 43 · Jumper , plug: M8, 4-pole, socket: M8, 3-pole, 3-wire · Wiring diagram no. 1									
	2 m black PUR cable	3 x 0.25 mm ² , Ø 3.7 mm	TPU / Brass	50 AC 60 DC	-25...90	IP 65 / IP 67 / IP 68 / IP 69K	–	3	EVC308
	5 m black PUR cable	3 x 0.25 mm ² , Ø 3.7 mm	TPU / Brass	50 AC 60 DC	-25...90	IP 65 / IP 67 / IP 68 / IP 69K	–	3	EVC309
	0.3 m black PUR cable	3 x 0.25 mm ² , Ø 3.7 mm	TPU / Brass	50 AC 60 DC	-25...90	IP 65 / IP 67 / IP 68 / IP 69K	–	4	EVC315
	0.6 m black PUR cable	3 x 0.25 mm ² , Ø 3.7 mm	TPU / Brass	50 AC 60 DC	-25...90	IP 65 / IP 67 / IP 68 / IP 69K	–	4	EVC316
	1 m black PUR cable	3 x 0.25 mm ² , Ø 3.7 mm	TPU / Brass	50 AC 60 DC	-25...90	IP 65 / IP 67 / IP 68 / IP 69K	–	4	EVC317
	2 m black PUR cable	3 x 0.25 mm ² , Ø 3.7 mm	TPU / Brass	50 AC 60 DC	-25...90	IP 65 / IP 67 / IP 68 / IP 69K	–	4	EVC318
	5 m black PUR cable	3 x 0.25 mm ² , Ø 3.7 mm	TPU / Brass	50 AC 60 DC	-25...90	IP 65 / IP 67 / IP 68 / IP 69K	–	4	EVC319
Group 44 · Jumper , plug: M8, 3-pole, socket: M8, 4-pole, 3-wire · Wiring diagram no. 1									
	0.3 m black PUR cable	3 x 0.25 mm ² , Ø 3.7 mm	TPU / Brass	50 AC 60 DC	-25...90	IP 65 / IP 67 / IP 68 / IP 69K	–	5	EVC260
	0.6 m black PUR cable	3 x 0.25 mm ² , Ø 3.7 mm	TPU / Brass	50 AC 60 DC	-25...90	IP 65 / IP 67 / IP 68 / IP 69K	–	5	EVC261
	1 m black PUR cable	3 x 0.25 mm ² , Ø 3.7 mm	TPU / Brass	50 AC 60 DC	-25...90	IP 65 / IP 67 / IP 68 / IP 69K	–	5	EVC262
	2 m black PUR cable	3 x 0.25 mm ² , Ø 3.7 mm	TPU / Brass	50 AC 60 DC	-25...90	IP 65 / IP 67 / IP 68 / IP 69K	–	5	EVC263
	5 m black PUR cable	3 x 0.25 mm ² , Ø 3.7 mm	TPU / Brass	50 AC 60 DC	-25...90	IP 65 / IP 67 / IP 68 / IP 69K	–	5	EVC264
	0.3 m black PUR cable	3 x 0.25 mm ² , Ø 3.7 mm	TPU / Brass	50 AC 60 DC	-25...90	IP 65 / IP 67 / IP 68 / IP 69K	–	6	EVC270
	0.6 m black PUR cable	3 x 0.25 mm ² , Ø 3.7 mm	TPU / Brass	50 AC 60 DC	-25...90	IP 65 / IP 67 / IP 68 / IP 69K	–	6	EVC271
	1 m black PUR cable	3 x 0.25 mm ² , Ø 3.7 mm	TPU / Brass	50 AC 60 DC	-25...90	IP 65 / IP 67 / IP 68 / IP 69K	–	6	EVC272

Type	Cable	Wire specification	Material housing / nut	U [V]	T _a [°C]	Protection	LEDs	Drawing no.	Order no.
Group 44 · Jumper , plug: M8, 3-pole, socket: M8, 4-pole, 3-wire · Wiring diagram no. 1									
	2 m black PUR cable	3 x 0.25 mm ² , Ø 3.7 mm	TPU / Brass	50 AC 60 DC	-25...90	IP 65 / IP 67 / IP 68 / IP 69K	–	6	EVC273
	5 m black PUR cable	3 x 0.25 mm ² , Ø 3.7 mm	TPU / Brass	50 AC 60 DC	-25...90	IP 65 / IP 67 / IP 68 / IP 69K	–	6	EVC274
Group 45 · Jumper , plug: M8, 4-pole, socket: M8, 4-pole, 4-wire · Wiring diagram no. 3									
	0.3 m black PUR cable	4 x 0.25 mm ² , Ø 3.7 mm	TPU / Brass	50 AC 60 DC	-25...90	IP 65 / IP 67 / IP 68 / IP 69K	–	7	EVC300
	0.6 m black PUR cable	4 x 0.25 mm ² , Ø 3.7 mm	TPU / Brass	50 AC 60 DC	-25...90	IP 65 / IP 67 / IP 68 / IP 69K	–	7	EVC301
	1 m black PUR cable	4 x 0.25 mm ² , Ø 3.7 mm	TPU / Brass	50 AC 60 DC	-25...90	IP 65 / IP 67 / IP 68 / IP 69K	–	7	EVC302
	2 m black PUR cable	4 x 0.25 mm ² , Ø 3.7 mm	TPU / Brass	50 AC 60 DC	-25...90	IP 65 / IP 67 / IP 68 / IP 69K	–	7	EVC303
	5 m black PUR cable	4 x 0.25 mm ² , Ø 3.7 mm	TPU / Brass	50 AC 60 DC	-25...90	IP 65 / IP 67 / IP 68 / IP 69K	–	7	EVC304
	0.3 m black PUR cable	4 x 0.25 mm ² , Ø 3.7 mm	TPU / Brass	50 AC 60 DC	-25...90	IP 65 / IP 67 / IP 68 / IP 69K	–	8	EVC310
	0.6 m black PUR cable	4 x 0.25 mm ² , Ø 3.7 mm	TPU / Brass	50 AC 60 DC	-25...90	IP 65 / IP 67 / IP 68 / IP 69K	–	8	EVC311
	1 m black PUR cable	4 x 0.25 mm ² , Ø 3.7 mm	TPU / Brass	50 AC 60 DC	-25...90	IP 65 / IP 67 / IP 68 / IP 69K	–	8	EVC312
	2 m black PUR cable	4 x 0.25 mm ² , Ø 3.7 mm	TPU / Brass	50 AC 60 DC	-25...90	IP 65 / IP 67 / IP 68 / IP 69K	–	8	EVC313
	5 m black PUR cable	4 x 0.25 mm ² , Ø 3.7 mm	TPU / Brass	50 AC 60 DC	-25...90	IP 65 / IP 67 / IP 68 / IP 69K	–	8	EVC314

M8 socket – M12 plug jumpers for industrial applications

Type	Cable	Wire specification	Material housing / nut	U [V]	T _a [°C]	Protection	LEDs	Drawing no.	Order no.
Group 46 · Jumper , plug: M12, 3-pole, socket: M8, 3-pole, 3-wire · Wiring diagram no. 1									
	0.3 m black PUR cable	3 x 0.34 mm ² , Ø 4.9 mm	TPU / Brass	50 AC 60 DC	-25...90	IP 65 / IP 67 / IP 68 / IP 69K	–	9	EVC230
	0.6 m black PUR cable	3 x 0.34 mm ² , Ø 4.9 mm	TPU / Brass	50 AC 60 DC	-25...90	IP 65 / IP 67 / IP 68 / IP 69K	–	9	EVC231
	1 m black PUR cable	3 x 0.34 mm ² , Ø 4.9 mm	TPU / Brass	50 AC 60 DC	-25...90	IP 65 / IP 67 / IP 68 / IP 69K	–	9	EVC232
	2 m black PUR cable	3 x 0.34 mm ² , Ø 4.9 mm	TPU / Brass	50 AC 60 DC	-25...90	IP 65 / IP 67 / IP 68 / IP 69K	–	9	EVC233
	5 m black PUR cable	3 x 0.34 mm ² , Ø 4.9 mm	TPU / Brass	50 AC 60 DC	-25...90	IP 65 / IP 67 / IP 68 / IP 69K	–	9	EVC234
	0.3 m black PUR cable	3 x 0.34 mm ² , Ø 4.9 mm	TPU / Brass	50 AC 60 DC	-25...90	IP 65 / IP 67 / IP 68 / IP 69K	–	10	EVC215
	0.6 m black PUR cable	3 x 0.34 mm ² , Ø 4.9 mm	TPU / Brass	50 AC 60 DC	-25...90	IP 65 / IP 67 / IP 68 / IP 69K	–	10	EVC216
	1 m black PUR cable	3 x 0.34 mm ² , Ø 4.9 mm	TPU / Brass	50 AC 60 DC	-25...90	IP 65 / IP 67 / IP 68 / IP 69K	–	10	EVC217
	2 m black PUR cable	3 x 0.34 mm ² , Ø 4.9 mm	TPU / Brass	50 AC 60 DC	-25...90	IP 65 / IP 67 / IP 68 / IP 69K	–	10	EVC218
	5 m black PUR cable	3 x 0.34 mm ² , Ø 4.9 mm	TPU / Brass	50 AC 60 DC	-25...90	IP 65 / IP 67 / IP 68 / IP 69K	–	10	EVC219
Group 47 · Jumper , plug: M12, 3-pole, socket: M8, 3-pole, 3-wire, LED, PNP · Wiring diagram no. 2									
	0.3 m black PUR cable	3 x 0.34 mm ² , Ø 4.9 mm	TPU / Brass	10...36 DC	-25...90	IP 65 / IP 67 / IP 68 / IP 69K	green / yellow	11	EVC225
	0.6 m black PUR cable	3 x 0.34 mm ² , Ø 4.9 mm	TPU / Brass	10...36 DC	-25...90	IP 65 / IP 67 / IP 68 / IP 69K	green / yellow	11	EVC226
	1 m black PUR cable	3 x 0.34 mm ² , Ø 4.9 mm	TPU / Brass	10...36 DC	-25...90	IP 65 / IP 67 / IP 68 / IP 69K	green / yellow	11	EVC227
	2 m black PUR cable	3 x 0.34 mm ² , Ø 4.9 mm	TPU / Brass	10...36 DC	-25...90	IP 65 / IP 67 / IP 68 / IP 69K	green / yellow	11	EVC228

Type	Cable	Wire specification	Material housing / nut	U [V]	T _a [°C]	Protection	LEDs	Drawing no.	Order no.
------	-------	--------------------	------------------------	-------	---------------------	------------	------	-------------	-----------

Group 47 · Jumper , plug: M12, 3-pole, socket: M8, 3-pole, 3-wire, LED, PNP · Wiring diagram no. 2



5 m black PUR cable	3 x 0.34 mm ² , Ø 4.9 mm	TPU / Brass	10...36 DC	-25...90	IP 65 / IP 67 / IP 68 / IP 69K	green / yellow	11	EVC229
---------------------	-------------------------------------	-------------	------------	----------	--------------------------------	----------------	----	---------------



Group 48 · Jumper , plug: M12, 3-pole, socket: M8, 4-pole, 3-wire · Wiring diagram no. 1

	0.3 m black PUR cable	3 x 0.34 mm ² , Ø 4.9 mm	TPU / Brass	50 AC 60 DC	-25...90	IP 65 / IP 67 / IP 68 / IP 69K	–	12	EVC210
	0.6 m black PUR cable	3 x 0.34 mm ² , Ø 4.9 mm	TPU / Brass	50 AC 60 DC	-25...90	IP 65 / IP 67 / IP 68 / IP 69K	–	12	EVC211
	1 m black PUR cable	3 x 0.34 mm ² , Ø 4.9 mm	TPU / Brass	50 AC 60 DC	-25...90	IP 65 / IP 67 / IP 68 / IP 69K	–	12	EVC212
	2 m black PUR cable	3 x 0.34 mm ² , Ø 4.9 mm	TPU / Brass	50 AC 60 DC	-25...90	IP 65 / IP 67 / IP 68 / IP 69K	–	12	EVC213
	5 m black PUR cable	3 x 0.34 mm ² , Ø 4.9 mm	TPU / Brass	50 AC 60 DC	-25...90	IP 65 / IP 67 / IP 68 / IP 69K	–	12	EVC214

	0.3 m black PUR cable	3 x 0.34 mm ² , Ø 4.9 mm	TPU / Brass	50 AC 60 DC	-25...90	IP 65 / IP 67 / IP 68 / IP 69K	–	13	EVC220
	0.6 m black PUR cable	3 x 0.34 mm ² , Ø 4.9 mm	TPU / Brass	50 AC 60 DC	-25...90	IP 65 / IP 67 / IP 68 / IP 69K	–	13	EVC221
	1 m black PUR cable	3 x 0.34 mm ² , Ø 4.9 mm	TPU / Brass	50 AC 60 DC	-25...90	IP 65 / IP 67 / IP 68 / IP 69K	–	13	EVC222
	2 m black PUR cable	3 x 0.34 mm ² , Ø 4.9 mm	TPU / Brass	50 AC 60 DC	-25...90	IP 65 / IP 67 / IP 68 / IP 69K	–	13	EVC223
	5 m black PUR cable	3 x 0.34 mm ² , Ø 4.9 mm	TPU / Brass	50 AC 60 DC	-25...90	IP 65 / IP 67 / IP 68 / IP 69K	–	13	EVC224

Group 49 · Jumper , plug: M12, 4-pole, socket: M8, 4-pole, 4-wire · Wiring diagram no. 3

	0.3 m black PUR cable	4 x 0.34 mm ² , Ø 4.9 mm	TPU / Brass	50 AC 60 DC	-25...90	IP 65 / IP 67 / IP 68 / IP 69K	–	14	EVC235
	0.6 m black PUR cable	4 x 0.34 mm ² , Ø 4.9 mm	TPU / Brass	50 AC 60 DC	-25...90	IP 65 / IP 67 / IP 68 / IP 69K	–	14	EVC236
	1 m black PUR cable	4 x 0.34 mm ² , Ø 4.9 mm	TPU / Brass	50 AC 60 DC	-25...90	IP 65 / IP 67 / IP 68 / IP 69K	–	14	EVC237

Type	Cable	Wire specification	Material housing / nut	U [V]	T _a [°C]	Pro-tection	LEDs	Draw-ing no.	Order no.
Group 49 · Jumper , plug: M12, 4-pole, socket: M8, 4-pole, 4-wire · Wiring diagram no. 3									
	2 m black PUR cable	4 x 0.34 mm ² , Ø 4.9 mm	TPU / Brass	50 AC 60 DC	-25...90	IP 65 / IP 67 / IP 68 / IP 69K	–	14	EVC238
	5 m black PUR cable	4 x 0.34 mm ² , Ø 4.9 mm	TPU / Brass	50 AC 60 DC	-25...90	IP 65 / IP 67 / IP 68 / IP 69K	–	14	EVC239
	0.3 m black PUR cable	4 x 0.34 mm ² , Ø 4.9 mm	TPU / Brass	50 AC 60 DC	-25...90	IP 65 / IP 67 / IP 68 / IP 69K	–	15	EVC240
	0.6 m black PUR cable	4 x 0.34 mm ² , Ø 4.9 mm	TPU / Brass	50 AC 60 DC	-25...90	IP 65 / IP 67 / IP 68 / IP 69K	–	15	EVC241
	1 m black PUR cable	4 x 0.34 mm ² , Ø 4.9 mm	TPU / Brass	50 AC 60 DC	-25...90	IP 65 / IP 67 / IP 68 / IP 69K	–	15	EVC242
	2 m black PUR cable	4 x 0.34 mm ² , Ø 4.9 mm	TPU / Brass	50 AC 60 DC	-25...90	IP 65 / IP 67 / IP 68 / IP 69K	–	15	EVC243
	5 m black PUR cable	4 x 0.34 mm ² , Ø 4.9 mm	TPU / Brass	50 AC 60 DC	-25...90	IP 65 / IP 67 / IP 68 / IP 69K	–	15	EVC244

M8 plug - M12 socket jumpers for industrial applications

Type	Cable	Wire specification	Material housing / nut	U [V]	T _a [°C]	Pro-tection	LEDs	Draw-ing no.	Order no.
Group 50 · Jumper , plug: M8, 3-pole, socket: M12, 5/4-pole, 3-wire · Wiring diagram no. 1									
	0.3 m black PUR cable	3 x 0.34 mm ² , Ø 4.9 mm	TPU / Brass	50 AC 60 DC	-25...90	IP 65 / IP 67 / IP 68 / IP 69K	–	16	EVC245
	0.6 m black PUR cable	3 x 0.34 mm ² , Ø 4.9 mm	TPU / Brass	50 AC 60 DC	-25...90	IP 65 / IP 67 / IP 68 / IP 69K	–	16	EVC246
	1 m black PUR cable	3 x 0.34 mm ² , Ø 4.9 mm	TPU / Brass	50 AC 60 DC	-25...90	IP 65 / IP 67 / IP 68 / IP 69K	–	16	EVC247
	2 m black PUR cable	3 x 0.34 mm ² , Ø 4.9 mm	TPU / Brass	50 AC 60 DC	-25...90	IP 65 / IP 67 / IP 68 / IP 69K	–	16	EVC248
	5 m black PUR cable	3 x 0.34 mm ² , Ø 4.9 mm	TPU / Brass	50 AC 60 DC	-25...90	IP 65 / IP 67 / IP 68 / IP 69K	–	16	EVC249

Type	Cable	Wire specification	Material housing / nut	U [V]	T _a [°C]	Protection	LEDs	Drawing no.	Order no.
Group 51 · Jumper , plug: M8, 3-pole, socket: M12, 5-pole, 3-wire · Wiring diagram no. 1									
	0.3 m black PUR cable	3 x 0.34 mm ² , Ø 4.9 mm	TPU / Brass	50 AC 60 DC	-25...90	IP 65 / IP 67 / IP 68 / IP 69K	-	17	EVC255
	0.6 m black PUR cable	3 x 0.34 mm ² , Ø 4.9 mm	TPU / Brass	50 AC 60 DC	-25...90	IP 65 / IP 67 / IP 68 / IP 69K	-	17	EVC256
	1 m black PUR cable	3 x 0.34 mm ² , Ø 4.9 mm	TPU / Brass	50 AC 60 DC	-25...90	IP 65 / IP 67 / IP 68 / IP 69K	-	17	EVC257
	2 m black PUR cable	3 x 0.34 mm ² , Ø 4.9 mm	TPU / Brass	50 AC 60 DC	-25...90	IP 65 / IP 67 / IP 68 / IP 69K	-	17	EVC258
	5 m black PUR cable	3 x 0.34 mm ² , Ø 4.9 mm	TPU / Brass	50 AC 60 DC	-25...90	IP 65 / IP 67 / IP 68 / IP 69K	-	17	EVC259
Group 52 · Jumper , plug: M8, 3-pole, socket: M12, 5-pole, 3-wire, LED, PNP · Wiring diagram no. 2									
	0.3 m black PUR cable	3 x 0.34 mm ² , Ø 4.9 mm	TPU / Brass	10...36 DC	-25...90	IP 65 / IP 67 / IP 68 / IP 69K	green / yellow	18	EVC250
	0.6 m black PUR cable	3 x 0.34 mm ² , Ø 4.9 mm	TPU / Brass	10...36 DC	-25...90	IP 65 / IP 67 / IP 68 / IP 69K	green / yellow	18	EVC251
	1 m black PUR cable	3 x 0.34 mm ² , Ø 4.9 mm	TPU / Brass	10...36 DC	-25...90	IP 65 / IP 67 / IP 68 / IP 69K	green / yellow	18	EVC252
	2 m black PUR cable	3 x 0.34 mm ² , Ø 4.9 mm	TPU / Brass	10...36 DC	-25...90	IP 65 / IP 67 / IP 68 / IP 69K	green / yellow	18	EVC253
	5 m black PUR cable	3 x 0.34 mm ² , Ø 4.9 mm	TPU / Brass	10...36 DC	-25...90	IP 65 / IP 67 / IP 68 / IP 69K	green / yellow	18	EVC254
Group 53 · Jumper , plug: M8, 4-pole, socket: M12, 5-pole, 4-wire · Wiring diagram no. 3									
	0.3 m black PUR cable	4 x 0.34 mm ² , Ø 4.9 mm	TPU / Brass	50 AC 60 DC	-25...90	IP 65 / IP 67 / IP 68 / IP 69K	-	19	EVC285
	0.6 m black PUR cable	4 x 0.34 mm ² , Ø 4.9 mm	TPU / Brass	50 AC 60 DC	-25...90	IP 65 / IP 67 / IP 68 / IP 69K	-	19	EVC286
	1 m black PUR cable	4 x 0.34 mm ² , Ø 4.9 mm	TPU / Brass	50 AC 60 DC	-25...90	IP 65 / IP 67 / IP 68 / IP 69K	-	19	EVC287
	2 m black PUR cable	4 x 0.34 mm ² , Ø 4.9 mm	TPU / Brass	50 AC 60 DC	-25...90	IP 65 / IP 67 / IP 68 / IP 69K	-	19	EVC288

Type	Cable	Wire specification	Material housing / nut	U [V]	T _a [°C]	Protection	LEDs	Drawing no.	Order no.
------	-------	--------------------	------------------------	-------	---------------------	------------	------	-------------	-----------

Group 53 · Jumper , plug: M8, 4-pole, socket: M12, 5-pole, 4-wire · Wiring diagram no. 3



5 m black PUR cable	4 x 0.34 mm ² , Ø 4.9 mm	TPU / Brass	50 AC 60 DC	-25...90	IP 65 / IP 67 / IP 68 / IP 69K	–	19	EVC289
---------------------	-------------------------------------	-------------	----------------	----------	-----------------------------------	---	----	---------------

Group 54 · Jumper , plug: M8, 4-pole, socket: M12, 5/4-pole, 4-wire · Wiring diagram no. 3

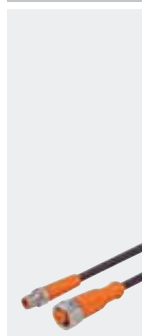

0.3 m black PUR cable	4 x 0.34 mm ² , Ø 4.9 mm	TPU / Brass	50 AC 60 DC	-25...90	IP 65 / IP 67 / IP 68 / IP 69K	–	20	EVC295
0.6 m black PUR cable	4 x 0.34 mm ² , Ø 4.9 mm	TPU / Brass	50 AC 60 DC	-25...90	IP 65 / IP 67 / IP 68 / IP 69K	–	20	EVC296
1 m black PUR cable	4 x 0.34 mm ² , Ø 4.9 mm	TPU / Brass	50 AC 60 DC	-25...90	IP 65 / IP 67 / IP 68 / IP 69K	–	20	EVC297
2 m black PUR cable	4 x 0.34 mm ² , Ø 4.9 mm	TPU / Brass	50 AC 60 DC	-25...90	IP 65 / IP 67 / IP 68 / IP 69K	–	20	EVC298
5 m black PUR cable	4 x 0.34 mm ² , Ø 4.9 mm	TPU / Brass	50 AC 60 DC	-25...90	IP 65 / IP 67 / IP 68 / IP 69K	–	20	EVC299

Group 55 · Jumper , plug: M8, 4-pole, socket: M12, 5-pole, 4-wire, LED, PNP · Wiring diagram no. 4

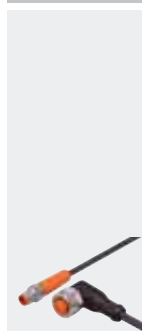

0.3 m black PUR cable	4 x 0.34 mm ² , Ø 4.9 mm	TPU / Brass	10...36 DC	-25...90	IP 65 / IP 67 / IP 68 / IP 69K	green / 2 x yellow	21	EVC290
0.6 m black PUR cable	4 x 0.34 mm ² , Ø 4.9 mm	TPU / Brass	10...36 DC	-25...90	IP 65 / IP 67 / IP 68 / IP 69K	green / 2 x yellow	21	EVC291
1 m black PUR cable	4 x 0.34 mm ² , Ø 4.9 mm	TPU / Brass	10...36 DC	-25...90	IP 65 / IP 67 / IP 68 / IP 69K	green / 2 x yellow	21	EVC292
2 m black PUR cable	4 x 0.34 mm ² , Ø 4.9 mm	TPU / Brass	10...36 DC	-25...90	IP 65 / IP 67 / IP 68 / IP 69K	green / 2 x yellow	21	EVC293
5 m black PUR cable	4 x 0.34 mm ² , Ø 4.9 mm	TPU / Brass	10...36 DC	-25...90	IP 65 / IP 67 / IP 68 / IP 69K	green / 2 x yellow	21	EVC294

M12 – M12 jumpers for industrial applications



Type	Cable	Wire specification	Material housing / nut	U [V]	T _a [°C]	Protection	LEDs	Drawing no.	Order no.
------	-------	--------------------	------------------------	-------	---------------------	------------	------	-------------	-----------

Group 56 · Jumper , plug: M12, 3-pole, socket: M12, 5-pole, 3-wire · Wiring diagram no. 1



0.3 m black PUR cable	3 x 0.34 mm ² , Ø 4.9 mm	TPU / Brass	250 AC 300 DC	-25...90	IP 65 / IP 67 / IP 68 / IP 69K	–	22	EVC045
-----------------------	-------------------------------------	-------------	------------------	----------	-----------------------------------	---	----	---------------

Type	Cable	Wire specification	Material housing / nut	U [V]	T _a [°C]	Protection	LEDs	Drawing no.	Order no.
Group 56 · Jumper , plug: M12, 3-pole, socket: M12, 5-pole, 3-wire · Wiring diagram no. 1									
	0.6 m black PUR cable	3 x 0.34 mm ² , Ø 4.9 mm	TPU / Brass	250 AC 300 DC	-25...90	IP 65 / IP 67 / IP 68 / IP 69K	-	22	EVC046
	1 m black PUR cable	3 x 0.34 mm ² , Ø 4.9 mm	TPU / Brass	250 AC 300 DC	-25...90	IP 65 / IP 67 / IP 68 / IP 69K	-	22	EVC047
	2 m black PUR cable	3 x 0.34 mm ² , Ø 4.9 mm	TPU / Brass	250 AC 300 DC	-25...90	IP 65 / IP 67 / IP 68 / IP 69K	-	22	EVC048
	5 m black PUR cable	3 x 0.34 mm ² , Ø 4.9 mm	TPU / Brass	250 AC 300 DC	-25...90	IP 65 / IP 67 / IP 68 / IP 69K	-	22	EVC049
	0.3 m black PUR cable	3 x 0.34 mm ² , Ø 4.9 mm	TPU / Brass	250 AC 300 DC	-25...90	IP 65 / IP 67 / IP 68 / IP 69K	-	23	EVC040
	0.6 m black PUR cable	3 x 0.34 mm ² , Ø 4.9 mm	TPU / Brass	250 AC 300 DC	-25...90	IP 65 / IP 67 / IP 68 / IP 69K	-	23	EVC041
	1 m black PUR cable	3 x 0.34 mm ² , Ø 4.9 mm	TPU / Brass	250 AC 300 DC	-25...90	IP 65 / IP 67 / IP 68 / IP 69K	-	23	EVC042
	2 m black PUR cable	3 x 0.34 mm ² , Ø 4.9 mm	TPU / Brass	250 AC 300 DC	-25...90	IP 65 / IP 67 / IP 68 / IP 69K	-	23	EVC043
	5 m black PUR cable	3 x 0.34 mm ² , Ø 4.9 mm	TPU / Brass	250 AC 300 DC	-25...90	IP 65 / IP 67 / IP 68 / IP 69K	-	23	EVC044
Group 58 · Jumper , plug: M12, 3-pole, socket: M12, 5-pole, 3-wire, LED, PNP · Wiring diagram no. 2									
	0.3 m black PUR cable	3 x 0.34 mm ² , Ø 4.9 mm	TPU / Brass	10...36 DC	-25...90	IP 65 / IP 67 / IP 68 / IP 69K	green / yellow	24	EVC050
	0.6 m black PUR cable	3 x 0.34 mm ² , Ø 4.9 mm	TPU / Brass	10...36 DC	-25...90	IP 65 / IP 67 / IP 68 / IP 69K	green / yellow	24	EVC051
	1 m black PUR cable	3 x 0.34 mm ² , Ø 4.9 mm	TPU / Brass	10...36 DC	-25...90	IP 65 / IP 67 / IP 68 / IP 69K	green / yellow	24	EVC052
	2 m black PUR cable	3 x 0.34 mm ² , Ø 4.9 mm	TPU / Brass	10...36 DC	-25...90	IP 65 / IP 67 / IP 68 / IP 69K	green / yellow	24	EVC053
	5 m black PUR cable	3 x 0.34 mm ² , Ø 4.9 mm	TPU / Brass	10...36 DC	-25...90	IP 65 / IP 67 / IP 68 / IP 69K	green / yellow	24	EVC054

Type	Cable	Wire specification	Material housing / nut	U [V]	T _a [°C]	Protection	LEDs	Drawing no.	Order no.
Group 60 · Jumper , plug: M12, 4-pole, socket: M12, 5/4-pole, 4-wire · Wiring diagram no. 3									
	0.3 m black PUR cable	4 x 0.34 mm ² , Ø 4.9 mm	TPU / Brass	250 AC 300 DC	-25...90	IP 65 / IP 67 / IP 68 / IP 69K	-	25	EVC015
	0.6 m black PUR cable	4 x 0.34 mm ² , Ø 4.9 mm	TPU / Brass	250 AC 300 DC	-25...90	IP 65 / IP 67 / IP 68 / IP 69K	-	25	EVC016
	1 m black PUR cable	4 x 0.34 mm ² , Ø 4.9 mm	TPU / Brass	250 AC 300 DC	-25...90	IP 65 / IP 67 / IP 68 / IP 69K	-	25	EVC017
	2 m black PUR cable	4 x 0.34 mm ² , Ø 4.9 mm	TPU / Brass	250 AC 300 DC	-25...90	IP 65 / IP 67 / IP 68 / IP 69K	-	25	EVC018
	5 m black PUR cable	4 x 0.34 mm ² , Ø 4.9 mm	TPU / Brass	250 AC 300 DC	-25...90	IP 65 / IP 67 / IP 68 / IP 69K	-	25	EVC019
	0.3 m black PUR cable	4 x 0.34 mm ² , Ø 4.9 mm	TPU / Brass	250 AC 300 DC	-25...90	IP 65 / IP 67 / IP 68 / IP 69K	-	26	EVC010
	0.6 m black PUR cable	4 x 0.34 mm ² , Ø 4.9 mm	TPU / Brass	250 AC 300 DC	-25...90	IP 65 / IP 67 / IP 68 / IP 69K	-	26	EVC011
	1 m black PUR cable	4 x 0.34 mm ² , Ø 4.9 mm	TPU / Brass	250 AC 300 DC	-25...90	IP 65 / IP 67 / IP 68 / IP 69K	-	26	EVC012
	2 m black PUR cable	4 x 0.34 mm ² , Ø 4.9 mm	TPU / Brass	250 AC 300 DC	-25...90	IP 65 / IP 67 / IP 68 / IP 69K	-	26	EVC013
	5 m black PUR cable	4 x 0.34 mm ² , Ø 4.9 mm	TPU / Brass	250 AC 300 DC	-25...90	IP 65 / IP 67 / IP 68 / IP 69K	-	26	EVC014
Group 61 · Jumper , plug: M12, 4-pole, socket: M12, 5/4-pole, 4-wire, LED, PNP · Wiring diagram no. 4									
	0.3 m black PUR cable	4 x 0.34 mm ² , Ø 4.9 mm	TPU / Brass	10...36 DC	-25...90	IP 65 / IP 67 / IP 68 / IP 69K	green / 2 x yellow	27	EVC020
	0.6 m black PUR cable	4 x 0.34 mm ² , Ø 4.9 mm	TPU / Brass	10...36 DC	-25...90	IP 65 / IP 67 / IP 68 / IP 69K	green / 2 x yellow	27	EVC021
	1 m black PUR cable	4 x 0.34 mm ² , Ø 4.9 mm	TPU / Brass	10...36 DC	-25...90	IP 65 / IP 67 / IP 68 / IP 69K	green / 2 x yellow	27	EVC022
	2 m black PUR cable	4 x 0.34 mm ² , Ø 4.9 mm	TPU / Brass	10...36 DC	-25...90	IP 65 / IP 67 / IP 68 / IP 69K	green / 2 x yellow	27	EVC023
	5 m black PUR cable	4 x 0.34 mm ² , Ø 4.9 mm	TPU / Brass	10...36 DC	-25...90	IP 65 / IP 67 / IP 68 / IP 69K	green / 2 x yellow	27	EVC024

Product selectors and further information can be found at: www.ifm.com

Type	Cable	Wire specification	Material housing / nut	U [V]	T _a [°C]	Protection	LEDs	Drawing no.	Order no.
------	-------	--------------------	------------------------	-------	---------------------	------------	------	-------------	-----------

Group 62 · Jumper , plug: M12, 4-pole, socket: M12, 5/4-pole, 4-wire · Wiring diagram no. 3



	0.3 m black PUR cable	4 x 0.34 mm ² , Ø 4.9 mm	TPU / Brass	250 AC 300 DC	-25...90	IP 65 / IP 67 / IP 68 / IP 69K	-	28	EVC025
	0.6 m black PUR cable	4 x 0.34 mm ² , Ø 4.9 mm	TPU / Brass	250 AC 300 DC	-25...90	IP 65 / IP 67 / IP 68 / IP 69K	-	28	EVC026
	1 m black PUR cable	4 x 0.34 mm ² , Ø 4.9 mm	TPU / Brass	250 AC 300 DC	-25...90	IP 65 / IP 67 / IP 68 / IP 69K	-	28	EVC027
	2 m black PUR cable	4 x 0.34 mm ² , Ø 4.9 mm	TPU / Brass	250 AC 300 DC	-25...90	IP 65 / IP 67 / IP 68 / IP 69K	-	28	EVC028
	5 m black PUR cable	4 x 0.34 mm ² , Ø 4.9 mm	TPU / Brass	250 AC 300 DC	-25...90	IP 65 / IP 67 / IP 68 / IP 69K	-	28	EVC029

	0.3 m black PUR cable	4 x 0.34 mm ² , Ø 4.9 mm	TPU / Brass	250 AC 300 DC	-25...90	IP 65 / IP 67 / IP 68 / IP 69K	-	29	EVC030
	0.6 m black PUR cable	4 x 0.34 mm ² , Ø 4.9 mm	TPU / Brass	250 AC 300 DC	-25...90	IP 65 / IP 67 / IP 68 / IP 69K	-	29	EVC031
	1 m black PUR cable	4 x 0.34 mm ² , Ø 4.9 mm	TPU / Brass	250 AC 300 DC	-25...90	IP 65 / IP 67 / IP 68 / IP 69K	-	29	EVC032
	2 m black PUR cable	4 x 0.34 mm ² , Ø 4.9 mm	TPU / Brass	250 AC 300 DC	-25...90	IP 65 / IP 67 / IP 68 / IP 69K	-	29	EVC033
	5 m black PUR cable	4 x 0.34 mm ² , Ø 4.9 mm	TPU / Brass	250 AC 300 DC	-25...90	IP 65 / IP 67 / IP 68 / IP 69K	-	29	EVC034



Group 63 · Jumper , plug: M12, 4-pole, socket: M12, 5/4-pole, 4-wire, LED, PNP · Wiring diagram no. 4

	0.3 m black PUR cable	4 x 0.34 mm ² , Ø 4.9 mm	TPU / Brass	10...36 DC	-25...90	IP 65 / IP 67 / IP 68 / IP 69K	green / 2 x yellow	30	EVC035
	0.6 m black PUR cable	4 x 0.34 mm ² , Ø 4.9 mm	TPU / Brass	10...36 DC	-25...90	IP 65 / IP 67 / IP 68 / IP 69K	green / 2 x yellow	30	EVC036
	1 m black PUR cable	4 x 0.34 mm ² , Ø 4.9 mm	TPU / Brass	10...36 DC	-25...90	IP 65 / IP 67 / IP 68 / IP 69K	green / 2 x yellow	30	EVC037
	2 m black PUR cable	4 x 0.34 mm ² , Ø 4.9 mm	TPU / Brass	10...36 DC	-25...90	IP 65 / IP 67 / IP 68 / IP 69K	green / 2 x yellow	30	EVC038
	5 m black PUR cable	4 x 0.34 mm ² , Ø 4.9 mm	TPU / Brass	10...36 DC	-25...90	IP 65 / IP 67 / IP 68 / IP 69K	green / 2 x yellow	30	EVC039

You can find wiring diagrams and scale drawings from page 799

Type	Cable	Wire specification	Material housing / nut	U [V]	T _a [°C]	Protection	LEDs	Drawing no.	Order no.
Group 64 · Jumper , plug: M12, 5-pole, socket: M12, 5-pole, 5-wire · Wiring diagram no. 5									
	0.3 m black PUR cable	5 x 0.34 mm ² , Ø 4.9 mm	TPU / Brass	60 AC 60 DC	-25...90	IP 65 / IP 67 / IP 68 / IP 69K	–	31	EVC060
	0.6 m black PUR cable	5 x 0.34 mm ² , Ø 4.9 mm	TPU / Brass	60 AC 60 DC	-25...90	IP 65 / IP 67 / IP 68 / IP 69K	–	31	EVC061
	1 m black PUR cable	5 x 0.34 mm ² , Ø 4.9 mm	TPU / Brass	60 AC 60 DC	-25...90	IP 65 / IP 67 / IP 68 / IP 69K	–	31	EVC062
	2 m black PUR cable	5 x 0.34 mm ² , Ø 4.9 mm	TPU / Brass	60 AC 60 DC	-25...90	IP 65 / IP 67 / IP 68 / IP 69K	–	31	EVC063
	5 m black PUR cable	5 x 0.34 mm ² , Ø 4.9 mm	TPU / Brass	60 AC 60 DC	-25...90	IP 65 / IP 67 / IP 68 / IP 69K	–	31	EVC064
	0.3 m black PUR cable	5 x 0.34 mm ² , Ø 4.9 mm	TPU / Brass	60 AC 60 DC	-25...90	IP 65 / IP 67 / IP 68 / IP 69K	–	32	EVC055
	0.6 m black PUR cable	5 x 0.34 mm ² , Ø 4.9 mm	TPU / Brass	60 AC 60 DC	-25...90	IP 65 / IP 67 / IP 68 / IP 69K	–	32	EVC056
	1 m black PUR cable	5 x 0.34 mm ² , Ø 4.9 mm	TPU / Brass	60 AC 60 DC	-25...90	IP 65 / IP 67 / IP 68 / IP 69K	–	32	EVC057
	2 m black PUR cable	5 x 0.34 mm ² , Ø 4.9 mm	TPU / Brass	60 AC 60 DC	-25...90	IP 65 / IP 67 / IP 68 / IP 69K	–	32	EVC058
	5 m black PUR cable	5 x 0.34 mm ² , Ø 4.9 mm	TPU / Brass	60 AC 60 DC	-25...90	IP 65 / IP 67 / IP 68 / IP 69K	–	32	EVC059
	0.3 m black PUR cable	5 x 0.34 mm ² , Ø 4.9 mm	TPU / Brass	60 AC 60 DC	-25...90	IP 65 / IP 67 / IP 68 / IP 69K	–	33	EVC065
	0.6 m black PUR cable	5 x 0.34 mm ² , Ø 4.9 mm	TPU / Brass	60 AC 60 DC	-25...90	IP 65 / IP 67 / IP 68 / IP 69K	–	33	EVC066
	1 m black PUR cable	5 x 0.34 mm ² , Ø 4.9 mm	TPU / Brass	60 AC 60 DC	-25...90	IP 65 / IP 67 / IP 68 / IP 69K	–	33	EVC067
	2 m black PUR cable	5 x 0.34 mm ² , Ø 4.9 mm	TPU / Brass	60 AC 60 DC	-25...90	IP 65 / IP 67 / IP 68 / IP 69K	–	33	EVC068
	5 m black PUR cable	5 x 0.34 mm ² , Ø 4.9 mm	TPU / Brass	60 AC 60 DC	-25...90	IP 65 / IP 67 / IP 68 / IP 69K	–	33	EVC069

Valve - plug jumpers for industrial applications

Type	Cable	Wire specification	Material housing / nut	U [V]	T _a [°C]	Protection	LEDs	Drawing no.	Order no.
Group 65 · Jumper , plug: M12, 3-pole, valve plug: Housing A, 4-pole, 3-wire, LED · Wiring diagram no. 6									
	0.3 m black PUR cable	3 x 0.5 mm ² , Ø 5 mm	PUR / Brass	24 AC/DC	-25...80	IP 67	yellow	34	E11416
	0.6 m black PUR cable	3 x 0.5 mm ² , Ø 5 mm	PUR / Brass	24 AC/DC	-25...80	IP 67	yellow	34	E11417
	1 m black PUR cable	3 x 0.5 mm ² , Ø 5 mm	PUR / Brass	24 AC/DC	-25...80	IP 67	yellow	34	E11418
	2 m black PUR cable	3 x 0.5 mm ² , Ø 5 mm	PUR / Brass	24 AC/DC	-25...80	IP 67	yellow	34	E11419
	5 m black PUR cable	3 x 0.5 mm ² , Ø 5 mm	PUR / Brass	24 AC/DC	-25...80	IP 67	yellow	34	E11420
Group 66 · Jumper , plug: M12, 3-pole, valve plug: Housing B, 3-pole, 3-wire, LED · Wiring diagram no. 7									
	0.3 m black PUR cable	3 x 0.5 mm ² , Ø 5 mm	PUR / Brass	24 AC/DC	-25...80	IP 67	yellow	35	E11421
	0.6 m black PUR cable	3 x 0.5 mm ² , Ø 5 mm	PUR / Brass	24 AC/DC	-25...80	IP 67	yellow	35	E11422
	1 m black PUR cable	3 x 0.5 mm ² , Ø 5 mm	PUR / Brass	24 AC/DC	-25...80	IP 67	yellow	35	E11423
	2 m black PUR cable	3 x 0.5 mm ² , Ø 5 mm	PUR / Brass	24 AC/DC	-25...80	IP 67	yellow	35	E11424
	5 m black PUR cable	3 x 0.5 mm ² , Ø 5 mm	PUR / Brass	24 AC/DC	-25...80	IP 67	yellow	35	E11425
Group 67 · Jumper , plug: M12, 3-pole, valve plug: Housing B (industrial standard), 3-pole, 3-wire, LED · Wiring diagram no. 7									
	0.3 m black PUR cable	3 x 0.5 mm ² , Ø 5 mm	PUR / Brass	24 AC/DC	-25...80	IP 67	yellow	36	E11431
	0.6 m black PUR cable	3 x 0.5 mm ² , Ø 5 mm	PUR / Brass	24 AC/DC	-25...80	IP 67	yellow	36	E11432
	1 m black PUR cable	3 x 0.5 mm ² , Ø 5 mm	PUR / Brass	24 AC/DC	-25...80	IP 67	yellow	36	E11433

Type	Cable	Wire specification	Material housing / nut	U [V]	T _a [°C]	Protection	LEDs	Drawing no.	Order no.
------	-------	--------------------	------------------------	-------	---------------------	------------	------	-------------	-----------

Group 67 · Jumper , plug: M12, 3-pole, valve plug: Housing B (industrial standard), 3-pole, 3-wire, LED · Wiring diagram no. 7

	2 m black PUR cable	3 x 0.5 mm ² , Ø 5 mm	PUR / Brass	24 AC/DC	-25...80	IP 67	yellow	36	E11434
	5 m black PUR cable	3 x 0.5 mm ² , Ø 5 mm	PUR / Brass	24 AC/DC	-25...80	IP 67	yellow	36	E11435



Group 68 · Jumper , plug: M12, 3-pole, valve plug: Housing C, 4-pole, 3-wire, LED · Wiring diagram no. 6



	0.3 m black PUR cable	3 x 0.5 mm ² , Ø 5 mm	PUR / Brass	24 AC/DC	-25...80	IP 65	yellow	37	E11426
	0.6 m black PUR cable	3 x 0.5 mm ² , Ø 5 mm	PUR / Brass	24 AC/DC	-25...80	IP 65	yellow	37	E11427
	1 m black PUR cable	3 x 0.5 mm ² , Ø 5 mm	PUR / Brass	24 AC/DC	-25...80	IP 65	yellow	37	E11428
	2 m black PUR cable	3 x 0.5 mm ² , Ø 5 mm	PUR / Brass	24 AC/DC	-25...80	IP 65	yellow	37	E11429
	5 m black PUR cable	3 x 0.5 mm ² , Ø 5 mm	PUR / Brass	24 AC/DC	-25...80	IP 65	yellow	37	E11430

Group 69 · Jumper , plug: M12, 3-pole, valve plug: Housing C (industrial standard), 4-pole, 3-wire, LED · Wiring diagram no. 6

	0.3 m black PUR cable	3 x 0.5 mm ² , Ø 5 mm	PUR / Brass	24 AC/DC	-25...80	IP 67	yellow	38	E11436
	0.6 m black PUR cable	3 x 0.5 mm ² , Ø 5 mm	PUR / Brass	24 AC/DC	-25...80	IP 67	yellow	38	E11437
	1 m black PUR cable	3 x 0.5 mm ² , Ø 5 mm	PUR / Brass	24 AC/DC	-25...80	IP 67	yellow	38	E11438
	2 m black PUR cable	3 x 0.5 mm ² , Ø 5 mm	PUR / Brass	24 AC/DC	-25...80	IP 67	yellow	38	E11439
	5 m black PUR cable	3 x 0.5 mm ² , Ø 5 mm	PUR / Brass	24 AC/DC	-25...80	IP 67	yellow	38	E11440

Jumpers weld slag resistant

Type	Cable	Wire specification	Material housing / nut	U [V]	T _a [°C]	Protection	LEDs	Drawing no.	Order no.
Group 118 · Jumper , plug: M12, 4-pole, socket: M12, 5-pole, 4-wire · Wiring diagram no. 3									
	0.3 m grey PUR cable	4 x 0.34 mm ² , Ø 4.9 mm	TPU / Brass	250 AC 300 DC	-25...90	IP 65 / IP 67 / IP 68 / IP 69K	–	39	EVW036
	0.5 m grey PUR cable	4 x 0.34 mm ² , Ø 4.9 mm	TPU / Brass	250 AC 300 DC	-25...90	IP 65 / IP 67 / IP 68 / IP 69K	–	39	EVW022
	1 m grey PUR cable	4 x 0.34 mm ² , Ø 4.9 mm	TPU / Brass	250 AC 300 DC	-25...90	IP 65 / IP 67 / IP 68 / IP 69K	–	39	EVW030
	2 m grey PUR cable	4 x 0.34 mm ² , Ø 4.9 mm	TPU / Brass	250 AC 300 DC	-25...90	IP 65 / IP 67 / IP 68 / IP 69K	–	39	EVW031
	5 m grey PUR cable	4 x 0.34 mm ² , Ø 4.9 mm	TPU / Brass	250 AC 300 DC	-25...90	IP 65 / IP 67 / IP 68 / IP 69K	–	39	EVW034
	0.3 m grey PUR cable	4 x 0.34 mm ² , Ø 4.9 mm	TPU / Brass	250 AC 300 DC	-25...90	IP 65 / IP 67 / IP 68 / IP 69K	–	40	EVW037
	0.5 m grey PUR cable	4 x 0.34 mm ² , Ø 4.9 mm	TPU / Brass	250 AC 300 DC	-25...90	IP 65 / IP 67 / IP 68 / IP 69K	–	40	EVW023
	1 m grey PUR cable	4 x 0.34 mm ² , Ø 4.9 mm	TPU / Brass	250 AC 300 DC	-25...90	IP 65 / IP 67 / IP 68 / IP 69K	–	40	EVW024
	2 m grey PUR cable	4 x 0.34 mm ² , Ø 4.9 mm	TPU / Brass	250 AC 300 DC	-25...90	IP 65 / IP 67 / IP 68 / IP 69K	–	40	EVW025
	5 m grey PUR cable	4 x 0.34 mm ² , Ø 4.9 mm	TPU / Brass	250 AC 300 DC	-25...90	IP 65 / IP 67 / IP 68 / IP 69K	–	40	EVW028
Group 119 · Jumper , plug: M12, 5-pole, socket: M12, 5-pole, 4-wire · Wiring diagram no. 5									
	0.3 m grey PUR cable	5 x 0.34 mm ² , Ø 5.1 mm	TPU / Brass	60 AC 60 DC	-25...90	IP 65 / IP 67 / IP 68 / IP 69K	–	31	EVW054
	0.6 m grey PUR cable	5 x 0.34 mm ² , Ø 5.1 mm	TPU / Brass	60 AC 60 DC	-25...90	IP 65 / IP 67 / IP 68 / IP 69K	–	31	EVW055
	1 m grey PUR cable	5 x 0.34 mm ² , Ø 5.1 mm	TPU / Brass	60 AC 60 DC	-25...90	IP 65 / IP 67 / IP 68 / IP 69K	–	31	EVW056
	2 m grey PUR cable	5 x 0.34 mm ² , Ø 5.1 mm	TPU / Brass	60 AC 60 DC	-25...90	IP 65 / IP 67 / IP 68 / IP 69K	–	31	EVW057



Type	Cable	Wire specification	Material housing / nut	U [V]	T _a [°C]	Protection	LEDs	Drawing no.	Order no.
Group 119 · Jumper , plug: M12, 5-pole, socket: M12, 5-pole, 4-wire · Wiring diagram no. 5									
	5 m grey PUR cable	5 x 0.34 mm ² , Ø 5.1 mm	TPU / Brass	60 AC 60 DC	-25...90	IP 65 / IP 67 / IP 68 / IP 69K	-	31	EVW058
	10 m grey PUR cable	5 x 0.34 mm ² , Ø 5.1 mm	TPU / Brass	60 AC 60 DC	-25...90	IP 65 / IP 67 / IP 68 / IP 69K	-	31	EVW059
	0.3 m grey PUR cable	5 x 0.34 mm ² , Ø 5.1 mm	TPU / Brass	60 AC 60 DC	-25...90	IP 65 / IP 67 / IP 68 / IP 69K	-	32	EVW048
	0.6 m grey PUR cable	5 x 0.34 mm ² , Ø 5.1 mm	TPU / Brass	60 AC 60 DC	-25...90	IP 65 / IP 67 / IP 68 / IP 69K	-	32	EVW049
	1 m grey PUR cable	5 x 0.34 mm ² , Ø 5.1 mm	TPU / Brass	60 AC 60 DC	-25...90	IP 65 / IP 67 / IP 68 / IP 69K	-	32	EVW050
	2 m grey PUR cable	5 x 0.34 mm ² , Ø 5.1 mm	TPU / Brass	60 AC 60 DC	-25...90	IP 65 / IP 67 / IP 68 / IP 69K	-	32	EVW051
	5 m grey PUR cable	5 x 0.34 mm ² , Ø 5.1 mm	TPU / Brass	60 AC 60 DC	-25...90	IP 65 / IP 67 / IP 68 / IP 69K	-	32	EVW052
	10 m grey PUR cable	5 x 0.34 mm ² , Ø 5.1 mm	TPU / Brass	60 AC 60 DC	-25...90	IP 65 / IP 67 / IP 68 / IP 69K	-	32	EVW053

Jumpers for hygienic and wet areas

Type	Cable	Wire specification	Material housing / nut	U [V]	T _a [°C]	Protection	LEDs	Drawing no.	Order no.
Group 137 · Jumper , plug: M8, 3-pole, socket: M8, 3-pole, 3-wire · Wiring diagram no. 1									
	0.3 m orange PVC cable	3 x 0.34 mm ² , Ø 4.9 mm	PVC / stainless steel 316L / 1.4404	50 AC 60 DC	-25...80	IP 65 / IP 67 / IP 68 / IP 69K	-	41	EVT142
	0.6 m orange PVC cable	3 x 0.34 mm ² , Ø 4.9 mm	PVC / stainless steel 316L / 1.4404	50 AC 60 DC	-25...80	IP 65 / IP 67 / IP 68 / IP 69K	-	41	EVT143
	1 m orange PVC cable	3 x 0.34 mm ² , Ø 4.9 mm	PVC / stainless steel 316L / 1.4404	50 AC 60 DC	-25...80	IP 65 / IP 67 / IP 68 / IP 69K	-	41	EVT144
	2 m orange PVC cable	3 x 0.34 mm ² , Ø 4.9 mm	PVC / stainless steel 316L / 1.4404	50 AC 60 DC	-25...80	IP 65 / IP 67 / IP 68 / IP 69K	-	41	EVT145
	5 m orange PVC cable	3 x 0.34 mm ² , Ø 4.9 mm	PVC / stainless steel 316L / 1.4404	50 AC 60 DC	-25...80	IP 65 / IP 67 / IP 68 / IP 69K	-	41	EVT146

Type	Cable	Wire specification	Material housing / nut	U [V]	T _a [°C]	Protection	LEDs	Drawing no.	Order no.
------	-------	--------------------	------------------------	-------	---------------------	------------	------	-------------	-----------

Group 137 · Jumper , plug: M8, 3-pole, socket: M8, 3-pole, 3-wire · Wiring diagram no. 1



	10 m orange PVC cable	3 x 0.34 mm ² , Ø 4.9 mm	PVC / stainless steel 316L / 1.4404	50 AC 60 DC	-25...80	IP 65 / IP 67 / IP 68 / IP 69K	-	41	EVT147
	0.3 m orange PVC cable	3 x 0.34 mm ² , Ø 4.9 mm	PVC / stainless steel 316L / 1.4404	50 AC 60 DC	-25...80	IP 65 / IP 67 / IP 68 / IP 69K	-	42	EVT148
	0.6 m orange PVC cable	3 x 0.34 mm ² , Ø 4.9 mm	PVC / stainless steel 316L / 1.4404	50 AC 60 DC	-25...80	IP 65 / IP 67 / IP 68 / IP 69K	-	42	EVT149
	1 m orange PVC cable	3 x 0.34 mm ² , Ø 4.9 mm	PVC / stainless steel 316L / 1.4404	50 AC 60 DC	-25...80	IP 65 / IP 67 / IP 68 / IP 69K	-	42	EVT150
	2 m orange PVC cable	3 x 0.34 mm ² , Ø 4.9 mm	PVC / stainless steel 316L / 1.4404	50 AC 60 DC	-25...80	IP 65 / IP 67 / IP 68 / IP 69K	-	42	EVT151
	5 m orange PVC cable	3 x 0.34 mm ² , Ø 4.9 mm	PVC / stainless steel 316L / 1.4404	50 AC 60 DC	-25...80	IP 65 / IP 67 / IP 68 / IP 69K	-	42	EVT152
	10 m orange PVC cable	3 x 0.34 mm ² , Ø 4.9 mm	PVC / stainless steel 316L / 1.4404	50 AC 60 DC	-25...80	IP 65 / IP 67 / IP 68 / IP 69K	-	42	EVT153

Group 139 · Jumper , plug: M8, 3-pole, socket: M8, 3-pole, 3-wire, LED, PNP · Wiring diagram no. 2

	0.3 m orange PVC cable	3 x 0.34 mm ² , Ø 4.9 mm	PVC / stainless steel 316L / 1.4404	10...36 DC	-25...80	IP 65 / IP 67 / IP 68 / IP 69K	green / yellow	43	EVT154
	0.6 m orange PVC cable	3 x 0.34 mm ² , Ø 4.9 mm	PVC / stainless steel 316L / 1.4404	10...36 DC	-25...80	IP 65 / IP 67 / IP 68 / IP 69K	green / yellow	43	EVT155
	1 m orange PVC cable	3 x 0.34 mm ² , Ø 4.9 mm	PVC / stainless steel 316L / 1.4404	10...36 DC	-25...80	IP 65 / IP 67 / IP 68 / IP 69K	green / yellow	43	EVT156
	2 m orange PVC cable	3 x 0.34 mm ² , Ø 4.9 mm	PVC / stainless steel 316L / 1.4404	10...36 DC	-25...80	IP 65 / IP 67 / IP 68 / IP 69K	green / yellow	43	EVT157
	5 m orange PVC cable	3 x 0.34 mm ² , Ø 4.9 mm	PVC / stainless steel 316L / 1.4404	10...36 DC	-25...80	IP 65 / IP 67 / IP 68 / IP 69K	green / yellow	43	EVT158
	10 m orange PVC cable	3 x 0.34 mm ² , Ø 4.9 mm	PVC / stainless steel 316L / 1.4404	10...36 DC	-25...80	IP 65 / IP 67 / IP 68 / IP 69K	green / yellow	43	EVT159

Group 141 · Jumper , plug: M8, 3-pole, socket: M8, 3-pole, 3-wire · Wiring diagram no. 1

	0.3 m orange PVC cable	3 x 0.34 mm ² , Ø 4.9 mm	PVC / stainless steel 316L / 1.4404	50 AC 60 DC	-25...80	IP 65 / IP 67 / IP 68 / IP 69K	-	44	EVT160
---	------------------------	-------------------------------------	-------------------------------------	----------------	----------	--------------------------------	---	----	---------------



Type	Cable	Wire specification	Material housing / nut	U [V]	T _a [°C]	Protection	LEDs	Drawing no.	Order no.
Group 141 · Jumper , plug: M8, 3-pole, socket: M8, 3-pole, 3-wire · Wiring diagram no. 1									
	0.6 m orange PVC cable	3 x 0.34 mm ² , Ø 4.9 mm	PVC / stainless steel 316L / 1.4404	50 AC 60 DC	-25...80	IP 65 / IP 67 / IP 68 / IP 69K	-	44	EVT161
	1 m orange PVC cable	3 x 0.34 mm ² , Ø 4.9 mm	PVC / stainless steel 316L / 1.4404	50 AC 60 DC	-25...80	IP 65 / IP 67 / IP 68 / IP 69K	-	44	EVT162
	2 m orange PVC cable	3 x 0.34 mm ² , Ø 4.9 mm	PVC / stainless steel 316L / 1.4404	50 AC 60 DC	-25...80	IP 65 / IP 67 / IP 68 / IP 69K	-	44	EVT163
	5 m orange PVC cable	3 x 0.34 mm ² , Ø 4.9 mm	PVC / stainless steel 316L / 1.4404	50 AC 60 DC	-25...80	IP 65 / IP 67 / IP 68 / IP 69K	-	44	EVT164
	10 m orange PVC cable	3 x 0.34 mm ² , Ø 4.9 mm	PVC / stainless steel 316L / 1.4404	50 AC 60 DC	-25...80	IP 65 / IP 67 / IP 68 / IP 69K	-	44	EVT165
	0.3 m orange PVC cable	3 x 0.34 mm ² , Ø 4.9 mm	PVC / stainless steel 316L / 1.4404	50 AC 60 DC	-25...80	IP 65 / IP 67 / IP 68 / IP 69K	-	45	EVT166
	0.6 m orange PVC cable	3 x 0.34 mm ² , Ø 4.9 mm	PVC / stainless steel 316L / 1.4404	50 AC 60 DC	-25...80	IP 65 / IP 67 / IP 68 / IP 69K	-	45	EVT167
	1 m orange PVC cable	3 x 0.34 mm ² , Ø 4.9 mm	PVC / stainless steel 316L / 1.4404	50 AC 60 DC	-25...80	IP 65 / IP 67 / IP 68 / IP 69K	-	45	EVT168
	2 m orange PVC cable	3 x 0.34 mm ² , Ø 4.9 mm	PVC / stainless steel 316L / 1.4404	50 AC 60 DC	-25...80	IP 65 / IP 67 / IP 68 / IP 69K	-	45	EVT169
	5 m orange PVC cable	3 x 0.34 mm ² , Ø 4.9 mm	PVC / stainless steel 316L / 1.4404	50 AC 60 DC	-25...80	IP 65 / IP 67 / IP 68 / IP 69K	-	45	EVT170
	10 m orange PVC cable	3 x 0.34 mm ² , Ø 4.9 mm	PVC / stainless steel 316L / 1.4404	50 AC 60 DC	-25...80	IP 65 / IP 67 / IP 68 / IP 69K	-	45	EVT171
Group 142 · Jumper , plug: M8, 3-pole, socket: M8, 3-pole, 3-wire, LED, PNP · Wiring diagram no. 2									
	0.3 m orange PVC cable	3 x 0.34 mm ² , Ø 4.9 mm	PVC / stainless steel 316L / 1.4404	10...36 DC	-25...80	IP 65 / IP 67 / IP 68 / IP 69K	green / yellow	46	EVT172
	0.6 m orange PVC cable	3 x 0.34 mm ² , Ø 4.9 mm	PVC / stainless steel 316L / 1.4404	10...36 DC	-25...80	IP 65 / IP 67 / IP 68 / IP 69K	green / yellow	46	EVT173
	1 m orange PVC cable	3 x 0.34 mm ² , Ø 4.9 mm	PVC / stainless steel 316L / 1.4404	10...36 DC	-25...80	IP 65 / IP 67 / IP 68 / IP 69K	green / yellow	46	EVT174
	2 m orange PVC cable	3 x 0.34 mm ² , Ø 4.9 mm	PVC / stainless steel 316L / 1.4404	10...36 DC	-25...80	IP 65 / IP 67 / IP 68 / IP 69K	green / yellow	46	EVT175

Type	Cable	Wire specification	Material housing / nut	U [V]	T _a [°C]	Protection	LEDs	Drawing no.	Order no.
------	-------	--------------------	------------------------	-------	---------------------	------------	------	-------------	-----------

Group 142 · Jumper , plug: M8, 3-pole, socket: M8, 3-pole, 3-wire, LED, PNP · Wiring diagram no. 2





	5 m orange PVC cable	3 x 0.34 mm ² , Ø 4.9 mm	PVC / stainless steel 316L / 1.4404	10...36 DC	-25...80	IP 65 / IP 67 / IP 68 / IP 69K	green / yellow	46	EVT176
	10 m orange PVC cable	3 x 0.34 mm ² , Ø 4.9 mm	PVC / stainless steel 316L / 1.4404	10...36 DC	-25...80	IP 65 / IP 67 / IP 68 / IP 69K	green / yellow	46	EVT177



Group 143 · Jumper , plug: M8, 3-pole, socket: M8, 4-pole, 3-wire · Wiring diagram no. 1

	0.3 m orange PVC cable	3 x 0.34 mm ² , Ø 4.9 mm	PVC / stainless steel 316L / 1.4404	50 AC 60 DC	-25...80	IP 65 / IP 67 / IP 68 / IP 69K	–	47	EVT279
	0.6 m orange PVC cable	3 x 0.34 mm ² , Ø 4.9 mm	PVC / stainless steel 316L / 1.4404	50 AC 60 DC	-25...80	IP 65 / IP 67 / IP 68 / IP 69K	–	47	EVT280
	1 m orange PVC cable	3 x 0.34 mm ² , Ø 4.9 mm	PVC / stainless steel 316L / 1.4404	50 AC 60 DC	-25...80	IP 65 / IP 67 / IP 68 / IP 69K	–	47	EVT281
	2 m orange PVC cable	3 x 0.34 mm ² , Ø 4.9 mm	PVC / stainless steel 316L / 1.4404	50 AC 60 DC	-25...80	IP 65 / IP 67 / IP 68 / IP 69K	–	47	EVT203
	5 m orange PVC cable	3 x 0.34 mm ² , Ø 4.9 mm	PVC / stainless steel 316L / 1.4404	50 AC 60 DC	-25...80	IP 65 / IP 67 / IP 68 / IP 69K	–	47	EVT204
	0.3 m orange PVC cable	3 x 0.34 mm ² , Ø 4.9 mm	PVC / stainless steel 316L / 1.4404	50 AC 60 DC	-25...80	IP 65 / IP 67 / IP 68 / IP 69K	–	48	EVT283
	0.6 m orange PVC cable	3 x 0.34 mm ² , Ø 4.9 mm	PVC / stainless steel 316L / 1.4404	50 AC 60 DC	-25...80	IP 65 / IP 67 / IP 68 / IP 69K	–	48	EVT284
	1 m orange PVC cable	3 x 0.34 mm ² , Ø 4.9 mm	PVC / stainless steel 316L / 1.4404	50 AC 60 DC	-25...80	IP 65 / IP 67 / IP 68 / IP 69K	–	48	EVT285
	2 m orange PVC cable	3 x 0.34 mm ² , Ø 4.9 mm	PVC / stainless steel 316L / 1.4404	50 AC 60 DC	-25...80	IP 65 / IP 67 / IP 68 / IP 69K	–	48	EVT211
	5 m orange PVC cable	3 x 0.34 mm ² , Ø 4.9 mm	PVC / stainless steel 316L / 1.4404	50 AC 60 DC	-25...80	IP 65 / IP 67 / IP 68 / IP 69K	–	48	EVT286

Group 144 · Jumper , plug: M8, 3-pole, socket: M12, 5-pole, 3-wire · Wiring diagram no. 1

	0.3 m orange PVC cable	3 x 0.34 mm ² , Ø 4.9 mm	PVC / stainless steel 316L / 1.4404	50 AC 60 DC	-25...80	IP 65 / IP 67 / IP 68 / IP 69K	–	49	EVT260
	0.6 m orange PVC cable	3 x 0.34 mm ² , Ø 4.9 mm	PVC / stainless steel 316L / 1.4404	50 AC 60 DC	-25...80	IP 65 / IP 67 / IP 68 / IP 69K	–	49	EVT261



Type	Cable	Wire specification	Material housing / nut	U [V]	T _a [°C]	Protection	LEDs	Drawing no.	Order no.
Group 144 · Jumper , plug: M8, 3-pole, socket: M12, 5-pole, 3-wire · Wiring diagram no. 1									
	1 m orange PVC cable	3 x 0.34 mm ² , Ø 4.9 mm	PVC / stainless steel 316L / 1.4404	50 AC 60 DC	-25...80	IP 65 / IP 67 / IP 68 / IP 69K	–	49	EVT262
	2 m orange PVC cable	3 x 0.34 mm ² , Ø 4.9 mm	PVC / stainless steel 316L / 1.4404	50 AC 60 DC	-25...80	IP 65 / IP 67 / IP 68 / IP 69K	–	49	EVT263
	0.3 m orange PVC cable	3 x 0.34 mm ² , Ø 4.9 mm	PVC / stainless steel 316L / 1.4404	50 AC 60 DC	-25...80	IP 65 / IP 67 / IP 68 / IP 69K	–	50	EVT265
	0.6 m orange PVC cable	3 x 0.34 mm ² , Ø 4.9 mm	PVC / stainless steel 316L / 1.4404	50 AC 60 DC	-25...80	IP 65 / IP 67 / IP 68 / IP 69K	–	50	EVT266
	1 m orange PVC cable	3 x 0.34 mm ² , Ø 4.9 mm	PVC / stainless steel 316L / 1.4404	50 AC 60 DC	-25...80	IP 65 / IP 67 / IP 68 / IP 69K	–	50	EVT267
	2 m orange PVC cable	3 x 0.34 mm ² , Ø 4.9 mm	PVC / stainless steel 316L / 1.4404	50 AC 60 DC	-25...80	IP 65 / IP 67 / IP 68 / IP 69K	–	50	EVT268
	5 m orange PVC cable	3 x 0.34 mm ² , Ø 4.9 mm	PVC / stainless steel 316L / 1.4404	50 AC 60 DC	-25...80	IP 65 / IP 67 / IP 68 / IP 69K	–	50	EVT269
Group 145 · Jumper , plug: M8, 4-pole, socket: M8, 4-pole, 4-wire · Wiring diagram no. 3									
	0.3 m orange PVC cable	4 x 0.34 mm ² , Ø 4.9 mm	PVC / stainless steel 316L / 1.4404	50 AC 60 DC	-25...80	IP 65 / IP 67 / IP 68 / IP 69K	–	51	EVT178
	0.6 m orange PVC cable	4 x 0.34 mm ² , Ø 4.9 mm	PVC / stainless steel 316L / 1.4404	50 AC 60 DC	-25...80	IP 65 / IP 67 / IP 68 / IP 69K	–	51	EVT179
	1 m orange PVC cable	4 x 0.34 mm ² , Ø 4.9 mm	PVC / stainless steel 316L / 1.4404	50 AC 60 DC	-25...80	IP 65 / IP 67 / IP 68 / IP 69K	–	51	EVT180
	2 m orange PVC cable	4 x 0.34 mm ² , Ø 4.9 mm	PVC / stainless steel 316L / 1.4404	50 AC 60 DC	-25...80	IP 65 / IP 67 / IP 68 / IP 69K	–	51	EVT181
	5 m orange PVC cable	4 x 0.34 mm ² , Ø 4.9 mm	PVC / stainless steel 316L / 1.4404	50 AC 60 DC	-25...80	IP 65 / IP 67 / IP 68 / IP 69K	–	51	EVT182
	10 m orange PVC cable	4 x 0.34 mm ² , Ø 4.9 mm	PVC / stainless steel 316L / 1.4404	50 AC 60 DC	-25...80	IP 65 / IP 67 / IP 68 / IP 69K	–	51	EVT183
	0.3 m orange PVC cable	4 x 0.34 mm ² , Ø 4.9 mm	PVC / stainless steel 316L / 1.4404	50 AC 60 DC	-25...80	IP 65 / IP 67 / IP 68 / IP 69K	–	52	EVT184
	0.6 m orange PVC cable	4 x 0.34 mm ² , Ø 4.9 mm	PVC / stainless steel 316L / 1.4404	50 AC 60 DC	-25...80	IP 65 / IP 67 / IP 68 / IP 69K	–	52	EVT185

Type	Cable	Wire specification	Material housing / nut	U [V]	T _a [°C]	Protection	LEDs	Drawing no.	Order no.
Group 145 · Jumper , plug: M8, 4-pole, socket: M8, 4-pole, 4-wire · Wiring diagram no. 3									
	1 m orange PVC cable	4 x 0.34 mm ² , Ø 4.9 mm	PVC / stainless steel 316L / 1.4404	50 AC 60 DC	-25...80	IP 65 / IP 67 / IP 68 / IP 69K	-	52	EVT186
	2 m orange PVC cable	4 x 0.34 mm ² , Ø 4.9 mm	PVC / stainless steel 316L / 1.4404	50 AC 60 DC	-25...80	IP 65 / IP 67 / IP 68 / IP 69K	-	52	EVT187
	5 m orange PVC cable	4 x 0.34 mm ² , Ø 4.9 mm	PVC / stainless steel 316L / 1.4404	50 AC 60 DC	-25...80	IP 65 / IP 67 / IP 68 / IP 69K	-	52	EVT188
	10 m orange PVC cable	4 x 0.34 mm ² , Ø 4.9 mm	PVC / stainless steel 316L / 1.4404	50 AC 60 DC	-25...80	IP 65 / IP 67 / IP 68 / IP 69K	-	52	EVT189
	0.3 m orange PVC cable	4 x 0.34 mm ² , Ø 4.9 mm	PVC / stainless steel 316L / 1.4404	50 AC 60 DC	-25...80	IP 65 / IP 67 / IP 68 / IP 69K	-	53	EVT190
	0.6 m orange PVC cable	4 x 0.34 mm ² , Ø 4.9 mm	PVC / stainless steel 316L / 1.4404	50 AC 60 DC	-25...80	IP 65 / IP 67 / IP 68 / IP 69K	-	53	EVT191
	1 m orange PVC cable	4 x 0.34 mm ² , Ø 4.9 mm	PVC / stainless steel 316L / 1.4404	50 AC 60 DC	-25...80	IP 65 / IP 67 / IP 68 / IP 69K	-	53	EVT192
	2 m orange PVC cable	4 x 0.34 mm ² , Ø 4.9 mm	PVC / stainless steel 316L / 1.4404	50 AC 60 DC	-25...80	IP 65 / IP 67 / IP 68 / IP 69K	-	53	EVT193
	5 m orange PVC cable	4 x 0.34 mm ² , Ø 4.9 mm	PVC / stainless steel 316L / 1.4404	50 AC 60 DC	-25...80	IP 65 / IP 67 / IP 68 / IP 69K	-	53	EVT194
	10 m orange PVC cable	4 x 0.34 mm ² , Ø 4.9 mm	PVC / stainless steel 316L / 1.4404	50 AC 60 DC	-25...80	IP 65 / IP 67 / IP 68 / IP 69K	-	53	EVT195
	0.3 m orange PVC cable	4 x 0.34 mm ² , Ø 4.9 mm	PVC / stainless steel 316L / 1.4404	50 AC 60 DC	-25...80	IP 65 / IP 67 / IP 68 / IP 69K	-	54	EVT196
	0.6 m orange PVC cable	4 x 0.34 mm ² , Ø 4.9 mm	PVC / stainless steel 316L / 1.4404	50 AC 60 DC	-25...80	IP 65 / IP 67 / IP 68 / IP 69K	-	54	EVT197
	1 m orange PVC cable	4 x 0.34 mm ² , Ø 4.9 mm	PVC / stainless steel 316L / 1.4404	50 AC 60 DC	-25...80	IP 65 / IP 67 / IP 68 / IP 69K	-	54	EVT198
	2 m orange PVC cable	4 x 0.34 mm ² , Ø 4.9 mm	PVC / stainless steel 316L / 1.4404	50 AC 60 DC	-25...80	IP 65 / IP 67 / IP 68 / IP 69K	-	54	EVT199
	5 m orange PVC cable	4 x 0.34 mm ² , Ø 4.9 mm	PVC / stainless steel 316L / 1.4404	50 AC 60 DC	-25...80	IP 65 / IP 67 / IP 68 / IP 69K	-	54	EVT200

Type	Cable	Wire specification	Material housing / nut	U [V]	T _a [°C]	Protection	LEDs	Drawing no.	Order no.
Group 145 · Jumper , plug: M8, 4-pole, socket: M8, 4-pole, 4-wire · Wiring diagram no. 3									
	10 m orange PVC cable	4 x 0.34 mm ² , Ø 4.9 mm	PVC / stainless steel 316L / 1.4404	50 AC 60 DC	-25...80	IP 65 / IP 67 / IP 68 / IP 69K	-	54	EVT201

Jumpers for hygienic and wet areas

Type	Cable	Wire specification	Material housing / nut	U [V]	T _a [°C]	Protection	LEDs	Drawing no.	Order no.
Group 146 · Jumper , plug: M12, 3-pole, socket: M8, 3-pole, 3-wire · Wiring diagram no. 1									

	0.3 m orange PVC cable	3 x 0.34 mm ² , Ø 4.9 mm	PVC / stainless steel 316L / 1.4404	50 AC 60 DC	-25...80	IP 65 / IP 67 / IP 68 / IP 69K	-	55	EVT236
	0.6 m orange PVC cable	3 x 0.34 mm ² , Ø 4.9 mm	PVC / stainless steel 316L / 1.4404	50 AC 60 DC	-25...80	IP 65 / IP 67 / IP 68 / IP 69K	-	55	EVT237
	1 m orange PVC cable	3 x 0.34 mm ² , Ø 4.9 mm	PVC / stainless steel 316L / 1.4404	50 AC 60 DC	-25...80	IP 65 / IP 67 / IP 68 / IP 69K	-	55	EVT238
	2 m orange PVC cable	3 x 0.34 mm ² , Ø 4.9 mm	PVC / stainless steel 316L / 1.4404	50 AC 60 DC	-25...80	IP 65 / IP 67 / IP 68 / IP 69K	-	55	EVT239
	5 m orange PVC cable	3 x 0.34 mm ² , Ø 4.9 mm	PVC / stainless steel 316L / 1.4404	50 AC 60 DC	-25...80	IP 65 / IP 67 / IP 68 / IP 69K	-	55	EVT240
	0.3 m orange PVC cable	3 x 0.34 mm ² , Ø 4.9 mm	PVC / stainless steel 316L / 1.4404	50 AC 60 DC	-25...80	IP 65 / IP 67 / IP 68 / IP 69K	-	56	EVT242
	0.6 m orange PVC cable	3 x 0.34 mm ² , Ø 4.9 mm	PVC / stainless steel 316L / 1.4404	50 AC 60 DC	-25...80	IP 65 / IP 67 / IP 68 / IP 69K	-	56	EVT243
	1 m orange PVC cable	3 x 0.34 mm ² , Ø 4.9 mm	PVC / stainless steel 316L / 1.4404	50 AC 60 DC	-25...80	IP 65 / IP 67 / IP 68 / IP 69K	-	56	EVT244
	2 m orange PVC cable	3 x 0.34 mm ² , Ø 4.9 mm	PVC / stainless steel 316L / 1.4404	50 AC 60 DC	-25...80	IP 65 / IP 67 / IP 68 / IP 69K	-	56	EVT245
	5 m orange PVC cable	3 x 0.34 mm ² , Ø 4.9 mm	PVC / stainless steel 316L / 1.4404	50 AC 60 DC	-25...80	IP 65 / IP 67 / IP 68 / IP 69K	-	56	EVT246

Group 147 · Jumper , plug: M12, 3-pole, socket: M12, 5/4/3-pole, 3-wire · Wiring diagram no. 1

	0.3 m orange PVC cable	3 x 0.34 mm ² , Ø 4.9 mm	PVC / stainless steel 316L / 1.4404	250 AC 300 DC	-25...100	IP 65 / IP 67 / IP 68 / IP 69K	-	57	EVT028
---	------------------------	-------------------------------------	-------------------------------------	------------------	-----------	--------------------------------	---	----	--------

Type	Cable	Wire specification	Material housing / nut	U [V]	T _a [°C]	Protection	LEDs	Drawing no.	Order no.
------	-------	--------------------	------------------------	-------	---------------------	------------	------	-------------	-----------

Group 147 · Jumper , plug: M12, 3-pole, socket: M12, 5/4/3-pole, 3-wire · Wiring diagram no. 1

	0.6 m orange PVC cable	3 x 0.34 mm ² , Ø 4.9 mm	PVC / stainless steel 316L / 1.4404	250 AC 300 DC	-25...100	IP 65 / IP 67 / IP 68 / IP 69K	-	57	EVT029
	1 m orange PVC cable	3 x 0.34 mm ² , Ø 4.9 mm	PVC / stainless steel 316L / 1.4404	250 AC 300 DC	-25...100	IP 65 / IP 67 / IP 68 / IP 69K	-	57	EVT030
	2 m orange PVC cable	3 x 0.34 mm ² , Ø 4.9 mm	PVC / stainless steel 316L / 1.4404	250 AC 300 DC	-25...100	IP 65 / IP 67 / IP 68 / IP 69K	-	57	EVT031
	5 m orange PVC cable	3 x 0.34 mm ² , Ø 4.9 mm	PVC / stainless steel 316L / 1.4404	250 AC 300 DC	-25...100	IP 65 / IP 67 / IP 68 / IP 69K	-	57	EVT032
	10 m orange PVC cable	3 x 0.34 mm ² , Ø 4.9 mm	PVC / stainless steel 316L / 1.4404	250 AC 300 DC	-25...100	IP 65 / IP 67 / IP 68 / IP 69K	-	57	EVT033

	0.3 m orange PVC cable	3 x 0.34 mm ² , Ø 4.9 mm	PVC / stainless steel 316L / 1.4404	250 AC 300 DC	-25...100	IP 65 / IP 67 / IP 68 / IP 69K	-	58	EVT022
	0.6 m orange PVC cable	3 x 0.34 mm ² , Ø 4.9 mm	PVC / stainless steel 316L / 1.4404	250 AC 300 DC	-25...100	IP 65 / IP 67 / IP 68 / IP 69K	-	58	EVT023
	1 m orange PVC cable	3 x 0.34 mm ² , Ø 4.9 mm	PVC / stainless steel 316L / 1.4404	250 AC 300 DC	-25...100	IP 65 / IP 67 / IP 68 / IP 69K	-	58	EVT024
	2 m orange PVC cable	3 x 0.34 mm ² , Ø 4.9 mm	PVC / stainless steel 316L / 1.4404	250 AC 300 DC	-25...100	IP 65 / IP 67 / IP 68 / IP 69K	-	58	EVT025
	5 m orange PVC cable	3 x 0.34 mm ² , Ø 4.9 mm	PVC / stainless steel 316L / 1.4404	250 AC 300 DC	-25...100	IP 65 / IP 67 / IP 68 / IP 69K	-	58	EVT026
	10 m orange PVC cable	3 x 0.34 mm ² , Ø 4.9 mm	PVC / stainless steel 316L / 1.4404	250 AC 300 DC	-25...100	IP 65 / IP 67 / IP 68 / IP 69K	-	58	EVT027

Group 148 · Jumper , plug: M12, 3-pole, socket: M12, 5/4/3-pole, 3-wire, LED, PNP · Wiring diagram no. 2



	0.3 m orange PVC cable	3 x 0.34 mm ² , Ø 4.9 mm	PVC / stainless steel 316L / 1.4404	10...36 DC	-25...100	IP 65 / IP 67 / IP 68 / IP 69K	green / yellow	59	EVT034
	0.6 m orange PVC cable	3 x 0.34 mm ² , Ø 4.9 mm	PVC / stainless steel 316L / 1.4404	10...36 DC	-25...100	IP 65 / IP 67 / IP 68 / IP 69K	green / yellow	59	EVT035
	1 m orange PVC cable	3 x 0.34 mm ² , Ø 4.9 mm	PVC / stainless steel 316L / 1.4404	10...36 DC	-25...100	IP 65 / IP 67 / IP 68 / IP 69K	green / yellow	59	EVT036
	2 m orange PVC cable	3 x 0.34 mm ² , Ø 4.9 mm	PVC / stainless steel 316L / 1.4404	10...36 DC	-25...100	IP 65 / IP 67 / IP 68 / IP 69K	green / yellow	59	EVT037

You can find wiring diagrams and scale drawings from page 799

Type	Cable	Wire specification	Material housing / nut	U [V]	T _a [°C]	Protection	LEDs	Drawing no.	Order no.
Group 148 · Jumper , plug: M12, 3-pole, socket: M12, 5/4/3-pole, 3-wire, LED, PNP · Wiring diagram no. 2									
	5 m orange PVC cable	3 x 0.34 mm ² , Ø 4.9 mm	PVC / stainless steel 316L / 1.4404	10...36 DC	-25...100	IP 65 / IP 67 / IP 68 / IP 69K	green / yellow	59	EVT038
	10 m orange PVC cable	3 x 0.34 mm ² , Ø 4.9 mm	PVC / stainless steel 316L / 1.4404	10...36 DC	-25...100	IP 65 / IP 67 / IP 68 / IP 69K	green / yellow	59	EVT039
Group 149 · Jumper , plug: M12, 4-pole, socket: M8, 4-pole, 4-wire · Wiring diagram no. 3									
	0.3 m orange PVC cable	4 x 0.34 mm ² , Ø 4.9 mm	PVC / stainless steel 316L / 1.4404	50 AC 60 DC	-25...80	IP 65 / IP 67 / IP 68 / IP 69K	–	60	EVT248
	0.6 m orange PVC cable	4 x 0.34 mm ² , Ø 4.9 mm	PVC / stainless steel 316L / 1.4404	50 AC 60 DC	-25...80	IP 65 / IP 67 / IP 68 / IP 69K	–	60	EVT249
	1 m orange PVC cable	4 x 0.34 mm ² , Ø 4.9 mm	PVC / stainless steel 316L / 1.4404	50 AC 60 DC	-25...80	IP 65 / IP 67 / IP 68 / IP 69K	–	60	EVT250
	5 m orange PVC cable	4 x 0.34 mm ² , Ø 4.9 mm	PVC / stainless steel 316L / 1.4404	50 AC 60 DC	-25...80	IP 65 / IP 67 / IP 68 / IP 69K	–	60	EVT251
	0.3 m orange PVC cable	4 x 0.34 mm ² , Ø 4.9 mm	PVC / stainless steel 316L / 1.4404	50 AC 60 DC	-25...80	IP 65 / IP 67 / IP 68 / IP 69K	–	61	EVT253
	0.6 m orange PVC cable	4 x 0.34 mm ² , Ø 4.9 mm	PVC / stainless steel 316L / 1.4404	50 AC 60 DC	-25...80	IP 65 / IP 67 / IP 68 / IP 69K	–	61	EVT254
	1 m orange PVC cable	4 x 0.34 mm ² , Ø 4.9 mm	PVC / stainless steel 316L / 1.4404	50 AC 60 DC	-25...80	IP 65 / IP 67 / IP 68 / IP 69K	–	61	EVT255
	2 m orange PVC cable	4 x 0.34 mm ² , Ø 4.9 mm	PVC / stainless steel 316L / 1.4404	50 AC 60 DC	-25...80	IP 65 / IP 67 / IP 68 / IP 69K	–	61	EVT256
	5 m orange PVC cable	4 x 0.34 mm ² , Ø 4.9 mm	PVC / stainless steel 316L / 1.4404	50 AC 60 DC	-25...80	IP 65 / IP 67 / IP 68 / IP 69K	–	61	EVT257
Group 150 · Jumper , plug: M12, 4-pole, socket: M12, 5/4-pole, 4-wire · Wiring diagram no. 3									
	0.3 m orange PVC cable	4 x 0.34 mm ² , Ø 4.9 mm	PVC / stainless steel 316L / 1.4404	250 AC 300 DC	-25...100	IP 65 / IP 67 / IP 68 / IP 69K	–	62	EVT046
	0.6 m orange PVC cable	4 x 0.34 mm ² , Ø 4.9 mm	PVC / stainless steel 316L / 1.4404	250 AC 300 DC	-25...100	IP 65 / IP 67 / IP 68 / IP 69K	–	62	EVT047
	1 m orange PVC cable	4 x 0.34 mm ² , Ø 4.9 mm	PVC / stainless steel 316L / 1.4404	250 AC 300 DC	-25...100	IP 65 / IP 67 / IP 68 / IP 69K	–	62	EVT048

Type	Cable	Wire specification	Material housing / nut	U [V]	T _a [°C]	Protection	LEDs	Drawing no.	Order no.
------	-------	--------------------	------------------------	-------	---------------------	------------	------	-------------	-----------

Group 150 · Jumper , plug: M12, 4-pole, socket: M12, 5/4-pole, 4-wire · Wiring diagram no. 3

	2 m orange PVC cable	4 x 0.34 mm ² , Ø 4.9 mm	PVC / stainless steel 316L / 1.4404	250 AC 300 DC	-25...100	IP 65 / IP 67 / IP 68 / IP 69K	-	62	EVT049
	5 m orange PVC cable	4 x 0.34 mm ² , Ø 4.9 mm	PVC / stainless steel 316L / 1.4404	250 AC 300 DC	-25...100	IP 65 / IP 67 / IP 68 / IP 69K	-	62	EVT050
	10 m orange PVC cable	4 x 0.34 mm ² , Ø 4.9 mm	PVC / stainless steel 316L / 1.4404	250 AC 300 DC	-25...100	IP 65 / IP 67 / IP 68 / IP 69K	-	62	EVT051
	0.3 m orange PVC cable	4 x 0.34 mm ² , Ø 4.9 mm	PVC / stainless steel 316L / 1.4404	250 AC 300 DC	-25...100	IP 65 / IP 67 / IP 68 / IP 69K	-	63	EVT040
	0.6 m orange PVC cable	4 x 0.34 mm ² , Ø 4.9 mm	PVC / stainless steel 316L / 1.4404	250 AC 300 DC	-25...100	IP 65 / IP 67 / IP 68 / IP 69K	-	63	EVT041
	1 m orange PVC cable	4 x 0.34 mm ² , Ø 4.9 mm	PVC / stainless steel 316L / 1.4404	250 AC 300 DC	-25...100	IP 65 / IP 67 / IP 68 / IP 69K	-	63	EVT042
	2 m orange PVC cable	4 x 0.34 mm ² , Ø 4.9 mm	PVC / stainless steel 316L / 1.4404	250 AC 300 DC	-25...100	IP 65 / IP 67 / IP 68 / IP 69K	-	63	EVT043
	5 m orange PVC cable	4 x 0.34 mm ² , Ø 4.9 mm	PVC / stainless steel 316L / 1.4404	250 AC 300 DC	-25...100	IP 65 / IP 67 / IP 68 / IP 69K	-	63	EVT044
	10 m orange PVC cable	4 x 0.34 mm ² , Ø 4.9 mm	PVC / stainless steel 316L / 1.4404	250 AC 300 DC	-25...100	IP 65 / IP 67 / IP 68 / IP 69K	-	63	EVT045

Group 151 · Jumper , plug: M12, 4-pole, socket: M12, 5/4-pole, 4-wire, LED, PNP · Wiring diagram no. 4

	0.3 m orange PVC cable	4 x 0.34 mm ² , Ø 4.9 mm	PVC / stainless steel 316L / 1.4404	10...36 DC	-25...100	IP 65 / IP 67 / IP 68 / IP 69K	green / 2 x yellow	64	EVT052
	0.6 m orange PVC cable	4 x 0.34 mm ² , Ø 4.9 mm	PVC / stainless steel 316L / 1.4404	10...36 DC	-25...100	IP 65 / IP 67 / IP 68 / IP 69K	green / 2 x yellow	64	EVT053
	1 m orange PVC cable	4 x 0.34 mm ² , Ø 4.9 mm	PVC / stainless steel 316L / 1.4404	10...36 DC	-25...100	IP 65 / IP 67 / IP 68 / IP 69K	green / 2 x yellow	64	EVT054
	2 m orange PVC cable	4 x 0.34 mm ² , Ø 4.9 mm	PVC / stainless steel 316L / 1.4404	10...36 DC	-25...100	IP 65 / IP 67 / IP 68 / IP 69K	green / 2 x yellow	64	EVT055
	5 m orange PVC cable	4 x 0.34 mm ² , Ø 4.9 mm	PVC / stainless steel 316L / 1.4404	10...36 DC	-25...100	IP 65 / IP 67 / IP 68 / IP 69K	green / 2 x yellow	64	EVT056
	10 m orange PVC cable	4 x 0.34 mm ² , Ø 4.9 mm	PVC / stainless steel 316L / 1.4404	10...36 DC	-25...100	IP 65 / IP 67 / IP 68 / IP 69K	green / 2 x yellow	64	EVT057

You can find wiring diagrams and scale drawings from page 799

Type	Cable	Wire specification	Material housing / nut	U [V]	T _a [°C]	Protection	LEDs	Drawing no.	Order no.
Group 152 · Jumper , plug: M12, 5-pole, socket: M12, 5-pole, 5-wire · Wiring diagram no. 5									
	0.3 m orange PVC cable	5 x 0.34 mm ² , Ø 5.1 mm	PVC / stainless steel 316L / 1.4404	60 AC 60 DC	-25...100	IP 65 / IP 67 / IP 68 / IP 69K	–	65	EVT058
	0.6 m orange PVC cable	5 x 0.34 mm ² , Ø 5.1 mm	PVC / stainless steel 316L / 1.4404	60 AC 60 DC	-25...100	IP 65 / IP 67 / IP 68 / IP 69K	–	65	EVT059
	1 m orange PVC cable	5 x 0.34 mm ² , Ø 5.1 mm	PVC / stainless steel 316L / 1.4404	60 AC 60 DC	-25...100	IP 65 / IP 67 / IP 68 / IP 69K	–	65	EVT060
	2 m orange PVC cable	5 x 0.34 mm ² , Ø 5.1 mm	PVC / stainless steel 316L / 1.4404	60 AC 60 DC	-25...100	IP 65 / IP 67 / IP 68 / IP 69K	–	65	EVT061
	5 m orange PVC cable	5 x 0.34 mm ² , Ø 5.1 mm	PVC / stainless steel 316L / 1.4404	60 AC 60 DC	-25...100	IP 65 / IP 67 / IP 68 / IP 69K	–	65	EVT062
	10 m orange PVC cable	5 x 0.34 mm ² , Ø 5.1 mm	PVC / stainless steel 316L / 1.4404	60 AC 60 DC	-25...100	IP 65 / IP 67 / IP 68 / IP 69K	–	65	EVT063

Jumpers for hazardous areas

Type	Cable	Wire specification	Material housing / nut	U [V]	T _a [°C]	Protection	LEDs	Drawing no.	Order no.
Group 156 · Jumper , plug: M12, 4-pole, socket: M12, 5/4-pole, 4-wire · Wiring diagram no. 3									
	0.3 m black PUR cable	4 x 0.34 mm ² , Ø 4.9 mm	TPU / stainless steel 316L / 1.4404	60 AC 60 DC	-20...60	IP 67	–	66	EVC09A
	0.6 m black PUR cable	4 x 0.34 mm ² , Ø 4.9 mm	TPU / stainless steel 316L / 1.4404	60 AC 60 DC	-20...60	IP 67	–	66	EVC10A
	1 m black PUR cable	4 x 0.34 mm ² , Ø 4.9 mm	TPU / stainless steel 316L / 1.4404	60 AC 60 DC	-20...60	IP 67	–	66	EVC11A
	2 m black PUR cable	4 x 0.34 mm ² , Ø 4.9 mm	TPU / stainless steel 316L / 1.4404	60 AC 60 DC	-20...60	IP 67	–	66	EVC07A
	5 m black PUR cable	4 x 0.34 mm ² , Ø 4.9 mm	TPU / stainless steel 316L / 1.4404	60 AC 60 DC	-20...60	IP 67	–	66	EVC12A
	10 m black PUR cable	4 x 0.34 mm ² , Ø 4.9 mm	TPU / stainless steel 316L / 1.4404	60 AC 60 DC	-20...60	IP 67	–	66	EVC13A

Wiring diagrams

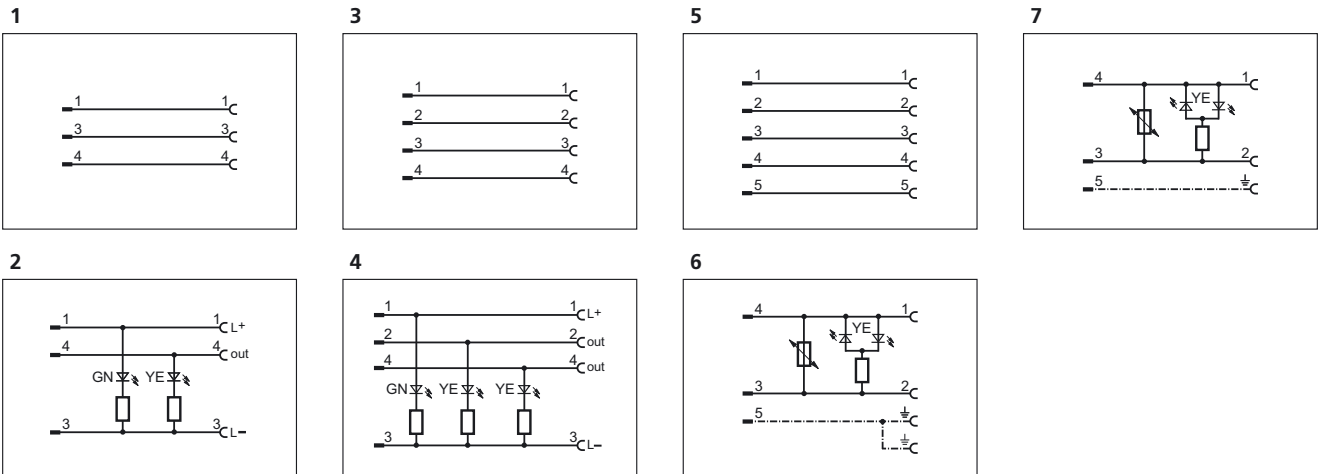

Scale drawings / drawing no. – CAD download: www.ifm.com

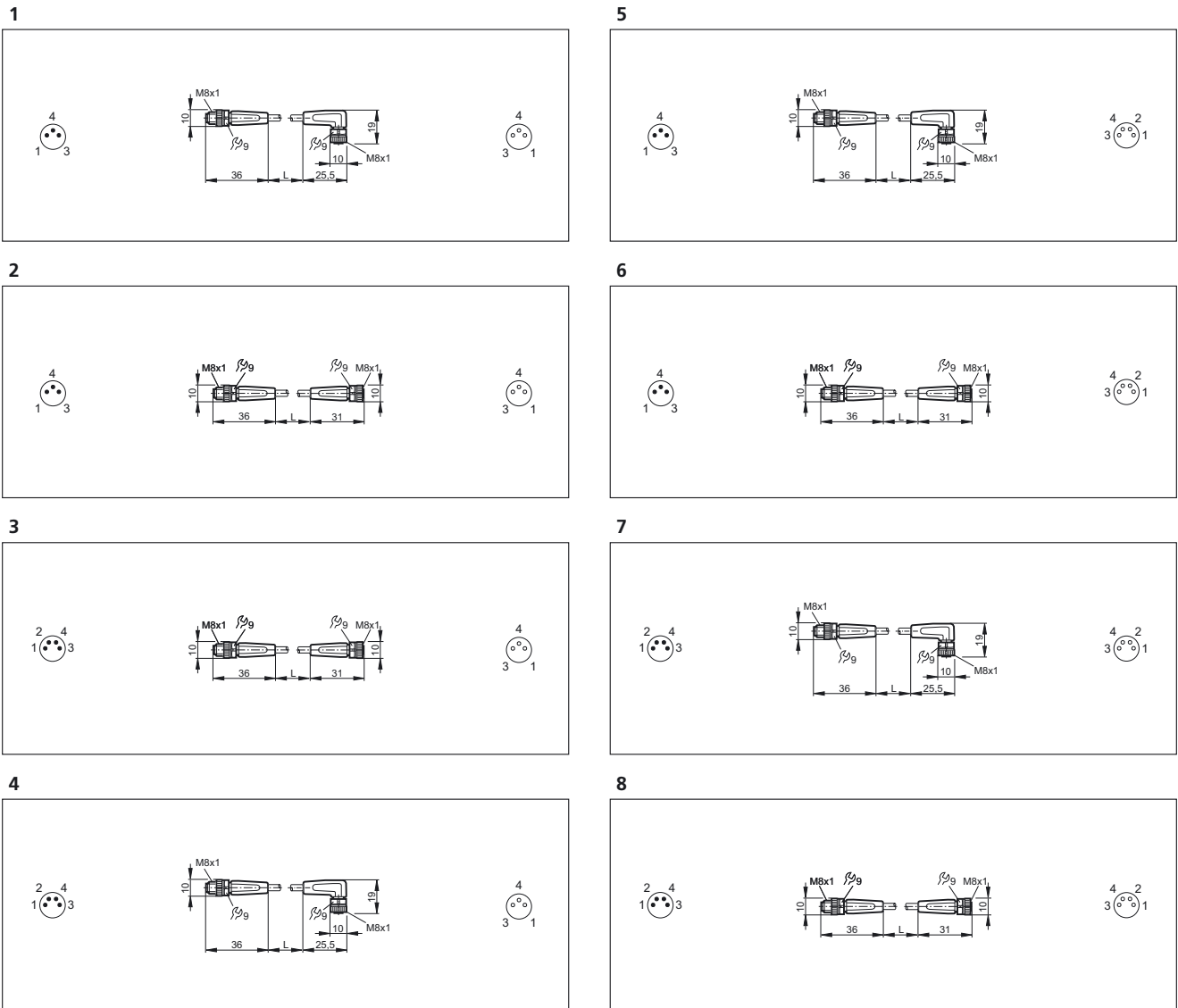

Scale drawings / drawing no. – CAD download: www.ifm.com

9

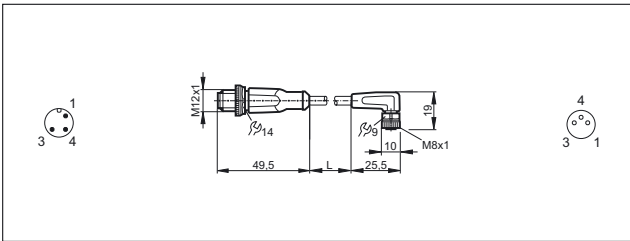

15

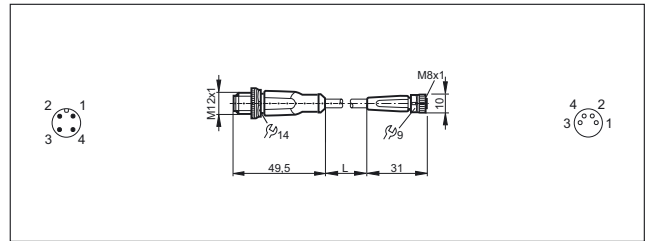

10

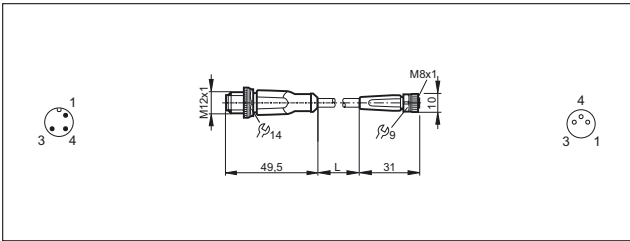

16

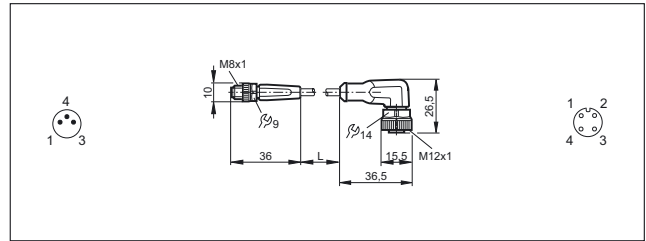

11

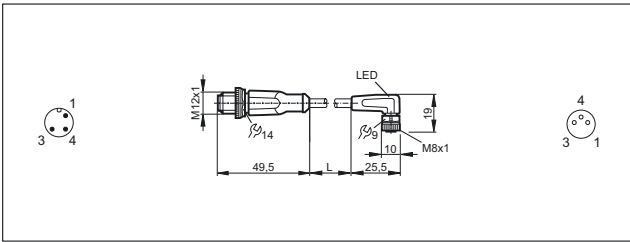

17

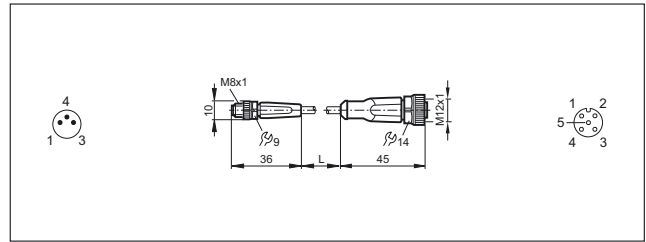

12

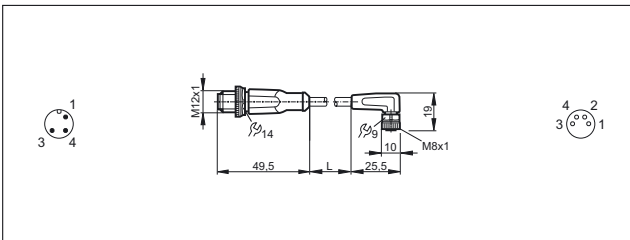

18

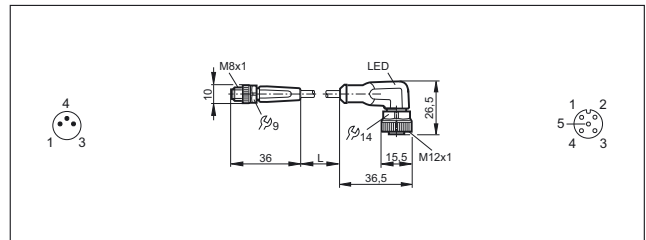

13

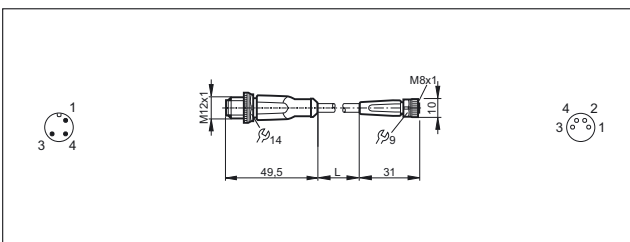

19

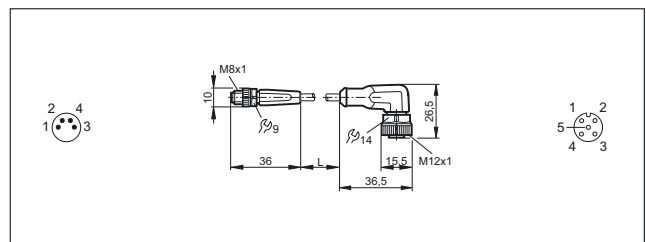

14

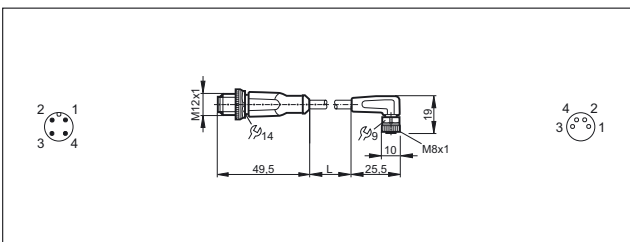

20

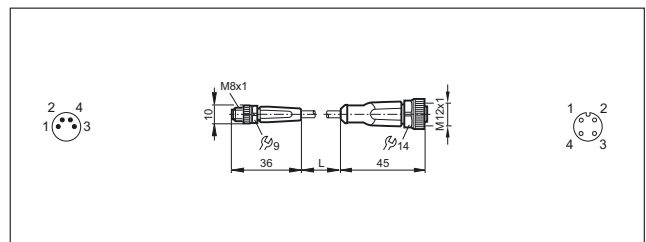

Scale drawings / drawing no. – CAD download: www.ifm.com

21

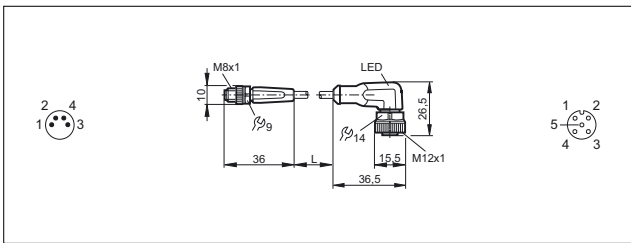

27

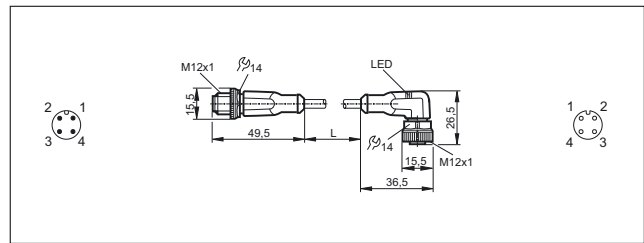

22

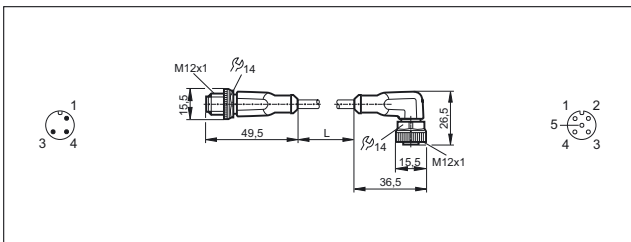

28

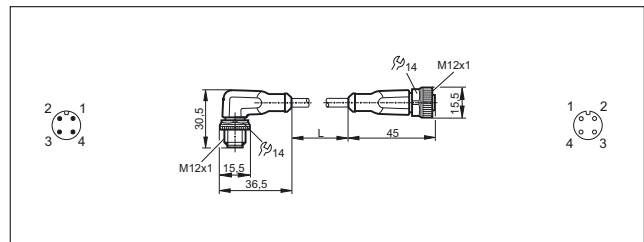

23

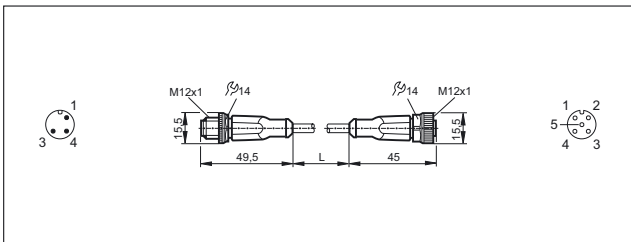

29

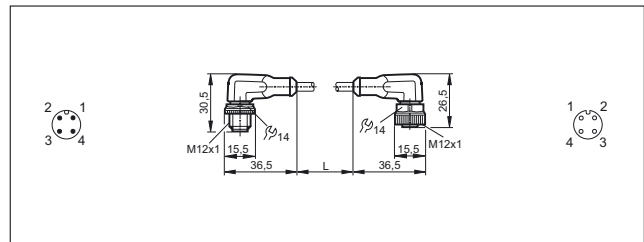

24

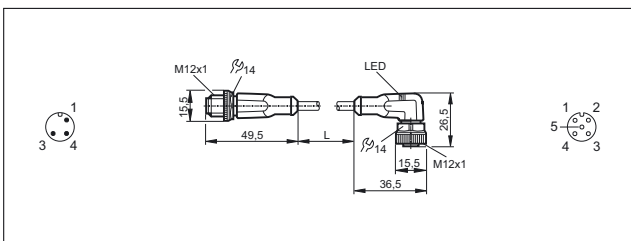

30

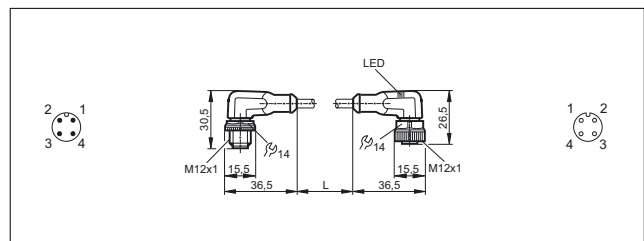

25

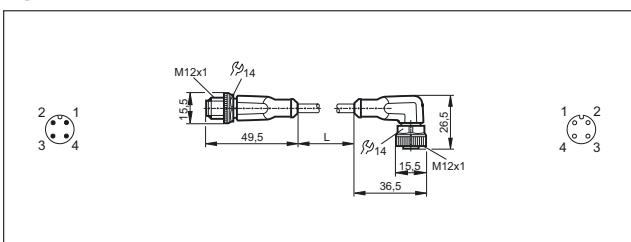

31

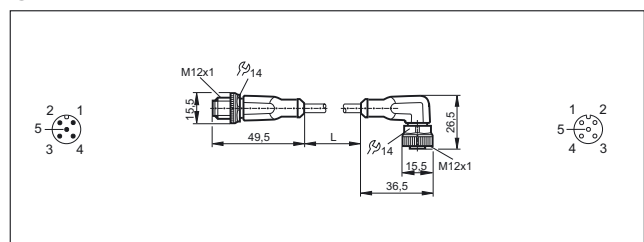

26

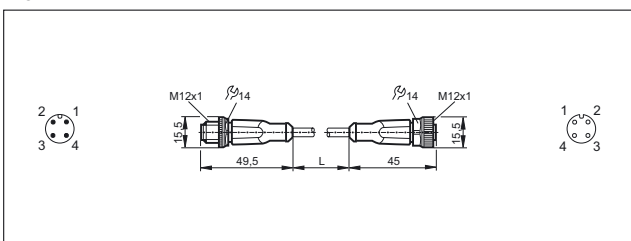

32

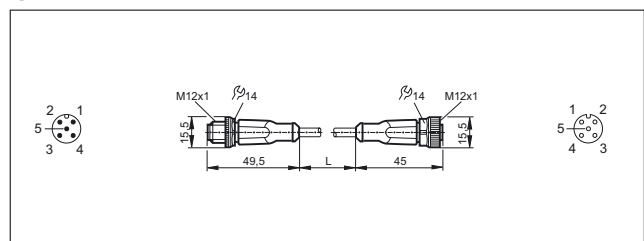

Scale drawings / drawing no. – CAD download: www.ifm.com

33

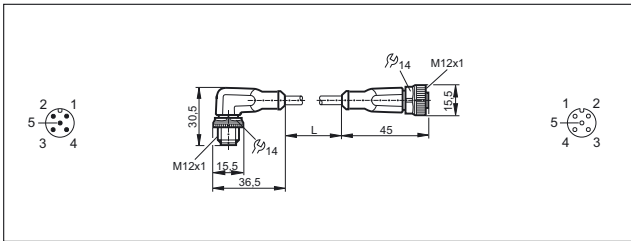

39

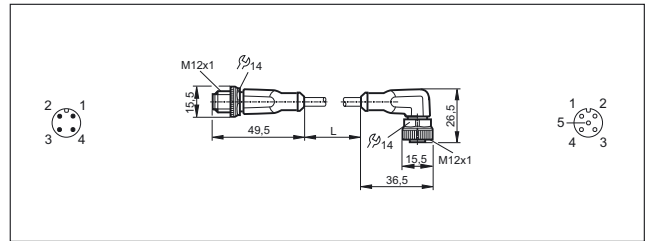

34

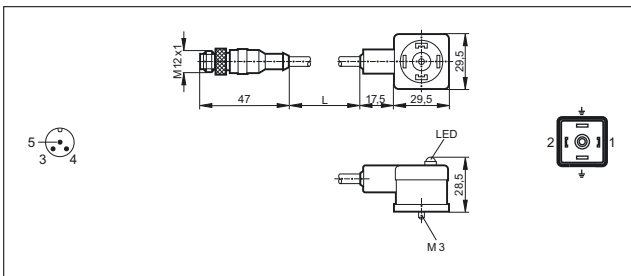

40

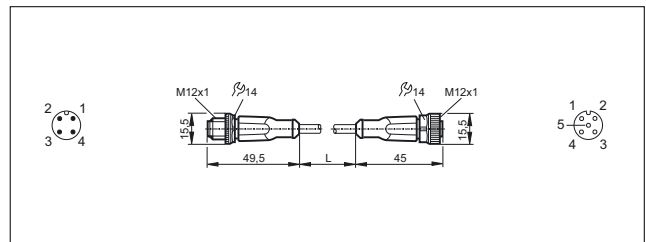

35

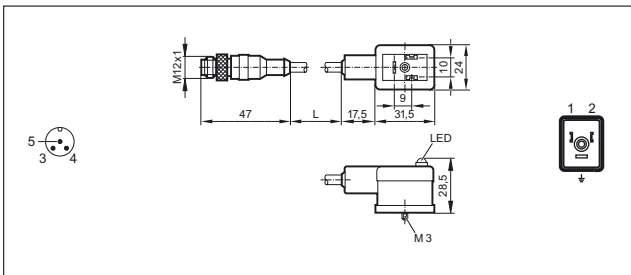

41

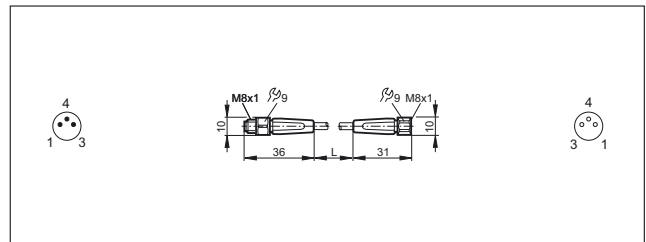

36

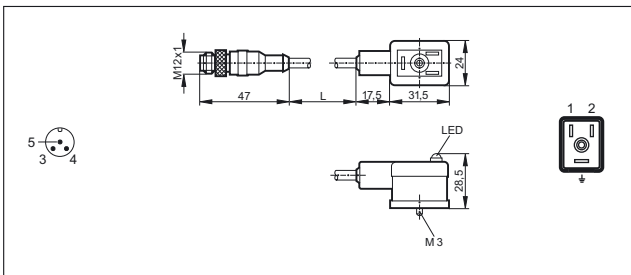

42

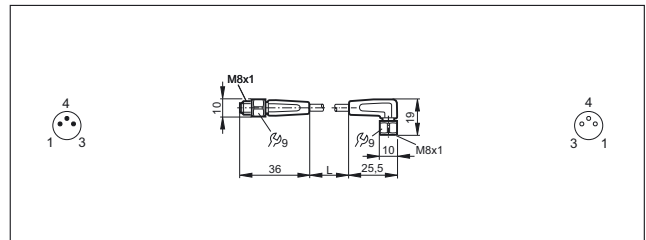

37

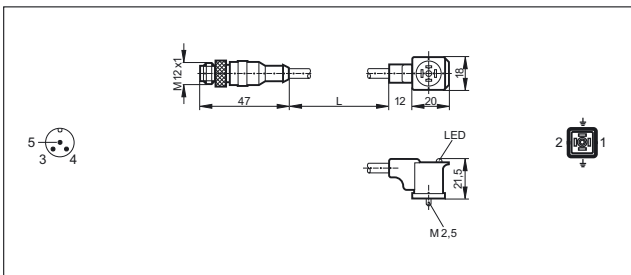

43

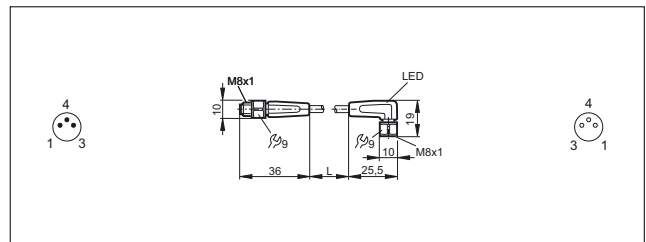

38

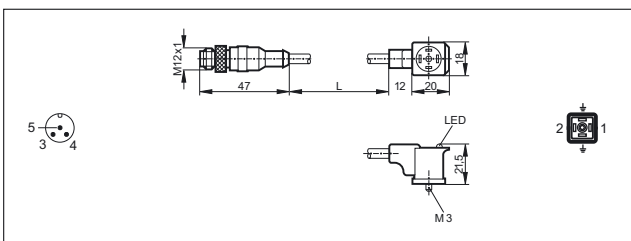

44

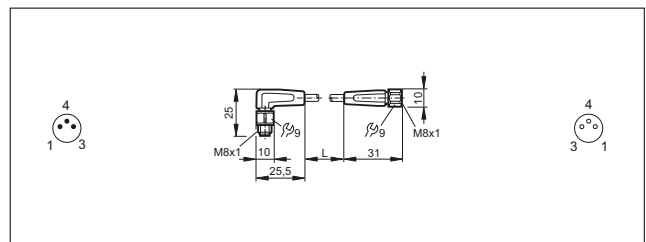

Scale drawings / drawing no. – CAD download: www.ifm.com

45

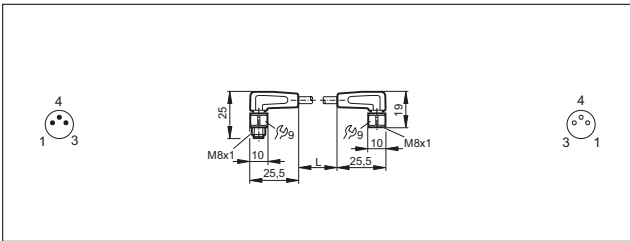

51

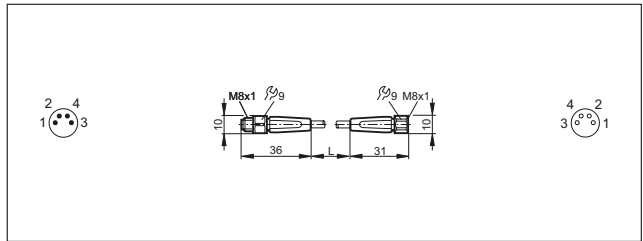

46

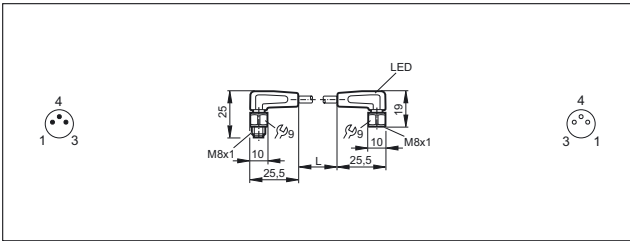

52

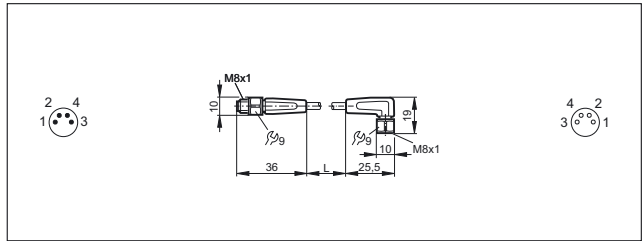

47

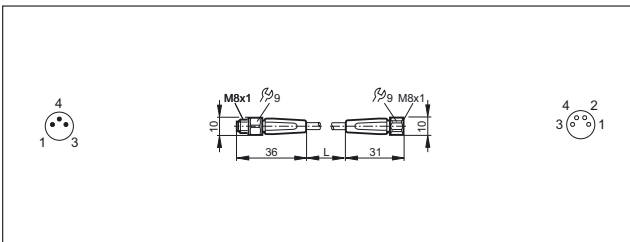

53

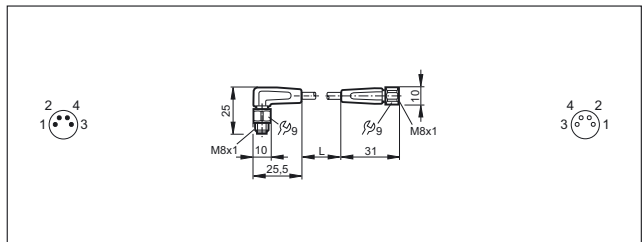

48

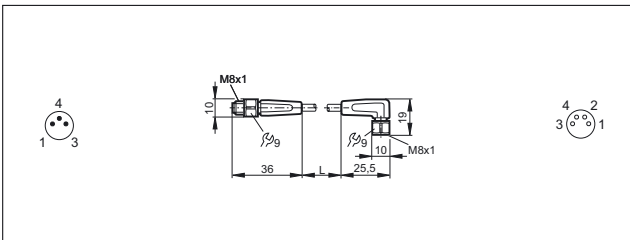

54

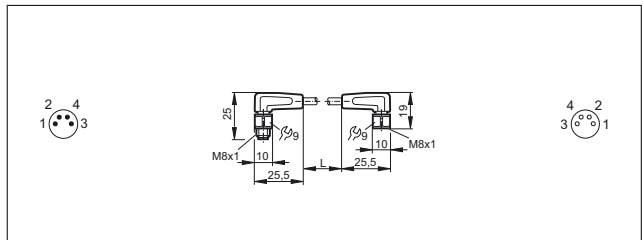

49

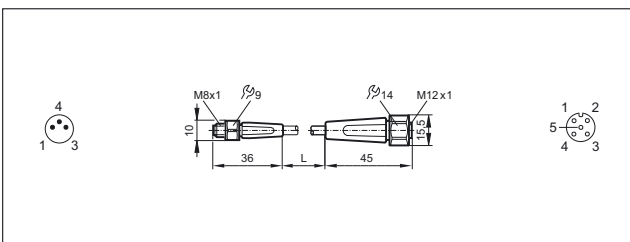

55

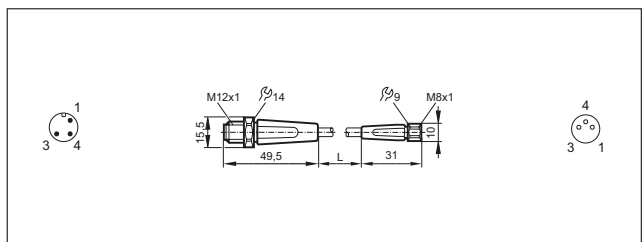

50

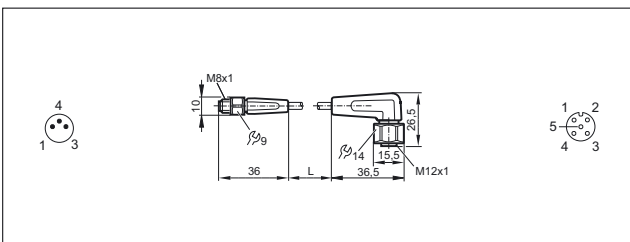

56

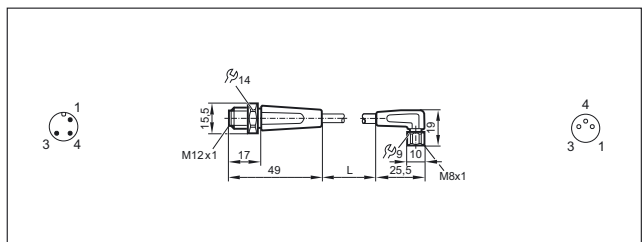

Scale drawings / drawing no. – CAD download: www.ifm.com

57

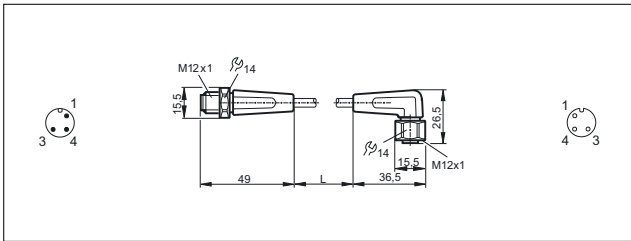

62

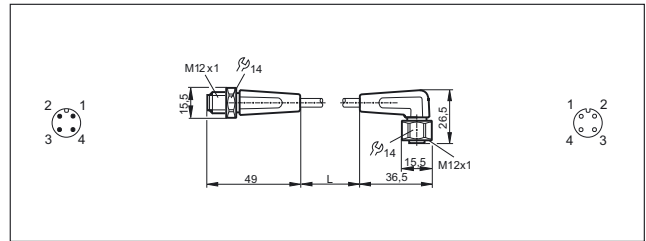

58

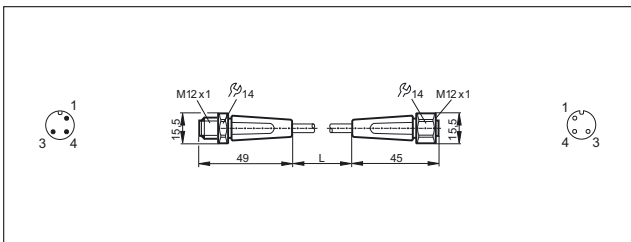

63

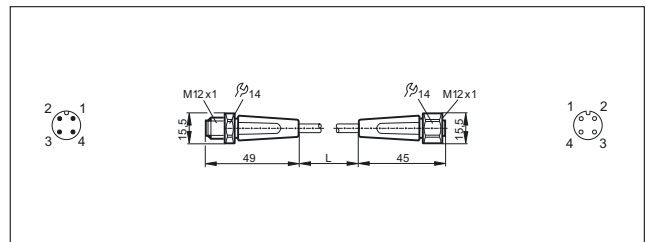

59

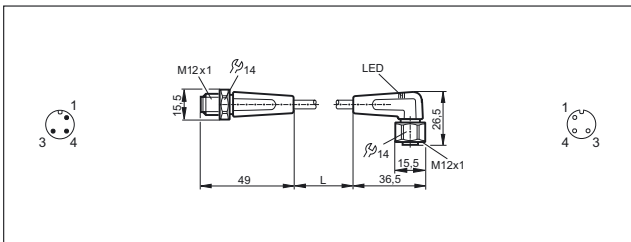

64

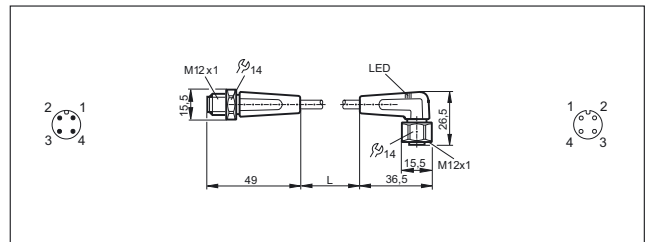

60

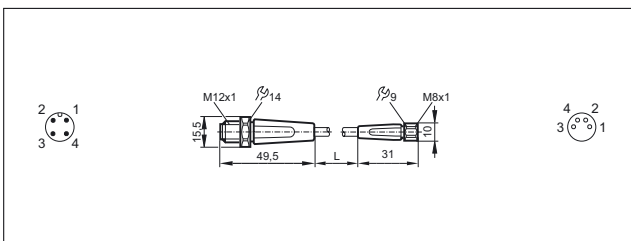

65

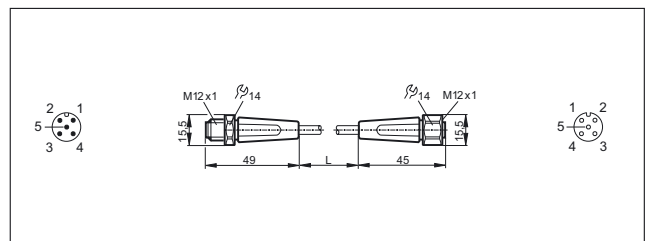

61

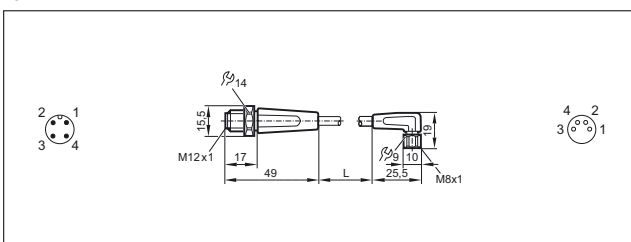

66

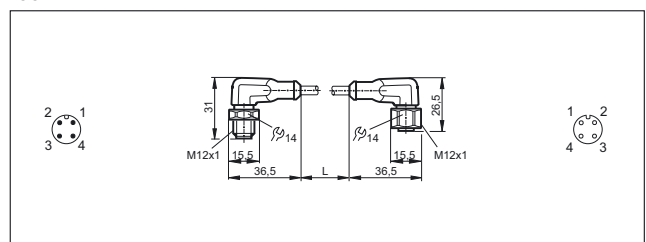









Splitter boxes

Splitter boxes enable the connection of several sensors and the transmission of the corresponding signals and supply voltages via a multi-wire cable. This considerably reduces installation and wiring complexity. In addition to splitter boxes with potted cable, versions with central connector are also available.

System overview	Page
Splitter boxes for industrial applications	806 - 812
Splitter boxes for hygienic and wet areas	812
Wiring diagrams	812 - 818
Scale drawings / drawing no. – CAD download: www.ifm.com	818 - 824

Splitter boxes for industrial applications











Type	Cable	Wire specification	Material housing / nut	U [V]	T _a [°C]	Protection	LEDs	Drawing no.	Order no.
Group 70 · M12 splitter box for 1 signal · Wiring diagram no. 1									
	5 m black PUR cable	4 x 0.25 mm ² , Ø 5 mm	TPU / Brass	10...55 DC	-25...80	IP 67	–	1	E10437
Group 71 · splitter box M8, 3-pole, LED · Wiring diagram no. 18									
	5 m black PUR cable	4 x 0.34 mm ² + 2 x 0.75 mm ² , Ø 6.4 mm	PBT-GF 20	10...30 DC	-25...80	IP 65 / IP 67 / IP 68	green / 4 x yellow	2	EBC048
	10 m black PUR cable	4 x 0.34 mm ² + 2 x 0.75 mm ² , Ø 6.4 mm	PBT-GF 20	10...30 DC	-25...80	IP 65 / IP 67 / IP 68	green / 4 x yellow	2	EBC049
Group 72 · splitter box M8, 3-pole, LED · Wiring diagram no. 19									
	M12 connector	–	PBT-GF 20	10...30 DC	-25...80	IP 67 / IP 68	green / 4 x yellow	3	EBC050
Group 73 · splitter box M8, 4-pole, LED · Wiring diagram no. 20									
	5 m black PUR cable	8 x 0.34 mm ² + 2 x 0.75 mm ² , Ø 7.4 mm	PBT-GF 20	10...30 DC	-25...80	IP 65 / IP 67 / IP 68	green / 8 x yellow	4	EBC051
	10 m black PUR cable	8 x 0.34 mm ² + 2 x 0.75 mm ² , Ø 7.4 mm	PBT-GF 20	10...30 DC	-25...80	IP 65 / IP 67 / IP 68	green / 8 x yellow	4	EBC052

Type	Cable	Wire specification	Material housing / nut	U [V]	T _a [°C]	Protection	LEDs	Drawing no.	Order no.
Group 74 · splitter box M8, 4-pole, LED · Wiring diagram no. 21									
	M16 connector	–	PBT-GF 20	10...30 DC	-25...80	IP 67 / IP 68	green / 8 x yellow	5	EBC053
Group 75 · splitter box M8, 3-pole, LED · Wiring diagram no. 22									
	5 m black PUR cable	8 x 0.34 mm ² + 2 x 0.75 mm ² , Ø 7.4 mm	PBT-GF 20	10...30 DC	-25...80	IP 65 / IP 67 / IP 68	green / 8 x yellow	6	EBC054
	10 m black PUR cable	8 x 0.34 mm ² + 2 x 0.75 mm ² , Ø 9.1 mm	PBT-GF 20	10...30 DC	-25...80	IP 65 / IP 67 / IP 68	green / 8 x yellow	6	EBC055
Group 76 · splitter box M8, 4-pole, LED · Wiring diagram no. 23									
	5 m black PUR cable	16 x 0.34 mm ² + 2 x 0.75 mm ² , Ø 8.5 mm	PBT-GF 20	10...30 DC	-25...80	IP 65 / IP 67 / IP 68	green / 16 x yellow	7	EBC056
	10 m black PUR cable	16 x 0.34 mm ² + 2 x 0.75 mm ² , Ø 8.5 mm	PBT-GF 20	10...30 DC	-25...80	IP 65 / IP 67 / IP 68	green / 16 x yellow	7	EBC057
Group 77 · splitter box M8, 3-pole, LED · Wiring diagram no. 24									
	5 m black PUR cable	4 x 0.34 mm ² + 2 x 0.75 mm ² , Ø 6.4 mm	PBT-GF 20	10...30 DC	-25...80	IP 65 / IP 67 / IP 68	green / 4 x yellow	2	EBC058
	10 m black PUR cable	4 x 0.34 mm ² + 2 x 0.75 mm ² , Ø 6.4 mm	PBT-GF 20	10...30 DC	-25...80	IP 65 / IP 67 / IP 68	green / 4 x yellow	2	EBC059
Group 78 · splitter box M8, 3-pole, LED · Wiring diagram no. 25									
	M12 connector	–	PBT-GF 20	10...30 DC	-25...80	IP 65 / IP 67 / IP 68	green / 4 x yellow	3	EBC060
Group 79 · splitter box M8, 4-pole, LED · Wiring diagram no. 26									
	5 m black PUR cable	8 x 0.34 mm ² + 2 x 0.75 mm ² , Ø 7.4 mm	PBT-GF 20	10...30 DC	-20...80	IP 65 / IP 67 / IP 68	green / 8 x yellow	4	EBC061
	10 m black PUR cable	8 x 0.34 mm ² + 2 x 0.75 mm ² , Ø 7.4 mm	PBT-GF 20	10...30 DC	-20...80	IP 65 / IP 67 / IP 68	green / 8 x yellow	4	EBC062
Group 80 · splitter box M8, 4-pole, LED · Wiring diagram no. 27									
	M16 connector	–	PBT-GF 20	10...30 DC	-25...80	IP 67 / IP 68	green / 8 x yellow	5	EBC063

Type	Cable	Wire specification	Material housing / nut	U [V]	T _a [°C]	Protection	LEDs	Drawing no.	Order no.
Group 81 · splitter box M8, 3-pole, LED · Wiring diagram no. 28									
	5 m black PUR cable	8 x 0.34 mm ² + 2 x 0.75 mm ² , Ø 9.1 mm	PBT-GF 20	10...30 DC	-25...80	IP 65 / IP 67 / IP 68	green / 8 x yellow	6	EBC064
	10 m black PUR cable	8 x 0.34 mm ² + 2 x 0.75 mm ² , Ø 9.1 mm	PBT-GF 20	10...30 DC	-25...80	IP 65 / IP 67 / IP 68	green / 8 x yellow	6	EBC065
Group 82 · splitter box M8, 4-pole, LED · Wiring diagram no. 29									
	5 m black PUR cable	16 x 0.34 mm ² + 2 x 0.75 mm ² , Ø 8.5 mm	PBT-GF 20	10...30 DC	-20...80	IP 65 / IP 67 / IP 68	green / 16 x yellow	7	EBC066
	10 m black PUR cable	16 x 0.34 mm ² + 2 x 0.75 mm ² , Ø 8.5 mm	PBT-GF 20	10...30 DC	-20...80	IP 65 / IP 67 / IP 68	green / 16 x yellow	7	EBC067
Group 83 · M12 splitter box for 1 signal · Wiring diagram no. 2									
	5 m black PUR cable	4 x 0.34 mm ² + 3 x 1 mm ² , Ø 7.5 mm	PA	30 AC/DC	-25...80	IP 67 / IP 68	–	8	EBC013
	10 m black PUR cable	4 x 0.34 mm ² + 3 x 1 mm ² , Ø 7.5 mm	PA	30 AC/DC	-25...80	IP 67 / IP 68	–	9	EBC025
Group 84 · M12 splitter box for 1 signal, LED · Wiring diagram no. 30									
	5 m black PUR cable	4 x 0.34 mm ² + 3 x 1 mm ² , Ø 7.5 mm	PA	10...30 DC	-25...80	IP 67 / IP 68	green / 4 x yellow	10	EBC015
	10 m black PUR cable	4 x 0.34 mm ² + 3 x 1 mm ² , Ø 7.5 mm	PA	10...30 DC	-25...80	IP 67 / IP 68	green / 4 x yellow	11	EBC027
Group 85 · M12 splitter box for 1 signal · Wiring diagram no. 3									
	5 m black PUR cable	6 x 0.34 mm ² + 3 x 1 mm ² , Ø 7.8 mm	PA	30 AC/DC	-25...80	IP 67 / IP 68	–	12	EBC017
	10 m black PUR cable	6 x 0.34 mm ² + 3 x 1 mm ² , Ø 7.8 mm	PA	30 AC/DC	-25...80	IP 67 / IP 68	–	13	EBC029
Group 86 · M12 splitter box for 1 signal, LED · Wiring diagram no. 31									
	5 m black PUR cable	6 x 0.34 mm ² + 3 x 1 mm ² , Ø 7.8 mm	PA	10...30 DC	-25...80	IP 67 / IP 68	green / 6 x yellow	14	EBC019
	10 m black PUR cable	6 x 0.34 mm ² + 3 x 1 mm ² , Ø 7.8 mm	PA	10...30 DC	-25...80	IP 67 / IP 68	green / 6 x yellow	15	EBC031

Type	Cable	Wire specification	Material housing / nut	U [V]	T _a [°C]	Protection	LEDs	Drawing no.	Order no.
Group 87 · M12 splitter box for 1 signal · Wiring diagram no. 4									
	5 m black PUR cable	8 x 0.34 mm ² + 3 x 0.75 mm ² , Ø 8.2 mm	PA	30 AC/DC	-25...80	IP 67 / IP 68	–	16	EBC021
	10 m black PUR cable	8 x 0.34 mm ² + 3 x 0.75 mm ² , Ø 8.2 mm	PA	30 AC/DC	-25...80	IP 67 / IP 68	–	17	EBC033
Group 88 · M12 splitter box for 1 signal, LED · Wiring diagram no. 32									
	5 m black PUR cable	8 x 0.34 mm ² + 3 x 0.75 mm ² , Ø 8.2 mm	PA	10...30 DC	-25...80	IP 67 / IP 68	green / 8 x yellow	18	EBC023
	10 m black PUR cable	8 x 0.34 mm ² + 3 x 0.75 mm ² , Ø 8.2 mm	PA	10...30 DC	-25...80	IP 67 / IP 68	green / 8 x yellow	19	EBC035
Group 89 · M12 splitter box for 1 signal · Wiring diagram no. 5									
	M23 connector	–	PA	30 AC/DC	-25...80	IP 67	–	20	EBC001
Group 90 · M12 splitter box for 1 signal, LED · Wiring diagram no. 33									
	M23 connector	–	PA	10...30 DC	-25...80	IP 67	green / 4 x yellow	21	EBC002
Group 91 · M12 splitter box for 1 signal · Wiring diagram no. 6									
	M23 connector	–	PA	30 AC/DC	-25...80	IP 67	–	22	EBC005
Group 92 · M12 splitter box for 1 signal, LED · Wiring diagram no. 34									
	M23 connector	–	PA	10...30 DC	-25...80	IP 67	green / 6 x yellow	23	EBC006
Group 93 · M12 splitter box for 1 signal · Wiring diagram no. 7									
	M23 connector	–	PA	30 AC/DC	-25...80	IP 67	–	24	EBC009
Group 94 · M12 splitter box for 1 signal, LED · Wiring diagram no. 35									
	M23 connector	–	PA	10...30 DC	-25...80	IP 67	green / 8 x yellow	25	EBC010

Type	Cable	Wire specification	Material housing / nut	U [V]	T _a [°C]	Protection	LEDs	Drawing no.	Order no.
Group 95 · M12 splitter box for 2 signals · Wiring diagram no. 8									
	5 m black PUR cable	8 x 0.34 mm ² + 3 x 1.0 mm ² , Ø 8.2 mm	PA	30 AC/DC	-25...80	IP 67 / IP 68	–	8	EBC014
	10 m black PUR cable	8 x 0.34 mm ² + 3 x 1.0 mm ² , Ø 8.2 mm	PA	30 AC/DC	-25...80	IP 67 / IP 68	–	9	EBC026
Group 96 · M12 splitter box for 2 signals, LED · Wiring diagram no. 36									
	5 m black PUR cable	8 x 0.34 mm ² + 3 x 1.0 mm ² , Ø 8.2 mm	PA	10...30 DC	-25...80	IP 67 / IP 68	green / 8 x yellow	26	EBC016
	10 m black PUR cable	8 x 0.34 mm ² + 3 x 1.0 mm ² , Ø 8.2 mm	PA	10...30 DC	-25...80	IP 67 / IP 68	green / 8 x yellow	27	EBC028
Group 97 · M12 splitter box for 2 signals · Wiring diagram no. 37									
	5 m black PUR cable	12 x 0.34 mm ² + 3 x 1.0 mm ² , Ø 8.8 mm	PA	30 AC/DC	-25...80	IP 67 / IP 68	–	12	EBC018
	10 m black PUR cable	12 x 0.34 mm ² + 3 x 1.0 mm ² , Ø 8.8 mm	PA	30 AC/DC	-25...80	IP 67 / IP 68	–	13	EBC030
Group 98 · M12 splitter box for 2 signals, LED · Wiring diagram no. 38									
	5 m black PUR cable	12 x 0.34 mm ² + 3 x 1.0 mm ² , Ø 8.8 mm	PA	10...30 DC	-25...80	IP 67 / IP 68	green / 12 x yellow	28	EBC020
	10 m black PUR cable	12 x 0.34 mm ² + 3 x 1.0 mm ² , Ø 8.8 mm	PA	10...30 DC	-25...80	IP 67 / IP 68	green / 12 x yellow	29	EBC032
Group 99 · M12 splitter box for 2 signals · Wiring diagram no. 39									
	5 m black PUR cable	16 x 0.34 mm ² + 3 x 0.75 mm ² , Ø 9.7 mm	PA	30 AC/DC	-25...80	IP 67 / IP 68	–	16	EBC022
	10 m black PUR cable	16 x 0.34 mm ² + 3 x 0.75 mm ² , Ø 9.7 mm	PA	30 AC/DC	-25...80	IP 67 / IP 68	–	17	EBC034
Group 100 · M12 splitter box for 2 signals, LED · Wiring diagram no. 40									
	5 m black PUR cable	16 x 0.34 mm ² + 3 x 1.0 mm ² , Ø 9.7 mm	PA	10...30 DC	-25...80	IP 67 / IP 68	green / 16 x yellow	30	EBC024
	10 m black PUR cable	16 x 0.34 mm ² + 3 x 1.0 mm ² , Ø 9.7 mm	PA	10...30 DC	-25...80	IP 67 / IP 68	green / 16 x yellow	31	EBC036

Type	Cable	Wire specification	Material housing / nut	U [V]	T _a [°C]	Protection	LEDs	Drawing no.	Order no.
Group 101 · M12 splitter box for 2 signals · Wiring diagram no. 9									
	M23 connector	–	PA	30 AC/DC	-25...80	IP 67	–	32	EBC003
Group 102 · M12 splitter box for 2 signals, LED · Wiring diagram no. 41									
	M23 connector	–	PA	10...30 DC	-25...80	IP 67	green / 8 x yellow	33	EBC004
Group 103 · M12 splitter box for 2 signals · Wiring diagram no. 10									
	M23 connector	–	PA	30 AC/DC	-25...80	IP 67	–	34	EBC007
Group 104 · M12 splitter box for 2 signals, LED · Wiring diagram no. 42									
	M23 connector	–	PA	10...30 DC	-25...80	IP 67	green / 12 x yellow	35	EBC008
Group 105 · M12 splitter box for 2 signals · Wiring diagram no. 11									
	M23 connector	–	PA	30 AC/DC	-25...80	IP 67	–	36	EBC011
Group 106 · M12 splitter box for 2 signals, LED · Wiring diagram no. 43									
	M23 connector	–	PA	10...30 DC	-25...80	IP 67	green / 16 x yellow	37	EBC012
Group 107 · Y splitter M12-plug / 2 x M12-socket, 5-pole · Wiring diagram no. 12									
		–	PA / Brass	250 AC 300 DC	-25...90	IP 65 / IP 67 / IP 68 / IP 69K	–	38	EBC113
Group 108 · Y splitter M12-plug / 2 x M12-socket, 5-pole · Wiring diagram no. 13									
		–	PA / Brass	60 AC 60 DC	-25...90	IP 65 / IP 67 / IP 68 / IP 69K	–	38	EBC114
Group 109 · Y splitter M12-plug / 2 x M12-socket, 5-pole · Wiring diagram no. 14									
		–	PA / Brass	60 AC 60 DC	-25...90	IP 65 / IP 67 / IP 68 / IP 69K	–	38	EBC115
Group 110 · Y splitter M12-plug / 2 x M12-socket, 5-pole · Wiring diagram no. 15									
		–	PA / Brass	60 AC 60 DC	-25...90	IP 65 / IP 67 / IP 68 / IP 69K	–	38	EBC116

You can find wiring diagrams and scale drawings from page 812

Type	Cable	Wire specification	Material housing / nut	U [V]	T _a [°C]	Protection	LEDs	Drawing no.	Order no.
------	-------	--------------------	------------------------	-------	---------------------	------------	------	-------------	-----------

Group 111 · Y splitter M12-plug / 2 x M12-socket, 5-pole · Wiring diagram no. 16

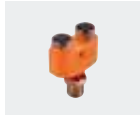

-	PA / Brass	60 AC 60 DC	-25...90	IP 65 / IP 67 / IP 68 / IP 69K	-	38	EBC117
---	------------	----------------	----------	-----------------------------------	---	----	---------------

Group 112 · Y splitter M12-plug / 2 x M12-socket, 5-pole · Wiring diagram no. 17

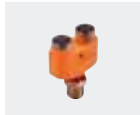

-	PA / Brass	60 AC 60 DC	-25...90	IP 65 / IP 67 / IP 68 / IP 69K	-	38	EBC118
---	------------	----------------	----------	-----------------------------------	---	----	---------------

Splitter boxes for hygienic and wet areas

Type	Cable	Wire specification	Material housing / nut	U [V]	T _a [°C]	Protection	LEDs	Drawing no.	Order no.
------	-------	--------------------	------------------------	-------	---------------------	------------	------	-------------	-----------

Group 113 · splitter box M12, LED · Wiring diagram no. 40



10 m black PUR / PVC cable	3 x 0.75 mm ² + 16 x 0.34 mm ² , Ø 11 mm	high-grade stainless steel	10...36 DC	-5...70	IP 69K	green / 16 x yellow	39	E11775
-------------------------------	---	-------------------------------	------------	---------	--------	------------------------	----	---------------

Wiring diagrams

Core colours

BK	black
BN	brown
BU	blue
WH	white
GN	green
GY	grey
YE	yellow
PK	pink
RD	red
VT	lilac
GN/YE	green/yellow

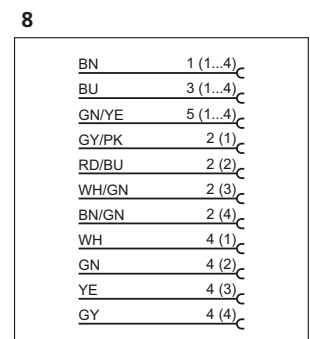
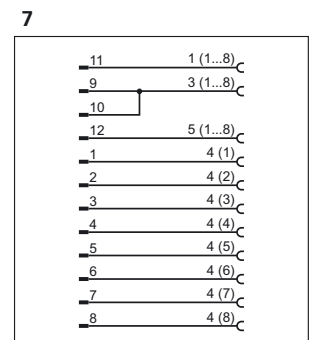
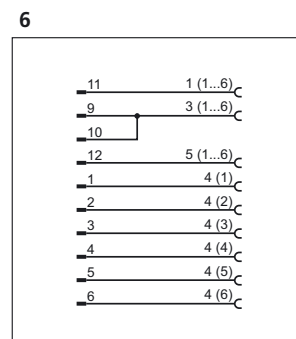
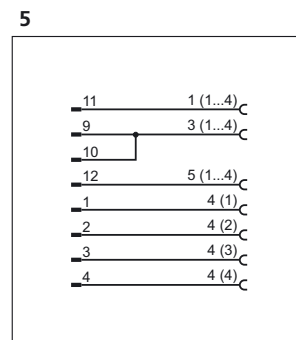
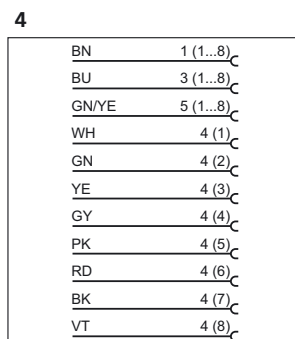
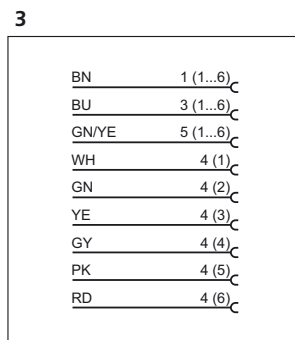
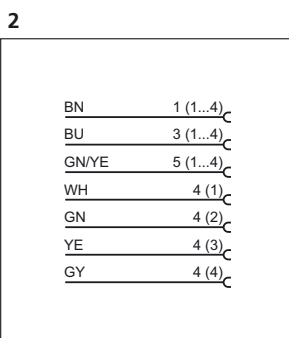
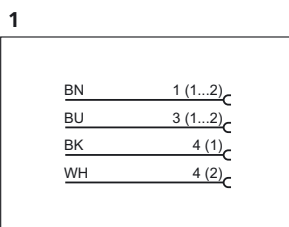

Wiring diagrams

9

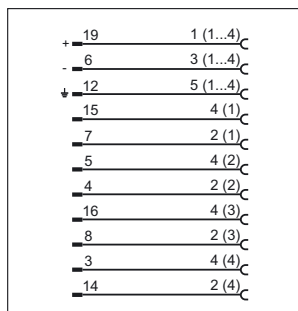

11

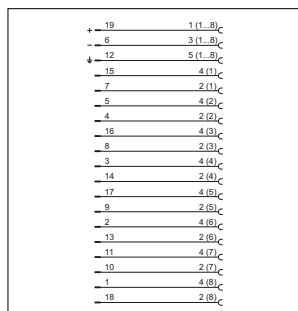

13

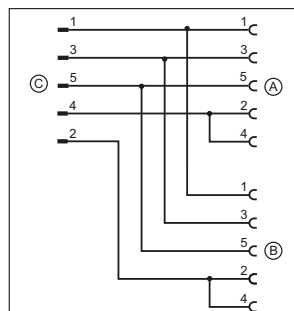

15

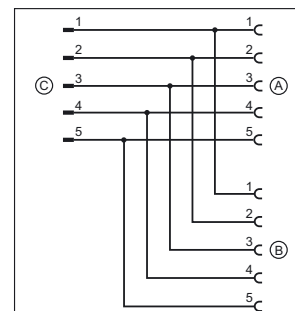

10

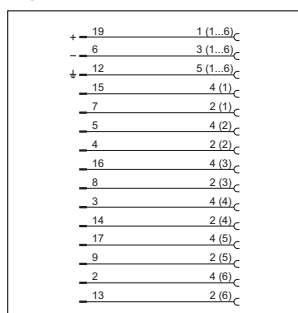

12

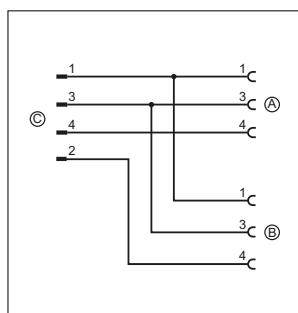

14

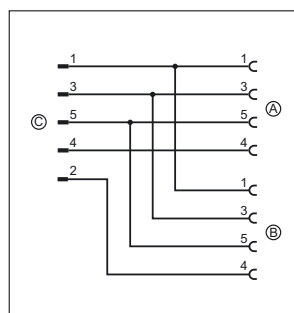

16

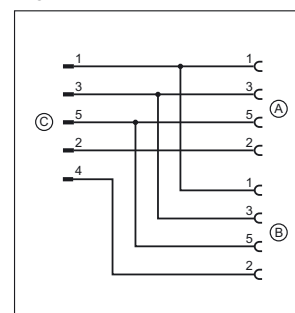

17

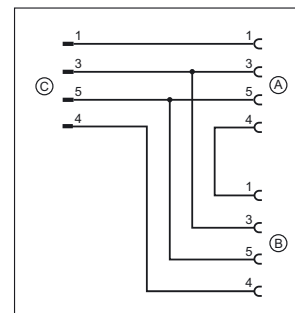

18

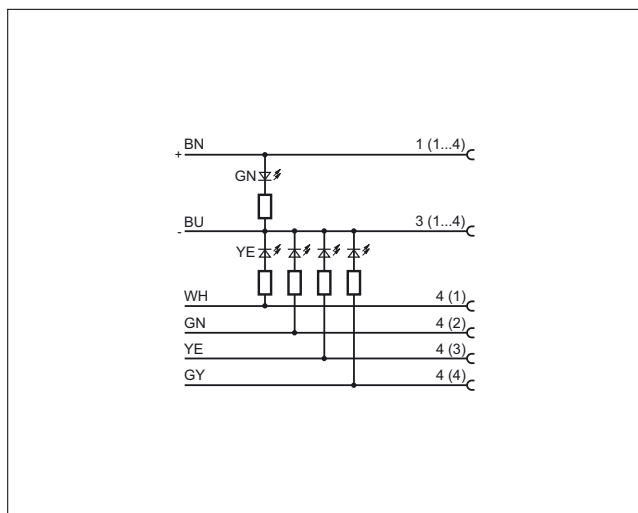

19

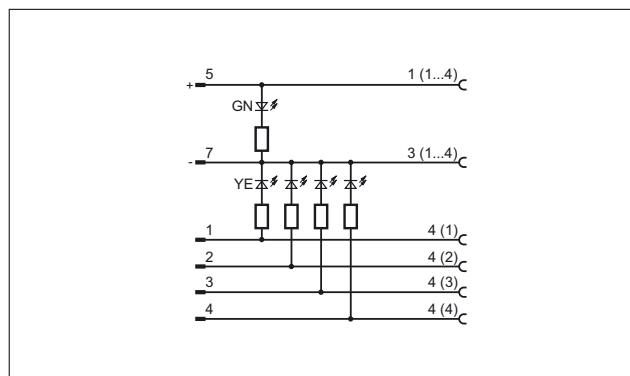

Wiring diagrams

20

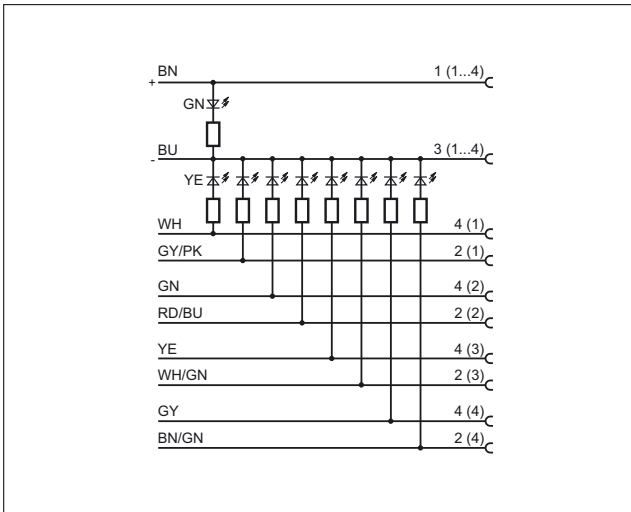

21

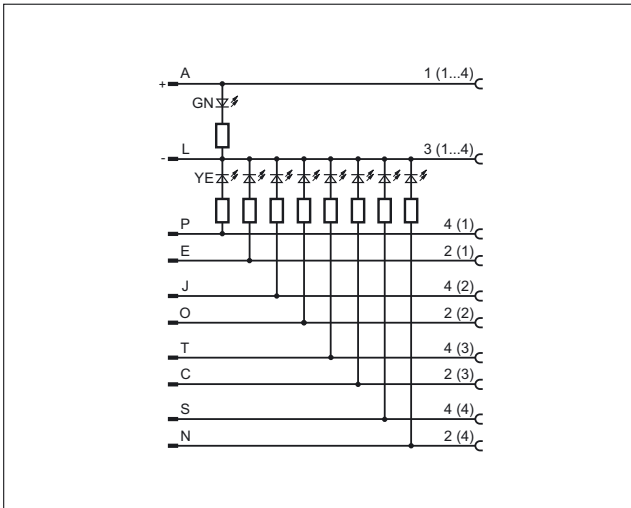

22

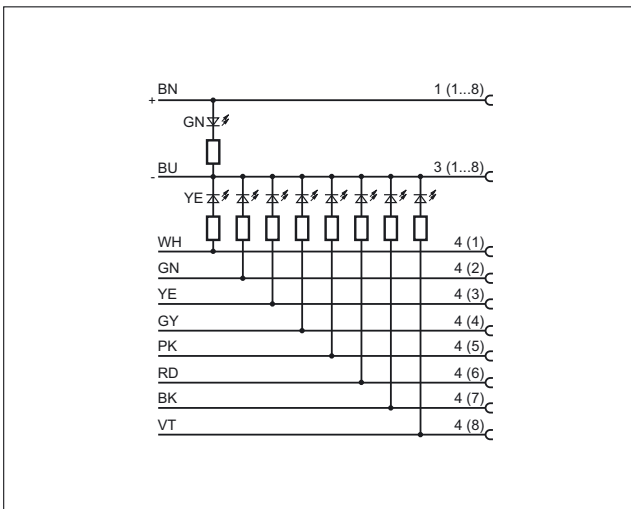

23

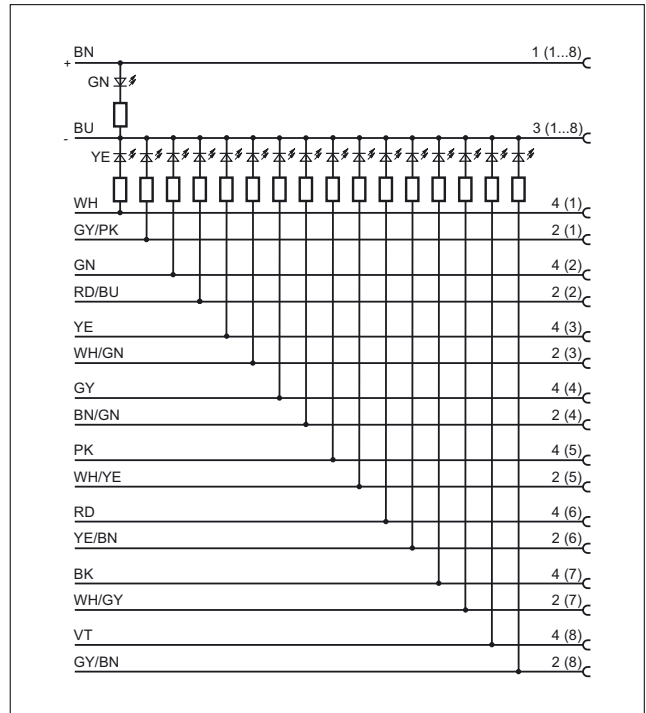

24

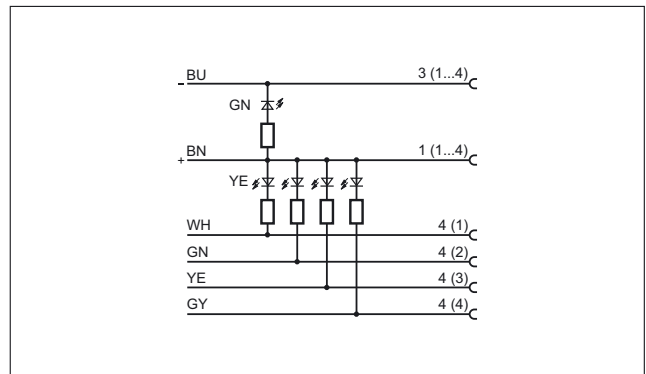

25

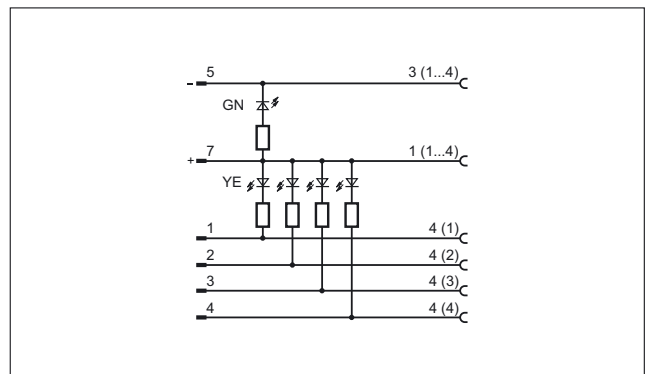

Wiring diagrams

26

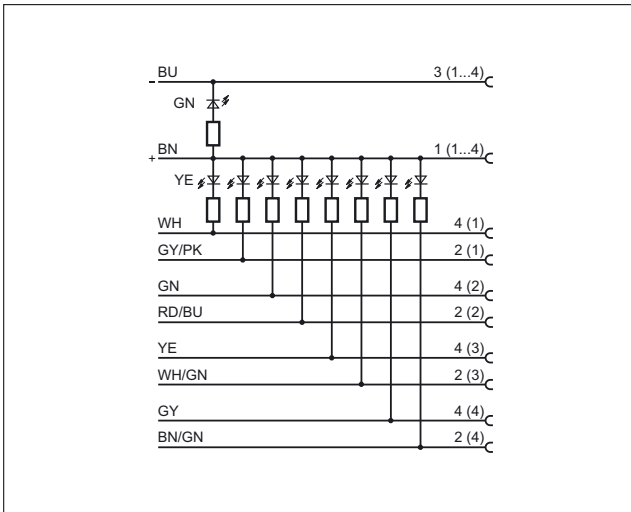

29

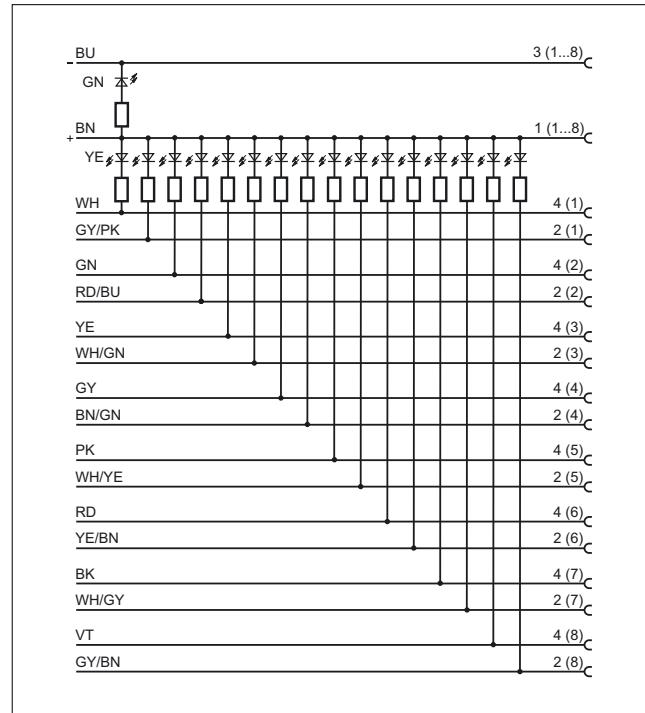

27

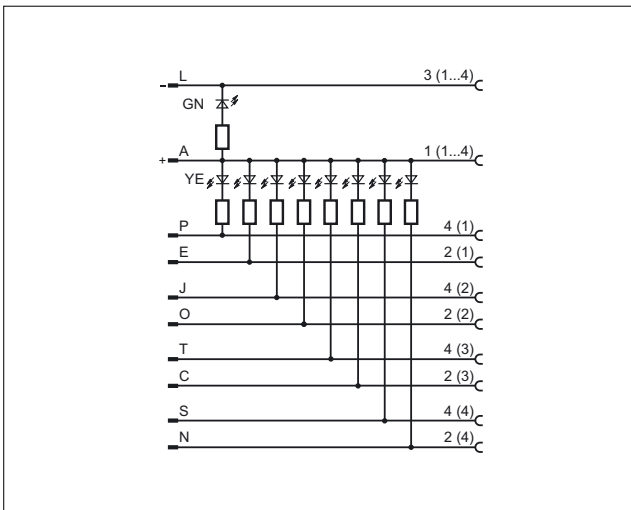

30

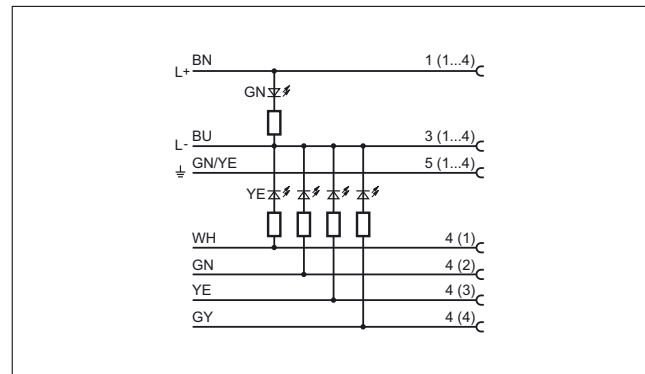

28

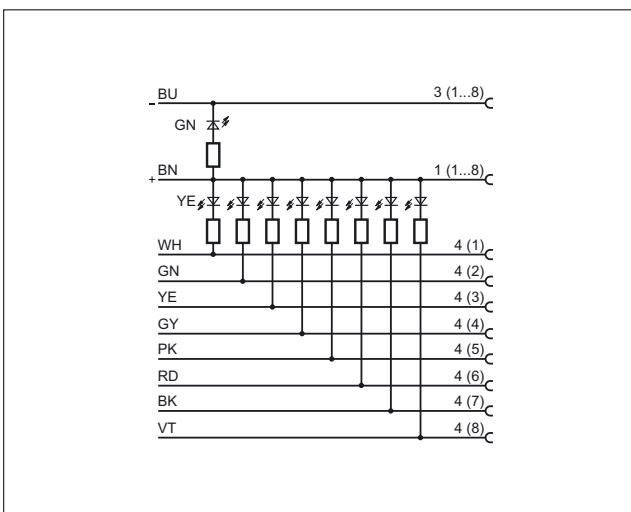

31

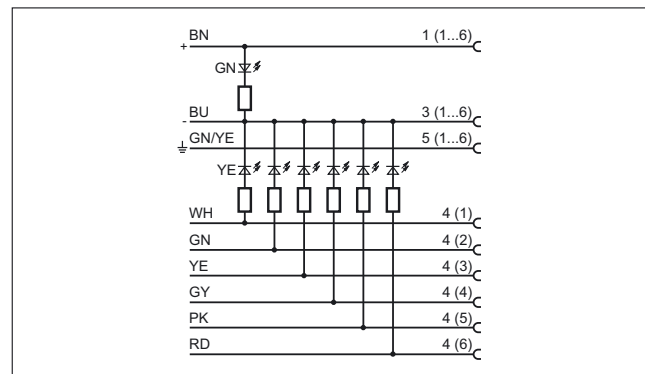

Wiring diagrams

32

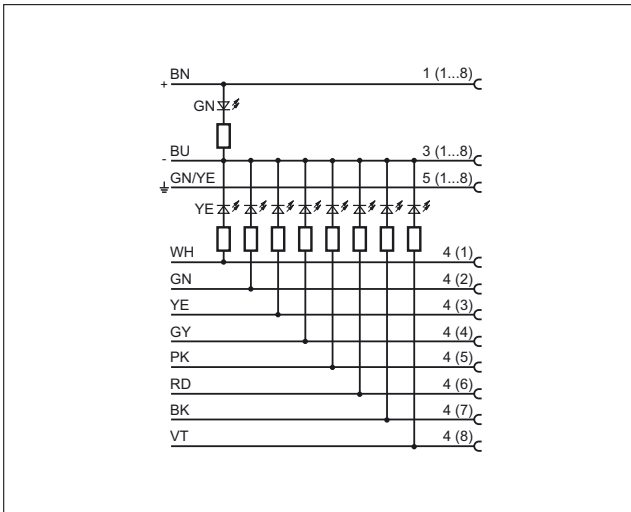

35

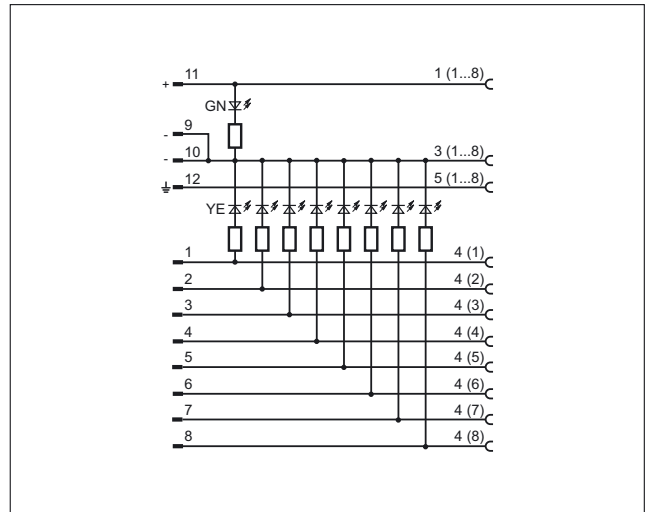

33

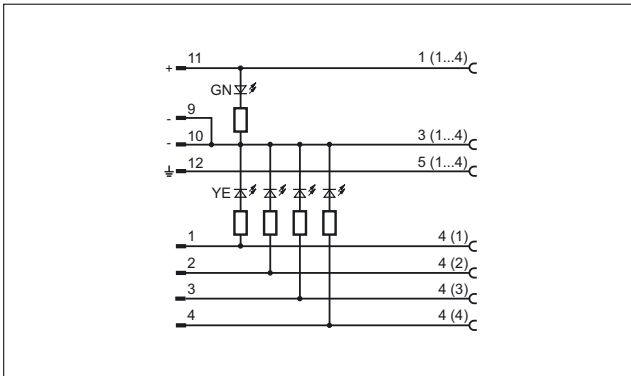

36

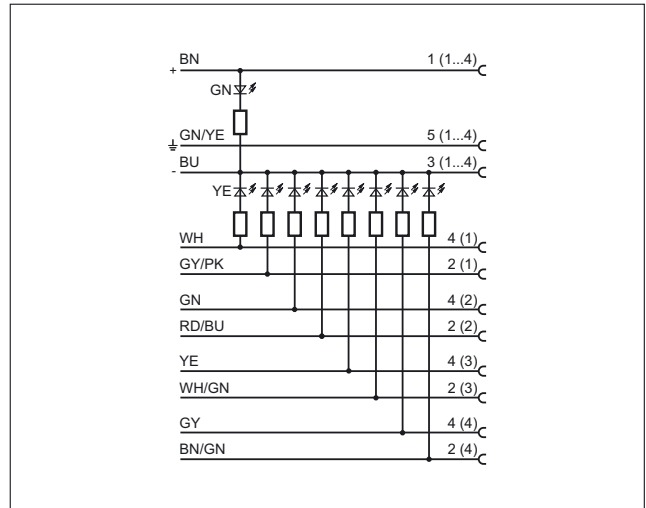

34

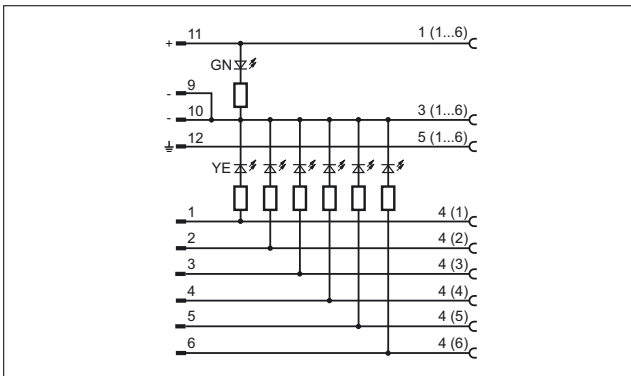

37

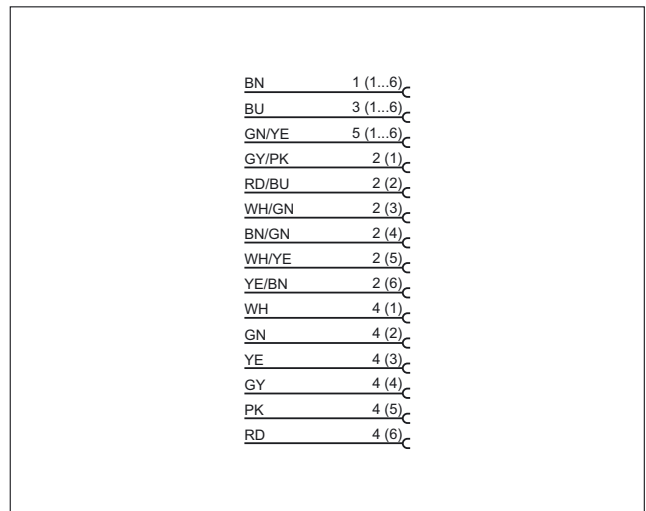

BN	1 (1...6)
BU	3 (1...6)
GN/YE	5 (1...6)
GY/PK	2 (1)
RD/BU	2 (2)
WH/GN	2 (3)
BN/GN	2 (4)
WH/YE	2 (5)
YE/BN	2 (6)
WH	4 (1)
GN	4 (2)
YE	4 (3)
GY	4 (4)
PK	4 (5)
RD	4 (6)

Wiring diagrams

38

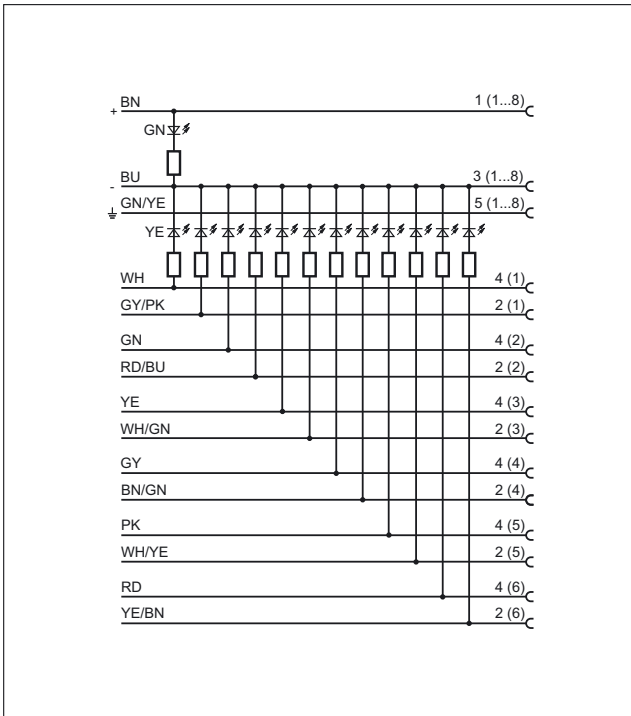

40

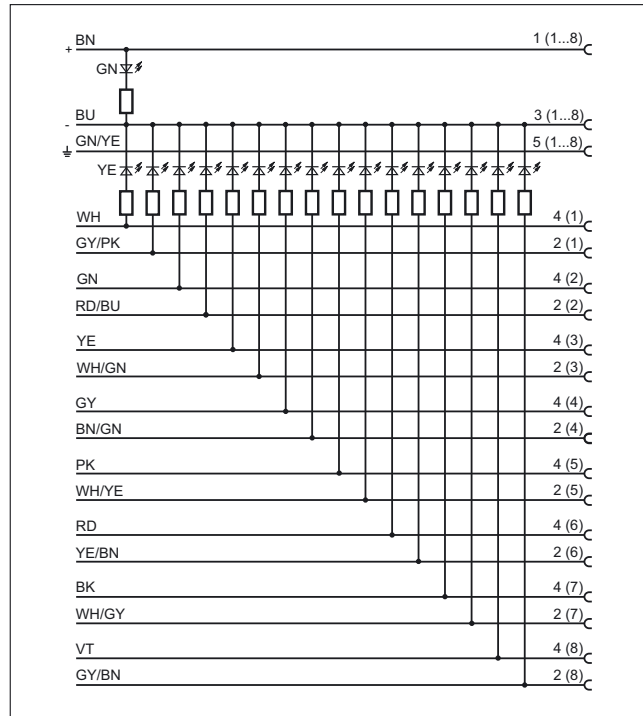

39

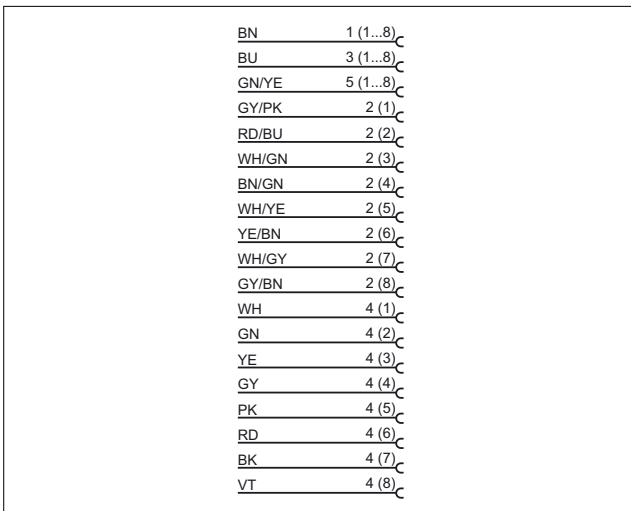

41

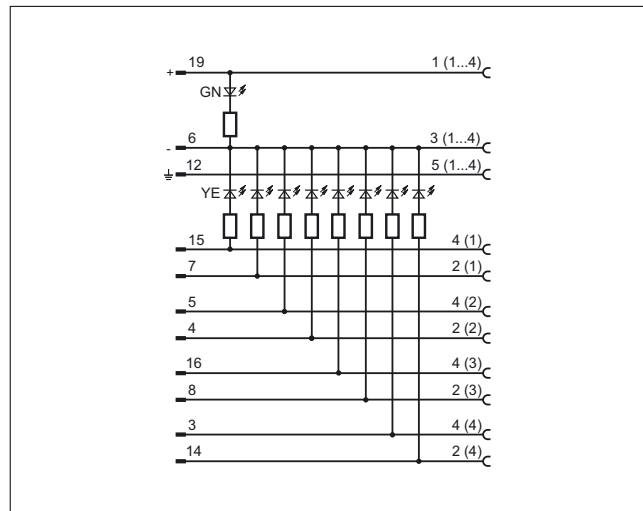

Wiring diagrams

42

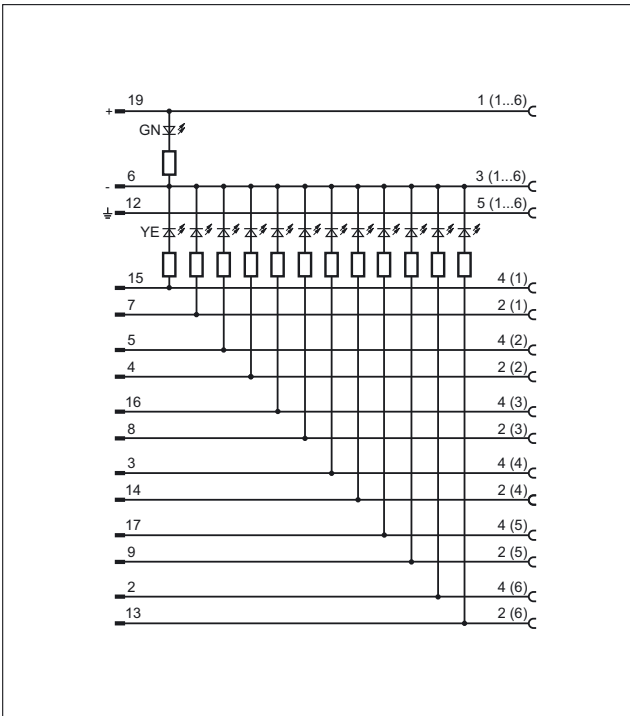

43

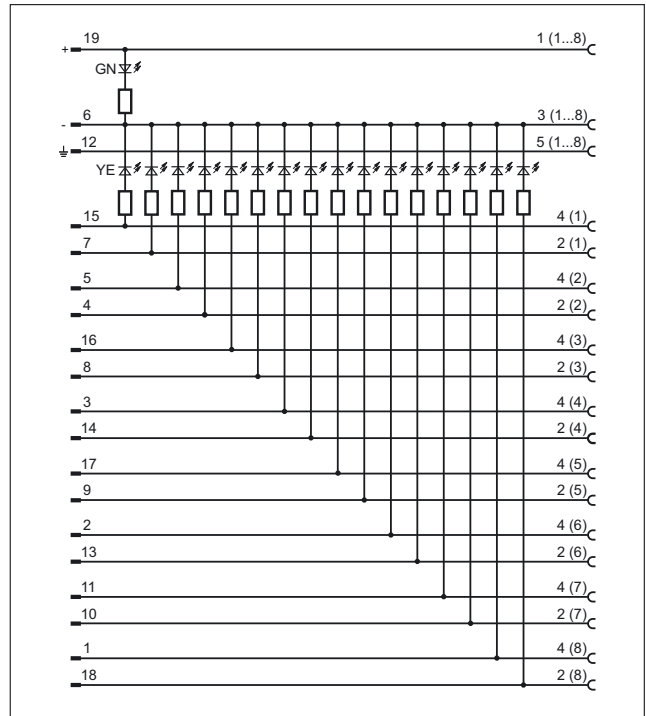

Scale drawings / drawing no. – CAD download: www.ifm.com

1

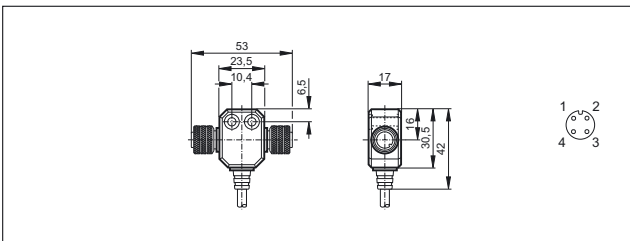

4

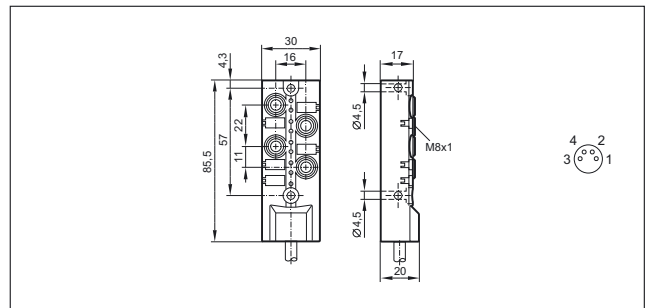

2

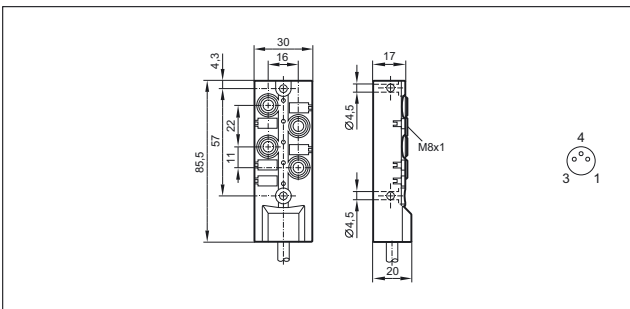

5

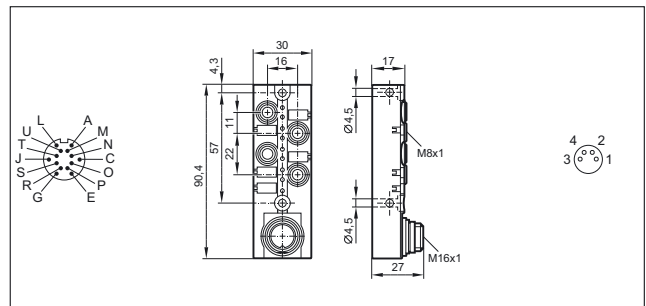

3

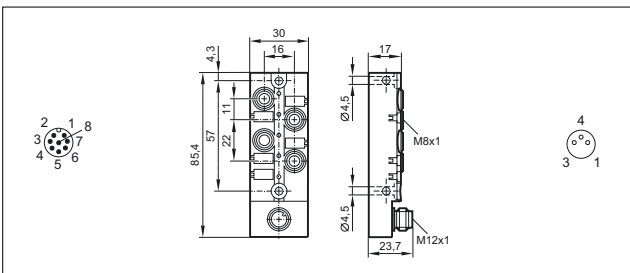

Scale drawings / drawing no. – CAD download: www.ifm.com

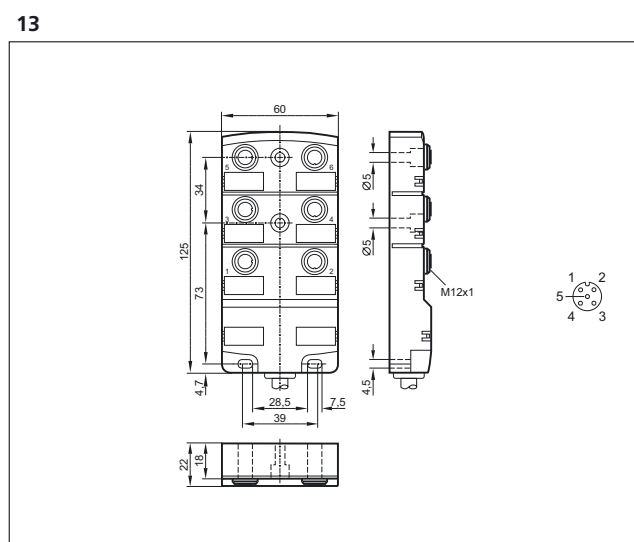
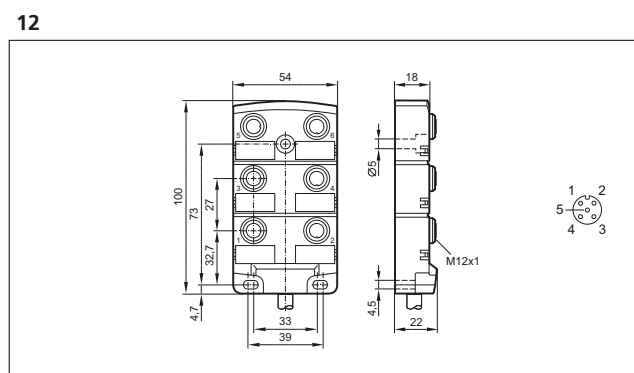
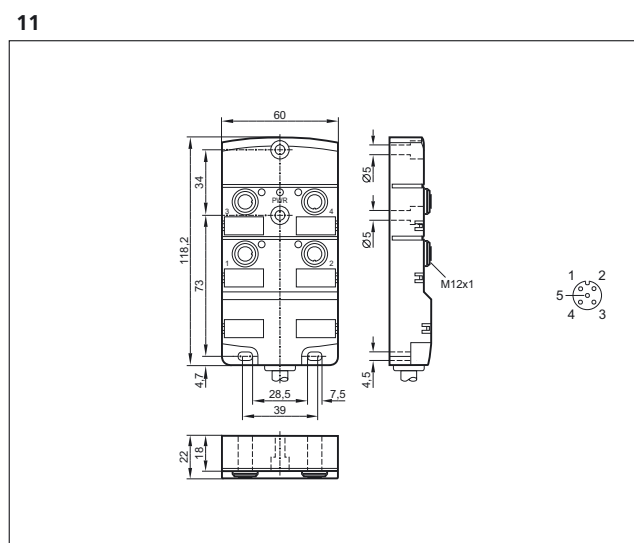
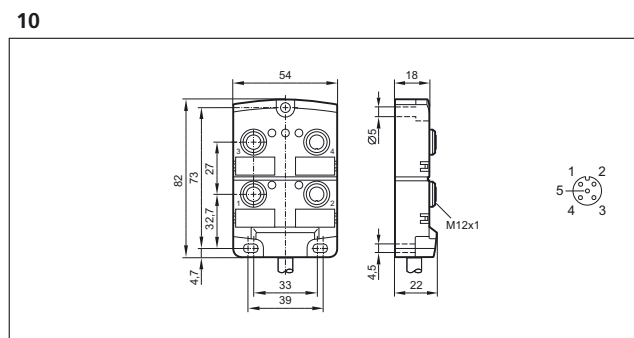
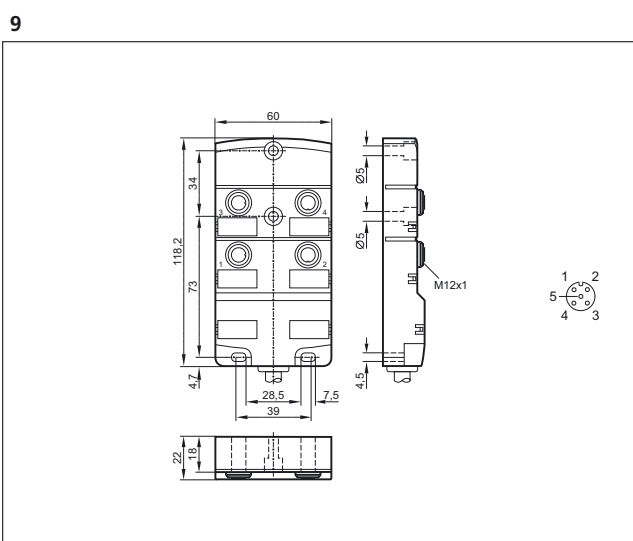
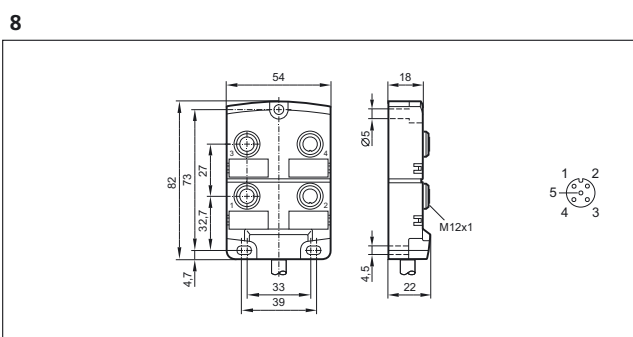
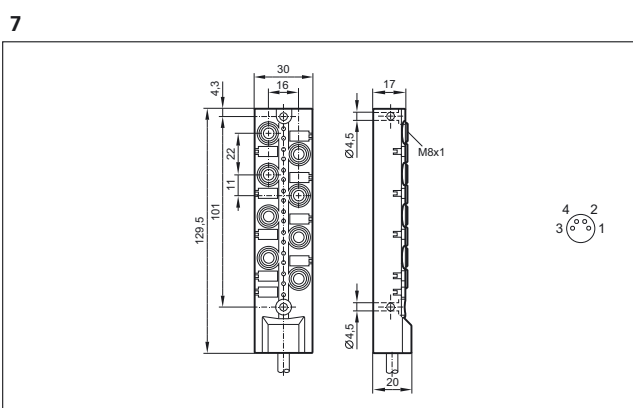
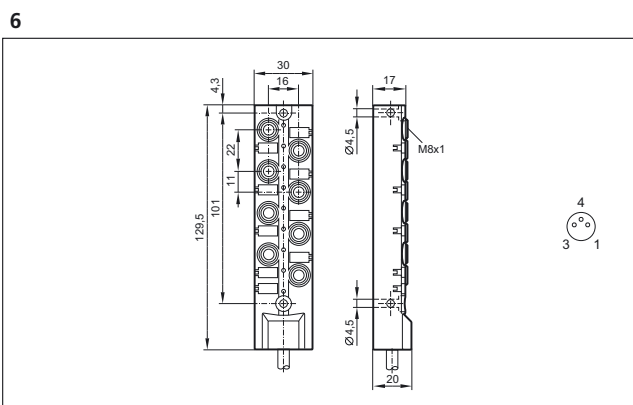

Scale drawings / drawing no. – CAD download: www.ifm.com

14

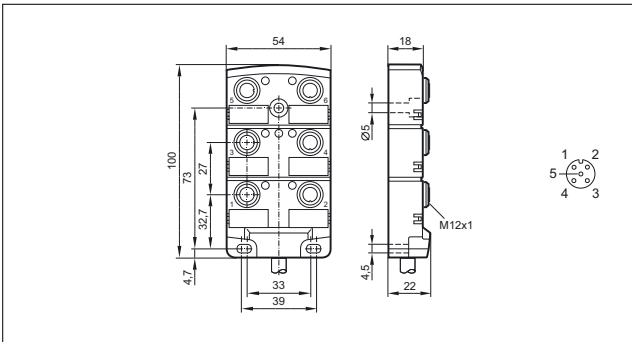

17

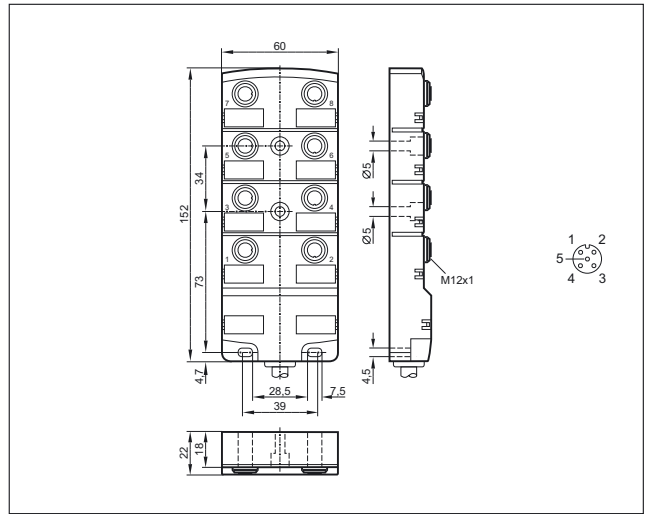

15

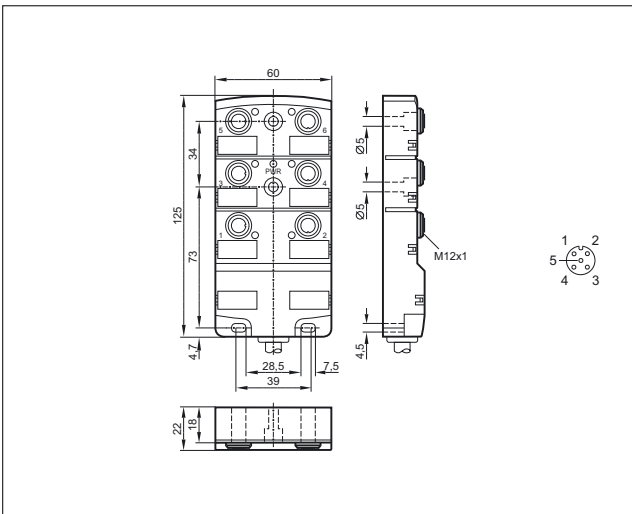

18

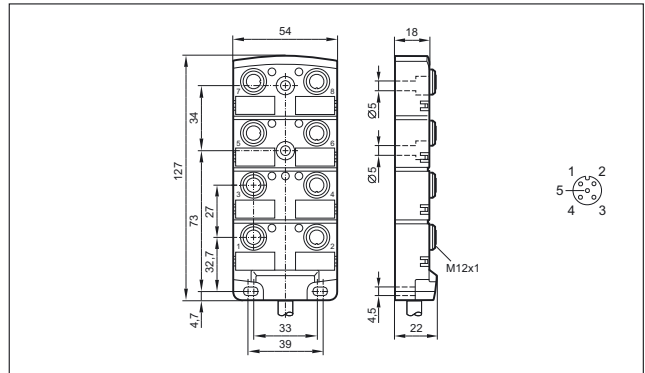

16

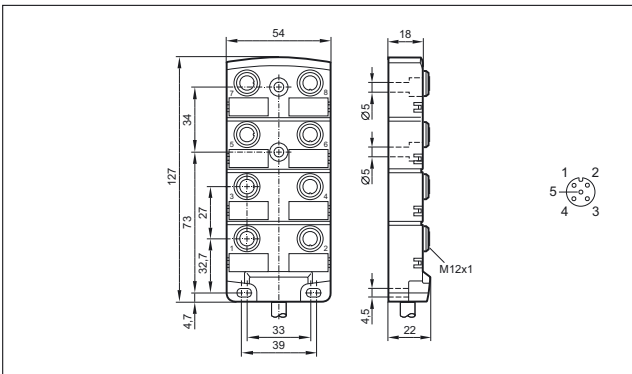

19

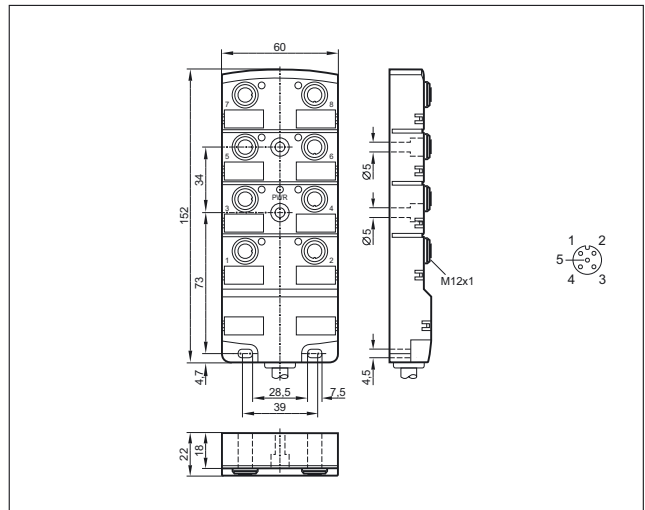

Scale drawings / drawing no. – CAD download: www.ifm.com

20

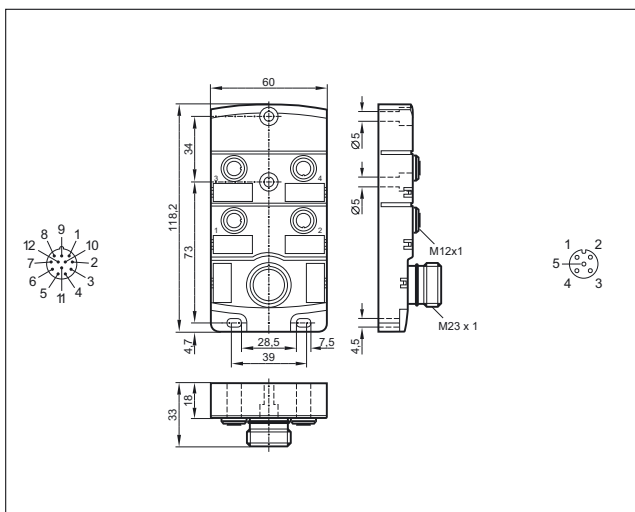

23

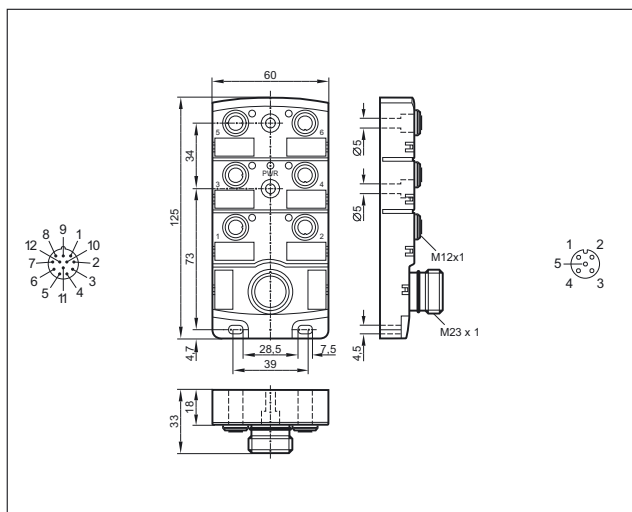

21

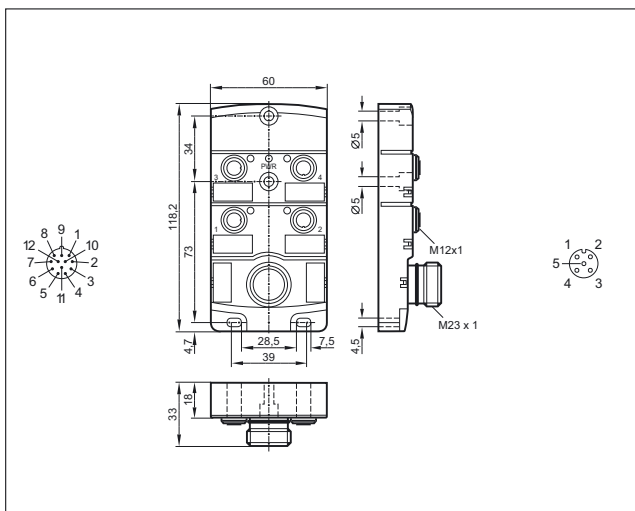

24

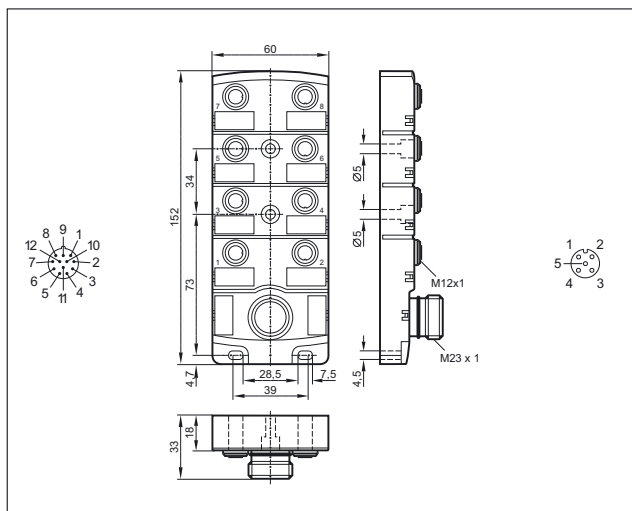

22

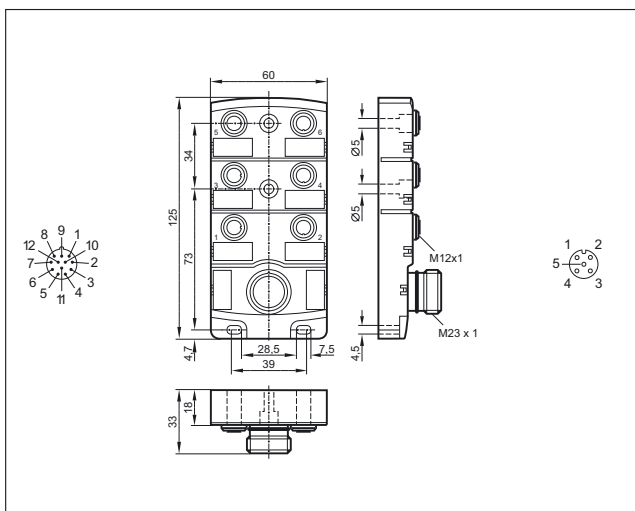

25

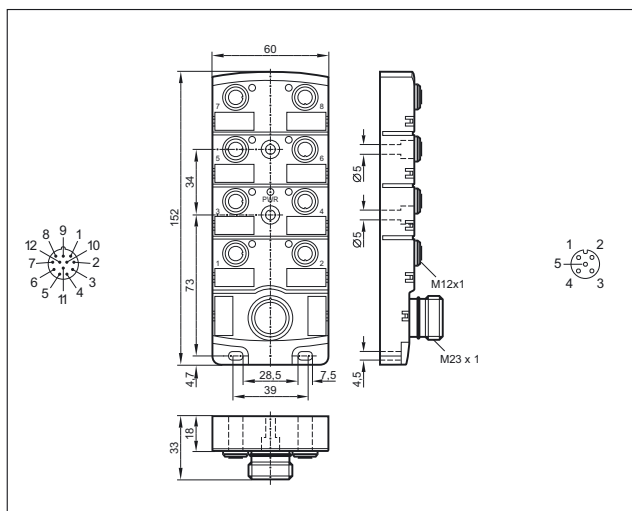

Scale drawings / drawing no. – CAD download: www.ifm.com

26

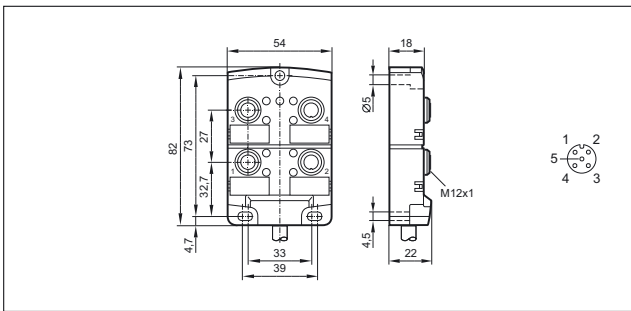

30

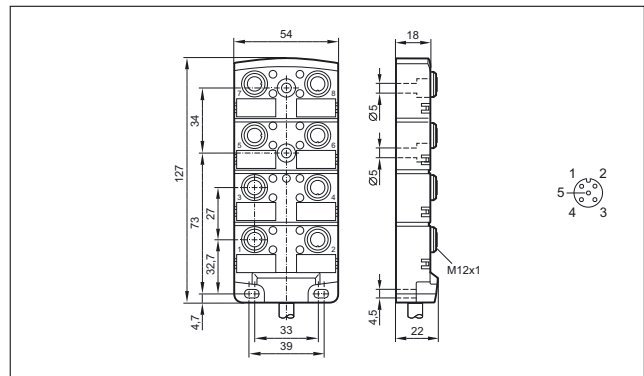

27

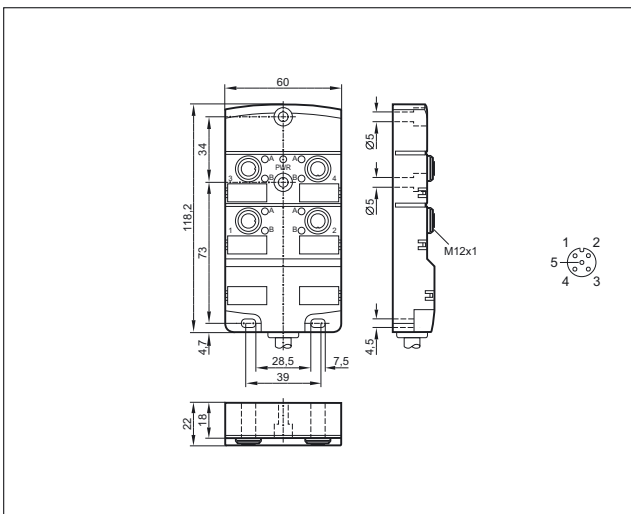

31

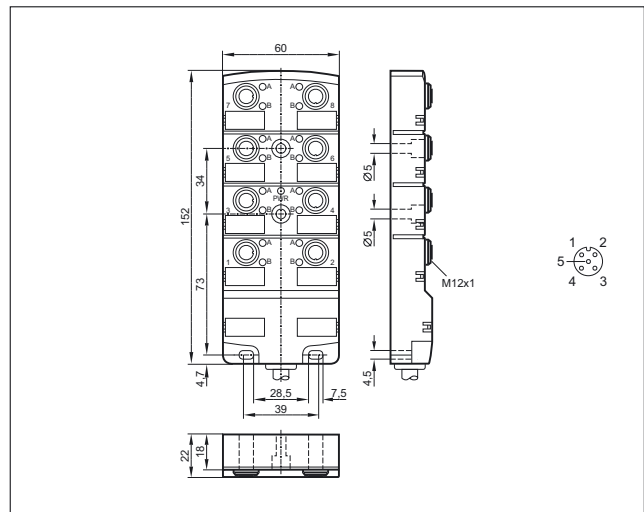

28

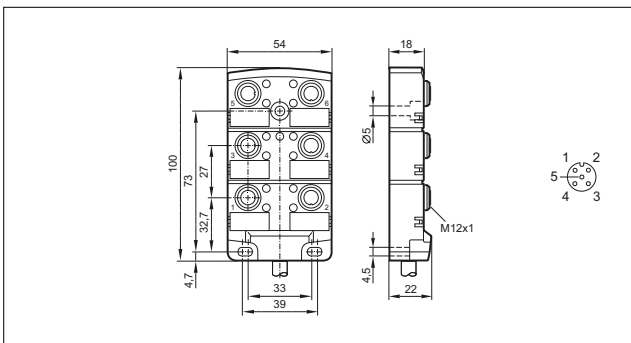

32

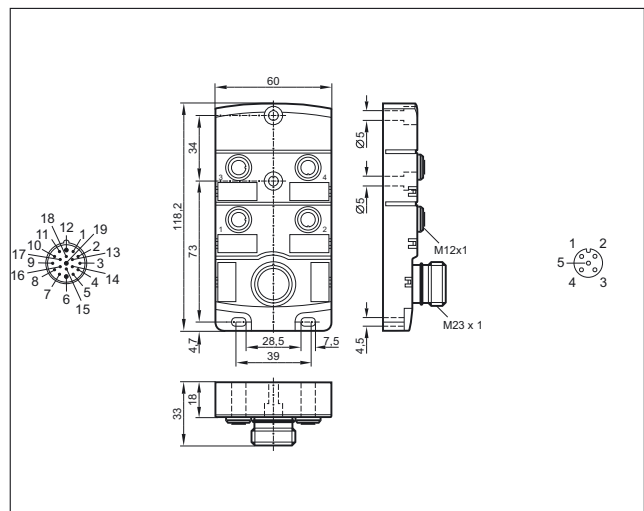

29

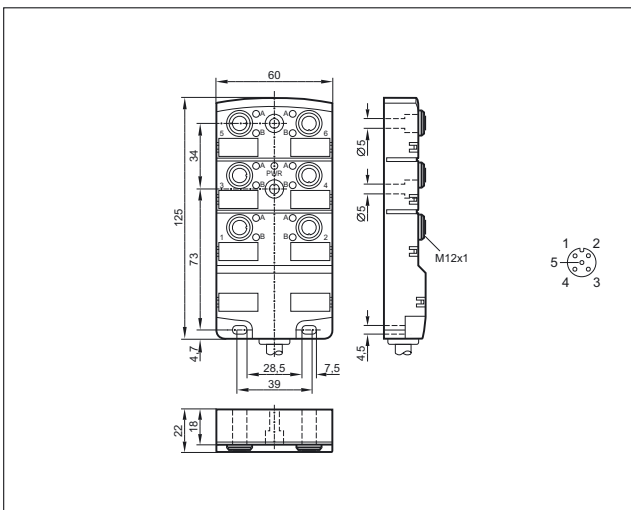

Scale drawings / drawing no. – CAD download: www.ifm.com

33

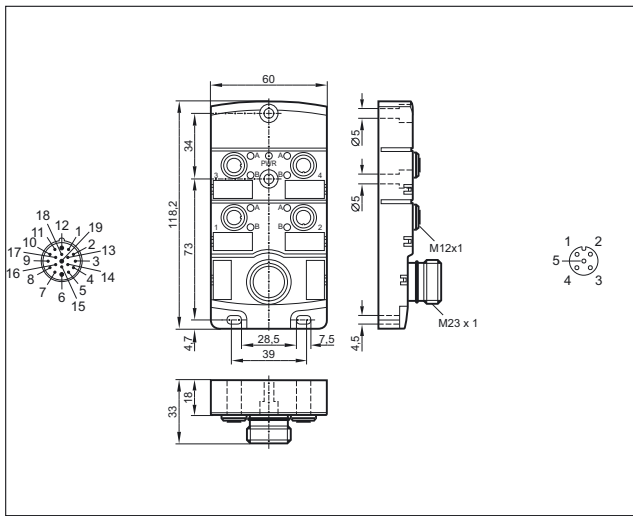

36

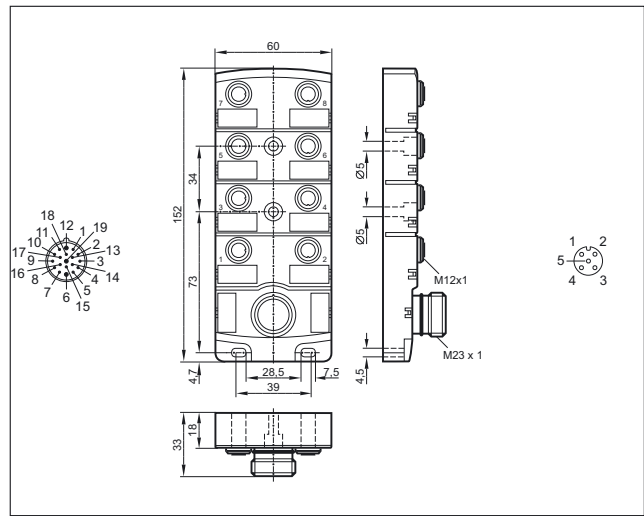

34

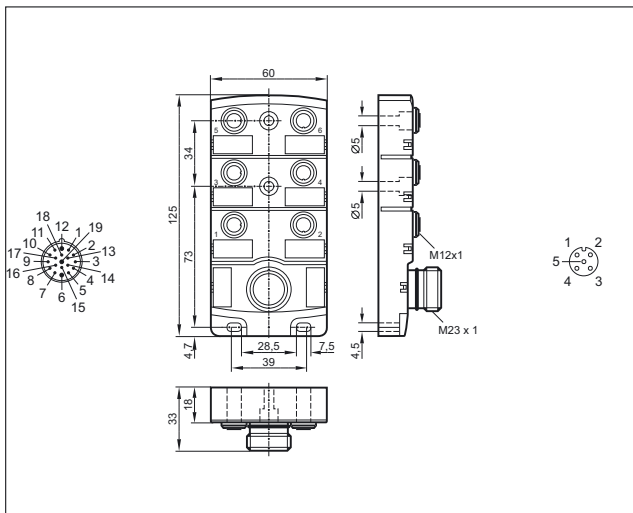

37

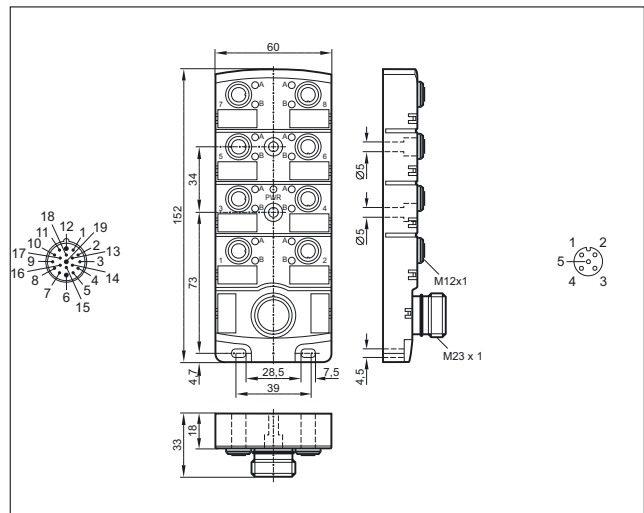

35

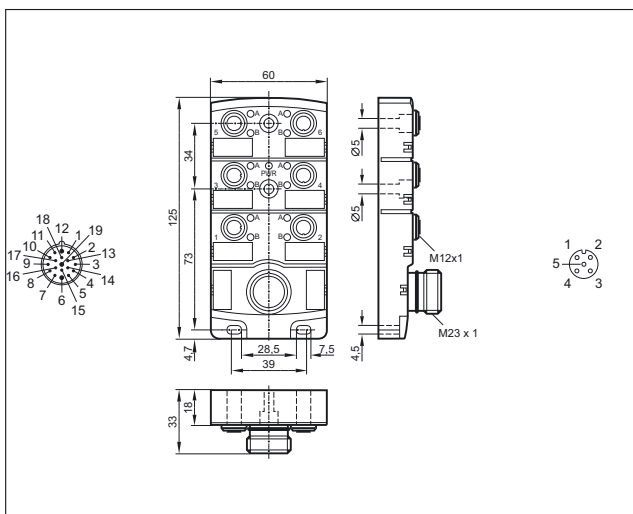

38

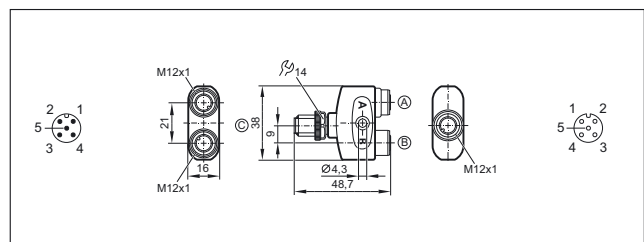

Scale drawings / drawing no. – CAD download: www.ifm.com

39

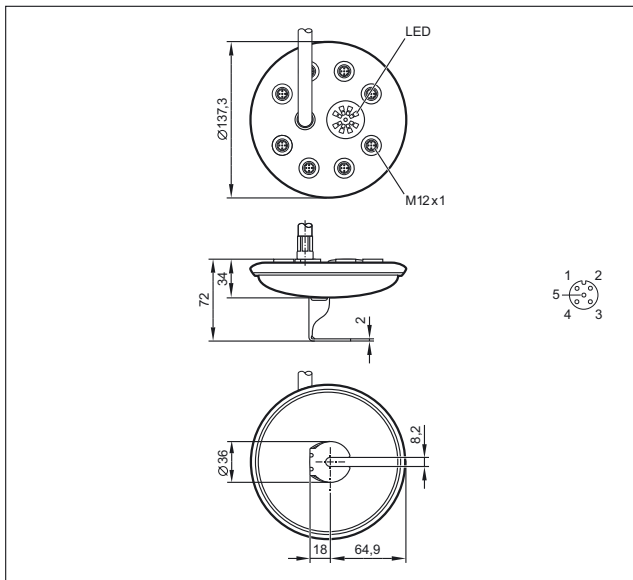





Y-splitters

Y connection cables are used for the distribution of signals and the connection of two units to a connector.



System overview	Page
M12 – M12 jumpers for industrial applications	826 - 827
Jumpers for hygienic and wet areas	827
Wiring diagrams	828
Scale drawings / drawing no. – CAD download: www.ifm.com	828

M12 – M12 jumpers for industrial applications

Type	Cable	Wire specification	Material housing / nut	U [V]	T _a [°C]	Pro-tection	LEDs	Drawing no.	Order no.
Group 56 · Y connection cable , plug: M12, 5-pole, socket: M12, 5-pole, 5-wire · Wiring diagram no. 1									
	1 m black PUR cable	4 x 0.34 mm ² , Ø 4.9 mm	TPU / Brass	60 AC 60 DC	-25...90	IP 65 / IP 67 / IP 68 / IP 69K	–	1	EVC431
	2 m black PUR cable	4 x 0.34 mm ² , Ø 4.9 mm	TPU / Brass	60 AC 60 DC	-25...90	IP 65 / IP 67 / IP 68 / IP 69K	–	1	EVC432
	5 m black PUR cable	4 x 0.34 mm ² , Ø 4.9 mm	TPU / Brass	60 AC 60 DC	-25...90	IP 65 / IP 67 / IP 68 / IP 69K	–	1	EVC433
	1 m black PUR cable	4 x 0.34 mm ² , Ø 4.9 mm	TPU / Brass	60 AC 60 DC	-25...90	IP 65 / IP 67 / IP 68 / IP 69K	–	2	EVC434
	2 m black PUR cable	4 x 0.34 mm ² , Ø 4.9 mm	TPU / Brass	60 AC 60 DC	-25...90	IP 65 / IP 67 / IP 68 / IP 69K	–	2	EVC435
	5 m black PUR cable	4 x 0.34 mm ² , Ø 4.9 mm	TPU / Brass	60 AC 60 DC	-25...90	IP 65 / IP 67 / IP 68 / IP 69K	–	2	EVC436
Group 58 · Y connection cable , plug: M12, 4-pole, socket: M12, 5-pole, 5-wire, LED · Wiring diagram no. 2									
	1 m black PUR cable	3 x 0.34 mm ² , Ø 4.9 mm	TPU / Brass	10...36 DC	-25...90	IP 65 / IP 67 / IP 68 / IP 69K	green / yellow	3	EVC437

Type	Cable	Wire specification	Material housing / nut	U [V]	T _a [°C]	Protection	LEDs	Drawing no.	Order no.
Group 58 · Y connection cable , plug: M12, 4-pole, socket: M12, 5-pole, 5-wire, LED · Wiring diagram no. 2									
	2 m black PUR cable	3 x 0.34 mm ² , Ø 4.9 mm	TPU / Brass	10...36 DC	-25...90	IP 65 / IP 67 / IP 68 / IP 69K	green / yellow	3	EVC438
	5 m black PUR cable	3 x 0.34 mm ² , Ø 4.9 mm	TPU / Brass	10...36 DC	-25...90	IP 65 / IP 67 / IP 68 / IP 69K	green / yellow	3	EVC439

Jumpers for hygienic and wet areas

Type	Cable	Wire specification	Material housing / nut	U [V]	T _a [°C]	Protection	LEDs	Drawing no.	Order no.
Group 137 · Y connection cable , plug: M12, 5-pole, socket: M12, 5-pole, 5-wire · Wiring diagram no. 1									
	1 m orange PVC cable	4 x 0.34 mm ² , Ø 4.9 mm	PVC / stainless steel 316L / 1.4404	60 AC 60 DC	-25...100	IP 65 / IP 67 / IP 68 / IP 69K	-	4	EVT329
	2 m orange PVC cable	4 x 0.34 mm ² , Ø 4.9 mm	PVC / stainless steel 316L / 1.4404	60 AC 60 DC	-25...100	IP 65 / IP 67 / IP 68 / IP 69K	-	4	EVT330
	5 m orange PVC cable	4 x 0.34 mm ² , Ø 4.9 mm	PVC / stainless steel 316L / 1.4404	60 AC 60 DC	-25...100	IP 65 / IP 67 / IP 68 / IP 69K	-	4	EVT331
	1 m orange PVC cable	4 x 0.34 mm ² , Ø 4.9 mm	PVC / stainless steel 316L / 1.4404	60 AC 60 DC	-25...100	IP 65 / IP 67 / IP 68 / IP 69K	-	5	EVT332
	2 m orange PVC cable	4 x 0.34 mm ² , Ø 4.9 mm	PVC / stainless steel 316L / 1.4404	60 AC 60 DC	-25...100	IP 65 / IP 67 / IP 68 / IP 69K	-	5	EVT333
	5 m orange PVC cable	4 x 0.34 mm ² , Ø 4.9 mm	PVC / stainless steel 316L / 1.4404	60 AC 60 DC	-25...100	IP 65 / IP 67 / IP 68 / IP 69K	-	5	EVT334

Group 139 · Y connection cable , plug: M12, 4-pole, socket: M12, 5-pole, 5-wire, LED, PNP · Wiring diagram no. 2									
	1 m orange PVC cable	3 x 0.34 mm ² , Ø 4.9 mm	PVC / stainless steel 316L / 1.4404	10...36 DC	-25...100	IP 65 / IP 67 / IP 68 / IP 69K	green / yellow	6	EVT335
	2 m orange PVC cable	3 x 0.34 mm ² , Ø 4.9 mm	PVC / stainless steel 316L / 1.4404	10...36 DC	-25...100	IP 65 / IP 67 / IP 68 / IP 69K	green / yellow	6	EVT336
	5 m orange PVC cable	3 x 0.34 mm ² , Ø 4.9 mm	PVC / stainless steel 316L / 1.4404	10...36 DC	-25...100	IP 65 / IP 67 / IP 68 / IP 69K	green / yellow	6	EVT337

Wiring diagrams

1

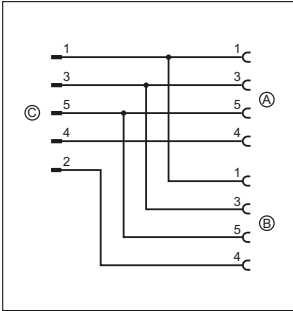

2

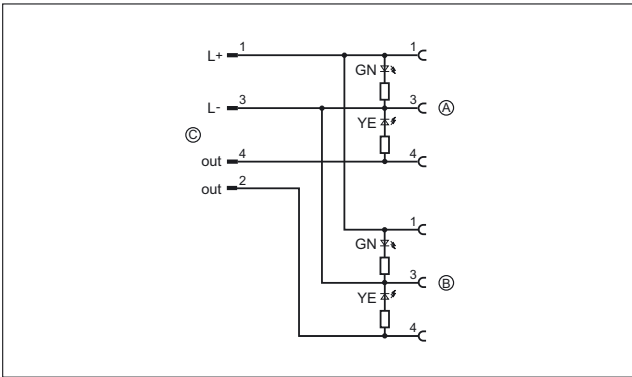

Scale drawings / drawing no. – CAD download: www.ifm.com

1

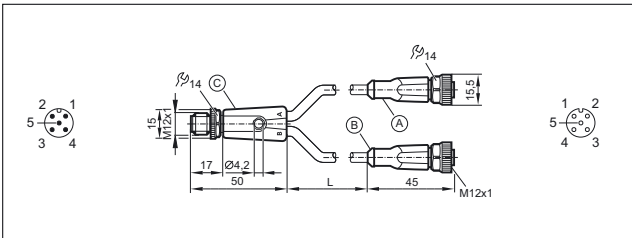

4

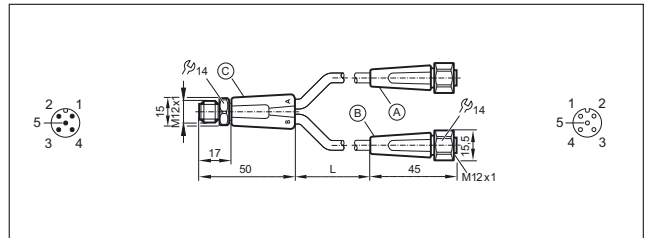

2

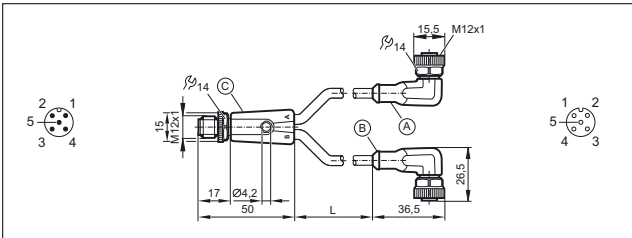

5

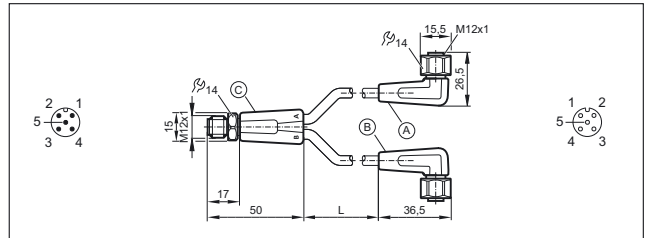

3

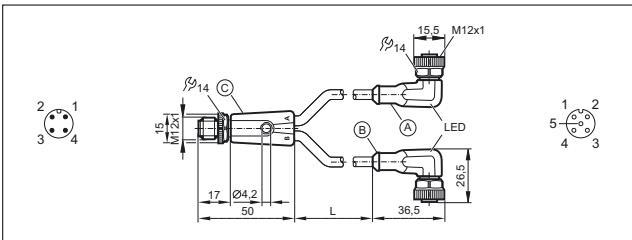

6

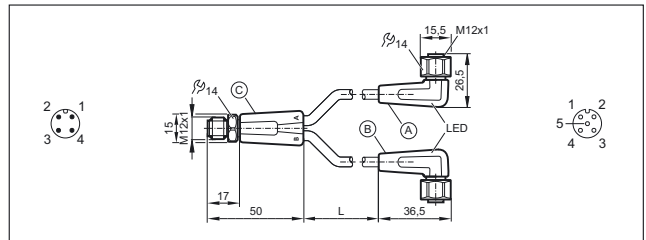



Voltage guaranteed



Suitable for the application: ifm provides power supplies in different power classes.



Power supplies

Transformer power supplies provide a low voltage, normally 24 V DC. A transformer according to DIN 0551 ensures a safe electrical separation from mains voltage and low voltage. The output voltage can be regulated ($\pm 5\%$) or smoothed by means of capacitors. The different designs and output powers allow adaptation to diverse operating conditions.

Switched-mode power supplies

Primary switched-mode power supplies are a compact and economical solution to supply sensors and actuators. As opposed to conventional transformer power supplies with regulated output voltage primary switched-mode power supplies need no heavy transformers so that there are fewer iron and copper losses. They are therefore distinguished by a very high degree of efficiency of up to 95%. Due to the operating principle by means of high frequency transformers switched-mode power supplies are much smaller and lighter than transformer power supplies with identical power. Nevertheless they guarantee an electrical separation. Furthermore, they offer a wide input voltage range as standard, e.g. 100...240 or 323...576 V AC. This makes them fit for world-wide use. ifm switched-mode power supplies have a regulated output voltage of typ. 24 V DC with a tolerance of $\pm 2\%$. Apart from few exceptions the output voltage can be set between 24 V and 28 V to compensate for example for a voltage drop on long cables. Between no load and full load they ensure a stable supply voltage and thus operational reliability in case of supply voltage fluctuations.

Power reserves

Switched-mode power supplies from ifm are rated for permanent operation in the specified performance limits. This allows the power supplies to be used at full load over almost the complete temperature range. Moreover the power supplies feature an excess gain of 20% while reaching 100% switch-on time.

Mains fluctuations and interference are compensated for. Even mains voltage dips of a few milliseconds are compensated for, the output voltage is completely maintained.

An inrush current limitation actively reduces the peak inrush current and thus enables the use of common automatic circuit breakers.

The outputs are protected against short circuits and overload.



24 V DC power supplies

832 - 836



AS-i power supplies

838 - 840





24 V DC power supplies

These high-quality 24V switched-mode power supplies excel by their wide range of performance. Flexible one-phase or three-phase primary voltages with wide-range inputs can be used worldwide. Degrees of efficiency of up to 94 percent ensure that the control cabinet only heats up slightly. The units are protected against overvoltage and permanent short circuit.

System overview	Page
Power supplies / switching amplifiers with one output	832
Power supplies / switching amplifiers with 2 inputs and 2 outputs	832
Power supplies / switching amplifiers with on and off delay with external output	833
Switched-mode power supplies, single phase, in compact plastic housing	833
Standard switched-mode power supplies, single phase, in robust metal housing	833
Standard switched-mode power supplies, two-phase, in robust metal housing	833
Standard switched-mode power supplies, three-phase, in robust metal housing	834
Scale drawings / drawing no. – CAD download: www.ifm.com	834 - 836

Power supplies / switching amplifiers with one output

Type	Current [mA]	Output voltage [V]	Nominal voltage [V]	Output	Drawing no.	Order no.
	–	24 DC SELV, ± 10 %, 300 mA	110...240 AC	relay (1 changeover contact)	1	DN0210



Power supplies / switching amplifiers with 2 inputs and 2 outputs

Type	Current [mA]	Output voltage [V]	Nominal voltage [V]	Output	Drawing no.	Order no.
	–	24 DC SELV, ± 10 %, 2 x ≤ 150 mA	110...240 AC	2 relays (1 changeover contact per channel)	2	DN0220



Power supplies / switching amplifiers with on and off delay with external output

Type	Current [mA]	Output voltage [V]	Nominal voltage [V]	Output	Drawing no.	Order no.
	max. 40	24 DC $\pm 5\%$	230 AC (50...60 Hz) / 24 DC	relay (1 changeover contact)	3	DT0001

Switched-mode power supplies, single phase, in compact plastic housing

Type	Current [A]	Output voltage [V]	Nominal voltage [V]	Mains buffering time [ms]	Efficiency typ. [%]	Drawing no.	Order no.
	1.25	24...28	115 / 230 AC	120 (230 V AC; 24 V DC; 1.25 A)	84	4	DN1030
	2.5	24...28	115 / 230 AC	90 (230 V AC; 24 V DC; 2.5 A)	88	4	DN1031
	4.1	24...28 DC ($\pm 2\%$)	115 / 230 AC	> 40 (230 V AC; 24 V DC / 4.1 A)	90	5	DN1022



Standard switched-mode power supplies, single phase, in robust metal housing

Type	Current [A]	Output voltage [V]	Nominal voltage [V]	Mains buffering time [ms]	Efficiency typ. [%]	Drawing no.	Order no.
	3.3	24...28 DC	115 / 230 AC	30 (120 V AC; 60 Hz) / 128 (230 V AC; 50 Hz)	88	6	DN4011
	5	24...28 DC	115 / 230 AC	80 (120 V AC; 60 Hz) / 78 (230 V AC; 50 Hz)	89.4	6	DN4012
	10	24...28 DC	115 / 230 AC	46 (120 V AC; 60 Hz) / 47 (230 V AC; 50 Hz)	91	7	DN4013
	20	24...28 DC	115 / 230 AC	26 (120 V AC; 60 Hz) / 26 (230 V AC; 50 Hz)	92.7	8	DN4014

Standard switched-mode power supplies, two-phase, in robust metal housing

Type	Current [A]	Output voltage [V]	Nominal voltage [V]	Mains buffering time [ms]	Efficiency typ. [%]	Drawing no.	Order no.
	5	24...28 DC	2 x 400 AC	27 (400 V AC; 50 Hz) / 48 (480 V AC; 60 Hz)	90.4	9	DN4032

Standard switched-mode power supplies, three-phase, in robust metal housing

Type	Current [A]	Output voltage [V]	Nominal voltage [V]	Mains buffering time [ms]	Efficiency typ. [%]	Drawing no.	Order no.
	10	24...28 DC	3 x 400 AC	34 (400 V AC; 50 Hz) / 54 (480 V AC; 60 Hz)	92.8	10	DN4033
	20	24...28 DC	3 x 400 AC	22 (400 V AC; 50 Hz) / 22 (480 V AC; 60 Hz)	95	11	DN4034
	40	24...28 DC (±2%)	3 x 400...500 AC	> 15	92.5	12	DN2035
	30	24...28 DC (±2%)	3 x 400...500 AC	> 10	93	13	DN2036

Scale drawings / drawing no. – CAD download: www.ifm.com

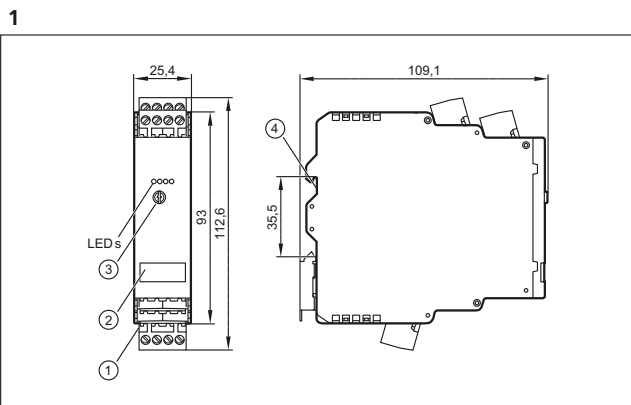

1: plug-in screw terminals, 2: label, 3: potentiometer, 4: Mounting on DIN rail

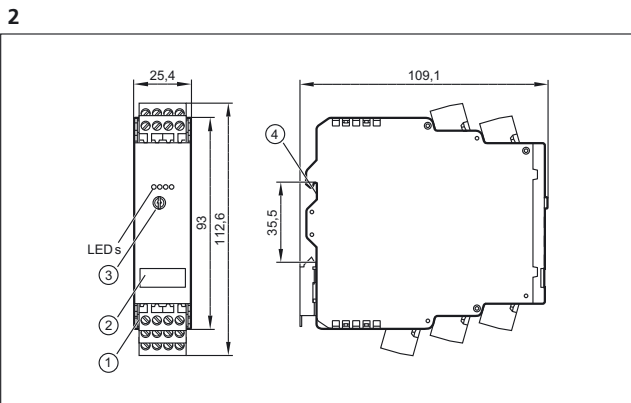

1: plug-in screw terminals, 2: label, 3: potentiometer, 4: Mounting on DIN rail

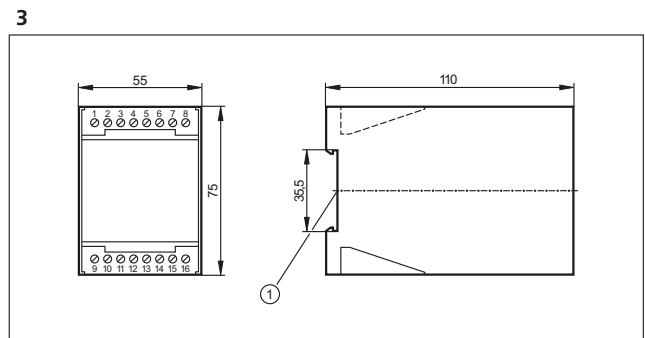

1: Mounting on DIN rail

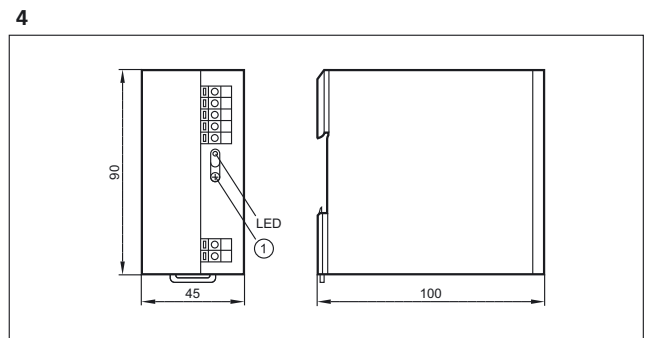

1: potentiometer

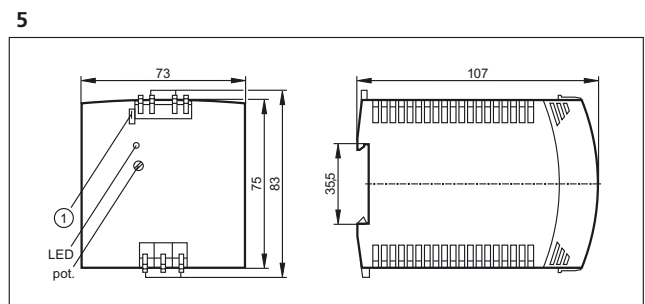

1: jumper "single/parallel operation"

Scale drawings / drawing no. – CAD download: www.ifm.com

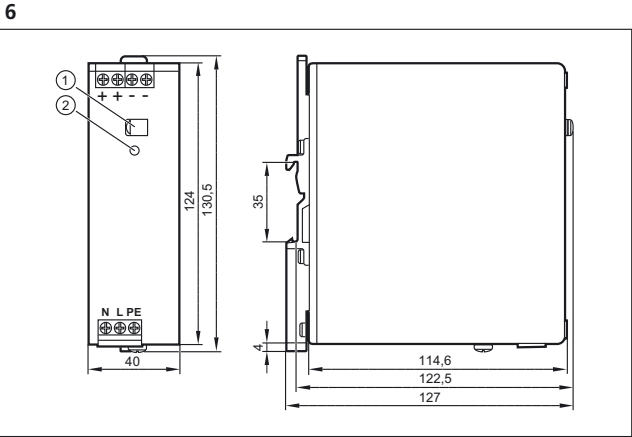

1: Potentiometer 24...28 V DC, 2: LED DC ok

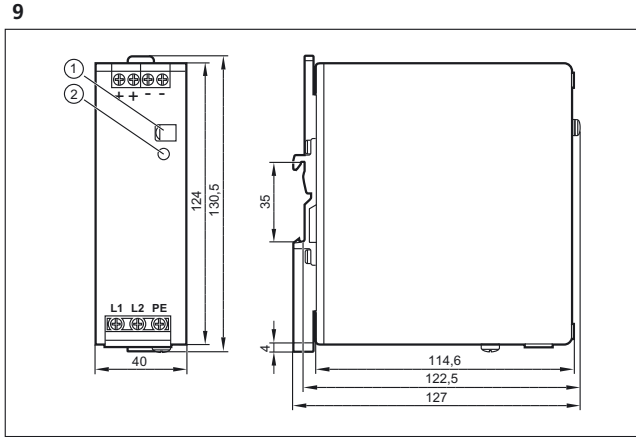

1: Potentiometer 24...28 V DC, 2: LED DC ok

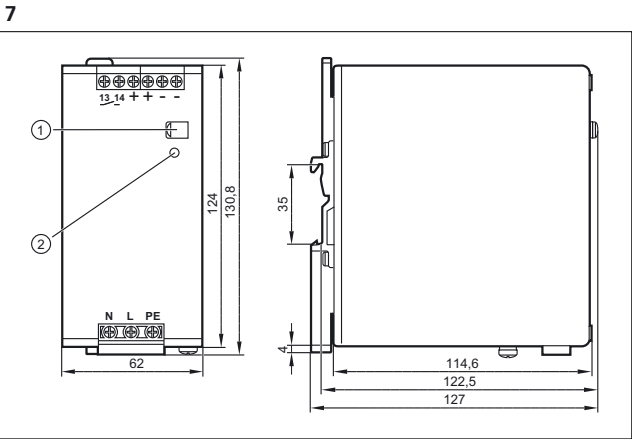

1: Potentiometer 24...28 V DC, 2: LED DC ok

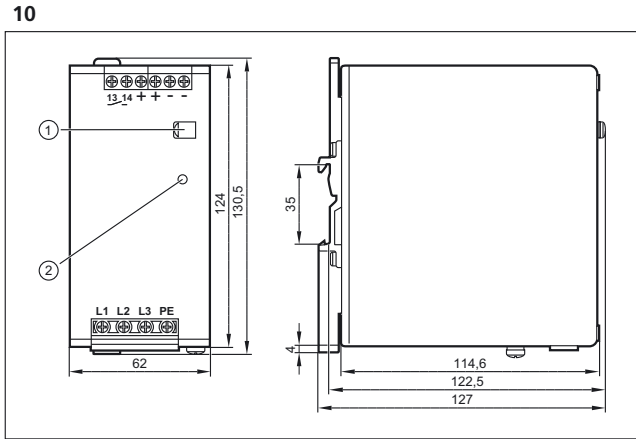

1: Potentiometer 24...28 V DC, 2: LED DC ok

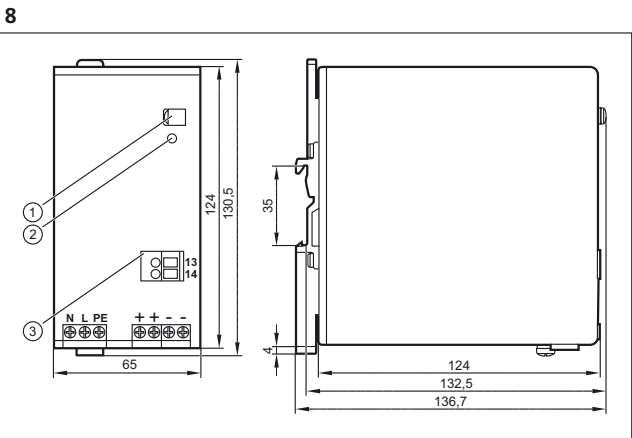

1: Potentiometer 24...28 V DC, 2: LED DC ok, 3: Terminals DC OK signal

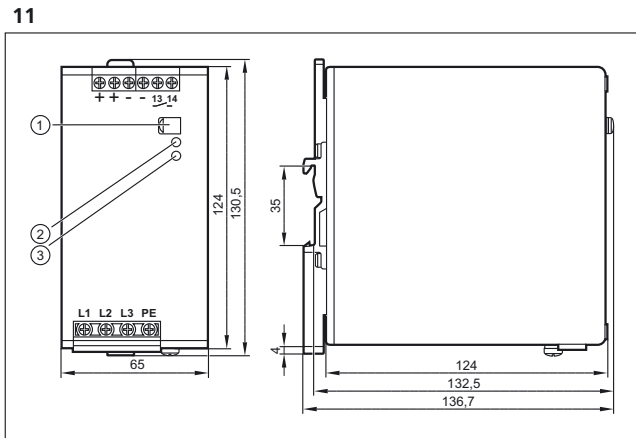

1: Potentiometer 24...28 V DC, 2: LED DC ok, 3: LED Overload

Scale drawings / drawing no. – CAD download: www.ifm.com

12

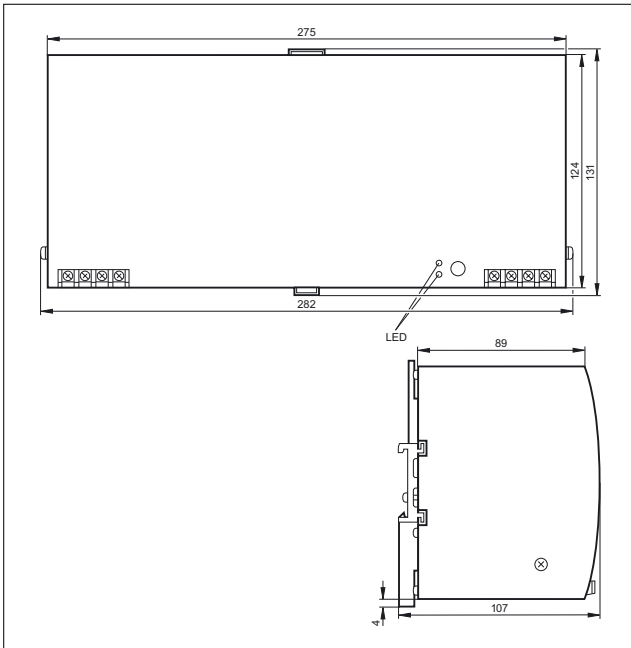

13

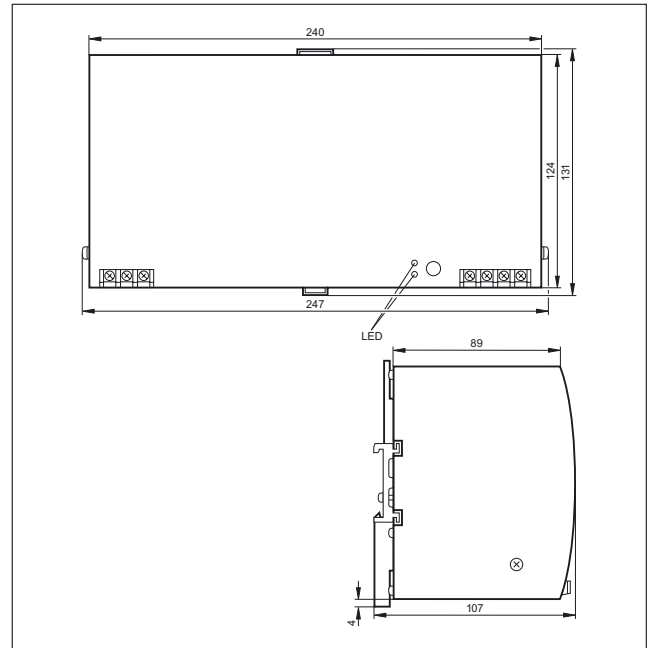







AS-i power supplies

All AS-i power supplies are primary switched-mode power supplies with a high degree of efficiency. The robust DIN rail housing can be easily integrated in large control cabinets as well as in local boxes. The primary voltage range stretches from 24 V DC via 230 V AC up to 400 V AC three-phase and can consequently be adapted to the local conditions.

System overview	Page
AS-i switched-mode power supplies, single phase, in robust metal housing	838
AS-i switched-mode power supplies, single phase, in compact plastic housing	838
AS-i switched-mode power supplies, three phase, in robust metal housing	839
DC / DC converter (24 V / AS-i), in robust metal housing	839
Scale drawings / drawing no. – CAD download: www.ifm.com	839 - 840

AS-i switched-mode power supplies, single phase, in robust metal housing

Type	Current [A]	Output voltage [V]	Nominal voltage [V]	Mains buffering time [ms]	Efficiency typ. [%]	Drawing no.	Order no.
	2.8	30.5 DC	115 / 230 AC	98 (120 V AC; 60 Hz) / 96 (230 V AC; 50 Hz)	86.9	1	AC1256
	4	30.5 DC	115 / 230 AC	70 (120 V AC; 60 Hz) / 70 (230 V AC; 50 Hz)	88	1	AC1254
	8	30.5 DC	115 / 230 AC	44 (120 V AC; 60 Hz) / 42 (230 V AC; 50 Hz)	89.4	2	AC1258

AS-i switched-mode power supplies, single phase, in compact plastic housing

Type	Current [A]	Output voltage [V]	Nominal voltage [V]	Mains buffering time [ms]	Efficiency typ. [%]	Drawing no.	Order no.
	0.95	29.5...31.6 DC	100...240 AC	120 (230 V AC)	86	3	AC1220
	1.9	29.5...31.6 DC	100...240 AC	90 (230 V AC)	88	3	AC1221

AS-i switched-mode power supplies, three phase, in robust metal housing

Type	Current [A]	Output voltage [V]	Nominal voltage [V]	Mains buffering time [ms]	Efficiency typ. [%]	Drawing no.	Order no.
	8	30.5 DC	3 x 400 AC	34 (400 V AC; 50 Hz) / 53 (480 V AC; 60 Hz)	92	4	AC1253

DC / DC converter (24 V / AS-i), in robust metal housing

Type	Current [A]	Output voltage [V]	Nominal voltage [V]	Mains buffering time [ms]	Efficiency typ. [%]	Drawing no.	Order no.
	4	30.5 DC	24 DC	6 (24 V DC)	90.5	5	AC1257

Scale drawings / drawing no. – CAD download: www.ifm.com

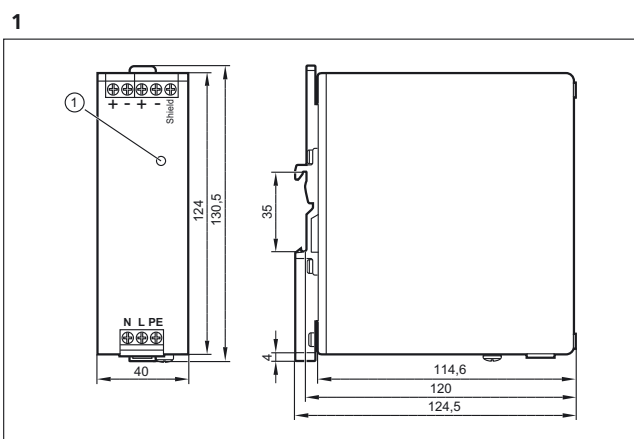

1: LED AS-i ok

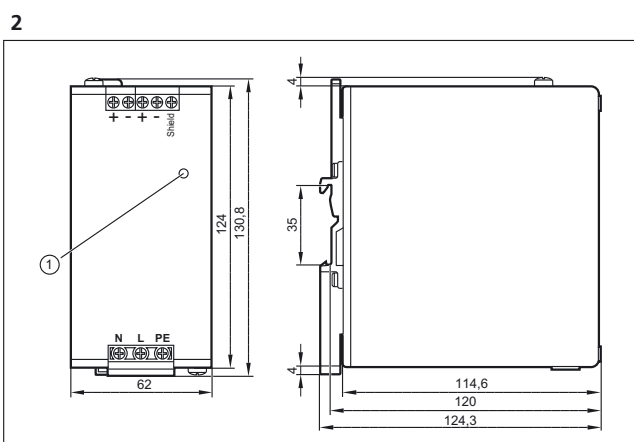

1: LED AS-i ok

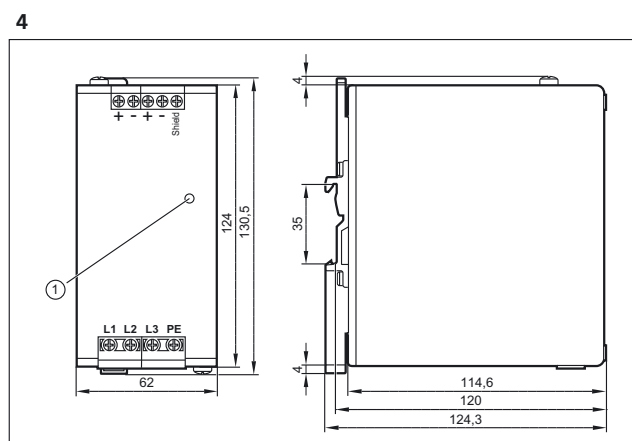
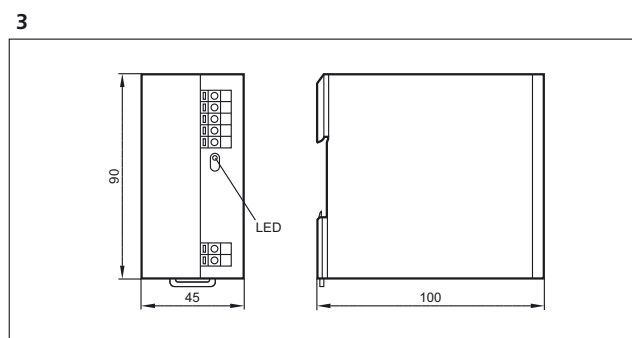

1: LED AS-i ok

Scale drawings / drawing no. – CAD download: www.ifm.com

5

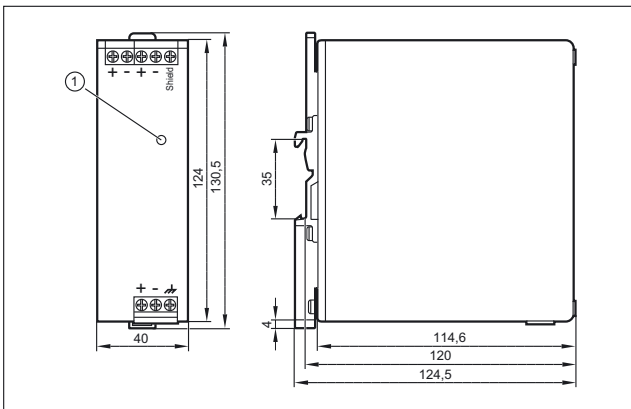

1: LED AS-i ok



Algeria

**Sarl AMS Algérie - Automatismes
Motorisation & Services**
Lotissement C, lot n°190 B
Draria - 16000 ALGER
Tel. +213 (0)5 59 43 45 22
Tel. +213 (0) 23 26 41 45
Fax +213 (0)23 26 42 58
contact@amsalgérie.com
www.amsalgerie.com

Argentina

ifm electronic s.r.l.
Lola Mora 421
10° piso, oficina 3
1107 - Puerto Madero
Ciudad Aut. Buenos Aires
Tel./Fax +54 (011) 5353-3436
Interior del país: 0810-345-3436
info.ar@ifm.com
www.ifm.com/ar

Australia

ifm efector Pty Ltd.
PO Box 479
Suite 3, 745 Springvale Road
Mulgrave VIC 3170
Tel. 1300 365 088
Fax 1300 365 070
sales.au@ifm.com
www.ifm.com/au

Austria

ifm electronic gmbh
Wienerbergstraße 41
Gebäude E
1120 Vienna
Tel. +43 / 1 / 617 45 00
Fax +43 / 1 / 617 45 00 10
info.at@ifm.com
www.ifm.com/at

Bangladesh

Sensotec Automation and Control
5, New Eskaton Road
Ghausnagar, Ramna
Dhaka 1000 Bangladesh
Tel. +880 171 154 689 0
sensotec@agni.com

Belarus

ifm electronic
ELTICON Trade House Ltd.
2A Ostroshitskaya st.
220125 Minsk, Belarus
Tel.: +375-17-286-4649
Fax: +375-17-289-6169
E-mail: info@elticon.ru
www.elticon.ru

MilkGroup LLC.

220015 Minsk, Belarus
Ponomarenko str., 35A, office 517
Tel./Fax: +375 17 207 29 34
E-mail: ifm@milkgroup.by
www.milkgroup.by

FilFar Technology LLC

Zapadnaya str., 13, office 519
220036 Minsk, Belarus
Tel.: +375 (44) 540-40-40
E-mail: zapros@filfar.by
www.filfar-technology.by

Belgium and Luxembourg

ifm electronic n.v./s.a.
Zuiderlaan 91 - B6
1731 Zellik
Tel. +32 2 481 0220
Fax +32 2 463 1795
info.be@ifm.com
www.ifm.com/be

Bolivia

**BAVARIA S.R.L.
Álvaro Baptista Vargas**
Zona Calacoto Alto, Urb. Morocollo -
Santos Paríamo
C. Mario Diaz de medina (26-A), n° 32
La Paz
Tel. 00-591-2-279 269 1
Mobile 00-591-720-47 442
PoBox N°312248
alvarobaptista@bavaria.bo
www.bavaria.bo

Brazil

ifm electronic Ltda.
Rua Leonora Cintra, 140
Jardim Analia Franco
03337-000 São Paulo
Tel. +55-11-2672-1730
Fax +55-11-2673-3501
info.br@ifm.com
www.ifm.com/br

Bulgaria

ifm electronic eood
1202 Sofia
ul. Klokotnica No 2A
Business Centre IVEL
fl.4, office 17
Tel. +359 2 807 59 69
Fax +359 2 807 59 60
info.bg@ifm.com

Canada

ifm efector Canada Inc.
2233 Argentinia Road, Suite 104
Mississauga, ON L5N 2X7
Tel. 855-436-2262
Fax 855-399-5099
info.ca@ifm.com
www.ifm.com/ca

Chile

ifm electronic SpA
Presidente Eduardo Frei Montalva
6199, Oficina 5032
Comuna de Conchalí
Región Metropolitana
Tel.: +56-2-32239282
info.cl@ifm.com

China

ifm electronic (Shanghai) Co., Ltd
Building 15,
No. 1000, Zhangheng Road,
Pu Dong District.
201203 Shanghai, P.R.China
Tel. +86 21 3813 4800
Fax +86 21 5027 8669
400 National Service Hotline:
400 880 6651
Involving: Contact quotation, Product
delivery, Technical support, etc
info.cn@ifm.com
www.ifm.com/cn

ifm electronic (HK) Ltd

Unit 2106, 21/F,
Tower 2, Metroplaza
No. 223 Hing Fong Road,
Kwai Chung,
N.T., Hong Kong.
info.hk@ifm.com
www.ifm.com/hk

ifm electronic (Taiwan) Limited

9F.-6, No.12, Fuxing 4th Rd., Cianjhen
District, Kaohsiung City,
Postal Code 806, Taiwan, R.O.C.
Tel. +886-7-335-7778
Fax +886-7-335-6878
info.tw@ifm.com
www.ifm.com/tw

Columbia

SENSOMATIC Y CIA LTDA.
Calle 1 C 25a - 50
Bogotá D.C.
Tel. +57 313 430 2264
Tel. +57 1 407 96 96
info@sensomatic-ltda.com
www.sensomatic-ltda.com

Costa Rica

Gen Bus S.A
Santa Rosa, Sto. Domingo, Heredia.
Bodegas Del Sol, Bodega n° 22
Tel. + (506) 25 60 39 58
Tel. + (506) 22 62 39 27
Fax + (506) 22 62 16 74

Croatia

ifm electronic gmbh
Wienerbergstr. 41
Gebäude E
1120 Wien
Tel. +43 / 1 / 617 45 00
Fax +43 / 1 / 617 45 00 10
info.hr@ifm.com
www.ifm.com/hr

Czech Republic

ifm electronic, spol. s r.o.
U Křížku 571
252 43 Prague
Tel. +420 267 990 211
Fax +420 267 750 180
info.cz@ifm.com
www.ifm.com/cz

Denmark

ifm electronic a/s
Ringager 4A
2605 Brøndby
Tel. +45 70 20 11 08
info.dk@ifm.com
www.ifm.com/dk

Dominican Republic

WECH AUTOCONTROLES S. A.
Ave. Romulo Betancourt 2158
Edificio Wech
Urb. Renacimiento
Santo Domingo
Tel. + 1 809-531-0550
Fax + 1 809-531-9175
wech@verizon.net.do
www.wechautocontroles.com.do

Ecuador

INSELEC CIA. LTDA.
Av. de los Arupos
E1-202 y Pan. Norte- Km 5 ½
Quito
Tel. +593 2 28074- 76 - 78
Fax +593 2 2807475
inselec@inselec.com.ec
www.inselec.com.ec

Egypt

**Egyptian Establishment for
Electromechanical Supplies**
Mr. Ahmed Gouda
27 Al-Salam Street
Al Arezona, Al Haram Road
Giza 12111, Cairo
Tel. +20 / 2 / 586 49 49
Fax +20 / 2 / 586 49 49
Mobile +20 10 10 61 791
ahmed_gouda97@yahoo.com

El Salvador

Provinter
Prolongación Boulevard Constitución,
Residencial la Gloria,
Block C-3 pje. 2-C, N*1 Mejicanos,
San Salvador, El Salvador
Tel. + (503) 25643005
Ventas@provinter.com

Estonia

Pesmel Estonia LTD
Segu 4
76505 Saue
Tel. +372 674 73 30
Fax +372 674 73 31
pesmel@pesmel.ee
www.pesmel.ee

Finland

ifm electronic oy
Vaakatie 5
00440 Helsinki
Tel. +358 (0)75 329 5000
Fax +358 (0)75 329 5010
info.fi@ifm.com
www.ifm.com/fin

France

ifm electronic
Siège :
Savoie Technolac BP226
73374 Le Bourget du Lac
Agence commerciale :
Immeuble Uranus
1-3 rue Jean Richepin
93192 NOISY LE GRAND CEDEX
Tel. 0820 22 30 01
Fax 0820 22 22 04
info.fr@ifm.com
www.ifm.com/fr

Germany

ifm electronic gmbh
Friedrichstr. 1
45128 Essen
Tel. +49 201 24 22 0
Fax +49 201 24 22 12 00
info@ifm.com
www.ifm.com/de

Greece

ifm electronic monoprosopi E.P.E.
27, Andrea Papandreou Street
15125 Amaroussi
Tel. +30 210 61 800 90
Fax +30 210 61 994 00
info.gr@ifm.com
www.ifm.com/gr

Guatemala

Ingenieros Civiles Electromecánicos Asociados, S.A. (IASA)
20 Calle 25-55 Zona 12
Empresarial El Cortijo III Bodega n° 907,
Guatemala City
Tel. +502-23061300
info@iasa.com.gt

Honduras

R y D INDUSTRIAL
Bo. Paz Barahona
11 Ave. 14 y 15 Calle
S.O. #142
San Pedro Sula
Tel. +(504) 2550-3703
Tel. +(504) 2558-9313
ventas@rydindustrial.com

Hungary

ifm electronic kft.
Szent Imre út 59. I.em.
H-9028 Győr
Tel. +36-96 / 518-397
Fax +36-96 / 518-398
info.hu@ifm.com
www.ifm.com/hu

India

ifm electronic India Private Limited
Plot No. P-39/1
MIDC Gokul Shirgaon
Kolhapur – 416234
Maharashtra State
Tel. +91 / 231 / 267 27 70
Fax +91 / 231 / 267 23 88
info@ifm-electronic.in
www.ifm.com/in

Indonesia

PT Indoserako Sejahtera
Jl. P. Jayakarta 121 No. 59
10730 Jakarta Pusat
Tel. +62 / 21 6 24 8923
Fax +62 / 21 6 24 8922
harry@indoserako.com

Ireland

ifm electronic (Ireland) Ltd.
No. 7, The Courtyard
Kilcarbery Business Park
New Nangor Road
Clondalkin
Dublin 22
Tel. +353 / 1 / 461 32 00
Fax +353 / 1 / 457 38 28
sales_ie@ifm.com
www.ifm.com/ie

Israel

Astragal Ltd.
3, Hashikma Str.
Azur 58001
P.O. Box 99
Azur 58190
Tel. +972 / 3 / 5 59 16 60
Fax +972 / 3 / 5 59 23 40
astragal@astragal.co.il
www.astragal.co.il

Italy

ifm electronic
Centro Direzionale Colleoni
Palazzo Andromeda 2
Via Paracelso n. 18
20864 Agrate Brianza (MB)
Tel. +39 (0)39-6899982
Fax +39 (0)39-6899995
info.it@ifm.com
www.ifm.com/it

Japan

efector co. ltd.
18F WBG Marive-west
2-6-1 Nakase, Mihama-ku
Chiba-shi, Chiba 261-7118
info.jp@ifm.com
www.ifm.com/jp

Jordan

Al Mashreqan Trading Supplies
P.O.Box.851054
11185 Swaifieh
Amman
Tel. +962 6 581 8841
Fax +962 6 581 8892
info@mashreqan.com

Korea

ifm electronic Ltd.
Hyundai Liberty House 201
Dokseodang-ro Yongsan-Gu
04420 Seoul
Tel. +82 2-790-5610
Fax +82 2-790-5613
info.kr@ifm.com
www.ifm.com/kr

Kuwait

Kana Controls
2nd Floor Khalid Fauzan Building
Building No. 1670
Street No. 7, Block No. 1
Al-Rai Industrial Area,
P.O. Box - 25593,
13116 Safat
Tel. +965-24741537
Fax +965-24741537
info@kanacontrols.com
www.kanacontrols.com

Latvia

EC Systems
Katlakalna Str. 4A
1073 Riga
Tel. +371 724 1231
Fax +371 724 8478
alnis@ecsystems.lv
www.ecsystems.lv

Lebanon

Middle East Development Co. SAL (MEDEVCO)
Medevco Building
Jeita Main Road
Jeita - Kesrouan, Lebanon
Mail address :
P.O.Box 67
Jounieh
Lebanon
Tel. +961-9-233550
Fax +961-9-233554
info@medevco-lebanon.com

Lithuania

Elinta UAB
Terminalo g. 3, Biruliškių k.,
Karmėlavos sen.
LT-54469 Kauno raj. (Kauno LEZ)
Tel. +370 37 351 999
Fax +370 37 452 780
sales@elinta.lt
www.elintosprekyba.lt

Malaysia & Singapore

ifm electronic Pte. Ltd
Malaysian Branch Office
No. 9F – 2A, 9th Floor,
Tower 4 @ PFCC, Jalan Puteri 1/2,
Bandar Puteri Puchong,
47100 Puchong, Selangor
Tel. + 603 8066 9853
Fax + 603 8066 9854
sales.my@ifm.com
www.ifm.com/my

Singapore Branch Office
25, International Business Park
#03-26/29 German Center
609916 Singapore
Tel. +6565628661
Fax +6565628660
sales.sg@ifm.com
www.ifm.com/sg

Mexico

ifm efector S. de R.L. de C.V.
Ave. Arq. Pedro Ramirez Vázquez 200-4
Planta Baja, Col. Valle Oriente.
San Pedro Garza Garcia, N.L. 66269
Tel. +52-81-8040-3535
Fax +52-81-8040-2343
clientes.mx@ifm.com
www.ifm.com/mx

Morocco

SOFIMED
137, Boulevard Moulay Ismail -
Roches Noires
20290 - Casablanca
Tel. +212 522 240 101
Fax +212 522 240 100
www.sofimed.ma

Namibia

ifm electronic (pty) Ltd
1 Basement Office,
Decor House
25 Dr. W. Kulz Street
Windhoek
Namibia
Tel. +264 61 300984 / 300998
Fax +264 61 300910
Fax to email +264 88 651 9943
info.na@ifm.com
www.ifm.com/na

Netherlands

ifm electronic b.v.
Deventerweg 1 E
3843 GA Harderwijk
Tel. +31 / 341 438 438
Fax +31 / 341 438 430
info.nl@ifm.com
www.ifm.com/nl

New Zealand

ifm efector pty ltd.
Unit 13, 930 Great South Road
Penrose, Auckland
Tel. +64 / 95 79 69 91
Fax +64 / 95 79 92 82
sales.nz@ifm.com
www.ifm.com/nz

Nigeria

Automated Process Ltd
3rd Floor, 32 Lagos Abeokuta
Expressway
Near Cement Bus Stop
Dopemu, Agege
Lagos State
Tel. + 234 / 01 / 4729 967
Fax + 234 / 01 / 4925 865
sales@automated-process.com
www.automated-process.com

Norway

Siv.Ing. J.F.Knudtzen AS
Billingstadsletta 97
1396 Billingstad
Postboks 160
1378 Nesbru
Tel. +47 / 66 98 33 50
Fax +47 / 66 98 09 55
firmapost@jfknudtzen.no
www.jfknudtzen.no

Oman

Technical Engineering Company LLC.
P.O. Box 59
Madinat Al Sultan Qaboos
Postal Code 115
Tel. +968 24503593
Fax +968 24503573
tecoman@omantel.net.om

Panama

JDA Ingeniería
Dirección: Edificio Diamante 3, 3A,
Villa De Las Fuentes 1.
Ciudad de Panamá.
Tel: (507) 399-8200/ 6200-4205
jaguilar@daingenieria.com
www.jdaingenieria.com

Peru

dekatec s.a.c.
Los Calderos 188
Urb. Vulcano, Ate
Lima
Tel. +511 / 348 0293
Tel. +511 / 348 0458
Tel. +511 / 348 2269
Fax +511 / 349 0110
dkleffmann@dekatec.com.pe
www.dekatec.com.pe

Philippines

Gram Industrial, Inc.
Bldg. 9 Don Mariano Lim
Industrial Complex,
Alabang Zapote Road
corner Concha Cruz Drive,
Brgy. Almanza 1 Las Piñas City
Tel. 632-8502218 / 8508496
Fax 632-8077173 / 8503055
bongalido@gram.com.ph

Poland

ifm electronic Sp.z o.o.
ul. Weglowa 7
PL 40-105 Katowice
Tel. +48 32 70 56 454
Tel. +48 32 70 56 480
Fax +48 32 70 56 455
info.pl@ifm.com
www.ifm.com/pl

Portugal

ifm electronic s.a.
Parque Tecnológico S. Félix da Marinha
Avenida Manuel Violas, 476
4410-137 São Félix da Marinha
Tel. +351 22 37 17 108
Fax +351 22 37 17 110
info.pt@ifm.com
www.ifm.com/pt

Qatar

Advanced Fluid Power L.L.C
P.O. Box 201382
Barwa Village Al Wakra
Building No 1
Doha-Qatar
Tel. +974-40164275
Fax +974-40164274
sales@afp-qatar.com
www.afp-qatar.com

Romania

ifm electronic s.r.l.
Mihai Viteazu Str. Nr. 1
Selimbar, Sibiu
557260
Tel. 0040 269 224550
Fax 0040 269 224766
info.ro@ifm.com

Russia

ifm electronic
Ibragimova, 31, k.50
office 808
105318 Moscow
Tel. +7 (495) 921-44-14
Fax +7 (495) 651-82-97
info.ru@ifm.com
www.ifm.com/ru

Saudi Arabia

**Noor Al-Shomoe for
Electric & Maintenance**
King Khalid Street, Cross 5
P.O. Box 2571
Al-Khobar 31952
Kingdom of Saudi Arabia
Tel. +9 663 864 49 58
Fax +9 663 894 63 41
h.o.info@nooralshomoe.com

**Bariq Al Emdadat Trading
Establishment**

P.O. Box 27001, Riyadh 11653
Kingdom of Saudi Arabia
Contact: Abdul Aziz Mohamed Elias
Tel. +966 11 4728782
Fax +966 11 4725576
Mobile 00966 53 2626686
azizelias@bariqarabia.com

Singapore

ifm electronic Pte. Ltd.
25, International Business Park
#03-26/29 German Center
609916 Singapore
Tel. +6565628661
Fax +6565628660
sales.sg@ifm.com
www.ifm.com/sg

Slovakia

ifm electronic spol. s.r.o.
Rybnicna 40
831 06 Bratislava
Tel. +421 / 2 / 44 87 23 29
Fax +421 / 2 / 44 64 60 42
info.sk@ifm.com
www.ifm.com/sk

South Africa

ifm electronic (pty) Ltd
112 Sovereign Drive,
Route 21 Corporate Park
Centurion
0157
Postnet Suite 279
Private Bag X8
Elardus Park
0047
National: 0861 IFM RSA (436 772)
International: +27 12 450 0400
Fax +27 12 450 0412
info.za@ifm.com
www.ifm.com/za

Spain

ifm electronic s.l.
Parc Mas Blau
Edificio Inbisa
c/ Garrotxa 6-8
08820 El Prat de Llobregat
Tel. 0034 93 479 30 80
Fax 0034 93 479 30 86
info.es@ifm.com
www.ifm.com/es

Sri Lanka

Isaro Automation Systems Ltd.
First Floor,
400 Galle Road,Rawathawatta.
Moratuwa
Tel. +94 114 216 784
Fax + 94 11 2644 224
isaro@slt.net.lk

Sweden

ifm electronic ab
Drakegatan 6
41250 Gothenburg
Tel. växel 031-750 23 00
Fax 031-750 23 29
info.se@ifm.com
www.ifm.com/se

Switzerland

ifm electronic ag
Altgraben 27
4624 Härkingen
Tel. 0800 88 80 33
Fax 0800 88 80 39
info.ch@ifm.com
www.ifm.com/ch

Thailand

SCM ALLIANZE CO., LTD.
700/19-24
Phaholyothin Road
Samsennai Phayatai
Bangkok 10400
Tel. +66 02 615 4888
contact@scma.co.th
www.scmallianze.com

Tunesia

TECHNOPREST
GP1 – Km 5,5 Rte de Sousse –
Z.I 2013 Ben Arous
Tel. +216 71 389 203
Fax + 216 71 389 215
technoprest@technoprest.com.tn

Turkey

**ifm electronic Elektrikli ve
Elektronik Aletler
İth.İhr.Paz.Tic.Ltd.Şti.**
Merkez Mah. Nadide Sok.
Anittepe Sitesi No:28
34381 Şişli / İstanbul
Tel. +90 / 212 / 210 5080
Fax +90 / 212 / 221 7159
info.tr@ifm.com
www.ifm.com/tr

Ukraine

ifm electronic
Mariny Raskovoj 11
02660 Kiev
Tel. +380 44 501 8543
Fax +380 44 501 8543
info.ua@ifm.com
www.ifm.com/ua

United Arab Emirates

Al Injazat Technical Services Est.
P.O. Box 42895
Al Qubaisi bldg floor 0 flat # 4
Liwa street corner of corniche road,
Abu Dhabi
Tel. +971-2-6585400
Fax +971-2-6585401
Mobil +971-50-6811072
kamran@injazat.ae
www.injazat.ae

United Kingdom

ifm electronic Ltd.
efector House
Kingsway Business Park
Oldfield Road
Hampton
Middlesex TW12 2HD
Tel. +44 / 20 / 8213 0000
Fax +44 / 20 / 8213 0001
enquiry_gb@ifm.com
www.ifm.com/uk

USA

ifm efector, inc.
1100 Atwater Dr.
Malvern, PA 19355
Tel. +1-800-441-8246
Fax +1-800-329-0436
info.us@ifm.com
www.ifm.com/us

Venezuela

Petrobornas, C.A.
C.C. Plaza Aeropuerto,
Galería piso 1, Local P1-B03,
Calle Neverí, Unare,
Puerto Ordaz 8050,
Estado Bolívar
Tel. + 58 286 9513382
info@petrobornas.net
www.petrobornas.net

Vietnam

**The Representative Office of
ifm electronic gmbh in
Ho Chi Minh City**
7A-7th Floor,
#467 Dien Bien Phu Street,
Ward 25, Binh Thanh District,
Ho Chi Minh City 700000
Tel. +84-8-35125177
Fax +84-8-35125178
sales.vn@ifm.com





ifm – close to you!